

TPS544x20 Step-Down Converter Evaluation Module User's Guide



ABSTRACT

The PWR-634EVM evaluation module uses either the TPS544C20 or TPS544B20 devices. The TPS544C20 and TPS544B20 are highly integrated synchronous buck converters that are designed for up to 30-A or 20-A current output, respectively.

Table of Contents

1 Description	2
1.1 Typical Applications	2
1.2 Features	2
2 Electrical Performance Specifications	3
3 Schematic	4
4 Test Setup	5
4.1 Test and Configuration Software	5
4.2 Test Equipment	6
4.3 The PWR-634EVM	7
4.4 Test Set up and USB Interface Adapter	8
4.5 List of Test Points	9
5 EVM Configuration Using the Fusion GUI	10
5.1 Configuration Procedure	10
6 Test Procedure	11
6.1 Line/Load Regulation and Efficiency Measurement Procedure	11
6.2 Efficiency	11
6.3 Equipment Shutdown	11
7 Performance Data and Typical Characteristic Curves	12
7.1 Efficiency	12
7.2 Load Regulation	12
7.3 Transient Response	13
7.4 Output Ripple	14
8 Screen Shots	17
8.1 Fusion GUI Screen Shots	17
9 EVM Assembly Drawing and PCB Layout	31
10 List of Materials	35
11 Revision History	37

1 Description

The PWR-634EVM is designed as a single output DC-DC converter that demonstrates either the TPS544C20 or the TPS544B20 in a typical low-voltage application while providing a number of test points to evaluate the performance. It uses a nominal 12-V input bus to produce a regulated 1.0-V output at up to either 30-A or 20-A of load current, depending on the device installed.

1.1 Typical Applications

- High-Density Power Solutions
- Communications equipment
- Servers and Computing equipment
- Smart Power Systems

1.2 Features

- Regulated 1.0-V output up to 30-ADC, steady-state output current
- Output is marginable and trimmable via the PMBus interface.
 - Programmable: UVLO, Soft Start, and Enable via the PMBus interface
 - Programmable overcurrent warning and fault limits and programmable response to faults via the PMBus interface
 - Programmable overvoltage warning and fault limit and programmable response to faults via the PMBus interface
 - Programmable high- and low-output margin voltages with a maximum range of 10%, –20% of nominal output voltage
- Convenient test points for probing critical waveforms

2 Electrical Performance Specifications

Table 2-1. PWR-634EVM Electrical Performance Specifications

PARAMETER	TEST CONDITIONS	MIN	TYP	MAX	UNITS
Input Characteristics					
Voltage range	V_{IN}	8	12	14	V
Maximum input current	$V_{IN} = 8\text{ V}$, $I_O = 30\text{ A}$,			5	A
No load input current	$V_{IN} = 14\text{ V}$, $I_O = 0\text{ A}$		100		mA
Output Characteristics					
V_{OUT} Output voltage	Output current = 10 A		1.0		V
I_{OUT} Output load current	I_{OUT_min} to I_{OUT_max}	0		30	A
Output voltage regulation	Line regulation: Input voltage = 8 V to 14 V		0.5%		
	Load regulation: Output current = 0 A to I_{OUT_max}		0.5%		
V_{OUT} Output voltage ripple	$V_{IN} = 12\text{ V}$, $I_{OUT} = 20\text{ A}$		30		mVpp
V_{OUT} Output overcurrent		20			A
Systems Characteristics					
Switching frequency	F_{SW}		500		kHz
V_{OUT} Peak efficiency	$V_{IN} = 8\text{ V}$, $I_O = 10\text{ A}$, $F_{SW} = 300\text{ kHz}$		92%		
V_{OUT} Full-load efficiency	$V_{IN} = 8\text{ V}$, $I_O = 10\text{ A}$, $F_{SW} = 300\text{ kHz}$		90%		
Operating temperature	T_{oper}			105	°C

3 Schematic

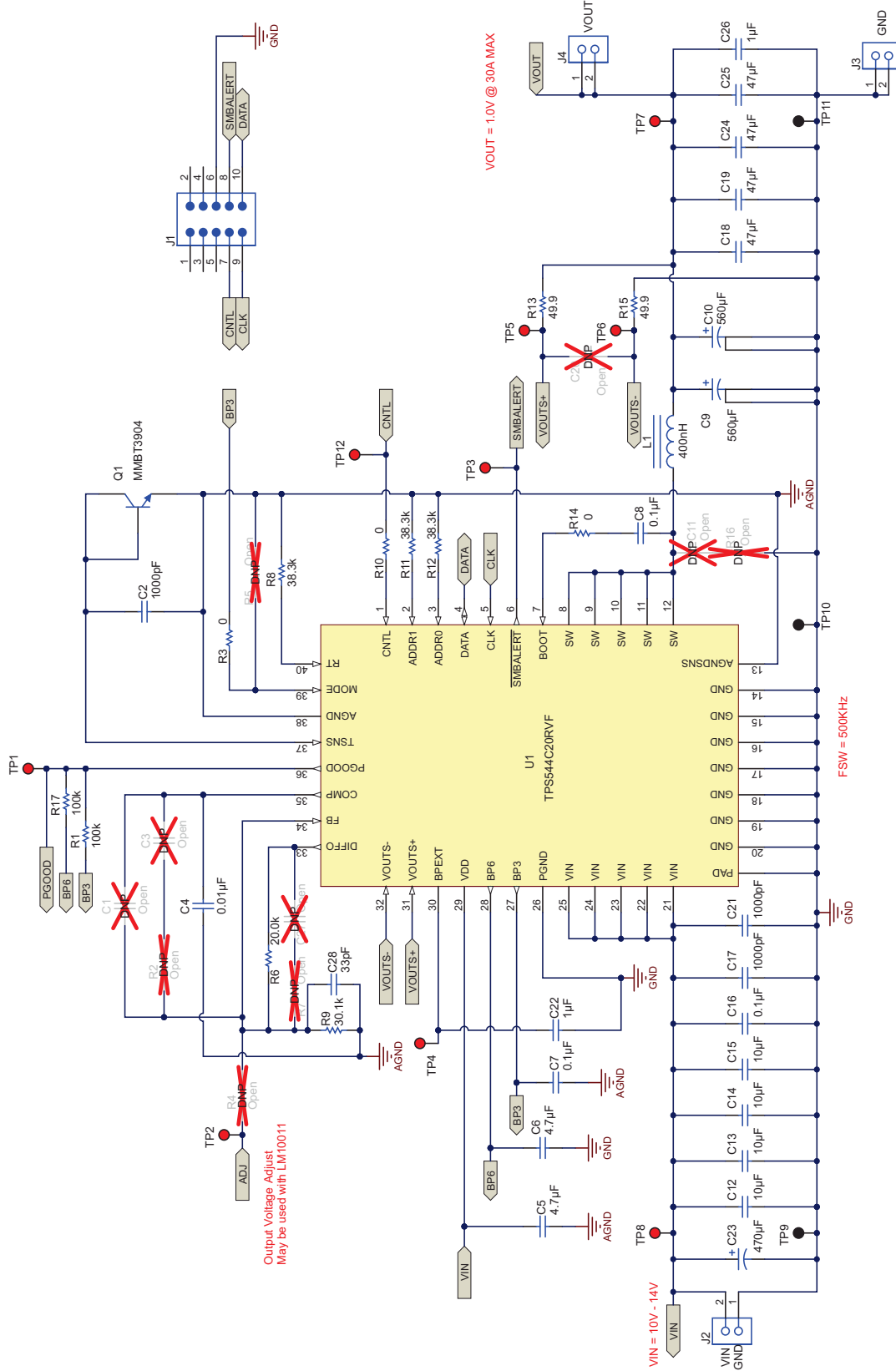

Figure 3-1. PWR-634EVM Schematic

4 Test Setup

4.1 Test and Configuration Software

To change any of the default configuration parameters on the EVM, it is necessary to obtain the TI Fusion Digital Power Designer software. This can be downloaded from the TI website.

4.1.1 Description

The Fusion Digital Power Designer is the graphical user interface (GUI) used to configure and monitor the Texas Instruments TPS544B20 or TPS544C20 power converter installed on this evaluation module. The application uses the PMBus protocol to communicate with the controller over serial bus by way of a TI USB adapter (see [Figure 4-2](#)).

4.1.2 Features

Some of the tasks you can perform with the GUI include:

- Turn on or off the power supply output, either through the hardware control line or the PMBus operation command.
- Monitor real-time data. Items such as input voltage, output voltage, output current, temperature, and warnings and faults are continuously monitored and displayed by the GUI.
- Configure common operating characteristics such as VOUT trim and margin, UVLO, soft-start time, warning and fault thresholds, fault response, and ON/OFF.

This software is available for download at http://www.ti.com/tool/fusion_digital_power_designer

4.2 Test Equipment

Voltage Source: The input voltage source VIN must be a 0-V to 14-V variable dc source capable of supplying at least 5 Adc. Connect VIN to J2 [Figure 4-1](#).

Multimeters: It is recommended to use two separate multimeters [Figure 4-1](#). One meter is used to measure Vin and one to measure Vout.

Output Load: A variable electronic load is recommended for testing [Figure 4-1](#). It must be capable of 30 A at voltages as low as 0.9 V.

Oscilloscope: An oscilloscope is recommended for measuring output noise and ripple. Output ripple must be measured using a Tip-and-Barrel method or better as shown in [Figure 4-3](#). The scope must be adjusted to 20-MHz bandwidth, ac coupling at 50 mV/division, and must be set to 1- μ s/division.

Fan: During prolonged operation at high loads, it may be necessary to provide forced air cooling with a small fan aimed at the EVM. Temperature of the devices on the EVM must be maintained below 105°C.

USB-to-GPIO Interface Adapter: A communications adapter is required between the EVM and the host computer. This EVM was designed to use the Texas Instruments USB-to-GPIO Adapter (see [Figure 4-2](#)). This adapter can be purchased at <http://www.ti.com/tool/usb-to-gpio>.

Recommended Wire Gauge: The voltage drop in the load wires must be kept as low as possible in order to keep the working voltage at the load within its operating range. See the following table for recommended wire gauge and length to achieve a voltage drop of no more than 0.2 V at the maximum 30-A load.

AWG GAUGE	Ω PER FOOT (Ω)	LOAD WIRES COMBINED LENGTH (Ft)	EACH WIRE LENGTH (Ft)
12	1.59E-3	6.30	3.15
14	2.53E-3	3.96	1.98
16	4.02E-3	2.49	1.25
18	6.39E-3	1.57	0.78

As an example, if AWG 12 wire is used, no more than 3.15 feet of wire must be used between the EVM and the load.

4.3 The PWR-634EVM

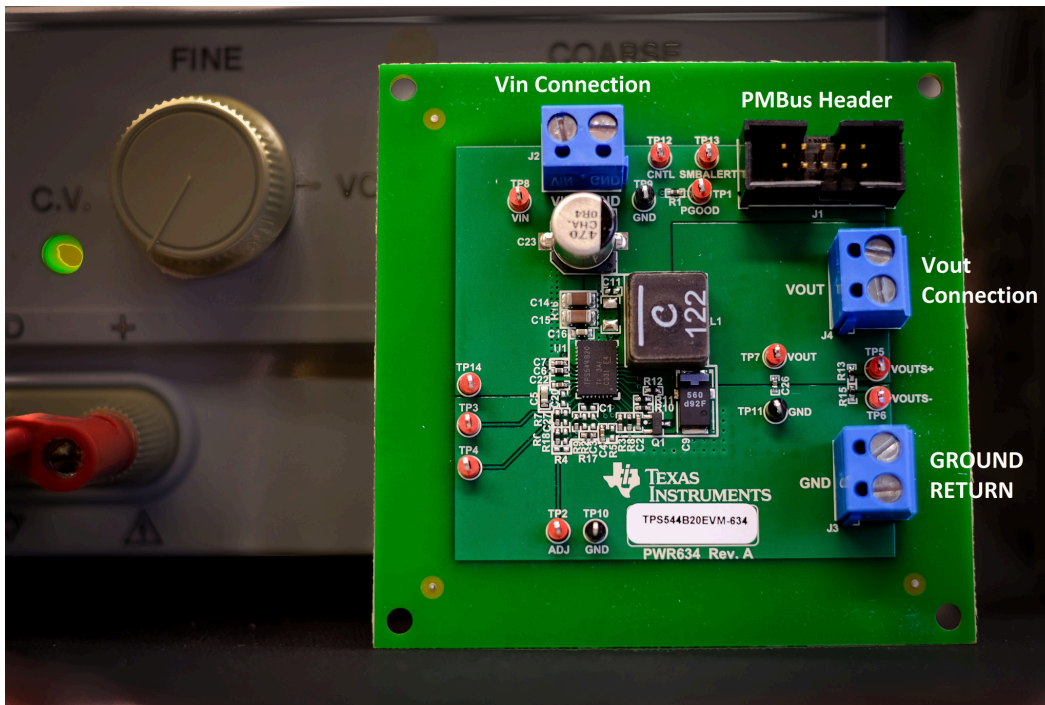

Figure 4-1. PWR-634EVM Overview

4.4 Test Set up and USB Interface Adapter

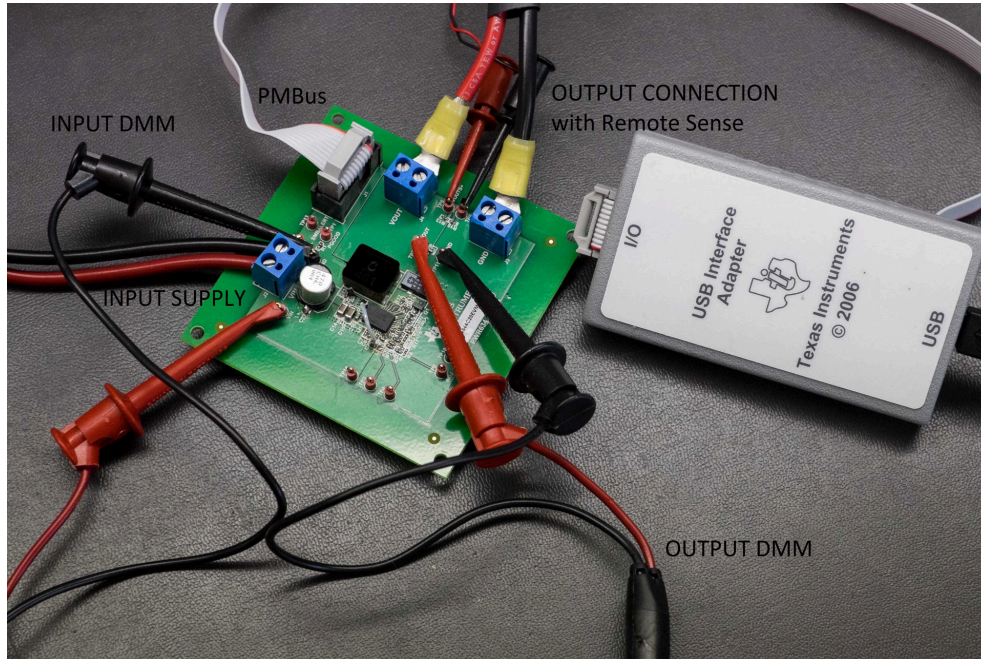
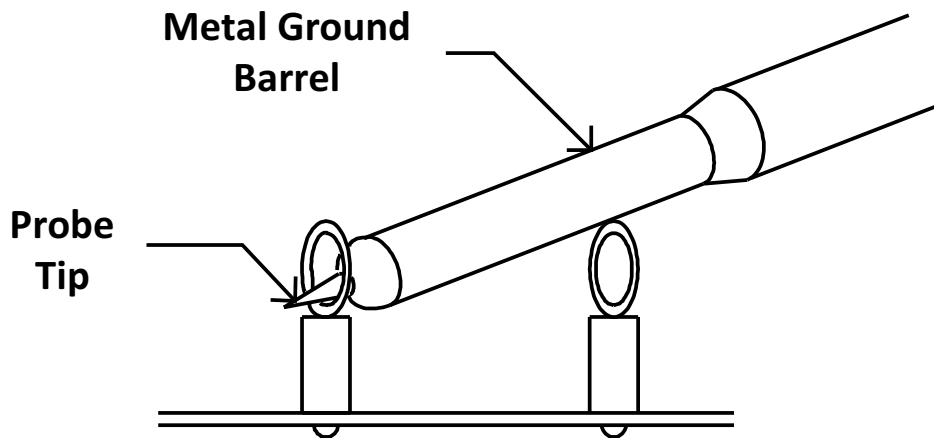

Figure 4-2. Complete Test Setup Including Texas Instruments USB-to-GPIO Adapter



Tip and Barrel V_{OUT} Ripple Measurement

Figure 4-3. Tip and Barrel Measurement

4.5 List of Test Points

Table 4-1. The Function of Each Test Point

TEST POINT	TYPE	NAME	DESCRIPTION
TP1	T-H loop	PGOOD	Power good signal for V_{OUT} .
TP2	T-H loop	ADJ	Output voltage adjust
TP3	T-H loop	SMBALERT	SMB alert signal
TP4	T-H loop	BPEXT	Bypass connect
TP5	T-H loop	$V_{OUT} + \text{Sense}$	
TP6	T-H loop	$V_{OUT} - \text{Sense}$	
TP7	T-H loop	V_{OUT}^+	
TP8	T-H loop	V_{IN}^+	
TP9	T-H loop	V_{IN}^-	
TP10	T-H loop	GND	
TP11	T-H loop	V_{OUT}^-	
TP12	T-H loop	CNTL	Control signal

5 EVM Configuration Using the Fusion GUI

The TPS544B20 or TPS544C20 installed on this EVM leave the factory pre-configured. See [Table 5-1](#) for a short list of key factory configuration parameters as obtained from the configuration file.

Table 5-1. Key Factory Configuration Parameters

ADDRESS HEX	ADDRESS DEC	PART ID			
0x1B	27	TPS544x20			
GENERAL					
CMD ID WITH PHASE	CMD CODE HEX	ENCODED HEX	DECODED	NUMERIC	COMMENTS
VIN_OFF	0x36	0xF014	5.00 V	5	Turn OFF voltage
VIN_ON	0x35	0xF01C	7.00 V	7	Turn ON voltage
TPS544B20					
COMMENTS					
IOUT_CAL_GAIN	0x38	0x8821	1.0071 mΩ	1.0071	DCR of output inductor
IOUT_CAL_OFFSET	0x39	0xE000	0.0000 A	0	Current offset for GUI readout
IOUT_OC_FAULT_LIMIT	0x46	0xF83C	30.0 A	30	OC fault level
IOUT_OC_FAULT_RESPONSE	0x47	0x3C	Restart continuously		Response to OC fault
IOUT_OC_WARN_LIMIT	0x4A	0xF832	25.0 A	25	OC warning level
MFR_04 (VREF_TRIM)	0xD4	0x0000	0.000 V	0	Trim voltage
ON_OFF_CONFIG	0x02	0x02	Mode: always converting		Control signal and operation command not required
OPERATION	0x01	0x00	Unit: immediate off; margin: none		Response to turn OFF trigger
OT_FAULT_LIMIT	0x4F	0x007D	125°C	125	OT fault level
OT_WARN_LIMIT	0x51	0x0064	100°C	100	OT warn level
TON_RISE	0x61	0xE02B	2.6875 ms	2.6875	Soft-start time
TPS544C20					
COMMENTS					
IOUT_CAL_GAIN	0x38	0x8821	1.0071 mΩ	1.0071	DCR of output inductor
IOUT_CAL_OFFSET	0x39	0xE000	0.0000 A	0	Current offset for GUI readout
IOUT_OC_FAULT_LIMIT	0x46	0xF832	25.0 A	25	OC fault level
IOUT_OC_FAULT_RESPONSE	0x47	0x3C	Restart continuously		Response to OC fault
IOUT_OC_WARN_LIMIT	0x4A	0xF828	20.0 A	20	OC warning level
MFR_04 (VREF_TRIM)	0xD4	0x0000	0.000 V	0	Trim voltage
ON_OFF_CONFIG	0x02	0x02	Mode: always converting		Control signal and operation command not required
OPERATION	0x01	0x00	Unit: immediate off; margin: none		Response to turn off trigger
OT_FAULT_LIMIT	0x4F	0x007D	125°C	125	OT fault level
OT_WARN_LIMIT	0x51	0x0064	100°C	100	OT warn level
TON_RISE	0x61	0xE02B	2.6875 ms	2.6875	Soft-start time

If it is desired to configure the EVM to settings other than the factory settings shown in [Table 5-1](#), the TI Fusion Digital Power Designer software can be used for reconfiguration. It is necessary to have input voltage applied to the EVM prior to launching the software so that the TPS544B20 or TPS544C20 installed is active and able to respond to the GUI and the GUI can recognize the device. The default configuration for the EVM is to start converting at an input voltage of 4.5 V; therefore, to avoid any converter activity during configuration, an input voltage less than 4.5 V must be applied. An input voltage of 4 V is recommended.

5.1 Configuration Procedure

1. Adjust the input supply to provide 4 V_{DC}, current limited to 1 A.
2. Apply the input voltage to the EVM. See [Figure 4-1](#) and [Figure 4-2](#) for connections and test setup.
3. Launch the Fusion GUI software. See the screen shots in [Section 8](#) for more information.
4. Configure the EVM operating parameters as desired.

6 Test Procedure

6.1 Line/Load Regulation and Efficiency Measurement Procedure

1. Set up the EVM as described in [Section 4.3](#) and [Figure 4-1](#).
2. Ensure that the electronic load is set to draw 0 A_{DC}.
3. Increase V_{IN} from 0 V to 12 V using the DMM to measure input voltage.
4. Use the other DMM to measure output voltage V_{OUT}.
5. Vary the load from 0 A_{DC} to maximum rated output A_{DC} (TPS544B20 = 20 A, TPS544C20 = 30 A). V_{OUT} must remain in regulation as defined in [Table 2-1](#).
6. Vary V_{IN} from 8 V to 14 V. V_{OUT} must remain in regulation as defined in [Table 2-1](#).
7. Decrease the load to 0 A.
8. Decrease V_{IN} to 0 V.

6.2 Efficiency

To measure the efficiency of the power train on the EVM, it is important to measure the voltages at the correct location. This is necessary because otherwise the measurements will include losses in efficiency that are not related to the power train itself. Losses incurred by the voltage drop in the copper traces and in the input and output connectors are not related to the efficiency of the power train, and they must not be included in efficiency measurements.

Table 6-1. List of Test Points for Efficiency Measurements

TEST POINT	NODE NAME	DESCRIPTION
TP8	VIN	Measurement point for VIN +VE
TP9	PGND	Measurement point for VIN –VE
TP7	VOUT	Measurement point for VOUT +VE
TP11	PGND	Measurement point for VOUT –VE

Input current can be measured at any point in the input wires, and output current can be measured anywhere in the output wires of the output being measured. Using these measurement points result in efficiency measurements that do not include losses due to the connectors and PCB traces.

6.3 Equipment Shutdown

1. Reduce the load current on both outputs to 0 A.
2. Reduce input voltage to 0 V.
3. Shut down the external fan if in use.
4. Shut down equipment.

7 Performance Data and Typical Characteristic Curves

Figure 7-1 through Figure 7-9 present typical performance curves for the PWR-634EVM.

7.1 Efficiency

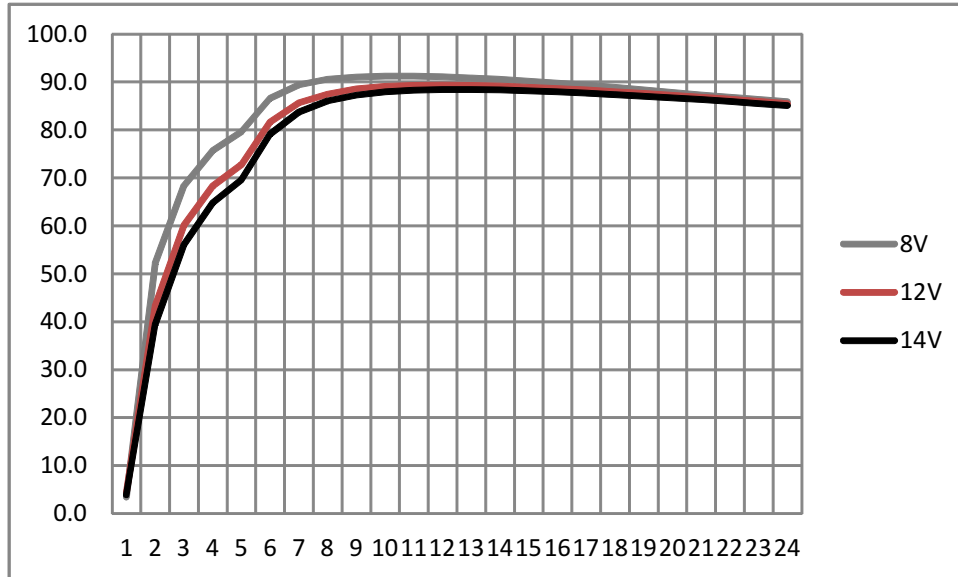

Figure 7-1. Efficiency of 1-V Output vs Line and Load

7.2 Load Regulation

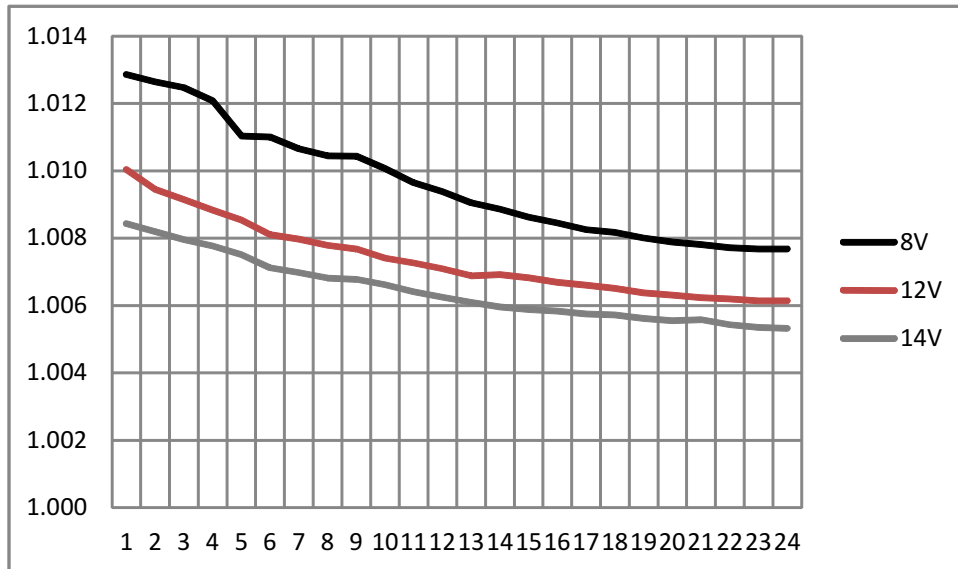
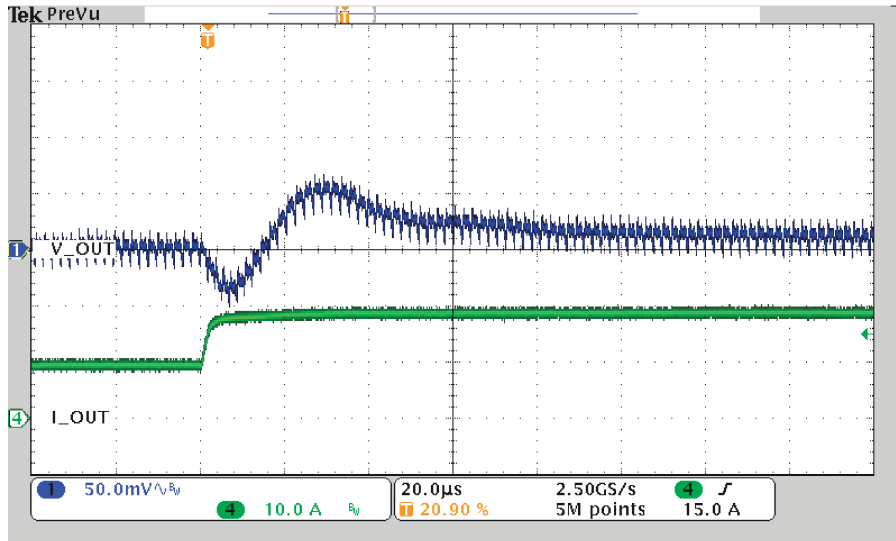

Figure 7-2. Load Regulation of 1-V Output

7.3 Transient Response



Load Step 10A to 20A

Ch1 = VOUT1 at 50-mV/division, Ch2 = IOUT1 at 5-A/division

Figure 7-3. Transient Response of 1-V Output at 12 V_{IN}, Transient is 10 A to 20 A

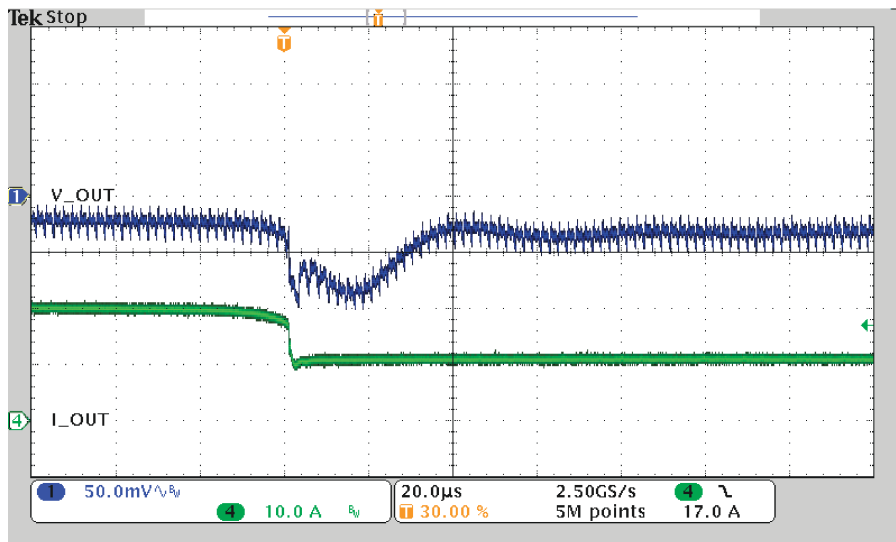

Load Release 20A to 10A

Ch1 = VOUT1 at 50-mV/division, Ch2 = IOUT1 at 5-A/division

Figure 7-4. Transient Response of 1-V Output at 12 V_{IN}, Transient is 20 A to 10 A

7.4 Output Ripple

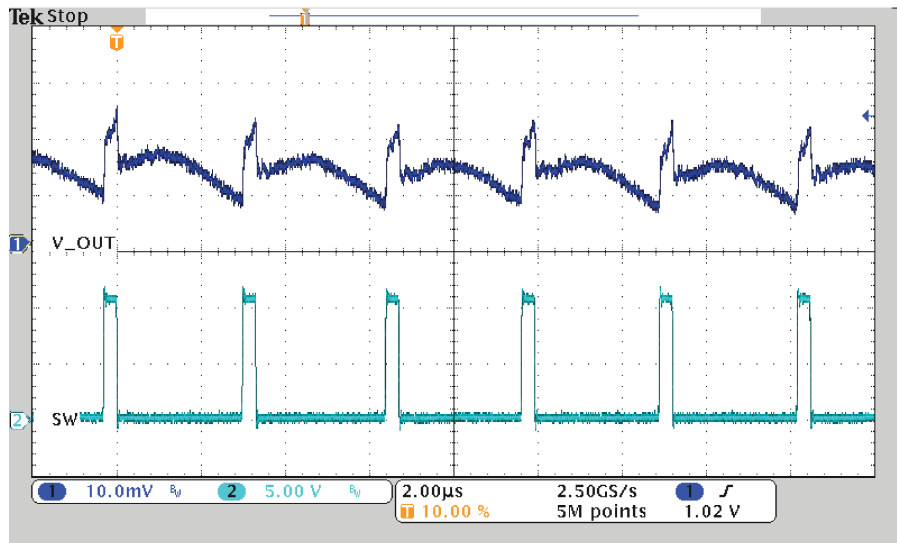

DC Ripple 1A Load

Ch1 = VOUT1 at 20-mV/division, Ch2 = SW Node at 10-V/division

Figure 7-5. Output Ripple and SW Node of 1-V Output at 12 V_{IN}, 1-A Output

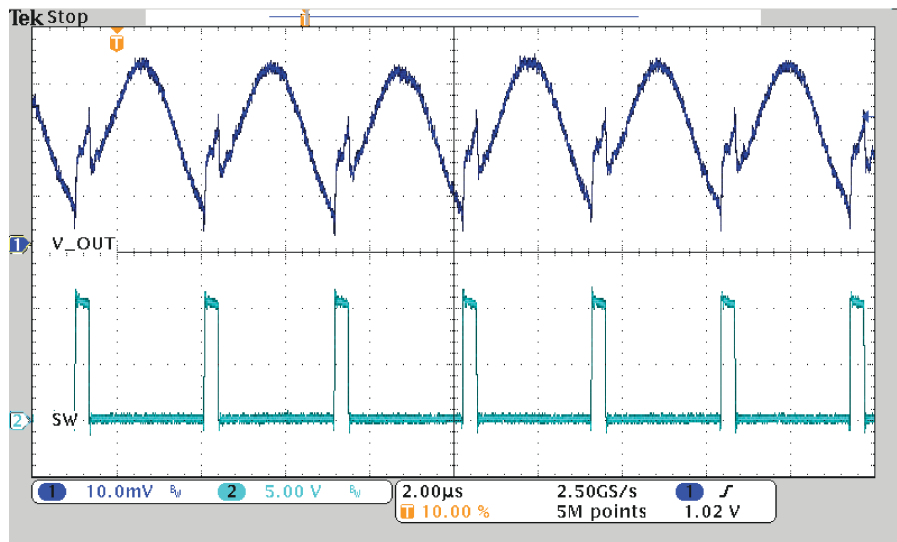

DC Ripple 20A Load

Ch1 = VOUT1 at 20-mV/division, Ch2 = SW Node at 10-V/division

Figure 7-6. Output Ripple and SW Node of 1-V Output at 12 V_{IN}, 20-A Output

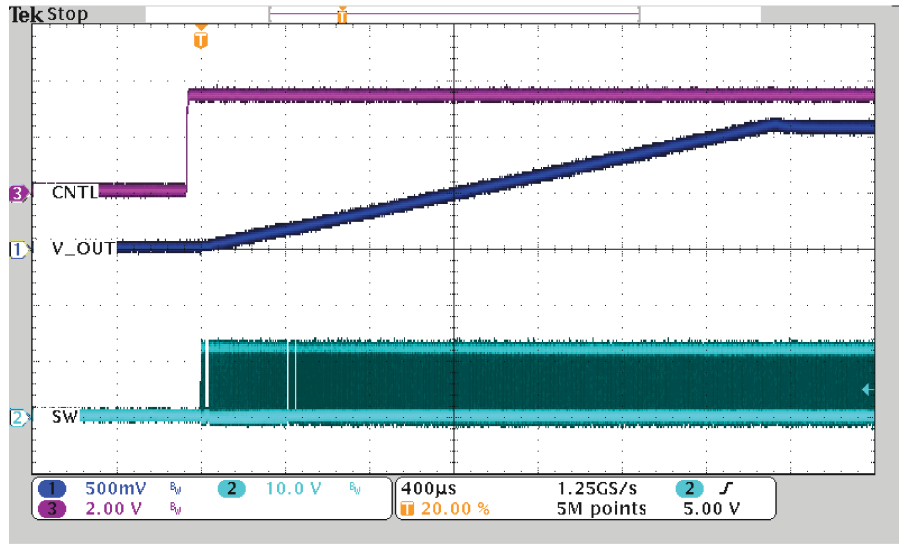

StartUp from CNTL into 20A

Ch1 = VOUT2 at 20-mV/division, Ch2 = SW Node at 10-V/division

Figure 7-7. Start up from Control 1-V Output at 12 V_{IN}, 20-A Output

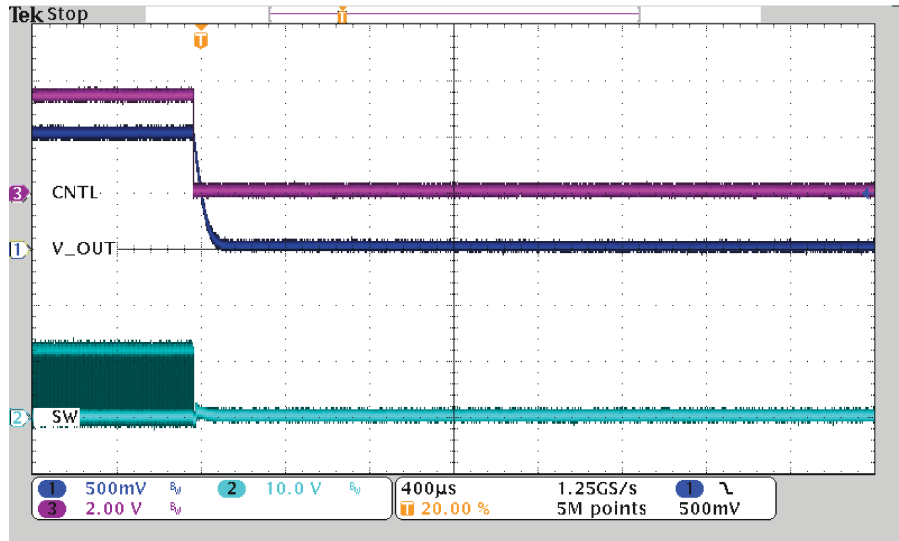

ShutDown from CNTL

Ch1 = VOUT2 at 20-mV/division, Ch2 = SW Node at 10-V/division

Figure 7-8. Shutdown from Control and SW Node of 1-V Output at 12 V_{IN}, 20-A Output

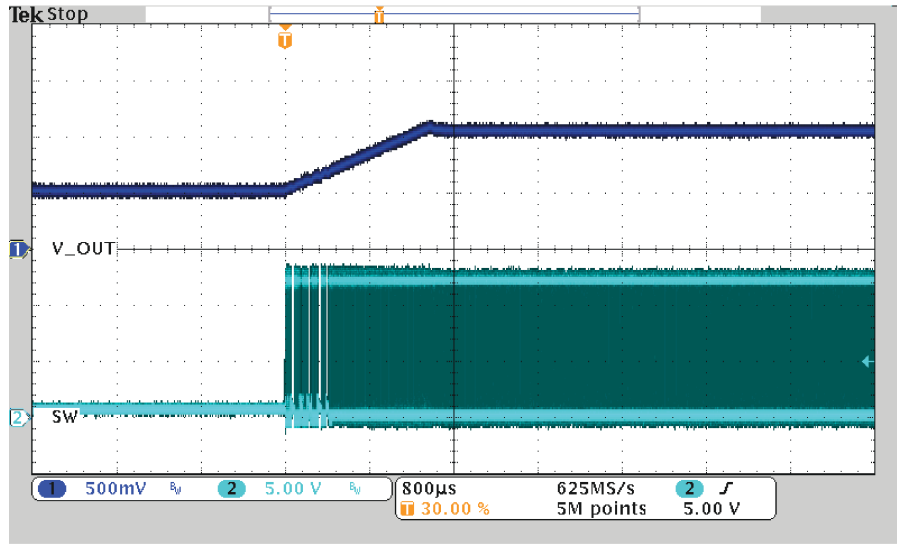

50% PreBias Start No Load

Figure 7-9. 50% PreBias Start (No Load)

8 Screen Shots

8.1 Fusion GUI Screen Shots

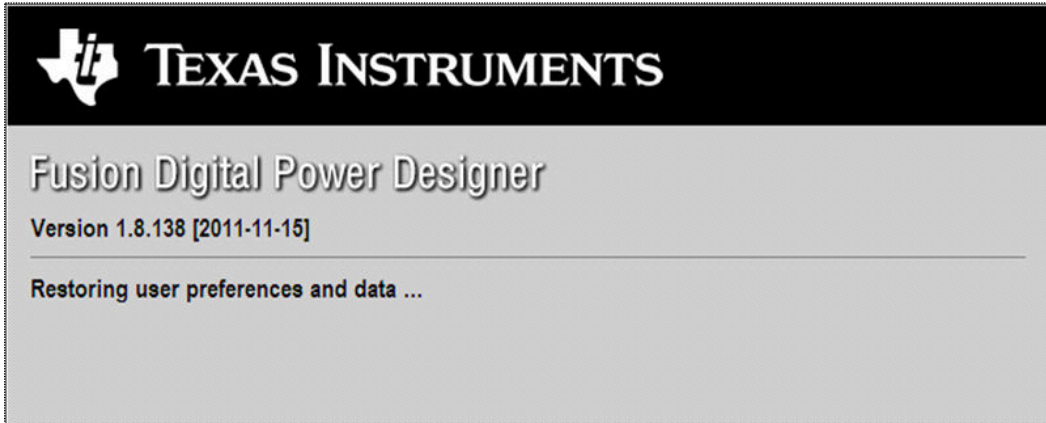

Figure 8-1. First Window at Fusion Launch



Figure 8-2. Scan Finds Device Successfully



Figure 8-3. Software Launch Continued

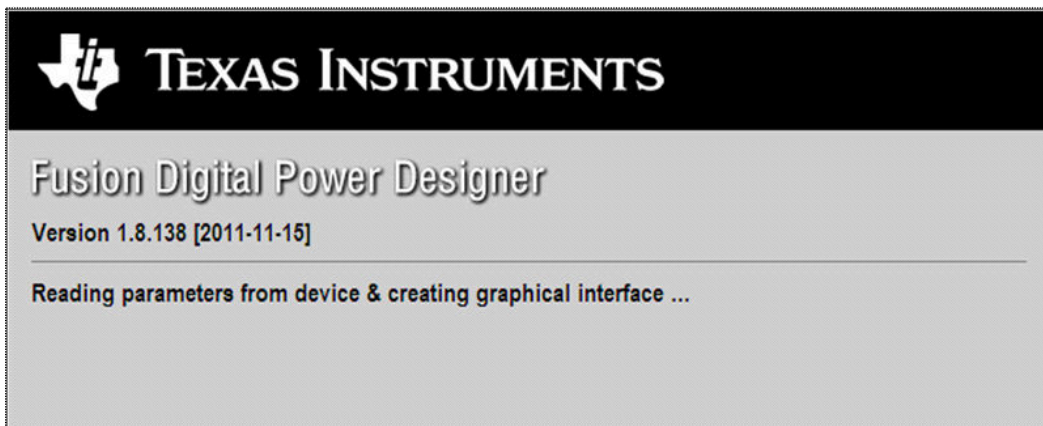

Figure 8-4. Software Launch Continued

Use this next screen to configure the following (Figure 8-5):

- OC fault and OC warn
- OT fault and OT warn
- Power good limits
- Fault response
- UVLO
- On/Off configuration
- Soft-start time
- Margin voltage

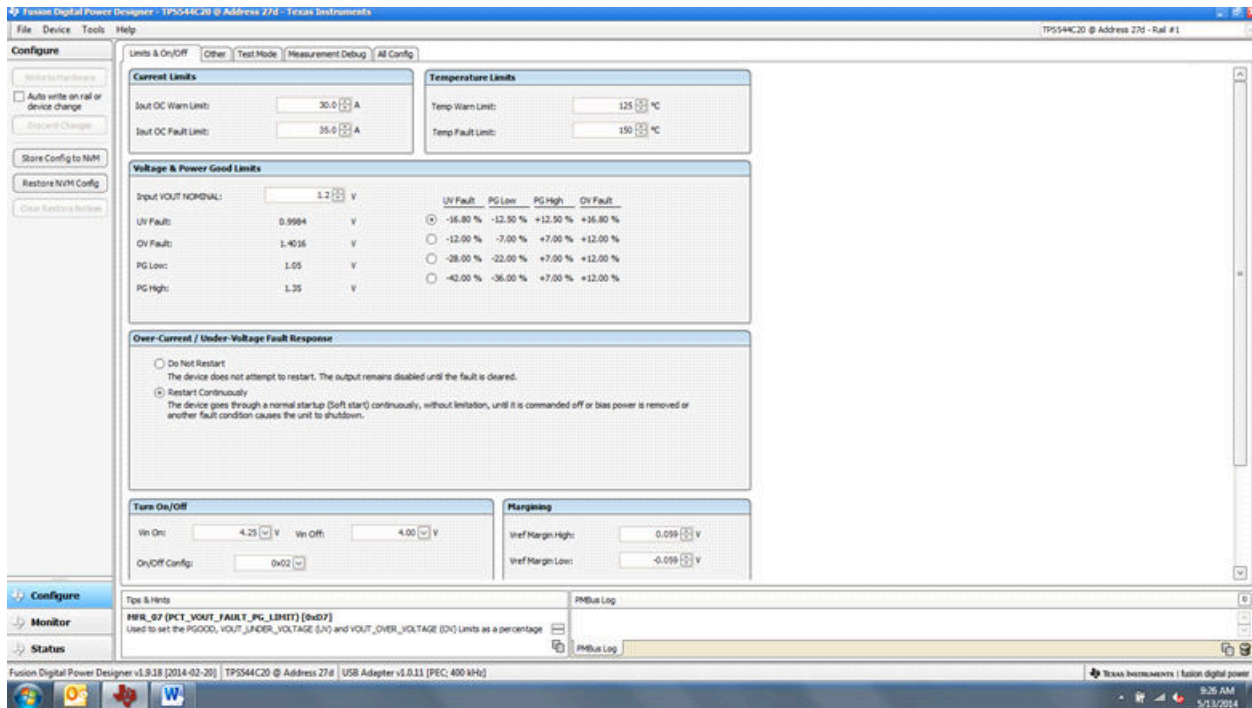

Figure 8-5. First Screen After Successful Launch: Configure- Limits & On/Off

Use this screen to configure the following (Figure 8-6) :

- V_{REF} trim
- I_{OUT} cal gain (DCR of output choke)

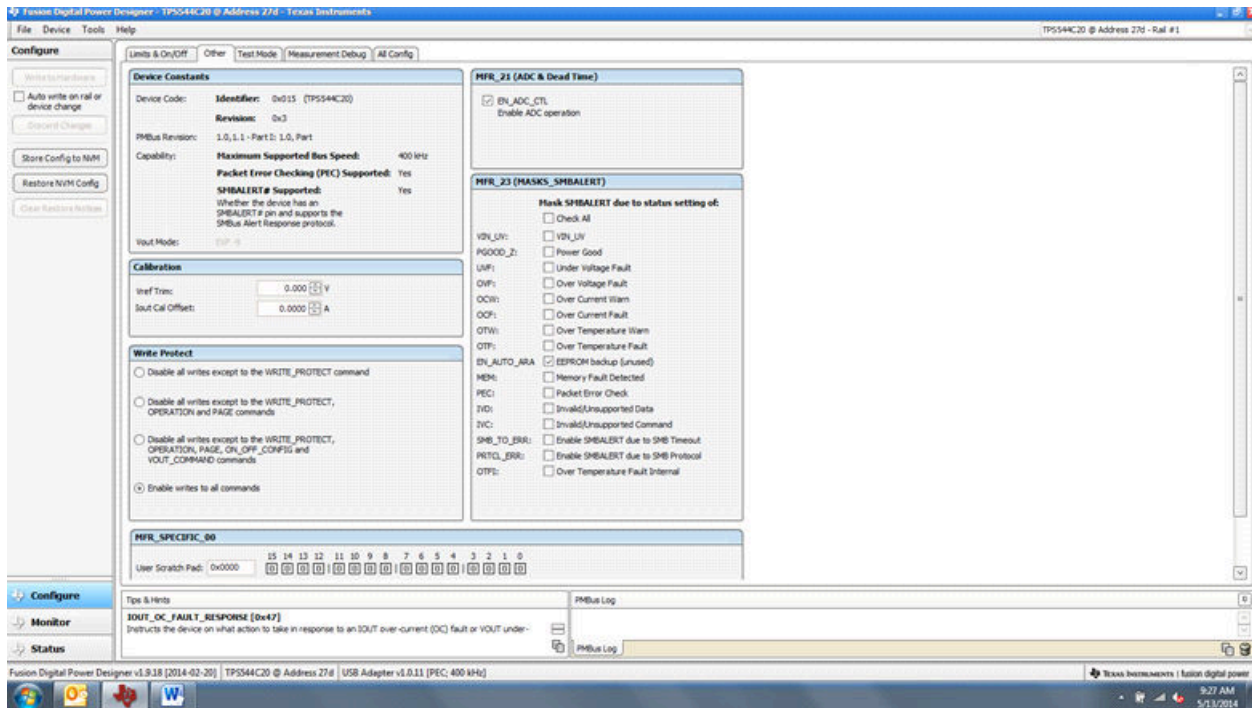

Figure 8-6. Configure – Other

Use this screen to configure all of the configurable parameters (Figure 8-7). The screen also shows other details, like hexadecimal (hex) encoding.

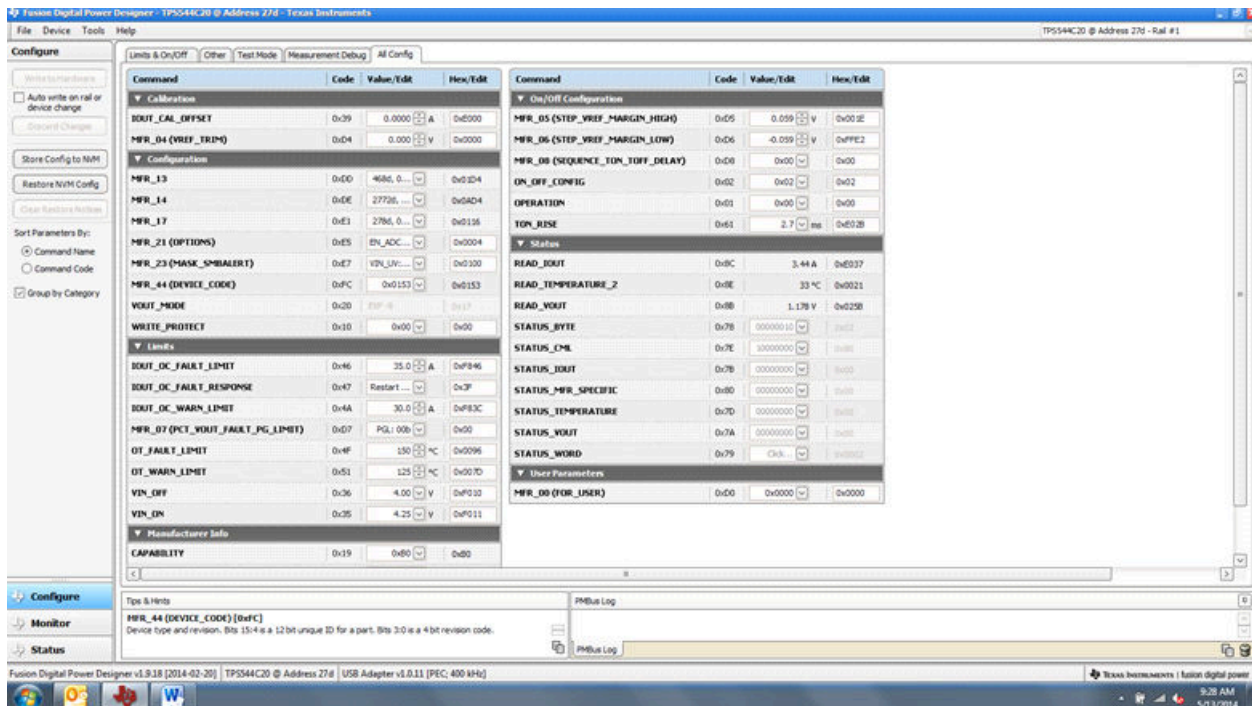

Figure 8-7. Configure – All

Changing the on/off configuration prompts a pop-up window with details of the options (Figure 8-8).

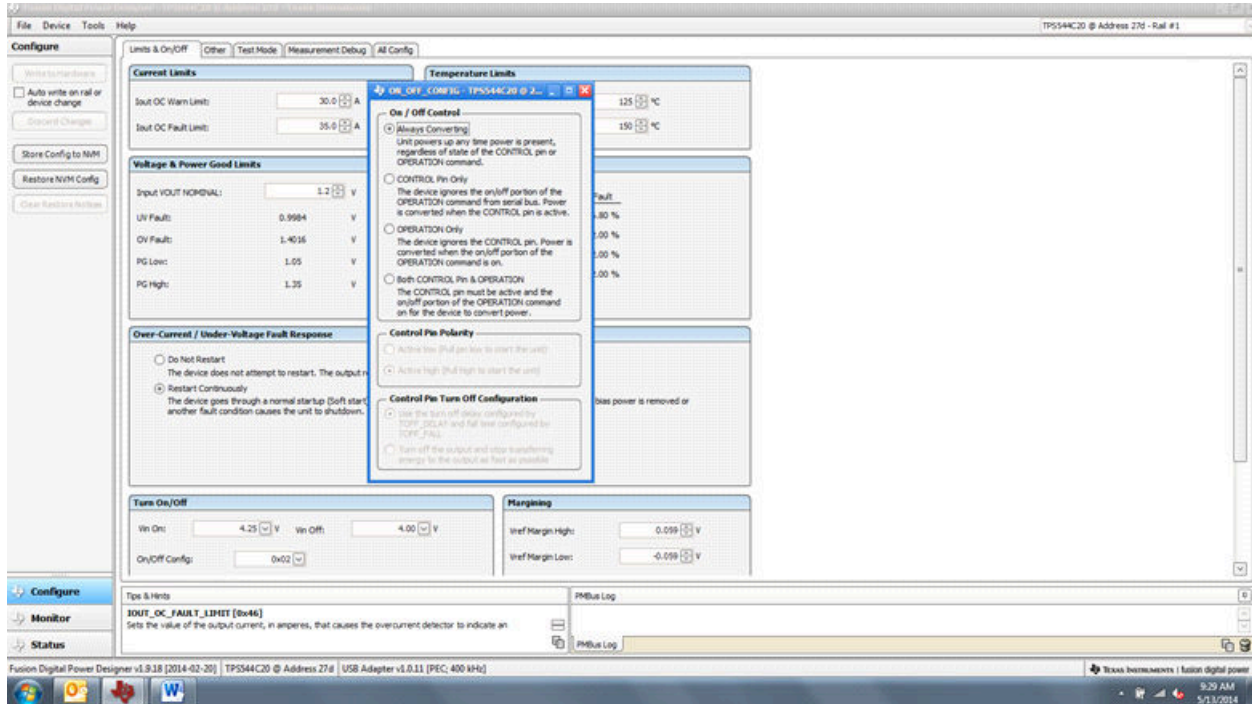

Figure 8-8. Configure- Limits and On/Off- On/Off Configuration Pop-up

After a change is selected, an orange **U** icon is displayed to offer the *Undo Change* option. The change is not retained until either *Write to Hardware* or *Store User Defaults* is selected. When *Write to Hardware* is selected, the change is committed to volatile memory and defaults back to the previous setting on the input power cycle. When *Store User Defaults* is selected, the change is committed to the nonvolatile memory and becomes the new default (Figure 8-9).

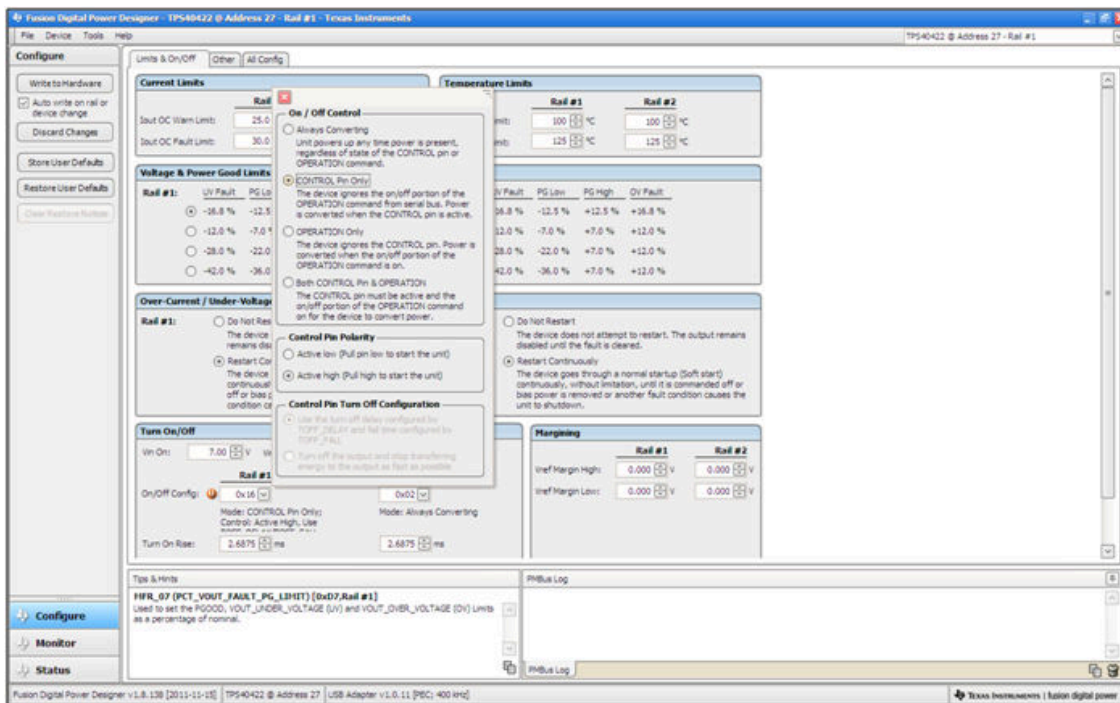

Figure 8-9. Configure- Limits and On/Off- On/Off Config Pop-up

The I_{OUT} cal gain can be typed in or scrolled to a new value. The range for I_{OUT} cal gain is 0.244 mΩ to 15.5 mΩ and the resolution step is 30.5 μΩ. If a value is typed in that is between the available discrete steps, the typed-in value does not change but the nearest discrete step is retained. The actual step is displayed on relaunch of the Fusion GUI (Figure 8-10).

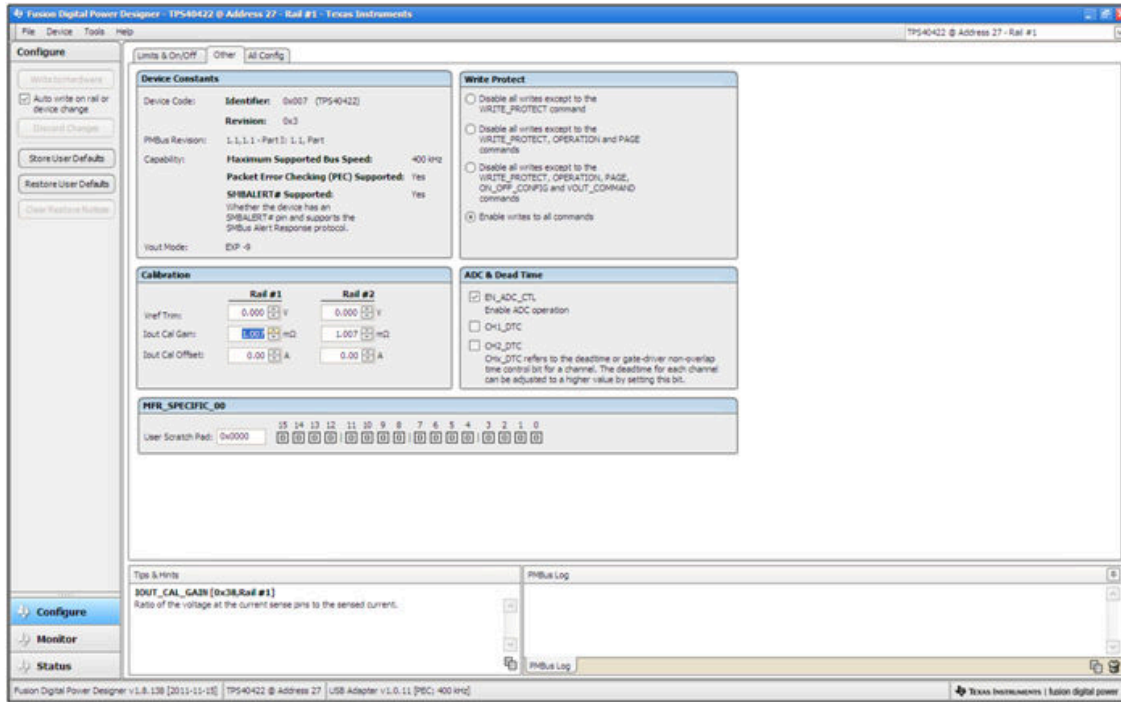

Figure 8-10. Configure- Other- I_{OUT} Cal Gain Change

The On/Off configuration can also be configured from the All configuration screens, where the same process applies (Figure 8-11).

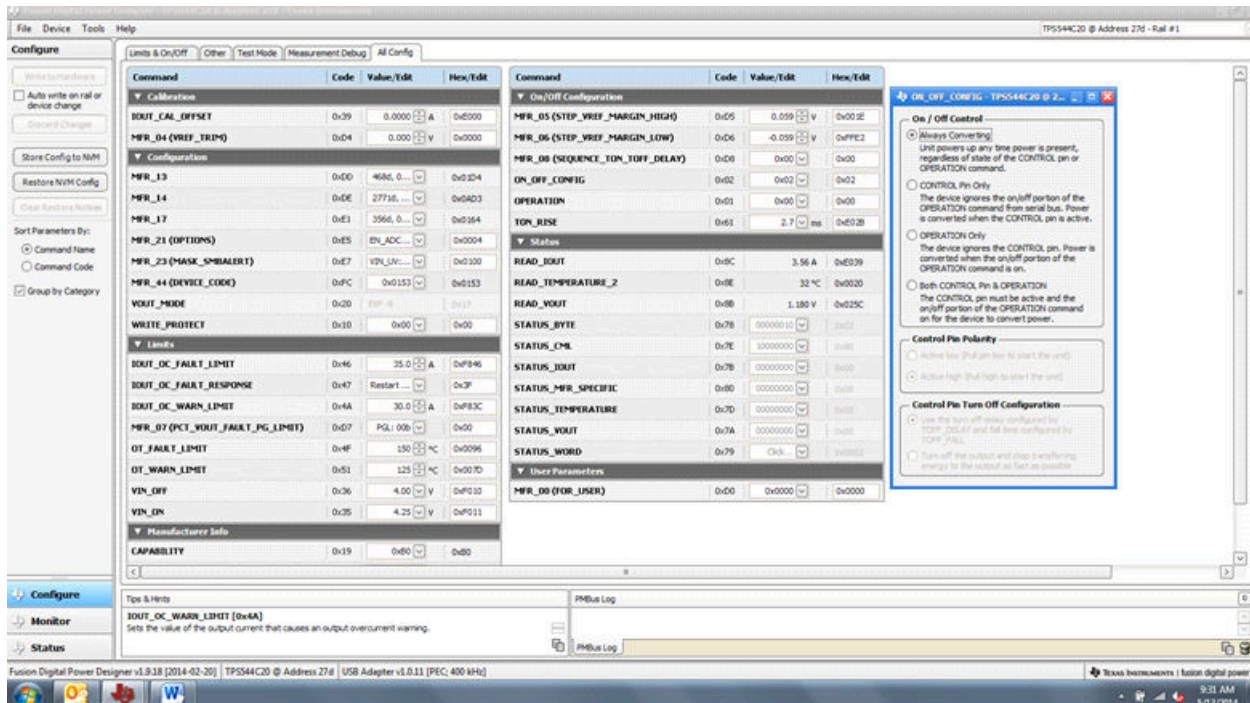

Figure 8-11. Configure- All Config- On/Off Config Pop-up

After making changes to one or more configurable parameters, the changes can be committed to nonvolatile memory by selecting *Store User Defaults*. This action prompts a *confirm selection* pop-up, and if confirmed, the changes are committed to nonvolatile memory (Figure 8-12).

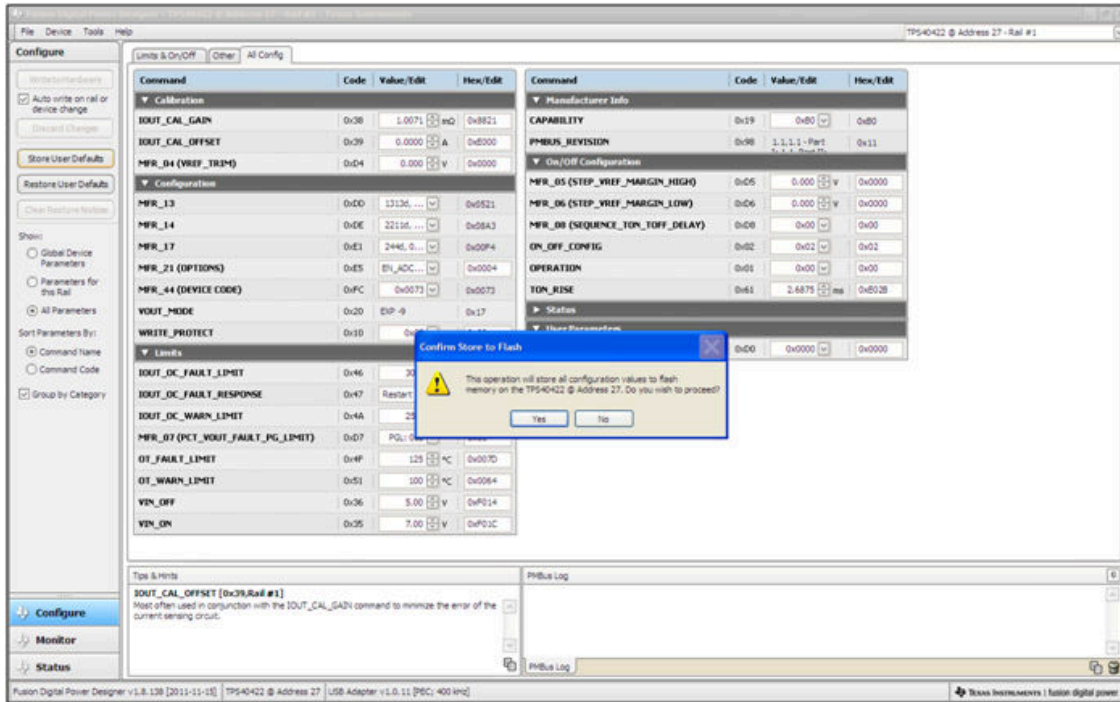

Figure 8-12. Configure- Store User Defaults

In the lower left corner, the different view screens can be changed. The view screens can be changed between *Configure*, *Monitor* and *Status* as needed (Figure 8-13).

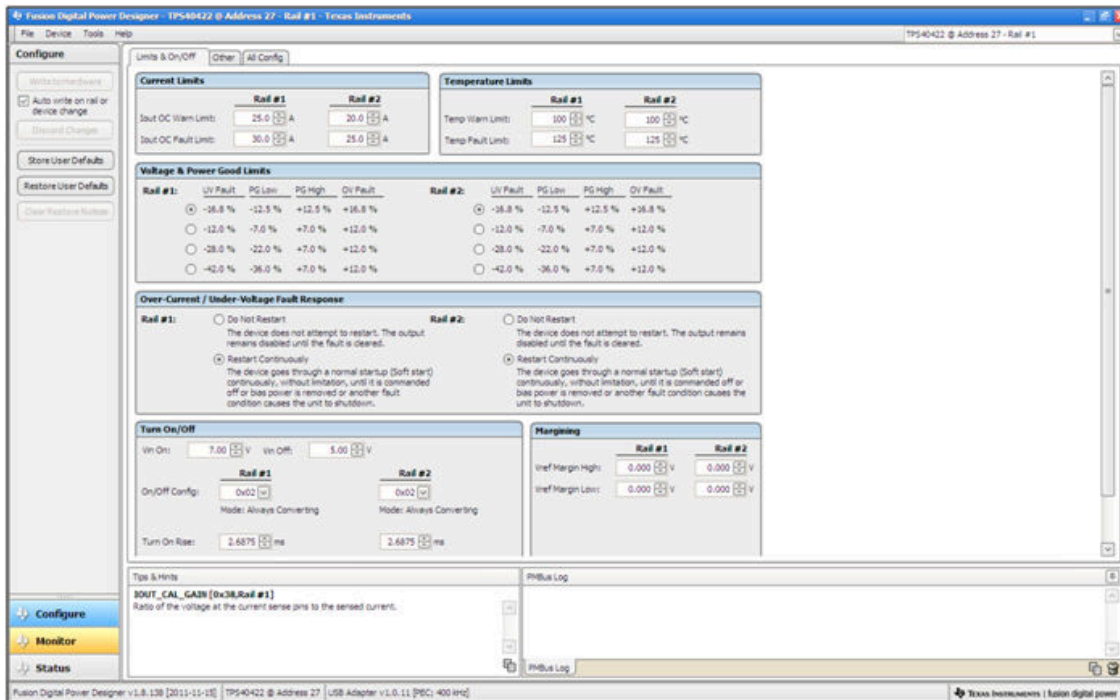

Figure 8-13. Change View Screen to Monitor Screen

When the *Monitor* screen is selected (Figure 8-14), the screen changes to display real-time data of the parameters that are measured by the controller. This screen provides access to:

- Graphs of V_{OUT} , I_{OUT} , *Temperature*, and P_{OUT} . As shown, P_{OUT} display is turned off.
- *Start/Stop polling* which turns on or off the real-time display of data.
- Quick access to on/off configuration
- Control pin activation, and operation command. As shown, because the device is configured for *always converting*, these radio buttons are either grayed-out or have no effect.
- Margin control
- PMBus log, which displays activity on the PMBus
- *Tips and hints*, which displays additional information when the cursor is hovered over configurable parameters.

At first GUI launch, faults can occur due to communications during power up. These faults can be cleared once the device is enabled.

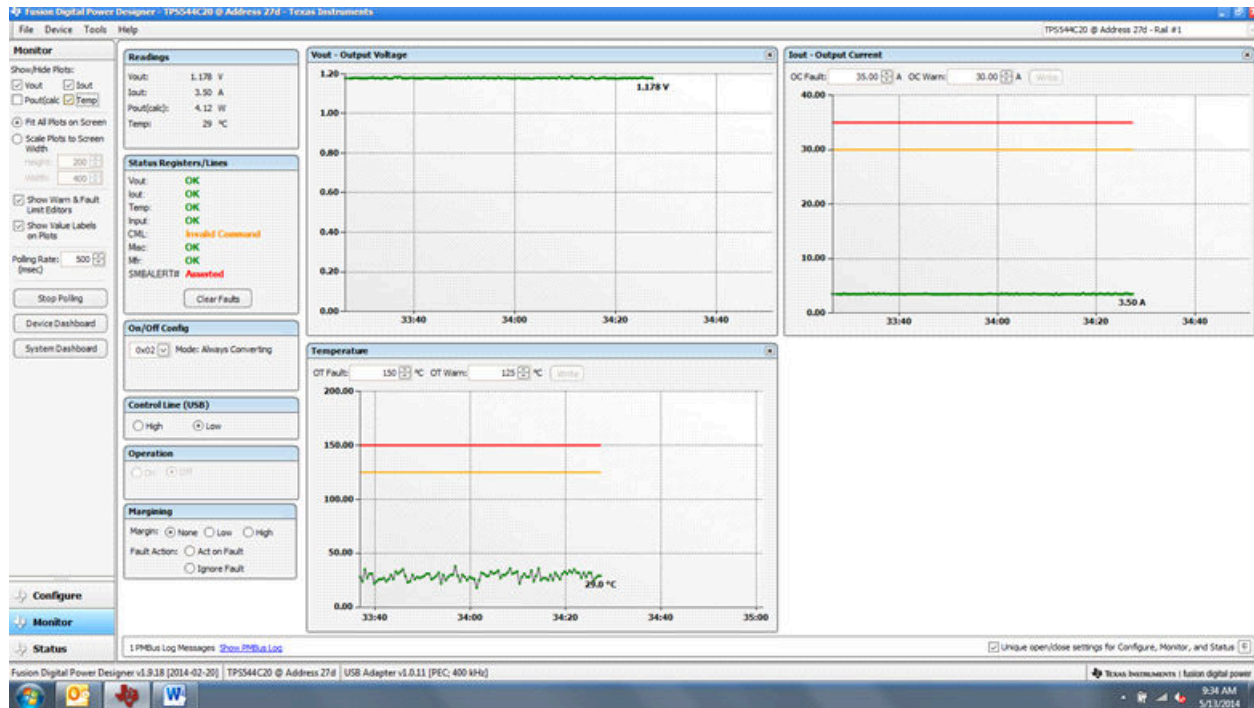

Figure 8-14. Monitor Screen

Selecting *System Dashboard* from the mid-left screen adds a new window which displays system-level information (Figure 8-15).

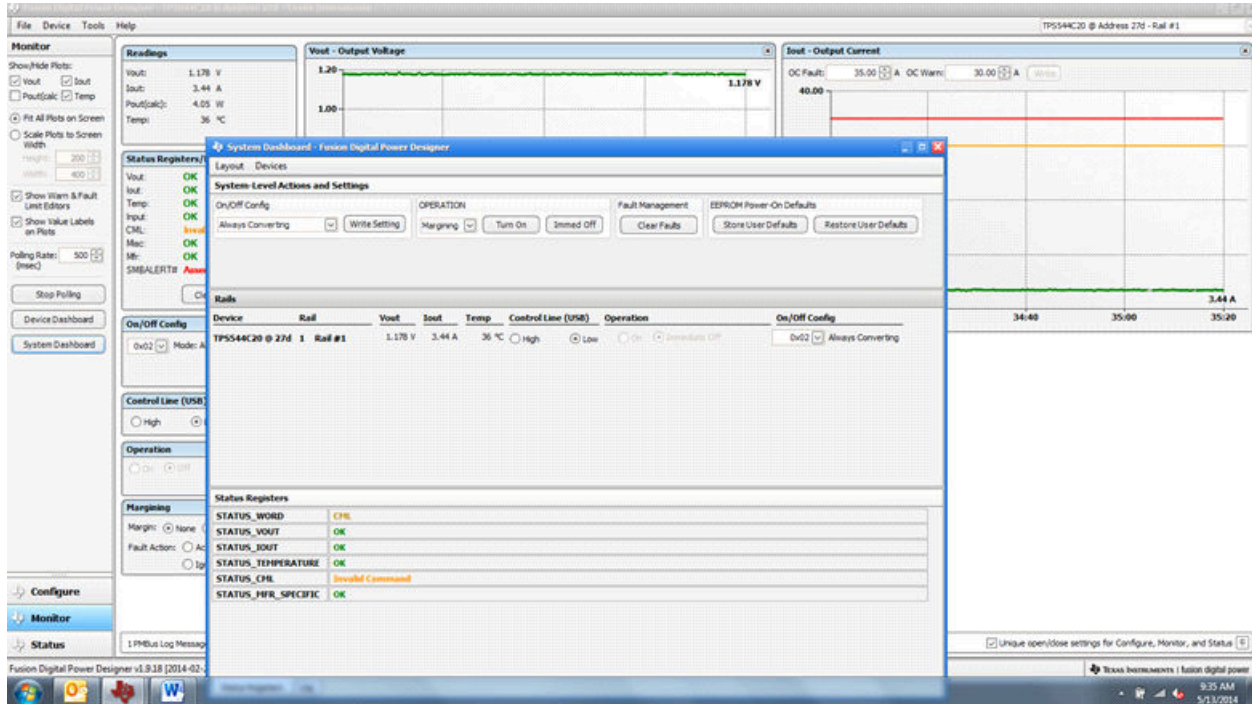

Figure 8-15. System Dashboard

When the EVM starts converting power, the V_{OUT} graph changes scale to display both the zero and V_{OUT} level. Once the EVM is converting and clear of any faults, selecting *Clear Faults* clears any prior fault flags (Figure 8-16).



Figure 8-16. Display Change on Power Up

Screen Shots

Selecting *Clear Faults* clears any prior fault flags. Scrolling time window of V_{OUT} will still show any turn-on event (Figure 8-17).



Figure 8-17. Faults Cleared

Selecting *Status* from lower left corner shows the status of the controller (Figure 8-18).

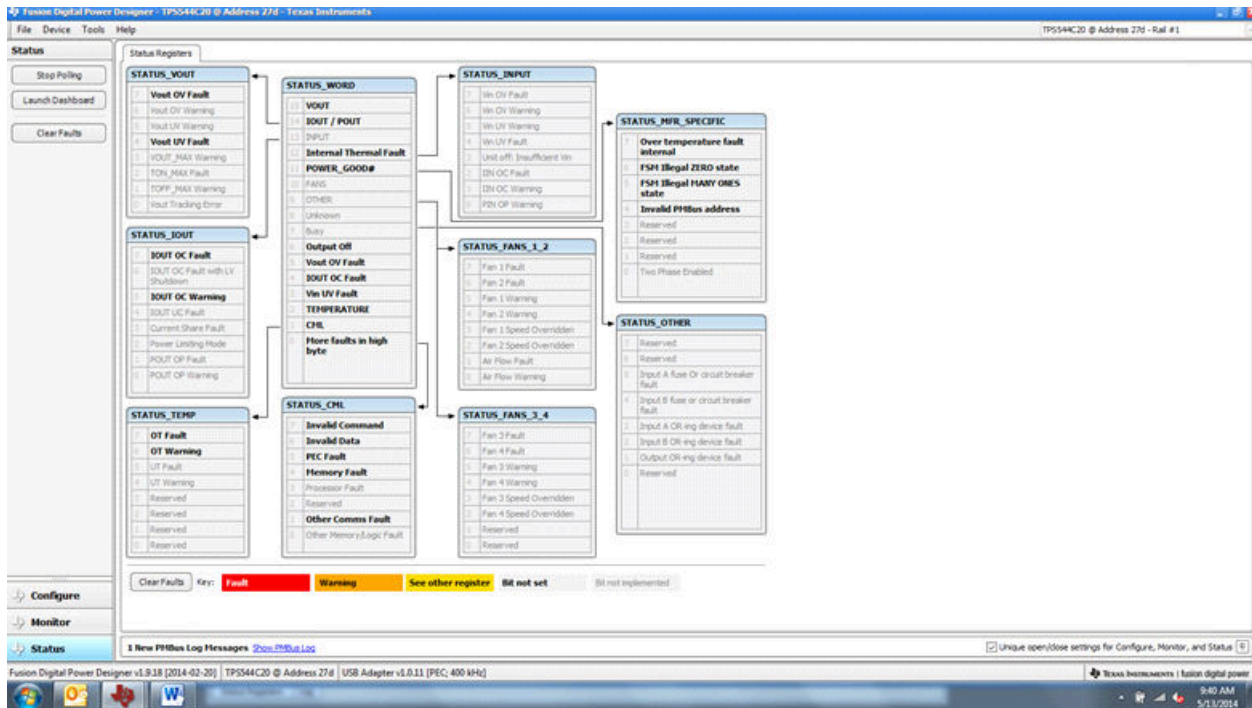

Figure 8-18. Status Screen

Selecting the pulldown menu *File- Import Project* from the upper left menu bar can be used to configure all parameters in the device at once with a desired configuration, or even revert back to a *known-good* configuration. This action results in a browse-type sequence where the desired configuration file can be located and loaded (Figure 8-19).



Figure 8-19. Import Project / Import Configuration File

Selecting *Store User Configuration to Flash Memory* from the device pulldown menu has the same functionality as the *Store User Defaults* button from within the configure screen. It results in committing the current configuration to nonvolatile memory (Figure 8-20).



Figure 8-20. Store Configuration To Memory

Select **Data Logging** (Figure 8-21), from the Tools drop-down menu. This enables logging of common operating values such as V_{OUT} , I_{OUT} , and temperature. The user is prompted to select a location for the file to be stored as well as the type of file. Select the storage location for the file and the type of file. The file will be a CSV file to be stored in the directory path shown. Logging begins when the **Start Data Logging** button is selected, and stops when it is reselected.

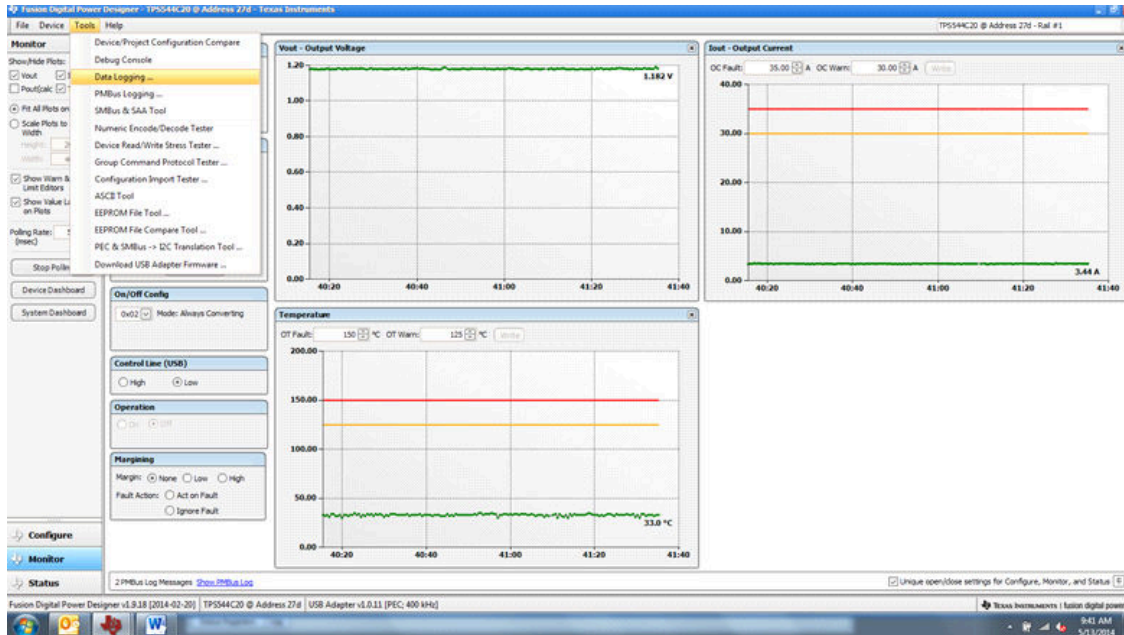

Figure 8-21. Data Logging Details

Common contents of the data log as shown in (Figure 8-22). The UUT had was running with a modified voltage, at an approximate 3.5-A load and room temperature.

A	B	C	D	E	F	G	H	I	J	K	L	M	N	O	P	Q	R	S	T	U	V	
1	Timestamp	Adapter	Part_ID	Address	READ_VOUT	READ_IOUT	READ_TEMPERATURE_2															
2	45:28.3	1	TP5544C20	27	1.178	3.5	32															
3	45:28.8	1	TP5544C20	27	1.184	3.4375	33															
4	45:29.3	1	TP5544C20	27	1.18	3.4375	35															
5	45:29.8	1	TP5544C20	27	1.178	3.4375	33															
6	45:30.3	1	TP5544C20	27	1.18	3.4375	33															
7	45:30.8	1	TP5544C20	27	1.18	3.4375	31															
8	45:31.3	1	TP5544C20	27	1.182	3.5	33															
9	45:31.8	1	TP5544C20	27	1.178	3.4375	32															
10	45:32.3	1	TP5544C20	27	1.178	3.4375	33															
11	45:32.8	1	TP5544C20	27	1.18	3.4375	33															
12	45:33.3	1	TP5544C20	27	1.182	3.4375	33															
13	45:33.8	1	TP5544C20	27	1.18	3.4375	33															
14	45:34.3	1	TP5544C20	27	1.18	3.4375	38															
15	45:34.8	1	TP5544C20	27	1.184	3.4375	33															
16	45:35.3	1	TP5544C20	27	1.182	3.4375	34															
17	45:35.8	1	TP5544C20	27	1.186	3.4375	32															
18	45:36.3	1	TP5544C20	27	1.182	3.5	37															
19	45:36.8	1	TP5544C20	27	1.182	3.4375	32															
20	45:37.3	1	TP5544C20	27	1.182	3.5	32															
21	45:37.8	1	TP5544C20	27	1.18	3.4375	33															
22	45:38.3	1	TP5544C20	27	1.18	3.5	32															
23	45:38.8	1	TP5544C20	27	1.18	3.4375	34															
24	45:39.3	1	TP5544C20	27	1.184	3.4375	34															
25	45:39.8	1	TP5544C20	27	1.184	3.5	33															
26	45:40.3	1	TP5544C20	27	1.182	3.5	33															
27	45:40.8	1	TP5544C20	27	1.188	3.5	34															
28	45:41.3	1	TP5544C20	27	1.182	3.5	33															
29	45:41.8	1	TP5544C20	27	1.184	3.4375	35															
30	45:42.3	1	TP5544C20	27	1.182	3.4375	34															
31	45:42.8	1	TP5544C20	27	1.184	3.5	35															
32	45:43.3	1	TP5544C20	27	1.184	3.4375	34															

Figure 8-22. Data Log File

Selecting *PMBus Logging* (Figure 8-23) from the Tools drop-down menu enables the logging of all PMBus activity in the same way as the datalogging. This includes communications traffic for each polling loop between the GUI and the device. It also includes common operating values such as V_{OUT} , I_{OUT} , and temperature. The user is prompted to select a location for the file to be stored. See the next screen (Figure 8-24).

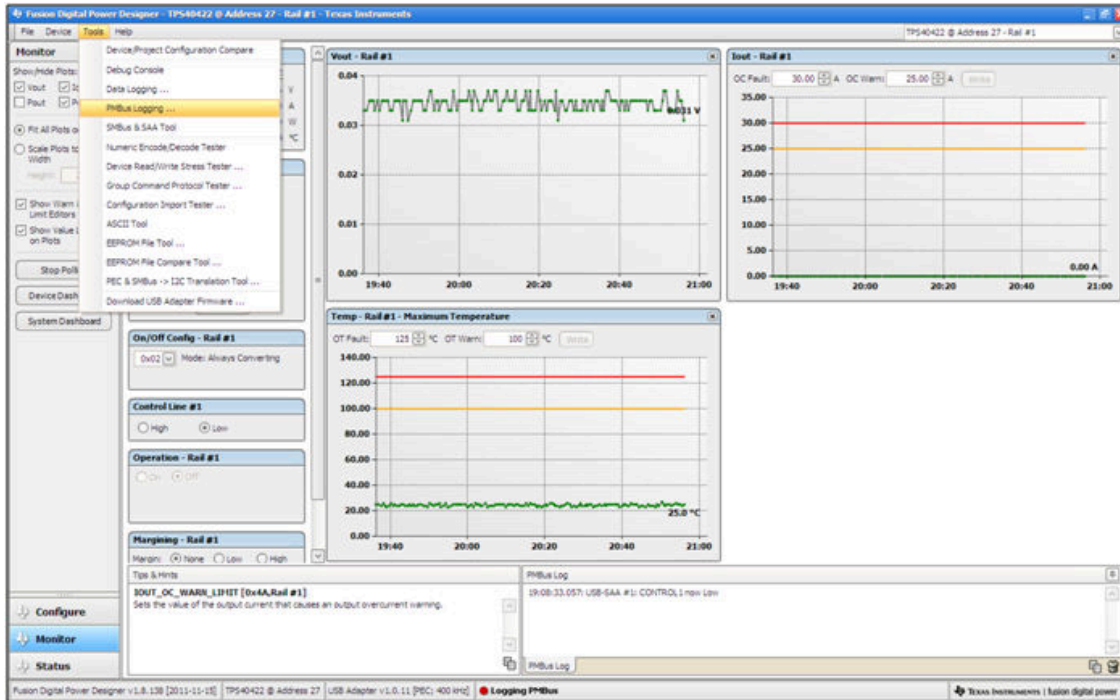

Figure 8-23. PMBus Logging

Select the storage location for the file and the type of file. As shown (Figure 8-24), the file is a CSV file to be stored in the directory path shown. Logging begins when the *Start Logging* button is selected, and stops when it is reselected (as *Stop Logging*). This file can rapidly grow in size, so caution is advised when using this function.

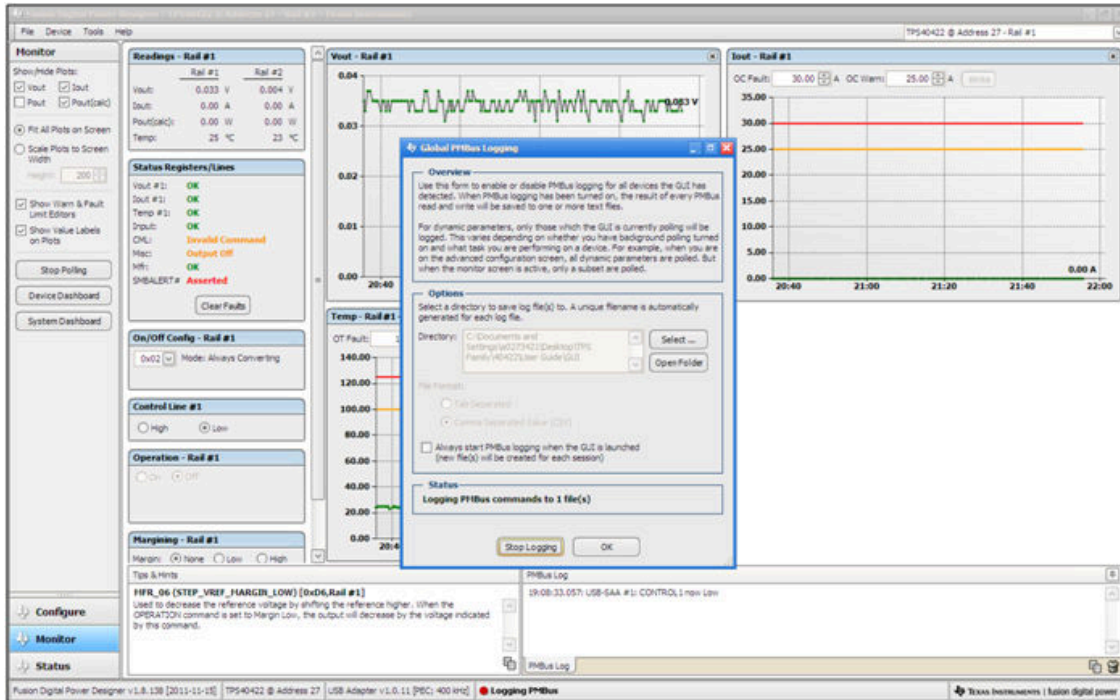

Figure 8-24. PMBus Log Details

Data is stored in a CSV file, with a date-stamp name (Figure 8-25).

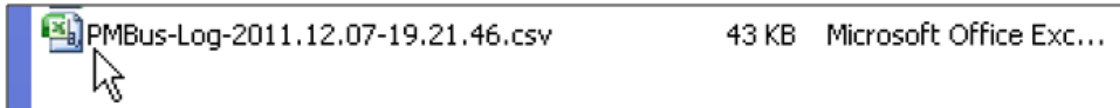

Figure 8-25. PMBus Log

9 EVM Assembly Drawing and PCB Layout

Figure 9-1 through Figure 9-5 show the design of the PWR-634EVM printed-circuit board (PCB).

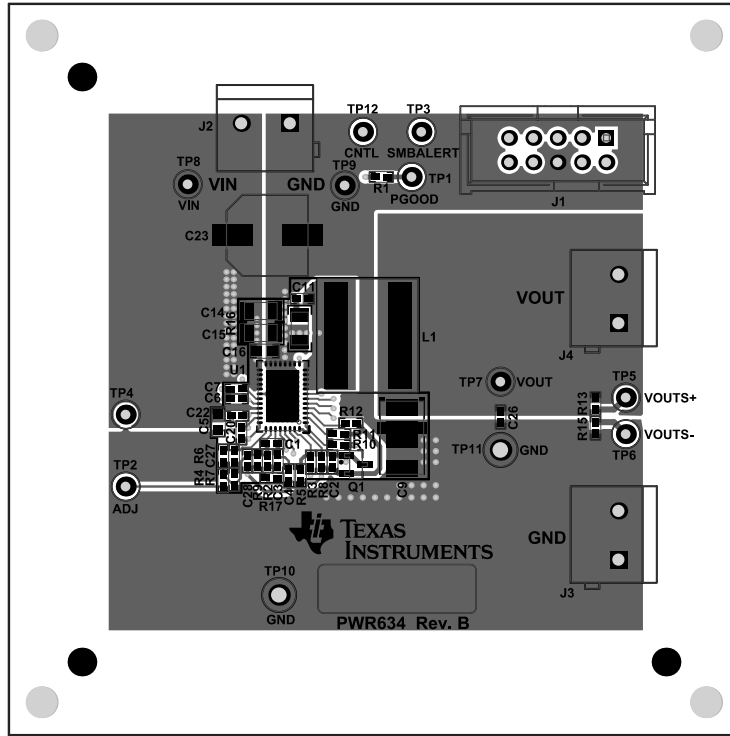

Figure 9-1. PWR-634EVM Top Layer Assembly Drawing (Top View)

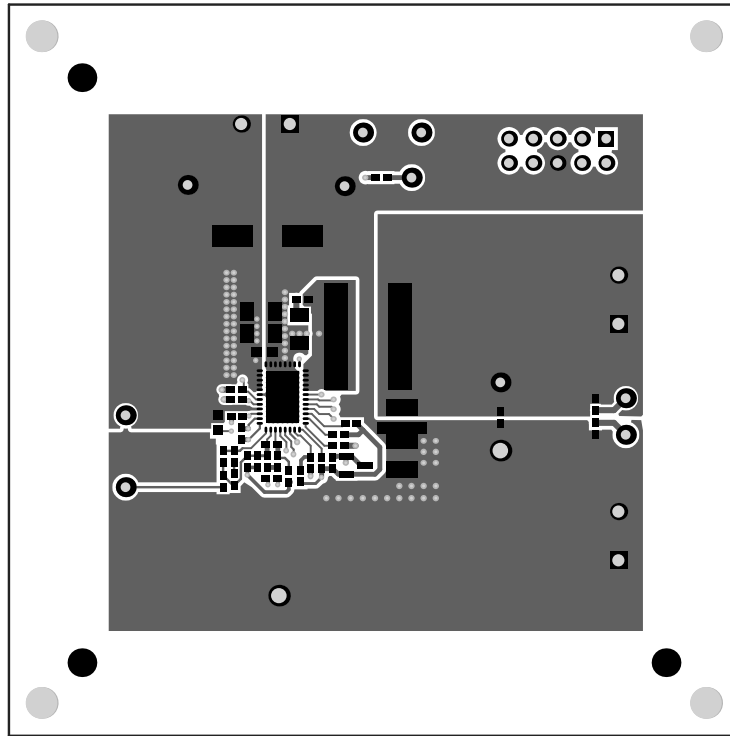

Figure 9-2. PWR-634EVM Top Copper

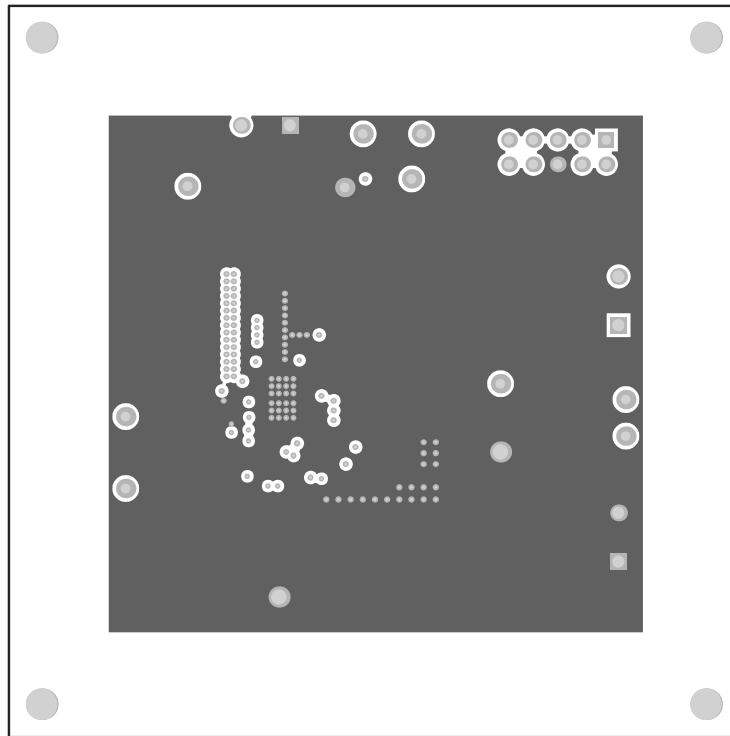

Figure 9-3. PWR-634EVM Layer 1 (Top View)

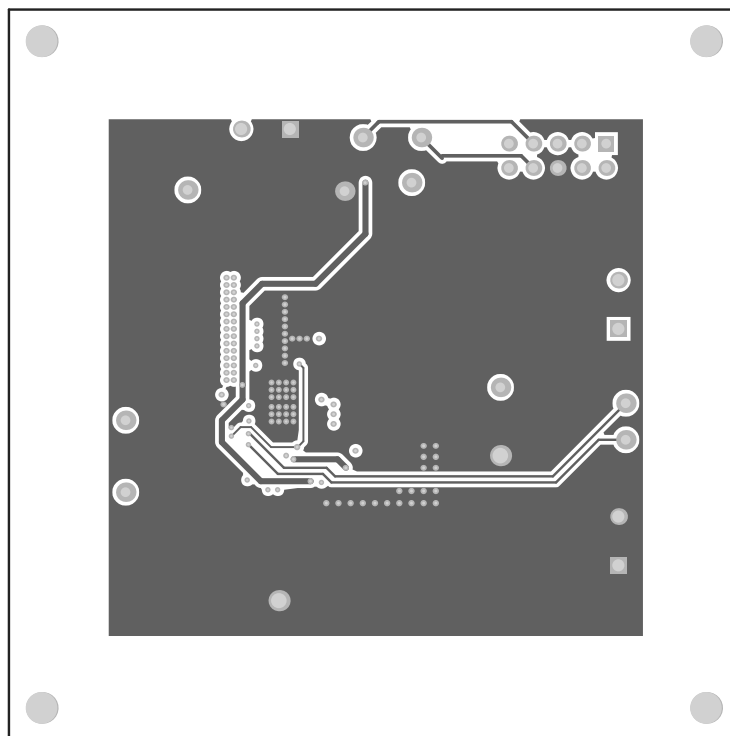

Figure 9-4. PWR-634EVM Layer 2 (Top View)

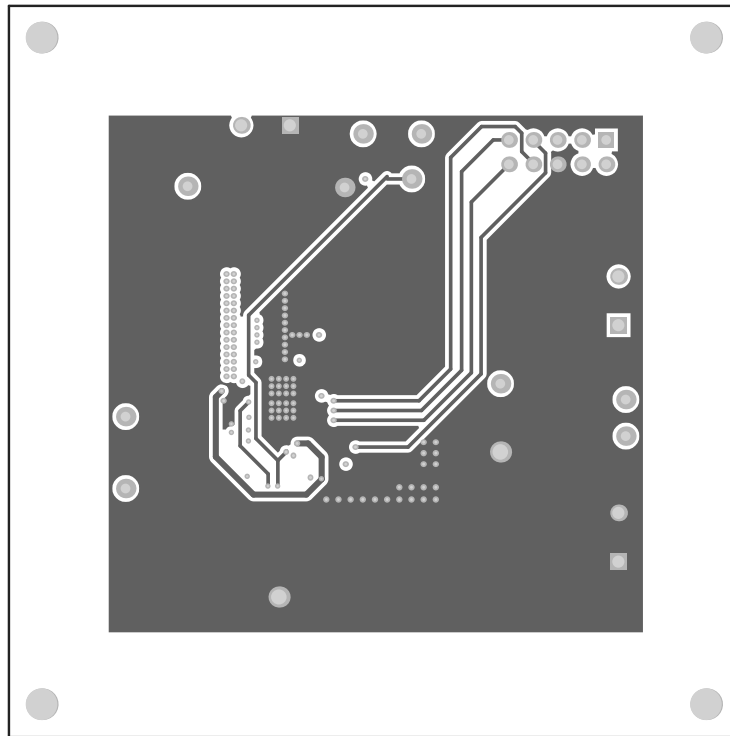

Figure 9-5. PWR-634EVM Layer 3 (Top View)

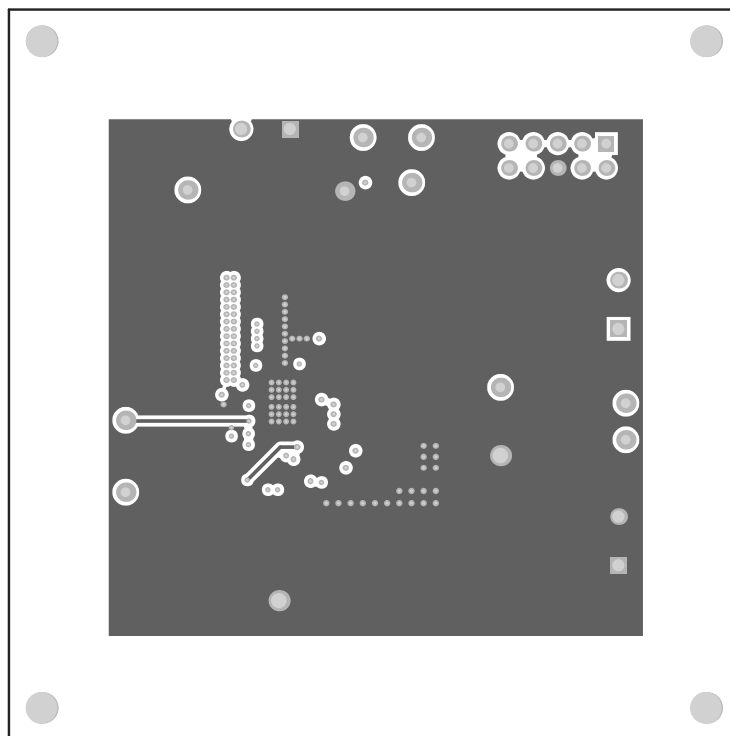

Figure 9-6. PWR-634EVM Layer 4 (Top View)

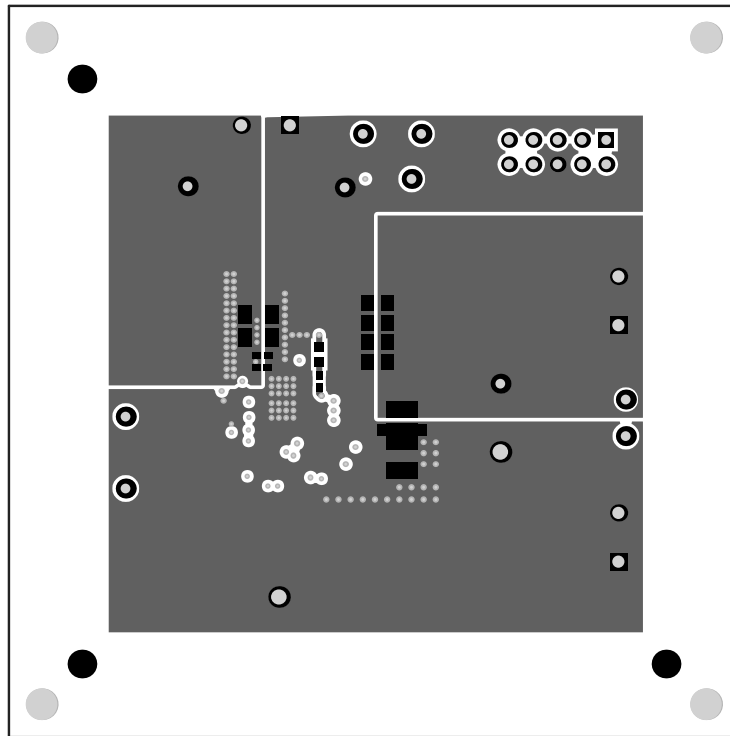

Figure 9-7. PWR-634EVM Bottom Copper (Top X-ray View)

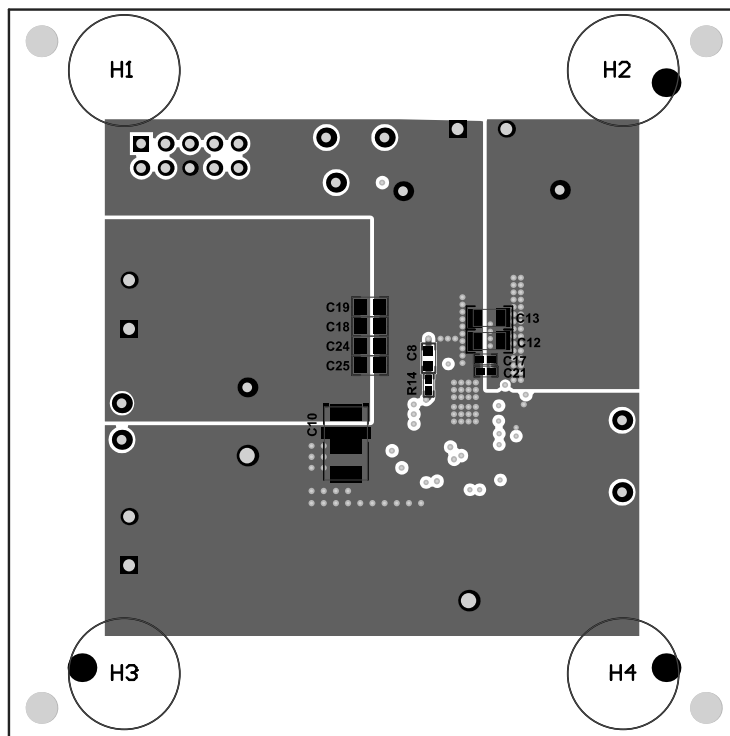

Figure 9-8. PWR-634EVM Bottom Assembly (Top X-ray View)

10 List of Materials

Table 10-1 lists the EVM components list according to Figure 3-1.

Note

The TPS544C20 version is used for this example.

Table 10-1. PWR091 List of Materials

DES	QTY	DESCRIPTION	PART NUMBER	MANUFACTURER
C2, C17, C21	3	Capacitor, ceramic, 1000 pF, 50 V, ±10%, X7R, 0402	C1005X7R1H102K	TDK
C4	1	Capacitor, ceramic, 0.01 µF, 25 V, ±10%, X7R, 0402	C1005X7R1E103K	TDK
C5	1	Capacitor, ceramic, 4.7 µF, 16 V, ±10%, X5R, 0603	GRM188R61C475KAA J	MuRata
C6	1	Capacitor, ceramic, 4.7 µF, 10 V, ±20%, X5R, 0402	GRM155R61A475M	MuRata
C7	1	Capacitor, ceramic, 0.1 µF, 10 V, ±10%, X5R, 0402	GRM155R61A104KA0 1D	MuRata
C8, C16	2	Capacitor, ceramic, 0.1 µF, 25 V, ±5%, X7R, 0603	C0603C104J3RACTU	Kemet
C9, C10	2	Capacitor, TA, 560uF, 2 V, +/-10%, 0.005 Ω, SMD	2TPLF560M5	Sanyo
C12, C13, C14, C15	4	Capacitor, ceramic, 10 µF, 25 V, ±10%, X7R, 1206	GRM31CR71E106KA1 2L	MuRata
C18, C19, C24, C25	4	Capacitor, ceramic, 47 µF, 6.3 V, ±20%, X5R, 0805	JMK212BJ476MG-T	Taiyo Yuden
C22, C26	2	Capacitor, ceramic, 1 µF, 25 V, ±10%, X5R, 0402	C1005X5R1E105K050 BC	TDK
C23	1	Capacitor, aluminum, 470 µF, 16 V, ±20%, Ω, SMD	EMVA160ADA471MH A0G	Nippon Chemi-Con
C1, C3	0	Capacitor, ceramic, 0.01 µF, 25 V, ±10%, X7R, 0402	C1005X7R1E103K	TDK
C11	0	Capacitor, ceramic, 1000 pF, 50 V, ±10%, X7R, 0402	C1005X7R1H102K	TDK
C20	1	Capacitor, ceramic, 120 pF, 50 V, ±5%, C0G/NP0, 0402	C1005C0G1H121J	TDK
C27	0	Capacitor, ceramic, 1000 pF, 50 V, ±10%, X7R, 0402	C1005X7R1H102K	TDK
C28	1	Capacitor, ceramic, 33 pF, 50 V, ±10%, C0G, 0402	C1005X7R1H330K	TDK
FID1, FID2, FID3	0	Fiducial mark. There is nothing to buy or mount.	N/A	N/A
H1, H2, H3, H4	4	Bumpon, hemisphere, 0.44 × 0.20, clear	SJ-5303 (CLEAR)	3M
J1	1	Header (shrouded), 100 mil, 5 × 2, gold, TH	5103308-1	TE Connectivity
J2, J3, J4	3	Terminal block 5.08 mm vert 2 pos	ED120/2DS	On-Shore Technology
L1	1	Inductor, Shielded, Composite, 400 nH, 36.8A, 0.0004 Ω, SMD	XAL1060-401MEB	Coilcraft
LBL1	1	Thermal transfer printable labels, 0.650" W x 0.200" H - 10,000 per roll	THT-14-423-10	Brady
!PCB	1	Printed circuit board	PWR634	Any
Q1	1	Transistor, NPN, 40 V, 0.2 A, SOT-23	MMBT3904	Fairchild Semiconductor

Table 10-1. PWR091 List of Materials (continued)

DES	QTY	DESCRIPTION	PART NUMBER	MANUFACTURER
R1, R17	2	Resistor, 100 k Ω , 1%, 0.063 W, 0402	CRCW0402100KFKE D	Vishay-Dale
R3, R10, R14	3	Resistor, 0 Ω , 5%, 0.063 W, 0402	CRCW04020000Z0ED	Vishay-Dale
R6	1	Resistor, 20.0 k Ω , 1%, 0.063 W, 0402	CRCW040220K0FKE D	Vishay-Dale
R13, R15, R18	3	Resistor, 49.9 Ω , 1%, 0.063 W, 0402	CRCW040249R9FKE D	Vishay-Dale
R9	1	Resistor, 30.1 k Ω , 1%, 0.063 W, 0402	CRCW040230K1FKE D	Vishay-Dale
R2, R4	0	Resistor, 20.0 k Ω , 1%, 0.063 W, 0402	CRCW040220K0FKE D	Vishay-Dale
R5	0	Resistor, 0 Ω , 5%, 0.063 W, 0402	CRCW04020000Z0ED	Vishay-Dale
R16	0	Resistor, 1.0 Ω , 5%, 0.25 W, 1206	CRCW12061R00JNEA	Vishay-Dale
R8, R11, R12	3	Resistor, 38.3 k Ω , 1%, 0.063 W, 0402	CRCW040238K3FKE D	Vishay-Dale
TP1, TP2, TP3, TP4, TP5, TP6, TP7, TP8, TP12	11	Test point, miniature, red, TH	5000	Keystone
TP9, TP10, TP11	3	Test point, miniature, black, TH	5001	Keystone
U1	1	TPS544C20 18-V, 30-A PMBus Synchronous Buck Converters, RVF0040A	TPS544C20RVF	Texas Instruments

11 Revision History

NOTE: Page numbers for previous revisions may differ from page numbers in the current version.

Changes from Revision A (June 2014 August 2021) to Revision B ()	Page
• Changed user's guide title.....	2
• Updated the numbering format for tables, figures, and cross-references throughout the document.	2
• Edited user's guide for clarity	2
<hr/>	
Changes from Revision * (May 2014) to Revision A (June 2014)	Page
• Added updated PWR-634EVM Schematic drawings.....	4
• Added updated EVM Assembly Drawings and PCB Layout drawings.....	31
• Changed List of Materials.....	35

IMPORTANT NOTICE AND DISCLAIMER

TI PROVIDES TECHNICAL AND RELIABILITY DATA (INCLUDING DATA SHEETS), DESIGN RESOURCES (INCLUDING REFERENCE DESIGNS), APPLICATION OR OTHER DESIGN ADVICE, WEB TOOLS, SAFETY INFORMATION, AND OTHER RESOURCES "AS IS" AND WITH ALL FAULTS, AND DISCLAIMS ALL WARRANTIES, EXPRESS AND IMPLIED, INCLUDING WITHOUT LIMITATION ANY IMPLIED WARRANTIES OF MERCHANTABILITY, FITNESS FOR A PARTICULAR PURPOSE OR NON-INFRINGEMENT OF THIRD PARTY INTELLECTUAL PROPERTY RIGHTS.

These resources are intended for skilled developers designing with TI products. You are solely responsible for (1) selecting the appropriate TI products for your application, (2) designing, validating and testing your application, and (3) ensuring your application meets applicable standards, and any other safety, security, regulatory or other requirements.

These resources are subject to change without notice. TI grants you permission to use these resources only for development of an application that uses the TI products described in the resource. Other reproduction and display of these resources is prohibited. No license is granted to any other TI intellectual property right or to any third party intellectual property right. TI disclaims responsibility for, and you will fully indemnify TI and its representatives against, any claims, damages, costs, losses, and liabilities arising out of your use of these resources.

TI's products are provided subject to [TI's Terms of Sale](#) or other applicable terms available either on ti.com or provided in conjunction with such TI products. TI's provision of these resources does not expand or otherwise alter TI's applicable warranties or warranty disclaimers for TI products.

TI objects to and rejects any additional or different terms you may have proposed.

Mailing Address: Texas Instruments, Post Office Box 655303, Dallas, Texas 75265
Copyright © 2022, Texas Instruments Incorporated