

Maximizing Power Conversion and Motor Control Efficiency With Isolated Voltage Sensing

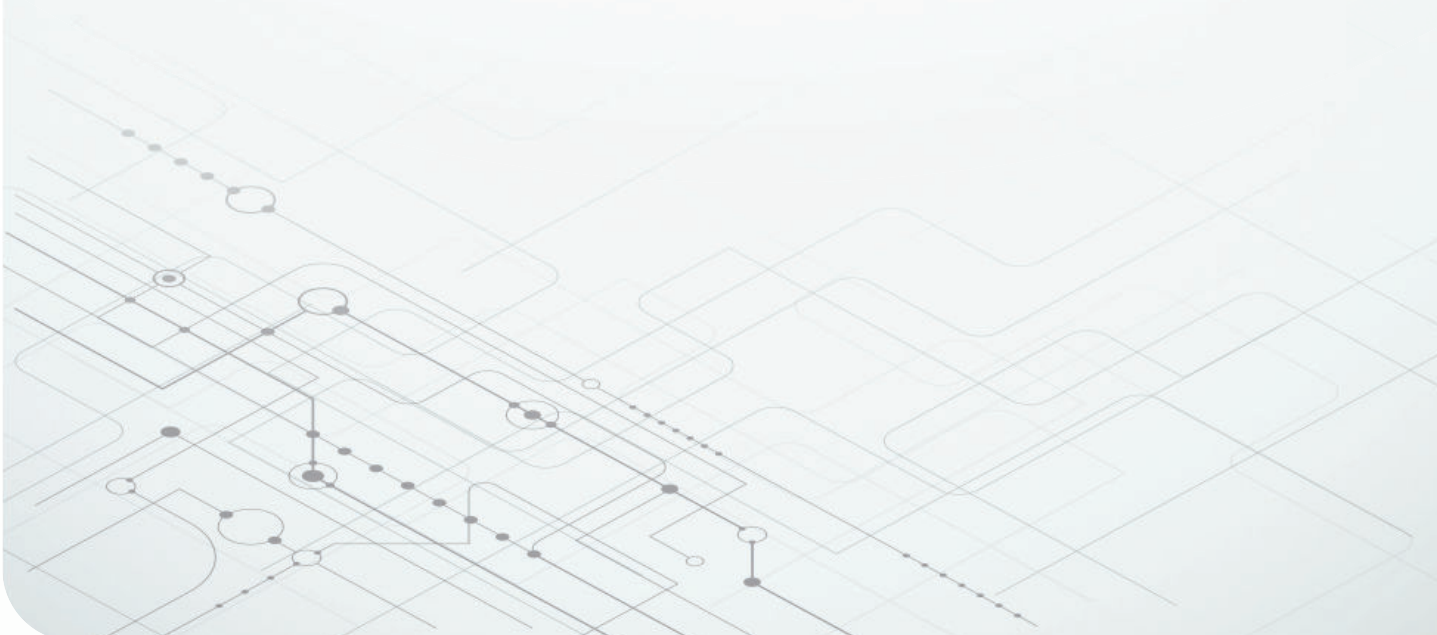

Kia Rahbar
Product Marketing Manager
TI's Isolated Converters



With growing demand to harvest more renewable energy sources expanding across automotive and industrial applications, the need for small, efficient, accurate and cost-effective power converters and motor controllers is increasing at an unprecedented rate.

Accurate, isolated voltage sensing to measure high voltages presents a significant electrical engineering challenge – and the voltages are only getting higher. DC voltages are increasing from $400V_{DC}$ to $800V_{DC}$ and even as high as $1,500V_{DC}$. Affordability for consumers is also becoming increasingly important, and size optimization is pushing for greater innovation. Thus, a precise, size-optimized, galvanically isolated voltage-sensing device that meets today's requirements is becoming mandatory.

Automakers annually state goals to develop electric vehicles (EVs) that support a longer driving range (>400 miles) and provide better operational safety, while maintaining affordability. Integrated, isolated DC voltage-sensing devices can maximize DC voltage measurements and enable longer driving ranges by providing less than 1% accuracy error of the DC battery voltage in onboard chargers, DC/DC converters and battery-management systems. Integrated, isolated AC voltage-sensing devices can accurately measure single- or three-phase AC grid voltages in a compact integrated circuit (IC), maximizing grid use of the voltage levels. Both AC and DC isolated voltage sensing devices can provide operational safety by detecting functional failures and notifying drivers. AC and DC isolated voltage sensing devices can also enable affordability by integrating external components into a single IC, helping designers accelerate time to market with more energy-efficient designs.

In a smart energy infrastructure, isolated voltage-sensing devices with advanced integration can enable cost reduction and increased power density in DC and AC chargers, energy storage systems, and solar inverters. These isolated voltage-sensing devices can also enable high-accuracy voltage measurements with less than 1%

accuracy error for more precise power delivery and lower power dissipation. The improved efficiency then makes it possible to pass the cost savings on to consumers.

Energy infrastructure applications require both AC and DC voltage measurements.

For AC voltage sensing, an accurate isolated voltage sensor allows for a more precise measurement of the grid voltage, which is important for power converters because you need to know the phase difference between each voltage in order to perform power factor correction. In inverter mode, isolated voltage sensors provide precise voltage levels to the load, grid, or both.

For DC voltage sensing, an accurate isolated voltage sensor helps facilitate faster charge during the constant voltage phase when charging the battery to the final voltage, without damaging the battery.

Figure 1 shows an example of where isolated voltage sensing occurs in electric vehicles and energy infrastructure.



Figure 1. Isolated voltage sensing in EVs and energy infrastructure systems.

In today's motor-control applications, including industrial motor drives and automotive traction inverters, there is a growing need for more accurate measurements of the DC voltage. A highly accurate and compact IC can enable more efficient DC measurements and not take up much space on the printed circuit board (PCB), which are both challenges in motor-control applications.

Solutions for high-voltage sensing

At TI, there is a strong emphasis on developing products to help solve market challenges and enable more efficient, cost-effective and accurate power-conversion and motor-control systems. We have developed two new isolated voltage-sensing technologies, including integrated high-voltage resistor and single-ended output devices.

Integrated resistor devices

The **AMC0380D04-Q1**, **AMC0381D10-Q1** and **AMC0386M10-Q1** family of galvanically isolated voltage sensing amplifiers and modulators integrate high-voltage resistive dividers and eliminate the need for large and expensive external resistors to step down the voltage to a $\pm 1V$ or $0V$ to $2V$ level. Stand-alone high-voltage resistors can take up a lot of space on PCBs, given that you may need as many as 15 high-voltage resistors to step down the voltage and maintain the system's isolation ratings. Stand-alone high-voltage resistors are also a significant source of measurement error, lifetime drift and temperature drift, and require end-of-line calibration.

When it comes to conserving board space, the AMC0380D04-Q1 $\pm 400V_{AC}$ input isolated amplifier, AMC0381D10-Q1 $1,000V_{DC}$ input isolated amplifier and AMC0386M10-Q1 $\pm 1,000V_{AC}$ input isolated modulator save system-level costs and reduce solution size as much as 50% by removing the need for external high-voltage resistors, as shown in **Figure 2**.

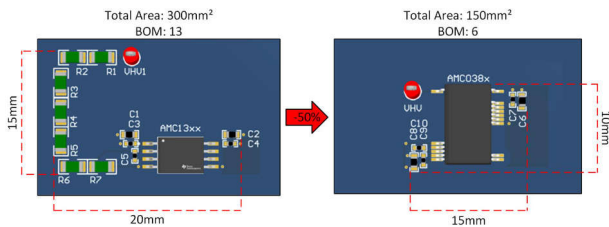

Figure 2. Integration benefits of the integrated resistor family.

Integrating the high-voltage resistors into our isolated voltage-sensing devices eliminates the need for a large

resistor ladder. We've also eliminated the need for system-level calibration by calibrating out the gain error of the internal resistor for the AMC0380D04-Q1, AMC0381D10-Q1 and AMC038610-Q1 in our factories, which can save you manufacturing time and costs.

These devices can also help increase system efficiency through improved accuracy. The integrated divider features very low temperature and lifetime drift compared to discrete resistors, enabling voltage measurements with an accuracy $<1\%$.

For more information on integrated resistor devices, see the application note, **Increased Accuracy and Performance with Integrated High Voltage Resistor Isolated Amplifiers and Modulators**.

Single-ended output devices

When designing isolated voltage-sensing circuits with industry-standard isolated amplifiers such as the AMC1311, a common challenge is converting the differential output of the isolated amplifier to single ended in order to interface directly with the analog-to-digital converter (ADC) inside the microcontroller (MCU). This can be costly and consume extra PCB space.

To conserve board space, the **AMC0311R-Q1**, **AMC0311S-Q1**, **AMC0330R-Q1** and **AMC0330S-Q1** devices help save system-level costs and reduce solution size by removing the need for a differential-to single-ended conversion circuit, which typically consists of an operational amplifier and a reference voltage (see **Figure 3**).

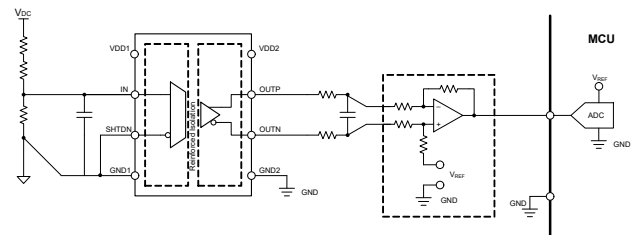

Figure 3. Traditional isolated voltage-sensing topology.

Figure 4 shows the pinout of these single-ended devices.

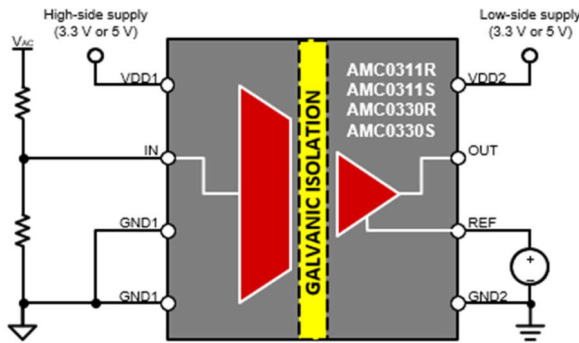

Figure 4. Integration of the differential- to single-ended operational amplifier.

Along with the board space savings that come with the AMC0311R-Q1 and AMC0330R-Q1 devices, their ratiometric output enables a variable output gain, providing an output swing from the isolated voltage-sensing device that follows the reference voltage of the ADC inside the MCU, as shown in Figure 5. This enables the use of the ADC's full dynamic range for improved resolution measurements.

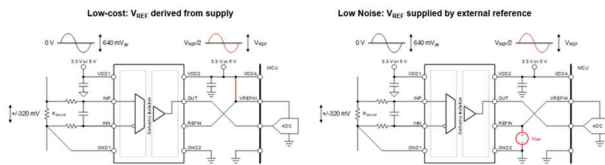

Figure 5. Ratiometric output isolated voltage sensing.

For more information on integrated resistor devices, see the application note, [Isolated Amplifiers with Differential, Single-Ended Fixed Gain and Ratiometric Outputs for Voltage Sensing Applications](#).

Integrated isolated voltage-sensing use cases

Figure 6 shows the standard topology of a power-conversion system. For AC voltage sensing, you can use the AMC0380D04-Q1 without external high-voltage resistors (the green rectangle) or the AMC0330D-Q1, AMC0330S-Q1 or AMC0330R-Q1 with external high-voltage resistors (the yellow rectangle).

For DC voltage sensing, you can use the AMC0381D10-Q1 and AMC0386M10-Q1 without external high-voltage resistors (the blue rectangles) or the AMC0311D-Q1, AMC0311S-Q1 or AMC0311R-Q1 with external high-voltage resistors (the red rectangles).

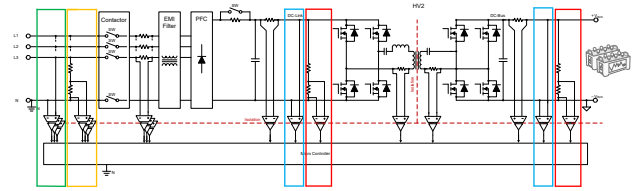

Figure 6. Isolated voltage sensing in power-conversion applications.

Figure 7 shows the standard topology of a motor-control system. For AC voltage sensing, you can use the AMC0380D04-Q1 without external high-voltage resistors (the green rectangle) or the AMC0330D-Q1, AMC0330S-Q1 or AMC0330R-Q1 with external high-voltage resistors (the yellow rectangle).

For DC voltage sensing, you can use the AMC0381D10-Q1 and AMC0386M10-Q1 without external high-voltage resistors (the blue rectangle) or the AMC0311D-Q1, AMC0311S-Q1 or AMC0311R-Q1 with external high-voltage resistors (the red rectangle).

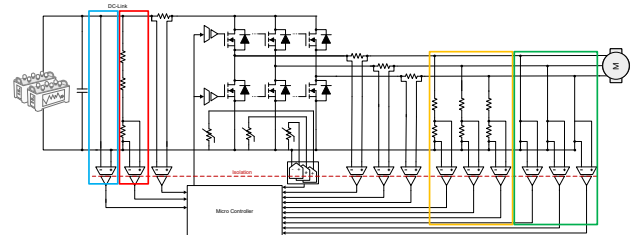

Figure 7. Isolated voltage sensing in motor-control applications.

Conclusion

Small, efficient, accurate and cost-effective power converters and motor controllers are a necessity in today's market. The AMC0380D04-Q1, AMC0386M10-Q1, AMC0330D-Q1, AMC0330S-Q1 and AMC0330R-Q1 devices for AC voltage sensing and the AMC0381D-Q1, AMC038610-Q1, AMC0311D-Q1, AMC0311S-Q1 and AMC0311R-Q1 devices for DC voltage sensing address design challenges to help realize the goal of a net-zero emissions future.

Additional resources

- Check out the updated reference designs with high-voltage sensing products:
 - 800V, 300kW SiC-based traction inverter system reference design (download the [TIDM-02014](#))
 - 10-kW, bidirectional three-phase three-level (T-type) inverter and PFC reference design (download the [TIDA-01606](#))
- Get started designing by ordering the [AMC038XEVM](#) evaluation module and [DIYAMC-0-EVM](#) evaluation modules.
- Learn more about TI's [voltage sensing solutions](#).

Important Notice: The products and services of Texas Instruments Incorporated and its subsidiaries described herein are sold subject to TI's standard terms and conditions of sale. Customers are advised to obtain the most current and complete information about TI products and services before placing orders. TI assumes no liability for applications assistance, customer's applications or product designs, software performance, or infringement of patents. The publication of information regarding any other company's products or services does not constitute TI's approval, warranty or endorsement thereof.

All trademarks are the property of their respective owners.

IMPORTANT NOTICE AND DISCLAIMER

TI PROVIDES TECHNICAL AND RELIABILITY DATA (INCLUDING DATA SHEETS), DESIGN RESOURCES (INCLUDING REFERENCE DESIGNS), APPLICATION OR OTHER DESIGN ADVICE, WEB TOOLS, SAFETY INFORMATION, AND OTHER RESOURCES "AS IS" AND WITH ALL FAULTS, AND DISCLAIMS ALL WARRANTIES, EXPRESS AND IMPLIED, INCLUDING WITHOUT LIMITATION ANY IMPLIED WARRANTIES OF MERCHANTABILITY, FITNESS FOR A PARTICULAR PURPOSE OR NON-INFRINGEMENT OF THIRD PARTY INTELLECTUAL PROPERTY RIGHTS.

These resources are intended for skilled developers designing with TI products. You are solely responsible for (1) selecting the appropriate TI products for your application, (2) designing, validating and testing your application, and (3) ensuring your application meets applicable standards, and any other safety, security, regulatory or other requirements.

These resources are subject to change without notice. TI grants you permission to use these resources only for development of an application that uses the TI products described in the resource. Other reproduction and display of these resources is prohibited. No license is granted to any other TI intellectual property right or to any third party intellectual property right. TI disclaims responsibility for, and you will fully indemnify TI and its representatives against, any claims, damages, costs, losses, and liabilities arising out of your use of these resources.

TI's products are provided subject to [TI's Terms of Sale](#) or other applicable terms available either on [ti.com](https://www.ti.com) or provided in conjunction with such TI products. TI's provision of these resources does not expand or otherwise alter TI's applicable warranties or warranty disclaimers for TI products.

TI objects to and rejects any additional or different terms you may have proposed.

Mailing Address: Texas Instruments, Post Office Box 655303, Dallas, Texas 75265
Copyright © 2024, Texas Instruments Incorporated