

# DS50PCI401EVK User Guide

## PCI Express SMA Evaluation Kit

---

### General Description:

The DS50PCI401EVK – PCI Express (PCIe) SMA evaluation kit provides a complete high bandwidth platform to evaluate the signal integrity and signal conditioning features of the National Semiconductor DS50PCI401 – Quad Lane PCI Express transceiver with Equalization and De-emphasis.

SMA edge launch connectors are used as the input and the output connections for this evaluation board. Commercially available adaptor boards can be purchased to facilitate connection to PCIe cables or backplane interconnects.

### Features:

- Quad lane bi-directional transceiver up to 5.0 Gbps rate
- Signal conditioning on inputs and outputs for extended reach
- Adjustable receive equalization up to +26 dB gain
- Adjustable transmit de-emphasis up to -12 dB
- Adjustable transmit VOD (600 mVp-p to 1200 mVp-p)
- <0.15 UI of residual DJ at 5.0 Gbps with 40" FR4 trace
- Automatic de-emphasis scaling based on rate detect
- PCIe: Beacon signal pass-through,
- Adjustable electrical IDLE detect threshold
- Low power (100 mW/channel), per-channel power down
- Programmable via pin selection or SMBus interface
- Single supply operation at 2.5V ±5%
- >6 kV HBM ESD Rating
- 3.3V LVCMOS input tolerant for SMBus interface
- High speed signal flow-thru pinout package: 54-pin LLP (10 mm x 5.5 mm)

### Applications:

- PCIe (2.5 Gbps / 5.0 Gbps)
- Will also support other AC coupled 8b/10b encoded serial standards under 5.0 Gbps

### DS64BR401EVK Demo Kit Contents:

- End User License Agreement
- DS50PCI401EVK User Guide Rev.1.0
- DS50PCI401 Datasheet
- DS50PCI401EVK PCB

### Ordering Information:

**DEVICE:** DS50PCI401SQ – QTY = 2000, DS50PCI401SQE – QTY = 250  
**SMA Evaluation Kit:** DS50PCI401EVK



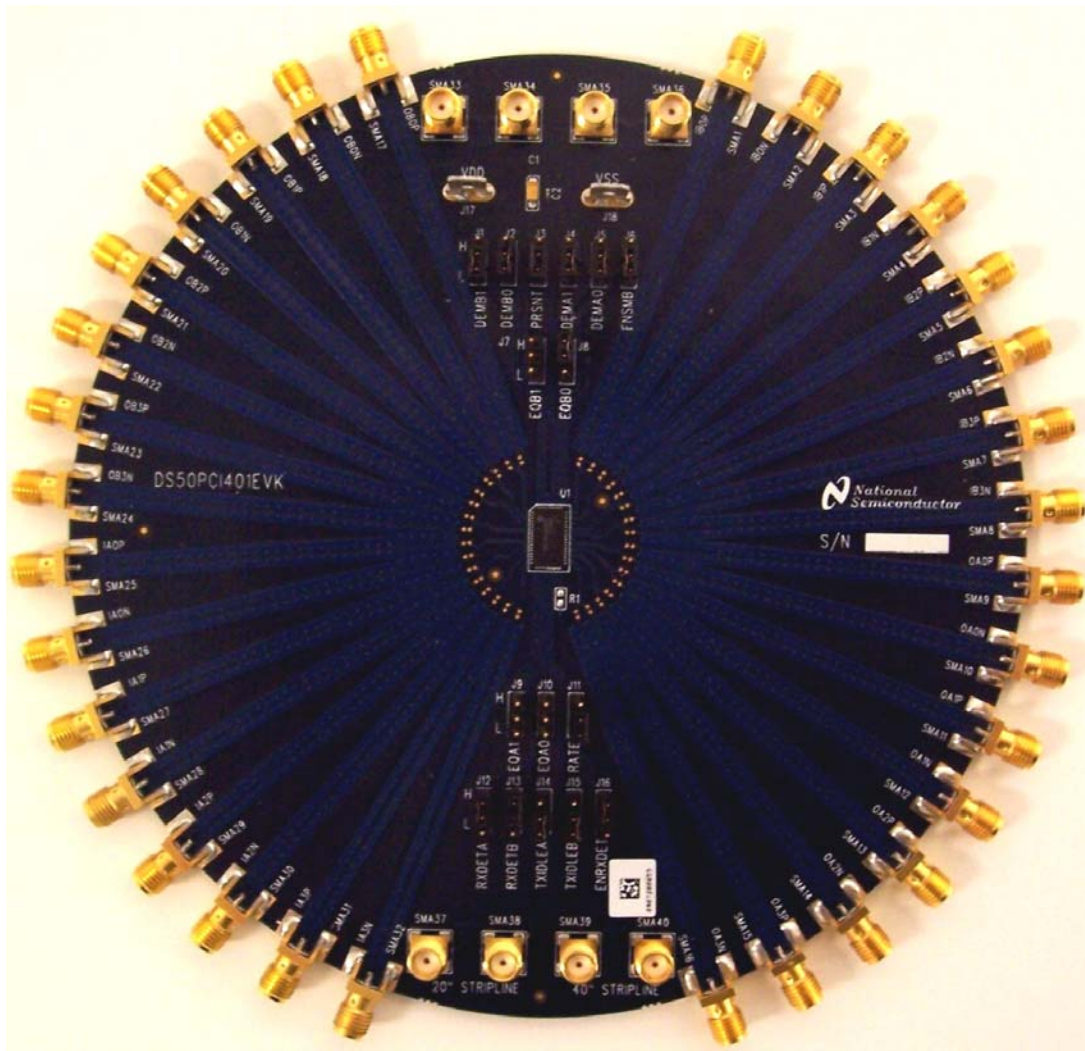
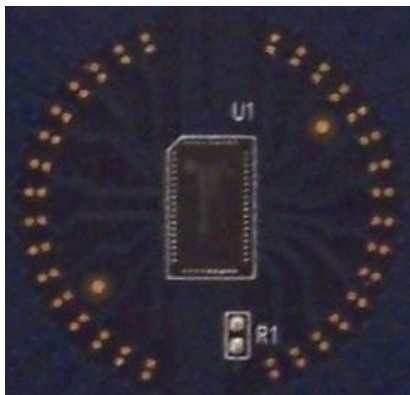

Figure 1. DS50PCI401EVK Evaluation Board

## Quick Start Guide:

1. Connect -> 2.5V DC power to J17 and GND to J18. Verify supply voltage levels with a multi-meter prior to connection. VDD levels in excess of the Absolute Maximum will likely damage the device.
2. Attach 50 Ohm SMA cables to the board. Input and output cables must be AC coupled to most test equipment for optimum results. AC coupling can be accomplished with external units similar to the Picosecond Pulse Labs 5508-110. Alternatively, a location for on-board AC coupling is provided. The connecting trace between the 0402 SMT pads must be severed prior to capacitor installation.



**Figure 2. AC coupling location**

3. Set EQ and DE level according to the attenuation characteristics of the inter-connect media.

### Connection and Control Description

Component	Name	Level	Function
J17	VDD		DC Power – VIN direct to DS50PCI401
J18	VSS		GND – direct to DS50PCI401 and edge launch SMAs
J6	ENSMB	0	Optional SMBus access pins. See datasheet for additional information.
J1 - J2 and J4 - J5	DEM	00	Control pins for De-emphasis. (Default = 0 dB)
J7 - J8 and J9 - J10	EQ	FF	Control pins for Equalization. (Default = Bypass)
J3	PRSNT	0	Control pin for PCIe PRSNT signal.
J11	RATE		Control pin for RATE (2.5 Gbps or 5 Gbps).
J12, J13	RXDET	1	Control pins for RXDET (50 Ohm or Hi-Z to VDD).
J18	ENRXDET	1	Must be held HIGH for RXDET to operate.
J14, J15	TXIDLE	0	Control pins for TXIDLE

### J17, J18 – Power Connection

VDD (2.375 – 2.625V) on J17 is needed for power. GND must also be connected to J18 / VSS.

### J6 – SMBus Access

J6 is used to access the SMBus to configure the DS50PCI401. ENSMB should be tied low for external pin control. When ENSMB is tied high, SCL (clock input) and SDA (data input/output) are enabled.

### Other Control Pins

Jumpers should be used to tie the control pins to 1-high (VDD), 0-low (GND) or F-float (NC). The EQA, EQB, DEMA, DEMB, RATE, TXIDLEA, and TXIDLEB are 3-level inputs. PRSNT is used to enable and disable the device and should be tied low (GND) for normal operation. RXDET is used to set the input termination impedance to VDD. Please refer to the tables below for detail information.



**Equalization Control Pins (EQA/EQB)**

EQA/B1	EQA/B0	Equalization Level	Recommend Media Length
F	F	Off	Bypass
1	1	4 dB at 2.5 GHz	8 inch FR4 or 0.7 meter (28AWG) PCIe cable
0	0	9.6 dB at 2.5 GHz	14 inch FR4 or 1-3 meters (28AWG) PCIe cable
F	0	11.4 dB at 2.5 GHz	20 inch FR4 or 5 meter (26AWG) PCIe cable
1	0	15.5 dB at 2.5 GHz	30 inch FR4 or 7 meter (24AWG) PCIe cable
F	1	17.0 dB at 2.5 GHz	40 inch FR4 or 9 meter (24AWG) PCIe cable
0	1	19.1 dB at 2.5 GHz	50 inch FR4 or 10 meter (24AWG) PCIe cable
0	F	20.6 dB at 2.5 GHz	15 meter (24AWG) PCIe cable
1	F	26.3 dB at 2.5 GHz	>15 meter (24AWG) PCIe cable

**De-emphasis Control Pins (DEMA/DEMB)**

DEMA1/B1	DEMA0/B0	De-emphasis Level	VOD Level
0	0	0 dB	VOD: 600 mV to 1200 mV
0	1	-3.5dB	VOD = 1000 mV
1	0	-6.0 dB	VOD = 1000 mV
1	1	-6.0 dB enhanced	VOD = 1000 mV
0	F	-9.0 dB enhanced	VOD = 1000 mV
1	F	-12.0 dB enhanced	VOD = 1000 mV
F	0	-9.0 dB enhanced	VOD = 1200 mV
F	1	-12.0 dB enhanced	VOD = 1400 mV
F	F	Reserved, don't use	

**Rate Control Pins (RATE)**

RATE	Functional Description
0	Set the De-emphasis pulse width duration for 2.5 Gbps (low rate)
1	Set the De-emphasis pulse width duration for 5.0 Gbps (high rate).
F	Enables the auto rate select function.

**TX Output Control Pins (TXIDLEA/TXIDLEB)**

TXIDLEA/B	Functional Description
0	Disables the signal detect/squelch function for all outputs A or B.
1	Forces all outputs to be muted (electrical idle).
F	Enables the signal detect/squelch function for all channels. Signal detect voltage level threshold can be adjusted with an external resistor on the SD_TH pin to GND. Default level is 130 mVp-p when SD_TH is floating. Please refer to Figure 1 in the datasheet for typical resistor value.

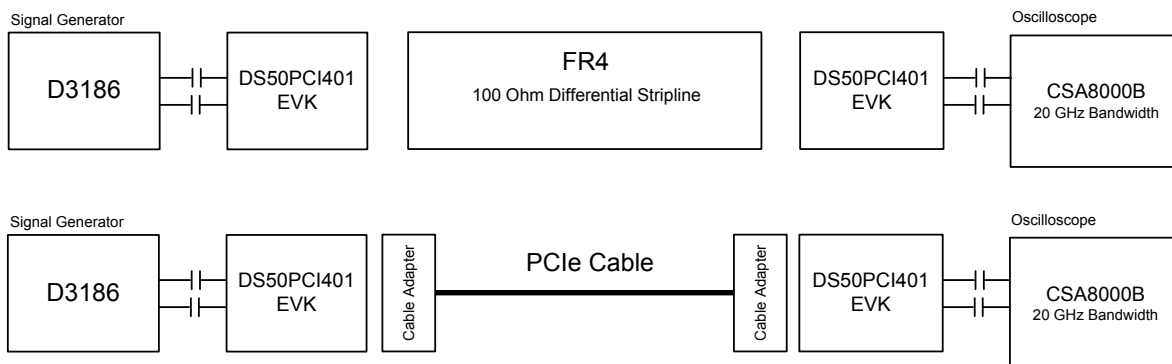
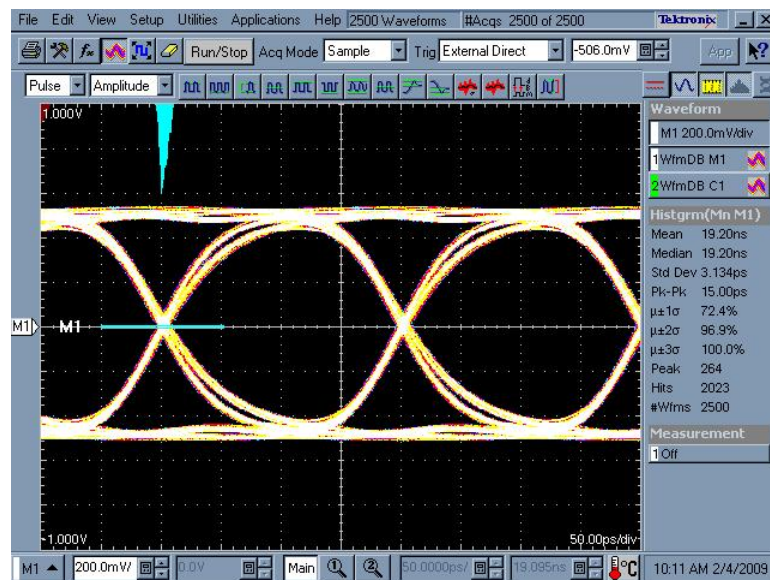

Figure 3. DS50PCI401EVK Equalization Test Setup

### Typical Results:

#### DS50PCI401 Device Performance with 3" EVK trace at 5.0 Gbps: OUTPUT (EVK Trace Only)



DS50PCI401 Setup condition:  
 Input Data: PRBS7  
 EQ[1:0] = FF (Bypass or Off)  
 DEM[1:0] = 00 (-0 dB with VOD = 1.0 Vp-p)

## DS50PCI401 Equalization Performance at 5.0 Gbps:

### Recovered Output – 3 Meters 28 AWG PCIe Cable

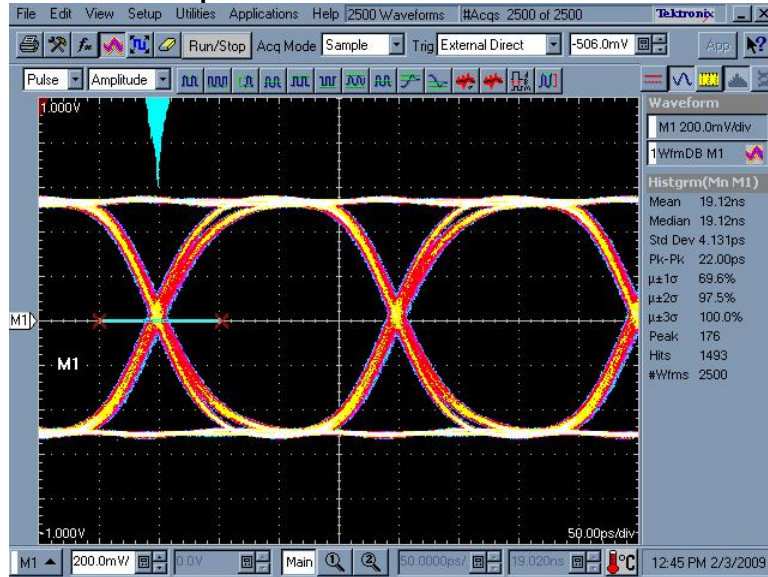

DS50PCI401 Setup condition:

Input Data: PRBS7

EQ[1:0] = 00 (9.6 dB at 2.5 GHz)

DEM[1:0] = 00 (0 dB with VOD = 1.0 Vp-p)

### Recovered Output – 5 Meters 26 AWG PCIe Cable

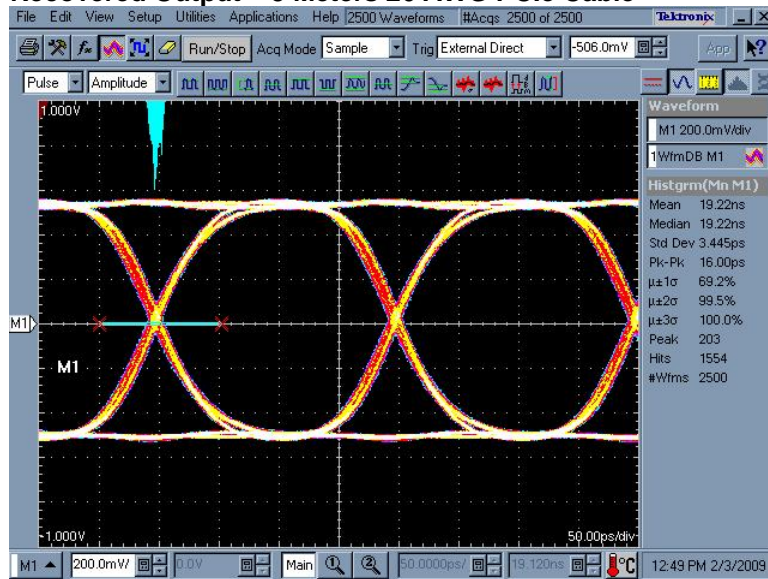

DS50PCI401 Setup condition:

Input Data: PRBS7

EQ[1:0] = F0 (11.4 dB at 2.5 GHz)

DEM[1:0] = 00 (0 dB with VOD = 1.0 Vp-p)



## DS50PCI401 Equalization Performance at 5.0 Gbps:

### Recovered Output – 7 Meters 24 AWG PCIe Cable

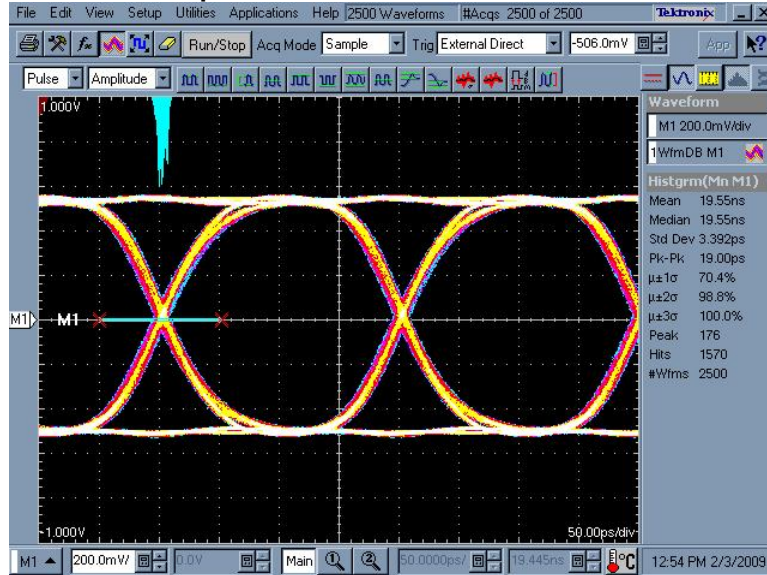

DS50PCI401 Setup condition:

Input Data: PRBS7

EQ[1:0] = 10 (15.5 dB at 2.5 GHz)

DEM[1:0] = 00 (0 dB with VOD = 1.0 Vp-p)

### Recovered Output – 15 Meters 24 AWG PCIe Cable

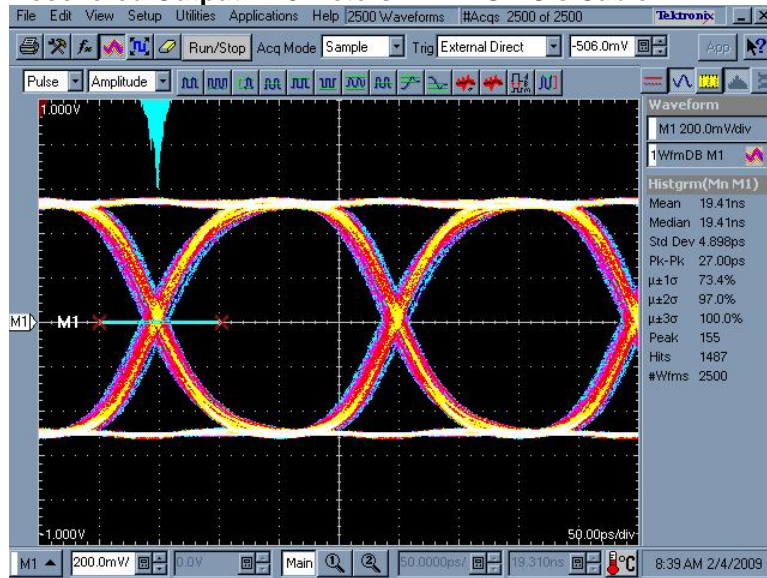

DS50PCI401 Setup condition:

Input Data: PRBS7

EQ[1:0] = 0F (20.6 dB at 2.5 GHz)

DEM[1:0] = 00 (0 dB with VOD = 1.0 Vp-p)



## DS50PCI401 Equalization Performance at 5.0 Gbps:

### Recovered Output – 10" FR4 (100 Ohm Differential Stripline)

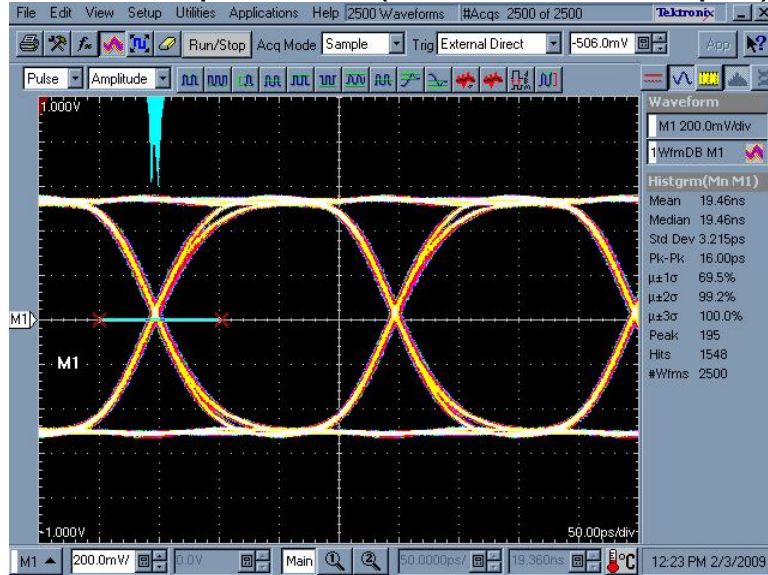

DS50PCI401 Setup condition:

Input Data: PRBS7

EQ[1:0] = 11 (4 dB at 2.5 GHz)

DEM[1:0] = 00 (0 dB with VOD = 1.0 Vp-p)

### Recovered Output – 20" FR4 (100 Ohm Differential Stripline)

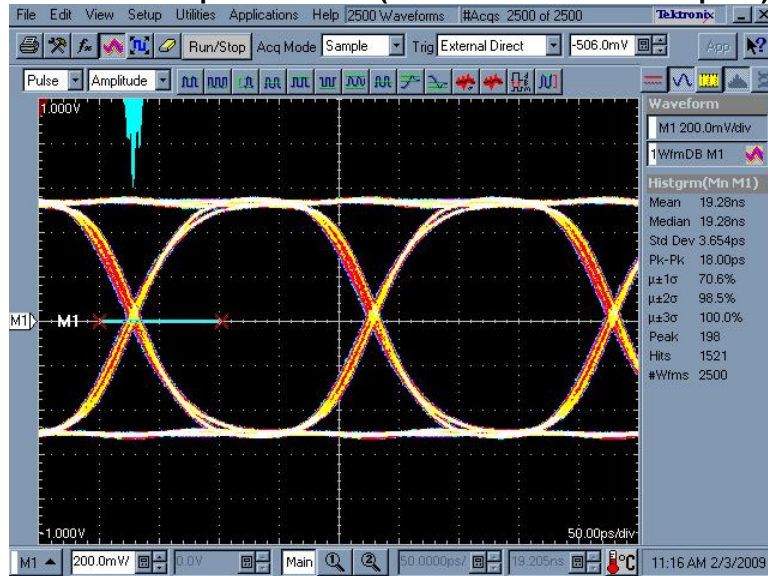

DS50PCI401 Setup condition:

Input Data: PRBS7

EQ[1:0] = F0 (11.4 dB at 2.5 GHz)

DEM[1:0] = 00 (0 dB with VOD = 1.0 Vp-p)





## DS50PCI401 Equalization Performance at 5.0 Gbps:

### Recovered Output – 30" FR4 (100 Ohm Differential Stripline)

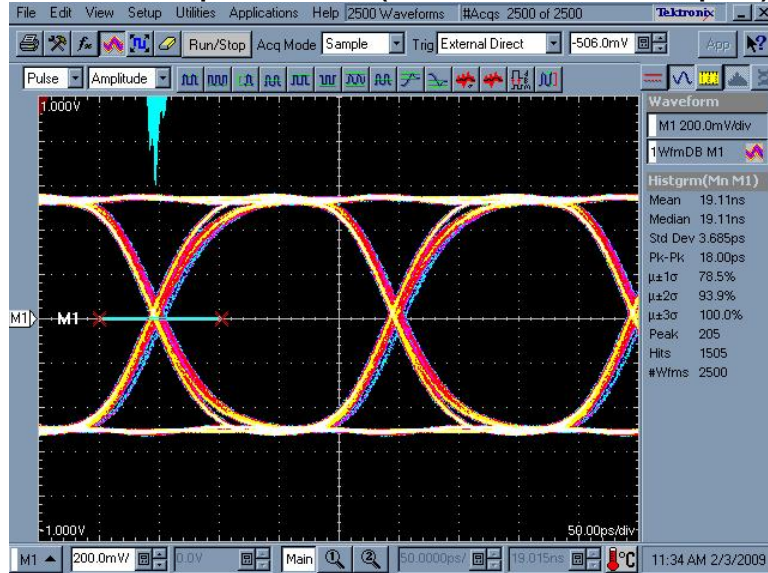

DS50PCI401 Setup condition:

Input Data: PRBS7

EQ[1:0] = 10 (15.5 dB at 2.5 GHz)

DEM[1:0] = 00 (0 dB with VOD = 1.0 Vp-p)

### Recovered Output – 40" FR4 (100 Ohm Differential Stripline)

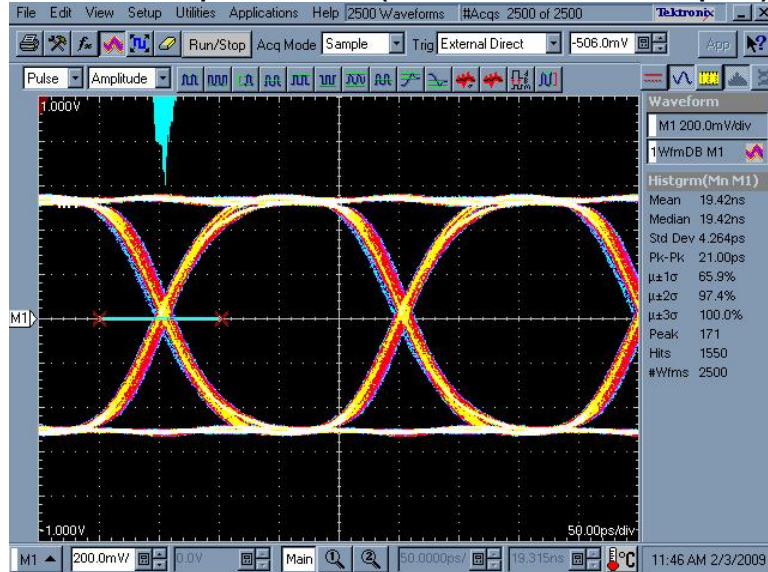

DS50PCI401 Setup condition:

Input Data: PRBS7

EQ[1:0] = F1 (17.0 dB at 2.5 GHz)

DEM[1:0] = 00 (0 dB with VOD = 1.0 Vp-p)



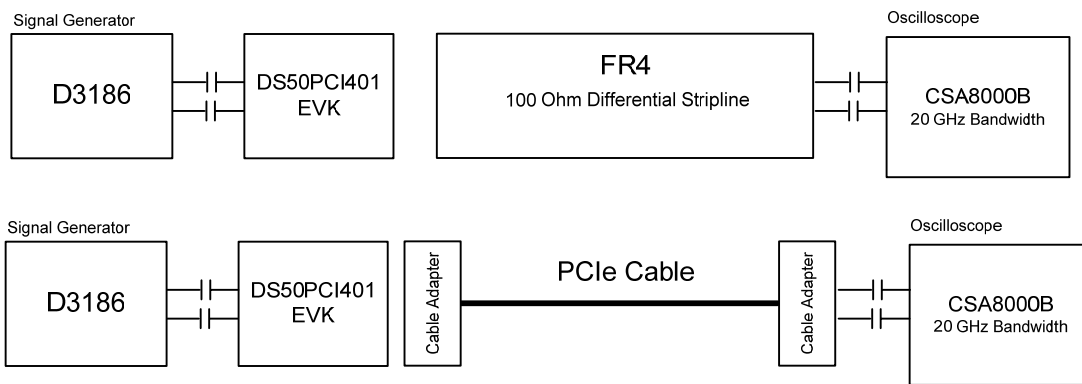
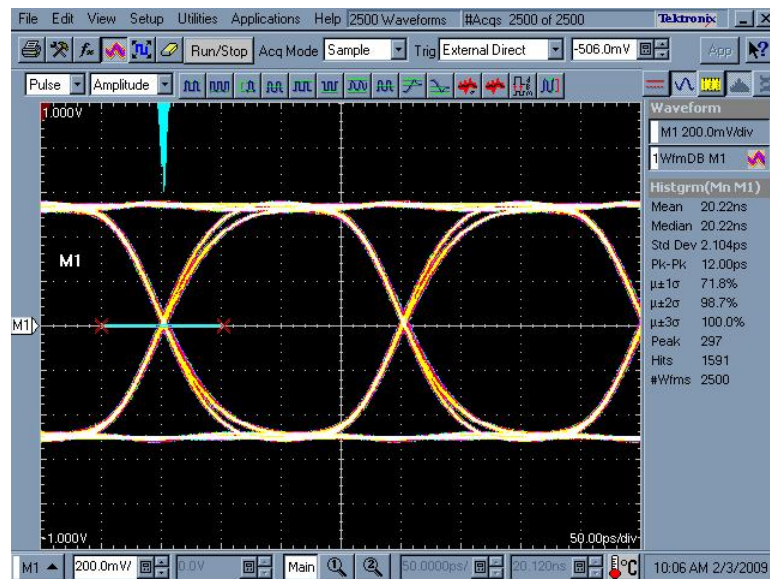

Figure 4. DS50PCI401EVK De-Emphasis Test Setup

## Typical Results:

### DS50PCI401 Device Performance with 3" EVK trace at 5.0 Gbps: OUTPUT (EVK Trace Only)



DS50PCI401 Setup condition:  
 Input Data: PRBS7  
 EQ[1:0] = FF (Bypass or Off)  
 DEM[1:0] = 00 (-0 dB with VOD = 1.0 Vp-p)

## DS50PCI401 De-Emphasis Performance at 5.0 Gbps:

### Output after 20" FR4 (100 Ohm Differential Stripline)

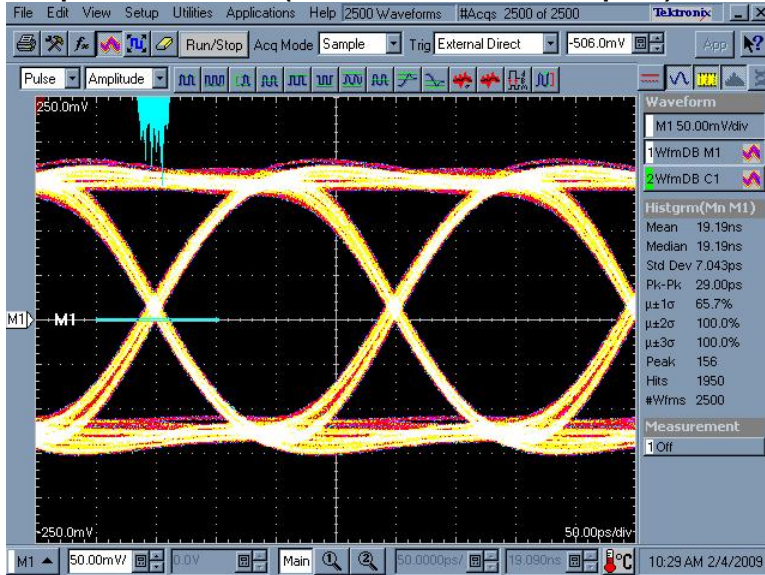

DS50PCI401 Setup condition:

Input Data: PRBS7

EQ[1:0] = FF (Bypass or Off)

DEM[1:0] = 11 (-6 dB enhanced)

### Output after 30" FR4 (100 Ohm Differential Stripline)

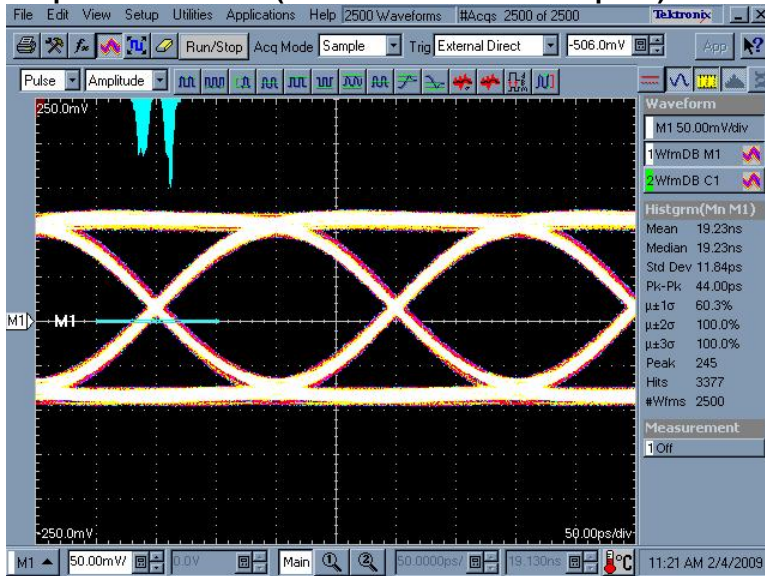

DS50PCI401 Setup condition:

Input Data: PRBS7

EQ[1:0] = FF (Bypass or Off)

DEM[1:0] = 0F (-9 dB enhanced)



## DS50PCI401 De-Emphasis Performance at 5.0 Gbps:

### Output after 40" FR4 (100 Ohm Differential Stripline)

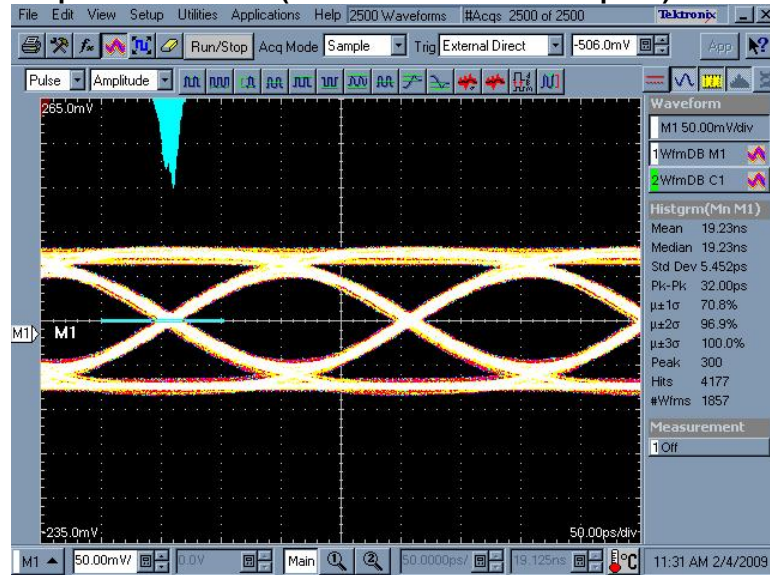

DS50PCI401 Setup condition:

Input Data: PRBS7

EQ[1:0] = FF (Bypass or Off)

DEM[1:0] = 1F (-12 dB enhanced)

Scope plots of Active - Idle through the DS50PCI401:

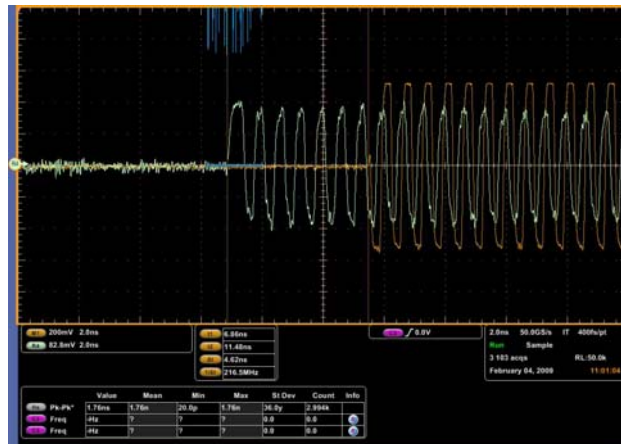

Idle to Active Response Time: ~ 4.6 ns

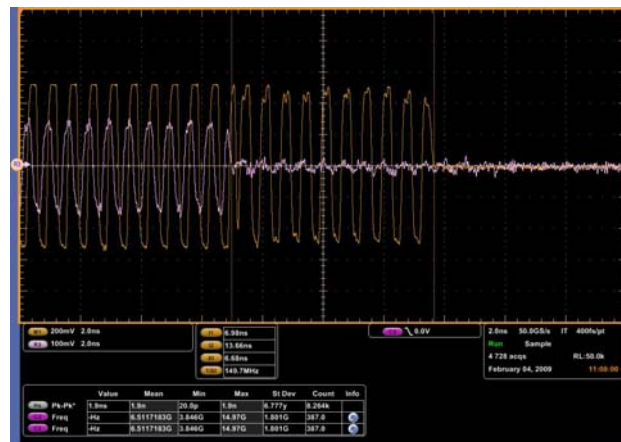

Active to Idle Response Time: ~ 6.7 ns

Figure 5. DS50PCI401EVK Active – Idle Response

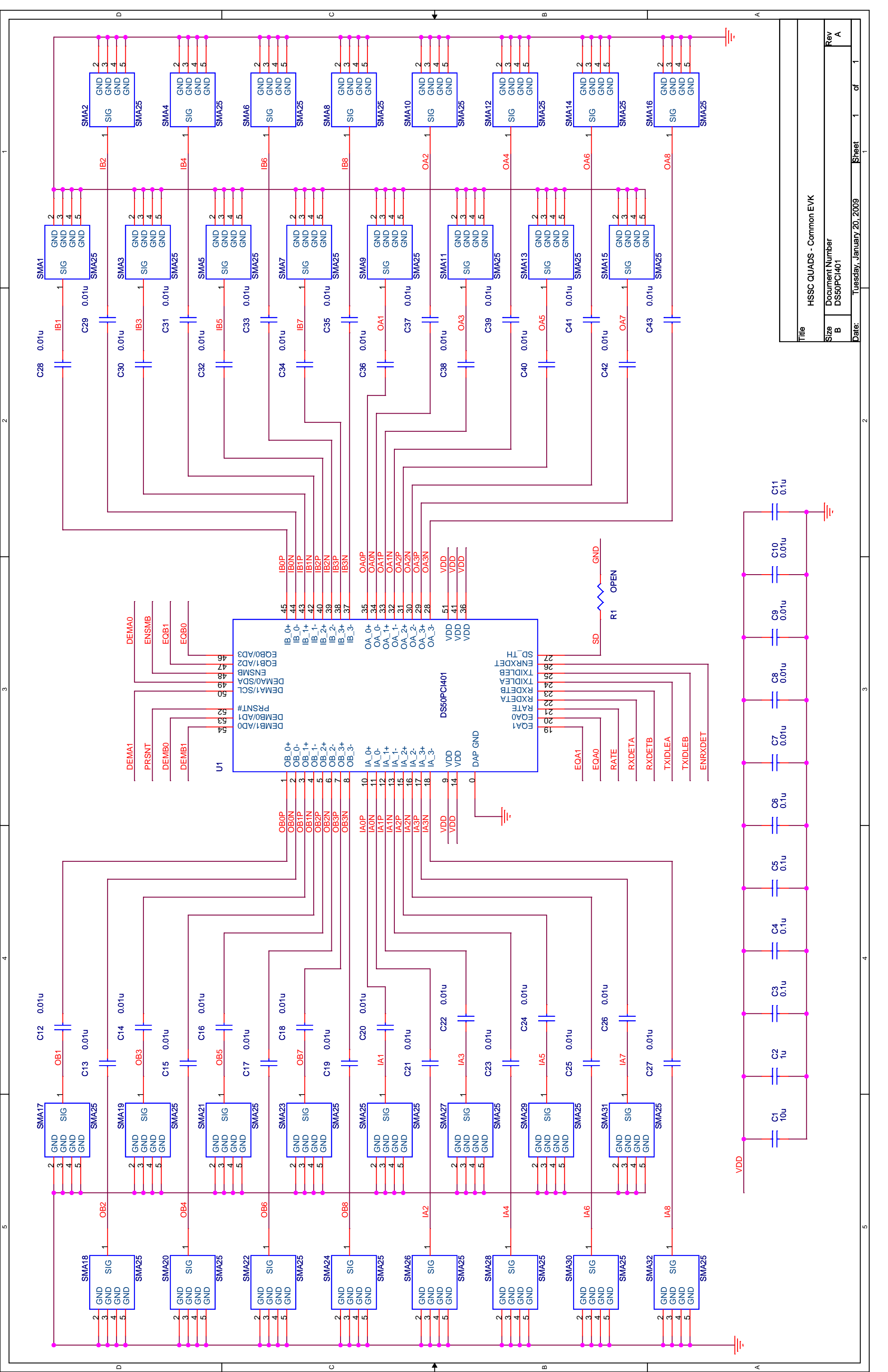

Title		HSSC QUADS - Common EVK	
Size	B	Document Number	DS50PC1401
Date:	Tuesday, January 20, 2009	Sheet	1 of 1
Rev	A		

CONNECTOR

DS50PCI401

- DEMB1
- DEMB0
- PRSDN
- DEMA1
- DEMA0
- ENSMB
- EQB1
- EQB0
- EQA1
- EQA0
- RATE
- RXDETA
- RXDETB
- TXIDLEA
- TXIDLEB
- ENRXDET

DS64BR401

- DEMB1
- DEMB0
- PWDN
- DEMA1
- DEMA0
- ENSMB
- EQB1
- EQB0
- EQA1
- EQA0
- RATE
- VOD0
- VOD1
- TXIDLEA
- TXIDLEB
- NC

- J1
- J2
- J3
- J4
- J5
- J6
- J7
- J8
- J9
- J10
- J11
- J12
- J13
- J14
- J15
- J16

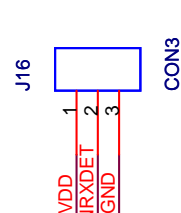
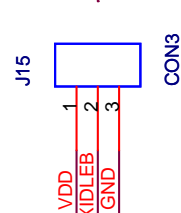
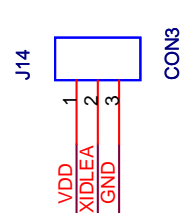
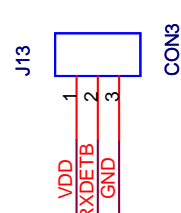
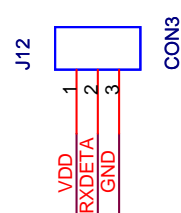
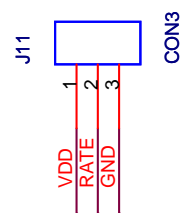
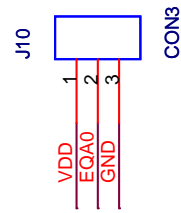
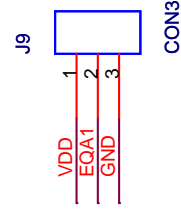
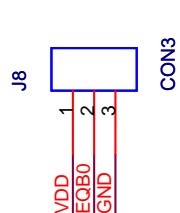
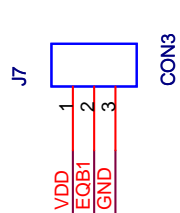
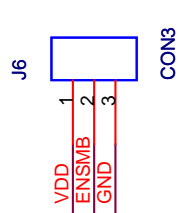
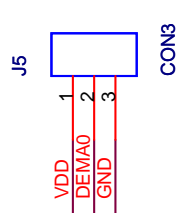
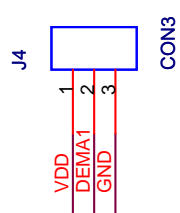
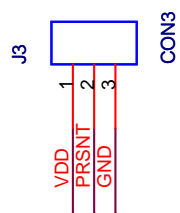
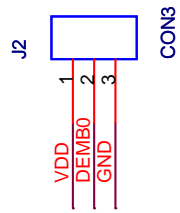
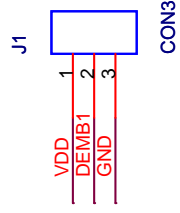

NOTE: Connector signal net names reference the DS50PCI401 design, but connections are common to all 4 EVK designs.

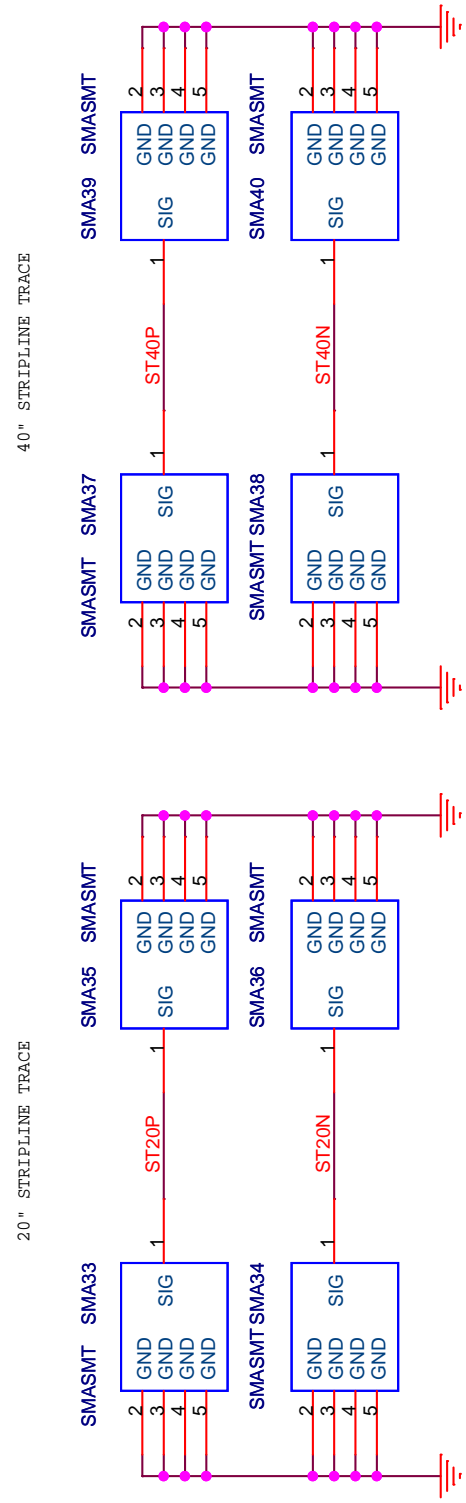

20" STRIPLINE TRACE

40" STRIPLINE TRACE

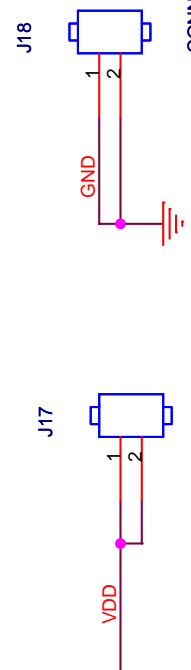

CONN PWR 2-P

CONN PWR 2-P

Title		HSSC QUADS - Common EVK	
Size	B	Document Number	COMMON
Date:	Wednesday, February 11, 2009	Sheet	1 of 1
Rev	A		

**Bill of Materials:**

DS50PCI401EVK  
 Bill of Materials  
 February 26, 2009

Interface Applications

Rev. A

Item	Quantity	Reference	Part	Source
1	1	C1	10u	PCC2420CT-ND
2	1	C2	1u	PCC2257CT-ND
3	5	C3, C4, C5, C6, C11	0.1u	PCC13490CT-ND
4	4	C7, C8, C9, C10	0.01u	PCC2270CT-ND
5	16	J1, J2, J3, J4, J5, J6, J7, J8, J9 J10, J11, J12, J13, J14, J15, J16	CON3	WM6103-ND
6	2	J17, J18	CON2P	Keystone 1287-ST
7	32	SMA1, SMA2, SMA3, SMA4, SMA5, SMA6, SMA7, SMA8, SMA9, SMA10, SMA11, SMA12, SMA13, SMA14, SMA15, SMA16, SMA17, SMA18, SMA19, SMA20, SMA21, SMA22, SMA23, SMA24, SMA25, SMA26, SMA27, SMA28, SMA29, SMA30, SMA31, SMA32	SMA25	142-0701-821
8	8	SMA33, SMA34, SMA35, SMA36, SMA37, SMA38, SMA39, SMA40	SMASMT	142-0711-201
9	1	U1	DS50PCI401	NSC
10	1	R1	Do Not Stuff	
11	32	C12, C13, C14, C15, C16, C17, C18, C19, C20, C21, C22, C23, C24, C25, C26, C27, C28, C29, C30, C31, C32, C33, C34, C35, C36, C37, C38, C39, C40, C41, C42, C43	Do Not Stuff	





## FAB/Manufacture Information:

The major fabrication highlights are listed below.

1. Utilize Nelco N4000-13EP for high speed signals.
2. Optimized SMA launch structure for Johnson edge launch connector.
3. Utilize a coplanar waveguide structure for reduced loss and enhanced metal coverage.

**Material:** Nelco N4000-13EP – ROHS compliant

### Layer Stack Up:

1/2 oz. ----- TOP  
5.8 mils (Nelco)  
1/2 oz. -----GND  
10 mils  
1/2 oz. ----- SIG  
8 mils  
1/2 oz. -----GND  
3 mils  
1/2 oz. -----VDD  
8 mils  
1/2 oz. ----- SIG  
10 mils  
1/2 oz. -----GND – Back Drill past this layer  
5.8 mils  
1/2 oz. ----- BOT

**Overall Thickness:** 0.062" ± 0.004"

Adjust metal thickness on inner plane layers to meet overall thickness

### Transmission Line Characteristics:

The TOP layer 50-ohm signals will be based on Figures 6 and 7 below. This shows a microstrip with a Width = 11 mil, Dielectric Height = 5.8 mil, Final Copper Thickness = 2.4 mil, and a Dielectric Constant = 3.2. The TOP layer 100-ohm signals will be based on Figure 8 on the following page. This shows an edge coupled differential microstrip with a Width = 7 mil, Dielectric Height = 5.8 mil, Finished Copper Thickness = 2.4 mil, Spacing = 8 mil, and a Dielectric Constant = 3.2.

### Impedance Geometries:

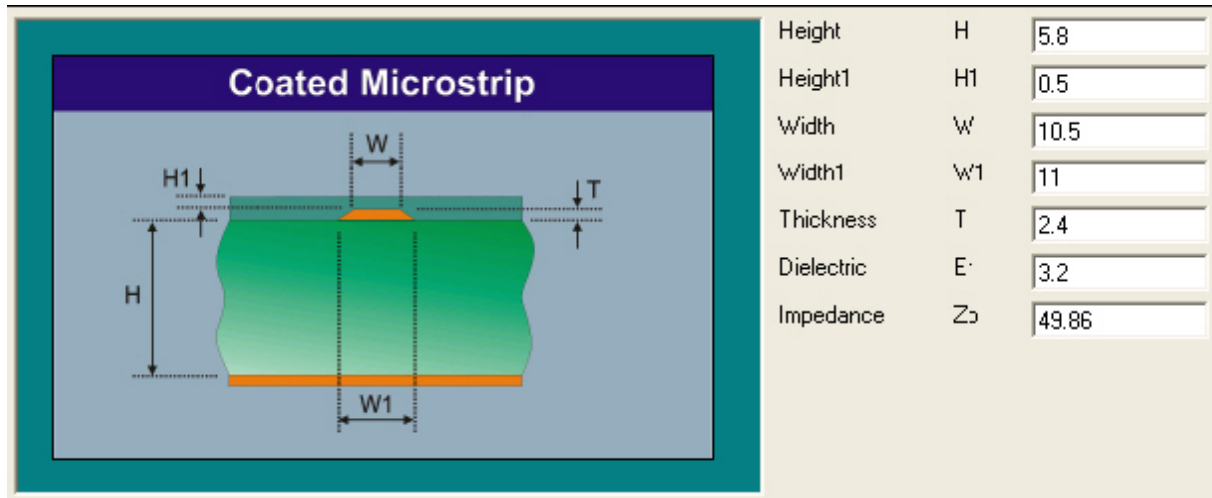

Figure 6. DS50PCI401EVK 50 Ohm Microstrip

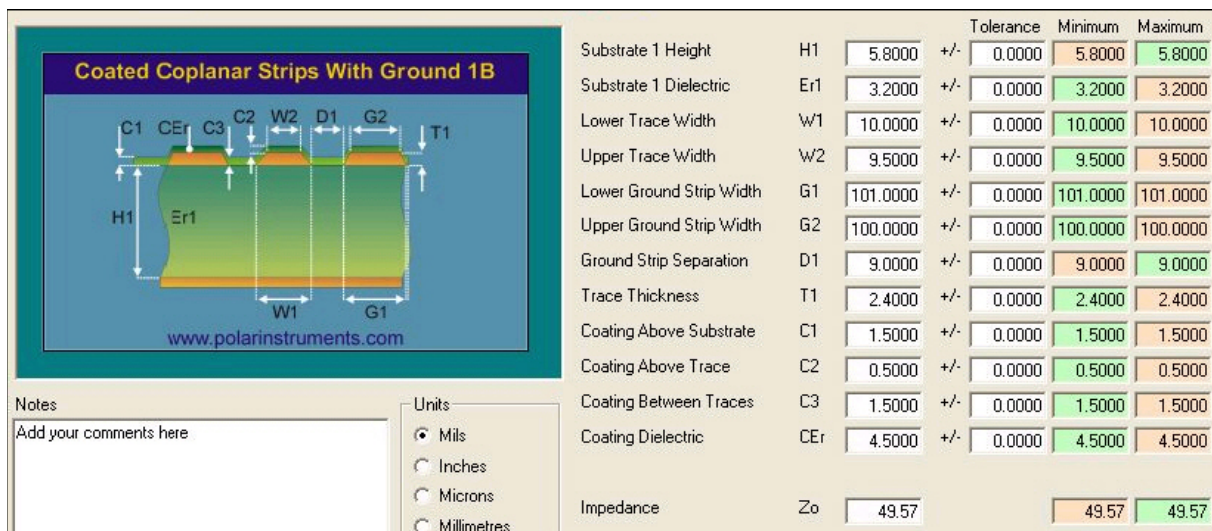

Figure 7. DS50PCI401EVK 50 Ohm Waveguide

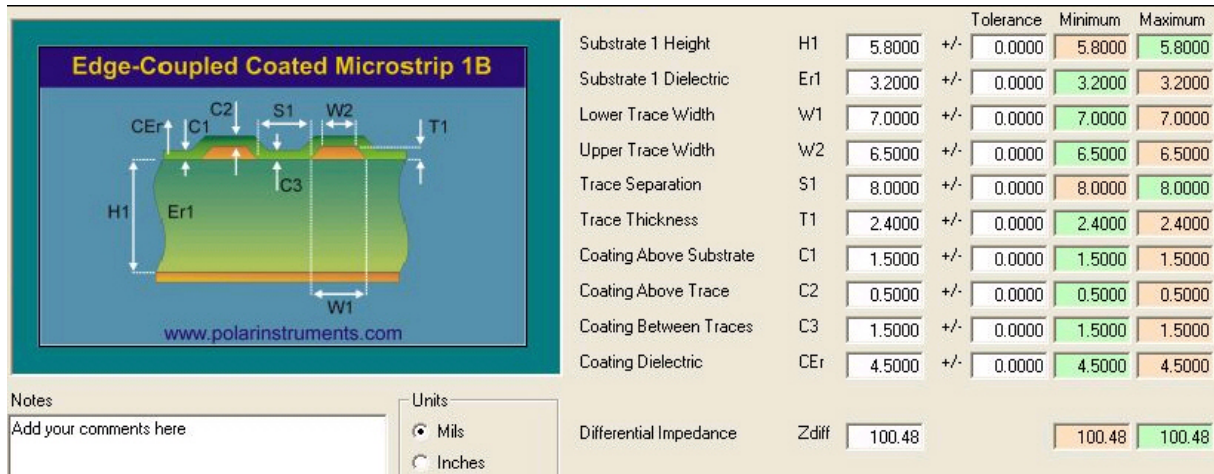

Figure 8. DS50PCI401EVK 100 Ohm Differential Microstrip

---

Document ID: DS50PCI401EVK User Guide  
Date: June 25, 2009  
Rev: 1.0



## IMPORTANT NOTICE

Texas Instruments Incorporated and its subsidiaries (TI) reserve the right to make corrections, modifications, enhancements, improvements, and other changes to its products and services at any time and to discontinue any product or service without notice. Customers should obtain the latest relevant information before placing orders and should verify that such information is current and complete. All products are sold subject to TI's terms and conditions of sale supplied at the time of order acknowledgment.

TI warrants performance of its hardware products to the specifications applicable at the time of sale in accordance with TI's standard warranty. Testing and other quality control techniques are used to the extent TI deems necessary to support this warranty. Except where mandated by government requirements, testing of all parameters of each product is not necessarily performed.

TI assumes no liability for applications assistance or customer product design. Customers are responsible for their products and applications using TI components. To minimize the risks associated with customer products and applications, customers should provide adequate design and operating safeguards.

TI does not warrant or represent that any license, either express or implied, is granted under any TI patent right, copyright, mask work right, or other TI intellectual property right relating to any combination, machine, or process in which TI products or services are used. Information published by TI regarding third-party products or services does not constitute a license from TI to use such products or services or a warranty or endorsement thereof. Use of such information may require a license from a third party under the patents or other intellectual property of the third party, or a license from TI under the patents or other intellectual property of TI.

Reproduction of TI information in TI data books or data sheets is permissible only if reproduction is without alteration and is accompanied by all associated warranties, conditions, limitations, and notices. Reproduction of this information with alteration is an unfair and deceptive business practice. TI is not responsible or liable for such altered documentation. Information of third parties may be subject to additional restrictions.

Resale of TI products or services with statements different from or beyond the parameters stated by TI for that product or service voids all express and any implied warranties for the associated TI product or service and is an unfair and deceptive business practice. TI is not responsible or liable for any such statements.

TI products are not authorized for use in safety-critical applications (such as life support) where a failure of the TI product would reasonably be expected to cause severe personal injury or death, unless officers of the parties have executed an agreement specifically governing such use. Buyers represent that they have all necessary expertise in the safety and regulatory ramifications of their applications, and acknowledge and agree that they are solely responsible for all legal, regulatory and safety-related requirements concerning their products and any use of TI products in such safety-critical applications, notwithstanding any applications-related information or support that may be provided by TI. Further, Buyers must fully indemnify TI and its representatives against any damages arising out of the use of TI products in such safety-critical applications.

TI products are neither designed nor intended for use in military/aerospace applications or environments unless the TI products are specifically designated by TI as military-grade or "enhanced plastic." Only products designated by TI as military-grade meet military specifications. Buyers acknowledge and agree that any such use of TI products which TI has not designated as military-grade is solely at the Buyer's risk, and that they are solely responsible for compliance with all legal and regulatory requirements in connection with such use.

TI products are neither designed nor intended for use in automotive applications or environments unless the specific TI products are designated by TI as compliant with ISO/TS 16949 requirements. Buyers acknowledge and agree that, if they use any non-designated products in automotive applications, TI will not be responsible for any failure to meet such requirements.

Following are URLs where you can obtain information on other Texas Instruments products and application solutions:

### Products

Audio	<a href="http://www.ti.com/audio">www.ti.com/audio</a>
Amplifiers	<a href="http://amplifier.ti.com">amplifier.ti.com</a>
Data Converters	<a href="http://dataconverter.ti.com">dataconverter.ti.com</a>
DLP® Products	<a href="http://www.dlp.com">www.dlp.com</a>
DSP	<a href="http://dsp.ti.com">dsp.ti.com</a>
Clocks and Timers	<a href="http://www.ti.com/clocks">www.ti.com/clocks</a>
Interface	<a href="http://interface.ti.com">interface.ti.com</a>
Logic	<a href="http://logic.ti.com">logic.ti.com</a>
Power Mgmt	<a href="http://power.ti.com">power.ti.com</a>
Microcontrollers	<a href="http://microcontroller.ti.com">microcontroller.ti.com</a>
RFID	<a href="http://www.ti-rfid.com">www.ti-rfid.com</a>
OMAP Mobile Processors	<a href="http://www.ti.com/omap">www.ti.com/omap</a>
Wireless Connectivity	<a href="http://www.ti.com/wirelessconnectivity">www.ti.com/wirelessconnectivity</a>

### Applications

Automotive and Transportation	<a href="http://www.ti.com/automotive">www.ti.com/automotive</a>
Communications and Telecom	<a href="http://www.ti.com/communications">www.ti.com/communications</a>
Computers and Peripherals	<a href="http://www.ti.com/computers">www.ti.com/computers</a>
Consumer Electronics	<a href="http://www.ti.com/consumer-apps">www.ti.com/consumer-apps</a>
Energy and Lighting	<a href="http://www.ti.com/energy">www.ti.com/energy</a>
Industrial	<a href="http://www.ti.com/industrial">www.ti.com/industrial</a>
Medical	<a href="http://www.ti.com/medical">www.ti.com/medical</a>
Security	<a href="http://www.ti.com/security">www.ti.com/security</a>
Space, Avionics and Defense	<a href="http://www.ti.com/space-avionics-defense">www.ti.com/space-avionics-defense</a>
Video and Imaging	<a href="http://www.ti.com/video">www.ti.com/video</a>

TI E2E Community Home Page

[e2e.ti.com](http://e2e.ti.com)

Mailing Address: Texas Instruments, Post Office Box 655303, Dallas, Texas 75265  
Copyright © 2012, Texas Instruments Incorporated