

DS90UB924-Q1EVM

User's Guide



Literature Number: SNLU208
April 2016

1	DS90UB924-Q1EVM User's Guide	5
1.1	General Description	5
1.2	Features.....	5
1.3	System Requirements	6
1.4	Contents of the Demo Evaluation Kit	6
1.5	Applications Diagram.....	6
1.6	Typical Configuration	7
1.7	Quick Start Guide	8
1.8	Default Jumper Settings	9
1.9	Default Switch Settings	9
1.10	Demo Board Connections.....	10
1.11	ALP Software Setup	12
1.11.1	System Requirements	12
1.11.2	Download Contents	12
1.11.3	Installation of the ALP Software	12
1.11.4	Startup - Software Description.....	13
1.11.5	Information Tab.....	16
1.11.6	Pattern Generator Tab.....	17
1.11.7	Registers Tab.....	18
1.11.8	Registers Tab - Address 0x00 selected	19
1.11.9	Scripting Tab.....	21
1.12	Troubleshooting ALP Software	22
1.12.1	ALP Loads the Incorrect Profile	22
1.12.2	ALP does not detect the EVM	24
1.13	Typical Connection and Test Equipment.....	26
1.14	Equipment References	27
1.15	Cable References	27
2	Bill of Materials	28
A	EVM PCB Schematics	30
A.1	Board Stackup	31
A.2	DS90UB924-Q1 Deserializer	32
A.3	USB-to-I2C Controller	33
A.4	Power	34
B	Board Layout	35
B.1	Board Layers.....	35

List of Figures

1-1.	Applications Diagram	6
1-2.	Typical Configuration	7
1-3.	Interfacing to the EVM	8
1-4.	Launching ALP	13
1-5.	Initial ALP Screen	14
1-6.	Follow-up Screen	15
1-7.	ALP Information Tab	16
1-8.	ALP Pattern Generator Tab	17
1-9.	ALP Registers Tab	18
1-10.	ALP Device ID Selected	19
1-11.	ALP Scripting Tab	21
1-12.	USB2ANY Setup	22
1-13.	Remove Incorrect Profile	22
1-14.	Add Correct Profile	23
1-15.	ALP No Devices Error	24
1-16.	Windows 7, ALP USB Driver	24
1-17.	ALP in Demo Mode	25
1-18.	ALP Preferences Menu	25
1-19.	Typical Test Setup for Video Application	26
1-20.	Typical Test Setup for Evaluation	26
A-1.	Board Stackup	31
A-2.	Deserializer	32
A-3.	USB-to-I2C Controller	33
A-4.	Power	34
1	Top Silkscreen	35
2	Top Solder Mask	35
3	Top Copper	35
4	Internal Layer 1: Ground	35
5	Internal Layer 2: Power	35
6	Bottom Copper	35
7	Bottom Solder Mask	37
8	Bottom Silkscreen	37
9	Drill	37

List of Tables

1-1.	Default Board Jumper Settings	9
1-2.	Default Board Switch Settings	9
1-3.	Power Supply	10
1-4.	USB2ANY Connector	10
1-5.	I2C Interface Header	10
1-6.	MODE SELECTION INPUTS (S1)	10
1-7.	IDx Settings (S2 and S3)	10
1-8.	OUTPUT STATE SELECT (S4)	11
1-9.	MODE_SEL Settings (S5)	11
2-1.	Bill of Materials	28

DS90UB924-Q1EVM User's Guide

1.1 General Description

The DS90UB924-Q1EVM (Evaluation Module) helps system designers evaluate the operation and performance of the DS90UB924-Q1 FPD-Link III Deserializer. The device translates a high-speed serialized FPD-Link III interface transported over a single Shielded Twisted Pair (STP) cable into four FPD-Link (OpenLDI) compatible LVDS data output pairs and on LVDS clock. The DS90UB924-Q1 is in conjunction with the DS90UB921-Q1, DS90UB925Q-Q1, DS90UB927Q-Q1, DS90UB929-Q1, DS90UB949-Q1, and DS90UB947-Q1 Serializers.

The DS90UB924-Q1EVM board features a 20-position IDC connector for connecting to the FPD-Link (OpenLDI) outputs and a HSD Automotive Connector for connecting an automotive-grade STP cable to the FPD-Link III input. The included SMA connectors may also be configured as the FPD-Link III data input, enabling evaluation of other connectors and cable configurations.

The DS90UB924-Q1 supports clocks in the range of 5 MHz to 96 MHz.

WARNING

The demo board is not intended for EMI testing. The demo board was designed for easy accessibility to device pins with tap points for monitoring or applying signals, additional pads for termination, and multiple connector options.

1.2 Features

- Qualified for Automotive Applications AEC-Q100
 - Device Temperature Grade 2: -40°C to +105°C Ambient Operating Temperature Range
 - Device HBM ESD Classification Level ± 8 kV
 - Device CDM ESD Classification Level C6
- 5 MHz to 96 MHz Pixel Clock Support
- Bidirectional Control Channel Interface with I²C-Compatible Serial Control Bus
- Low EMI FPD-Link (OpenLDI) Video Output
- Supports High Definition (720p) Digital Video
- RGB888 + VS, HS, DE and I2S Audio Supported
- Up to 4 I2S Digital Audio Outputs for Surround Sound Applications
- 4 Bidirectional GPIO Channels With 2 Dedicated Pins
- Single 3.3 V supply with 1.8 V or 3.3 V Compatible LVCMOS I/O Interface
- AC-Coupled STP Interconnect Up to 10 Meters
- DC-Balanced and Scrambled Data with Embedded Clock
- Adaptive Cable Equalization
- Internal Pattern Generation
- Backward Compatible Modes

1.3 System Requirements

In order to demonstrate, the following is required:

1. FPD-Link III compatible serializer
 - (a) DS90UB921-Q1, DS90UB929-Q1, DS90UB949-Q1, and DS90UB947-Q1 up to 96MHz
 - (b) DS90UB925Q-Q1 and DS90UB927Q-Q1 up to 85MHz
2. Optional I²C controller
3. Power supply for 3.3 V or 5 V @ 1 A

1.4 Contents of the Demo Evaluation Kit

1. One EVM board with the DS90UB924-Q1
2. USB Cable

1.5 Applications Diagram

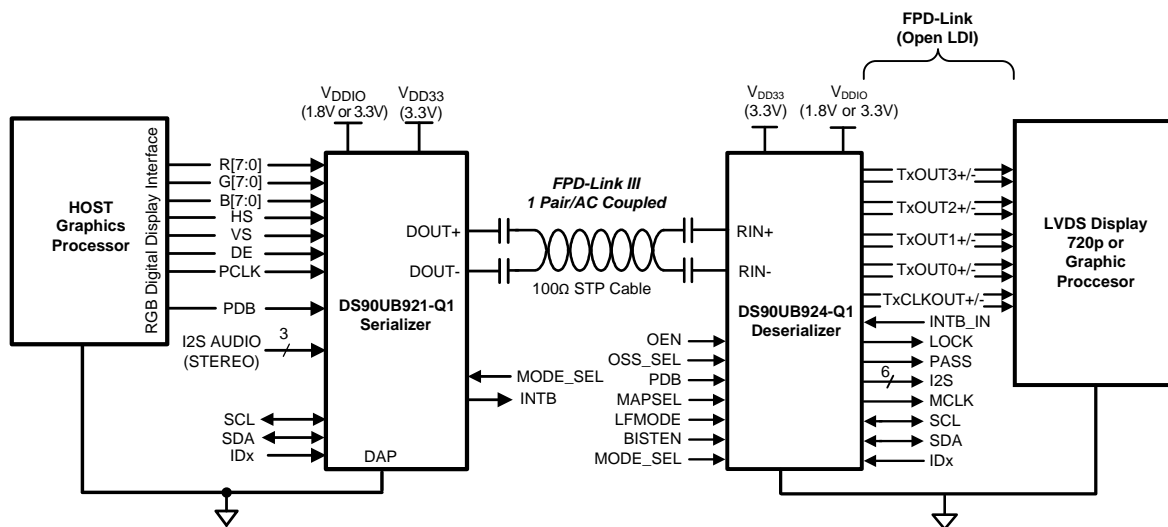

Copyright © 2016, Texas Instruments Incorporated

Figure 1-1. Applications Diagram

1.6 Typical Configuration

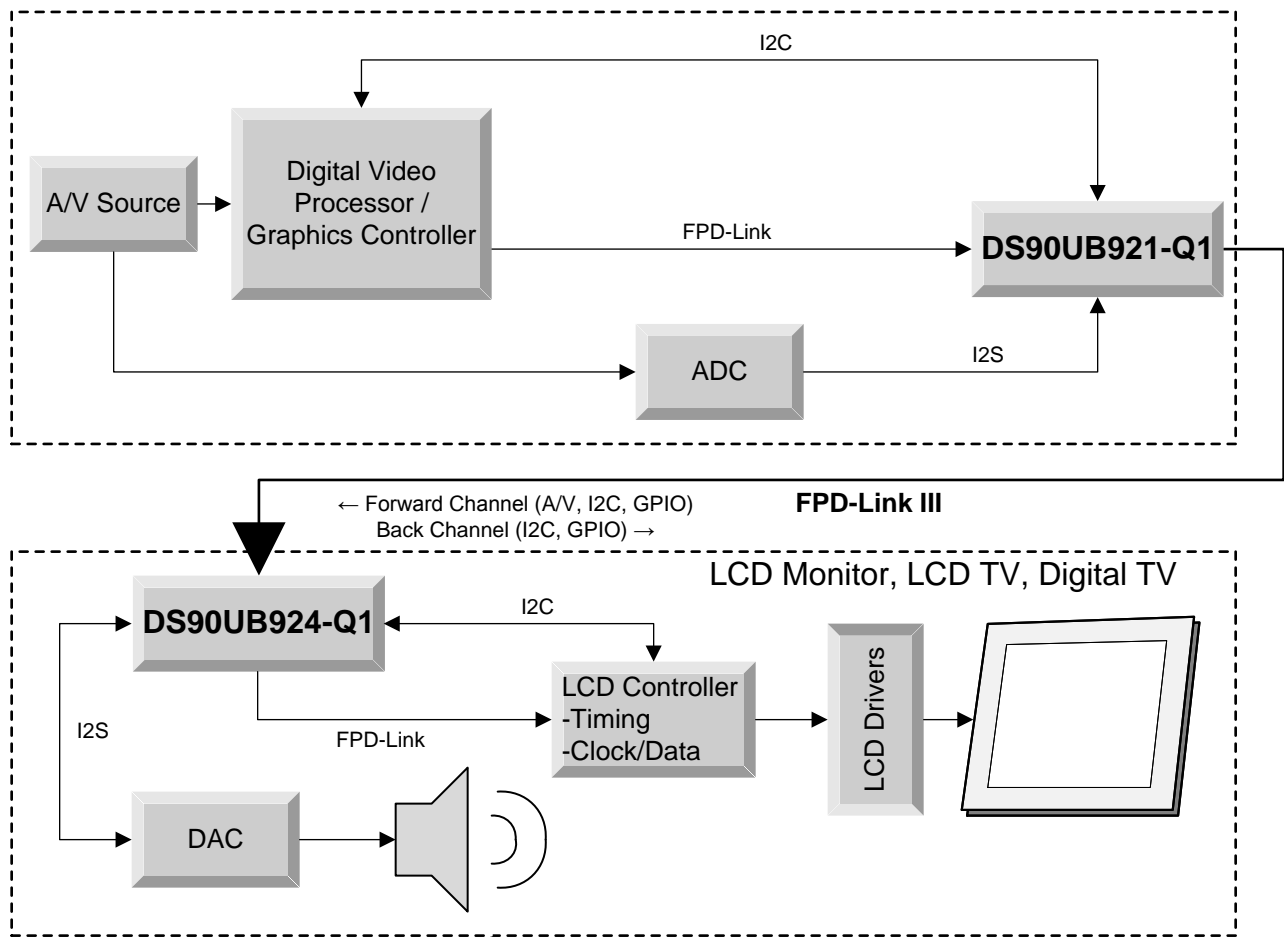

Copyright © 2016, Texas Instruments Incorporated

Figure 1-2. Typical Configuration

Figure 1-1 and Figure 1-2 illustrate the use of the chipset in a display application.

1.7 Quick Start Guide

1. The DS90UB924-Q1EVM is configured for the differential operation by using STP cable.
2. Connect J4 to compatible Serializer e.g. DS90UB921-Q1, DS90UB925Q-Q1, DS90UB927Q-Q1, DS90UB929-Q1, DS90UB949-Q1, and DS90UB947-Q1.
3. Configure switches S2, S3 and S5 to set I²C address (IDx) and the device configuration select (MODE_SEL).
 - S2 and S3: IDx = 0x58 (default factory setting)
 - S5: MODE_SEL = 1 (default factory setting)
4. Connect J8 to 3.3 V and J9 to GND.
 - (a) Optional power options available, J7, 5 V (see [Table 1-3](#))
5. Connect J6 with miniUSB cable to PC USB port

For details of pin-names and pin-functions, please refer to the DS90UB924-Q1 datasheet.

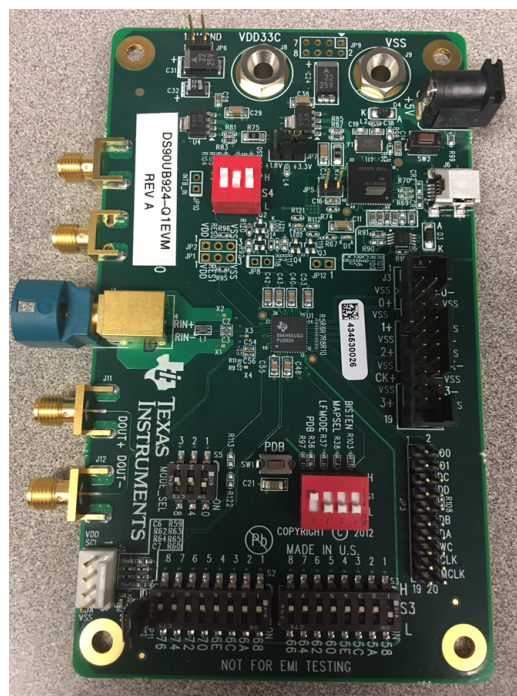

Figure 1-3. Interfacing to the EVM

1.8 Default Jumper Settings

Ensure that the board has the default board jumper settings:

Table 1-1. Default Board Jumper Settings

JUMPER	JUMPER SETTINGS
JP7	Connect jumper to select +3.3 V for VDDIO = VDD33 or +1.8 V for VDDIO = 1.8 V

1.9 Default Switch Settings

Ensure that the board has the default board switch settings:

Table 1-2. Default Board Switch Settings

SWITCH	SWITCH SETTINGS
S1	1 to 3 OFF, 4 ON
S2	1 to 8 OFF
S3	1 ON, 2 to 8 OFF
S4	1 ON, 2 OFF, 3 ON
S5	1 ON, 2 to 3 OFF

1.10 Demo Board Connections

Table 1-3. Power Supply

DESIGNATOR	SIGNAL	DESCRIPTION
J7	5 V	5 V power supply, 5 V power connector that supplies power to the entire board.
J8	3.3 V	3.3 V power supply, 3.3 V power connector that supplies power to the entire board.
J9	GND	Ground

Table 1-4. USB2ANY Connector

DESIGNATOR	DESCRIPTION
J6	mini USB 5 pin, USB Connector for USB-to-I2C Controller. Connect USB cable to host PC to use the ALP evaluation software with the EVM board.

Table 1-5. I2C Interface Header

DESIGNATOR	SIGNAL
J5.1	VDDI2C
J5.2	SCL
J5.3	SDA
J5.4	GND

Table 1-6. MODE SELECTION INPUTS (S1)

DESIGNATOR	DESCRIPTION
S1.1	BISTEN LOW: Normal operation. HIGH: Enable the Built-In Self-tet (BIST) mode.
S1.2	MAPSEL LOW: Assign LSBs to TxOUT3±. HIGH: Assign MSBs to TxOUT3±.
S1.3	LFMODE LOW: 5 MHz ≤ PCLK < 15 MHz. HIGH: 15 MHz < PCLK ≤ 96 MHz
S1.4	PDB LOW: The device enters low power mode and all register are reset. HIGH: Normal Operation.

Table 1-7. IDx Settings (S2 and S3)⁽¹⁾

DESIGNATOR	MODE #	7-Bit ADDRESS	8-Bit ADDRESS
S2.1	3	0x34	0x68
S2.2	4	0x35	0x6A
S2.3	5	0x36	0x6C
S2.4	6	0x37	0x6E
S2.5	7	0x38	0x70
S2.6	8	0x39	0x72
S2.7	9	0x3A	0x74
S2.8	10	0x3B	0x76
S3.1 (Default)	1	0x2C	0x58
S3.8	2	0x33	0x66

⁽¹⁾ Only set one high.

Table 1-8. OUTPUT STATE SELECT (S4)

DESIGNATOR	DESCRIPTION
S4.1	OEN
S4.2	BISTC / INTB_IN
S4.3	OSS_SEL

Table 1-9. MODE_SEL Settings (S5) ⁽¹⁾

DESIGNATOR	MODE #	REPEAT	BKWD	I2S-B	LCBL
S5.1 (Default)	1	L	L	L	L
S5.2	7	H	L	L	H
S5.3	9	L	H	L	L

⁽¹⁾ Only set one high.

1.11 ALP Software Setup

1.11.1 System Requirements

Operating System:	Windows 7 64-bit
USB:	USB2ANY
USB2ANY Firmware Version:	2.6.5.0

1.11.2 Download Contents

TI Analog LaunchPAD can be downloaded from: <http://www.ti.com/tool/alp>.

Download and extract the zip file to a temporary location that can be deleted later.

Make sure J6 on the DS90UB924-Q1 EVM is connected to a PC USB port with USB cable and power is applied to the DS90UB924-Q1 EVM.

The following installation instructions are for the Windows 7 64-bit Operating System.

1.11.3 Installation of the ALP Software

Execute the ALP Setup Wizard program called “ALP_setup_v_x_x_x.exe” that was extracted to a temporary location on the local drive of your PC.

There are 7 steps to the installation once the setup wizard is started:

1. Select the "Next" button.
2. Select “I accept the agreement” and then select the “Next” button.
3. Select the location to install the ALP software and then select the “Next” button.
4. Select the location for the start menu shortcut and then select the “Next” button.
5. There will then be a screen that allows the creation of a desktop icon. After selecting the desired choices select the “Next” button.
6. Select the “Install” button, and the software will then be installed to the selected location.
7. Uncheck “Launch Analog LaunchPAD” and select the “Finish” button. The ALP software will start if “Launch Analog LaunchPAD” is checked, but it will not be useful until the USB driver is installed and board is attached.

Connect J6 USB jack of the DS90UB924-Q1 EVM board to a PC/laptop USB port using a Type A

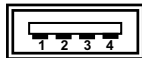

A

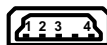

MINI

USB cable. The “Found New Hardware Wizard” will open on the PC/laptop.

1.11.4 Startup - Software Description

Make sure all the software has been installed and the hardware is powered on and connected to the PC. Execute “Analog LaunchPAD” shortcut from the start menu. The default start menu location is under All Programs > Texas Instruments > Analog LaunchPAD vx.x.x > Analog LaunchPAD to start MainGUI.exe.



Figure 1-4. Launching ALP

1.11.4.1 Initial ALP Screen

The application should come up in the state shown in [Figure 1-5](#). If it does not, see [Section 1.12](#), “Troubleshooting ALP Software”.

Under the Devices tab click on “DS90UB924” to select the device and open up the device profile and its associated tabs.

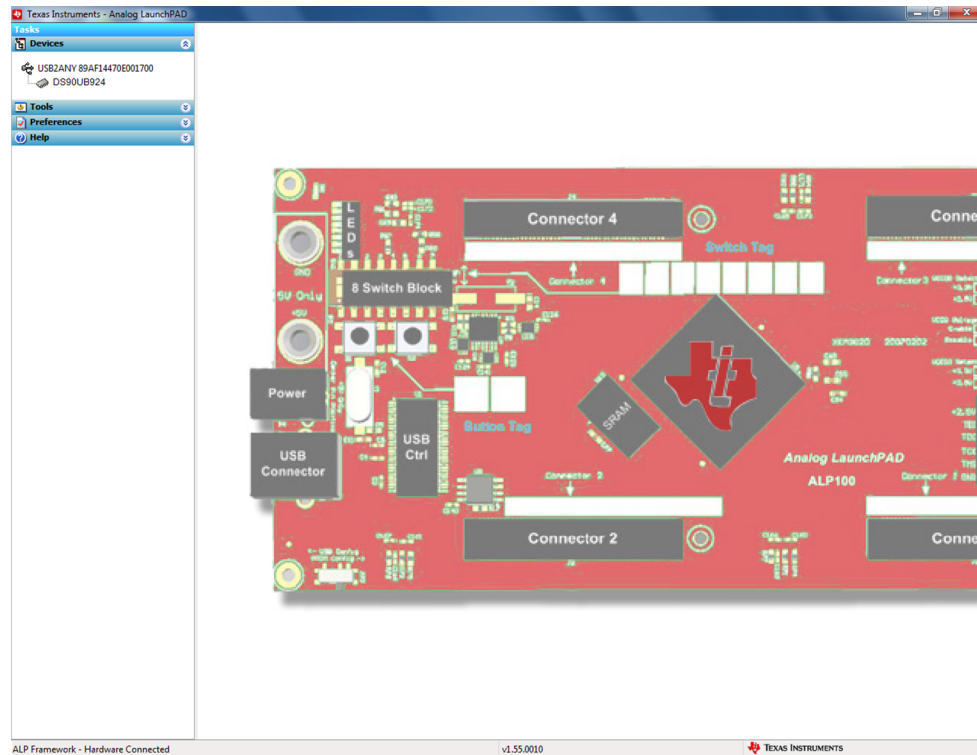

Figure 1-5. Initial ALP Screen

After selecting the DS90UB924, the following screen should appear.

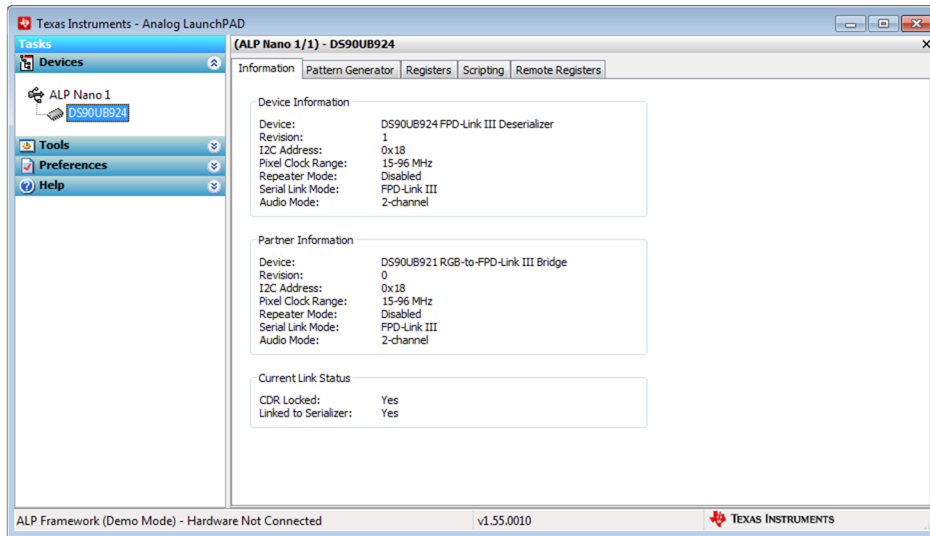

Figure 1-6. Follow-up Screen

1.11.5 Information Tab

The Information tab is shown below. Please note the device revision could be different.

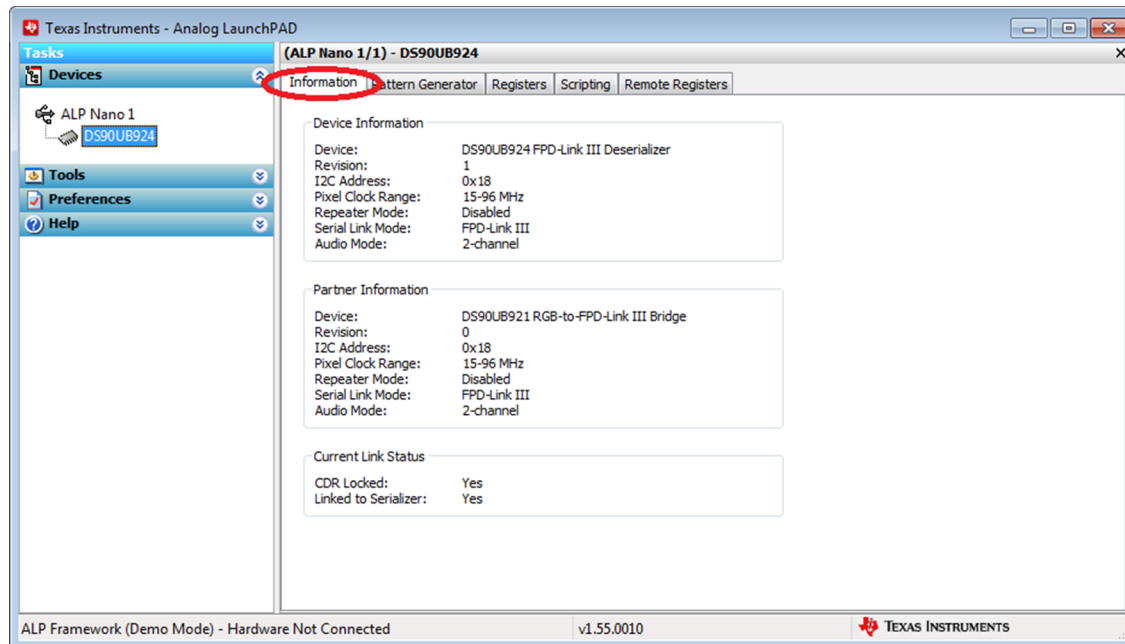

Figure 1-7. ALP Information Tab

1.11.6 Pattern Generator Tab

The Pattern Generator tab is shown below.

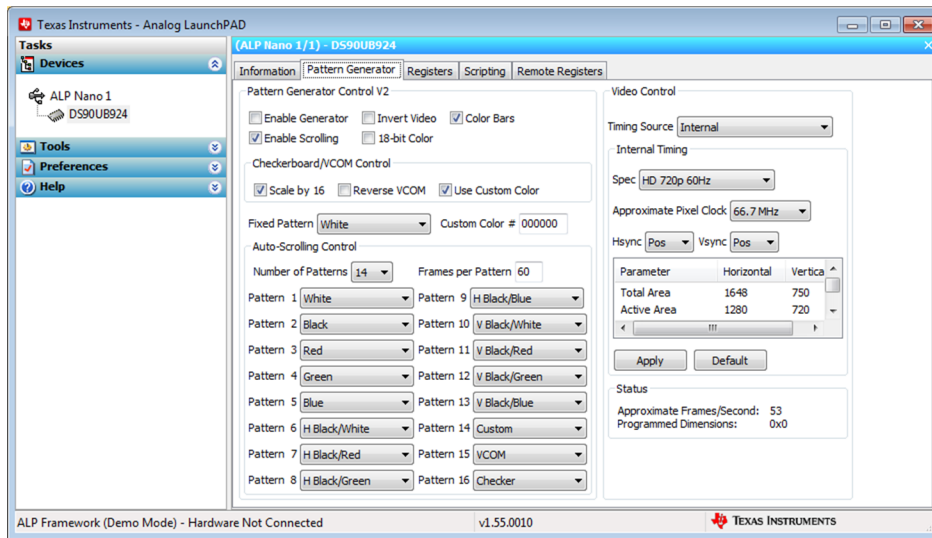

Figure 1-8. ALP Pattern Generator Tab

1.11.7 Registers Tab

The Registers tab is shown below.

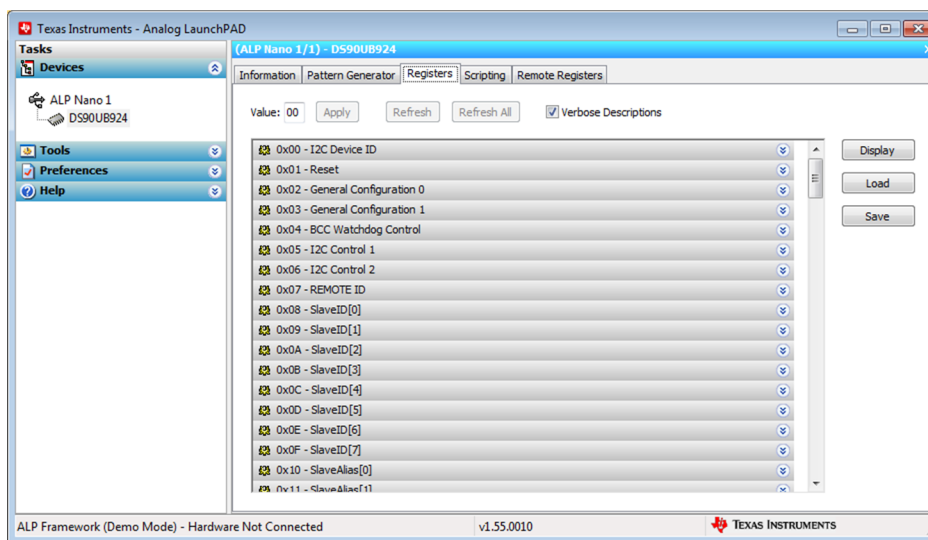

Figure 1-9. ALP Registers Tab

1.11.8 Registers Tab - Address 0x00 selected

Address 0x00 selected as shown below. Note that the “Value:” box, Value: 58, will now show the hex value of that register.

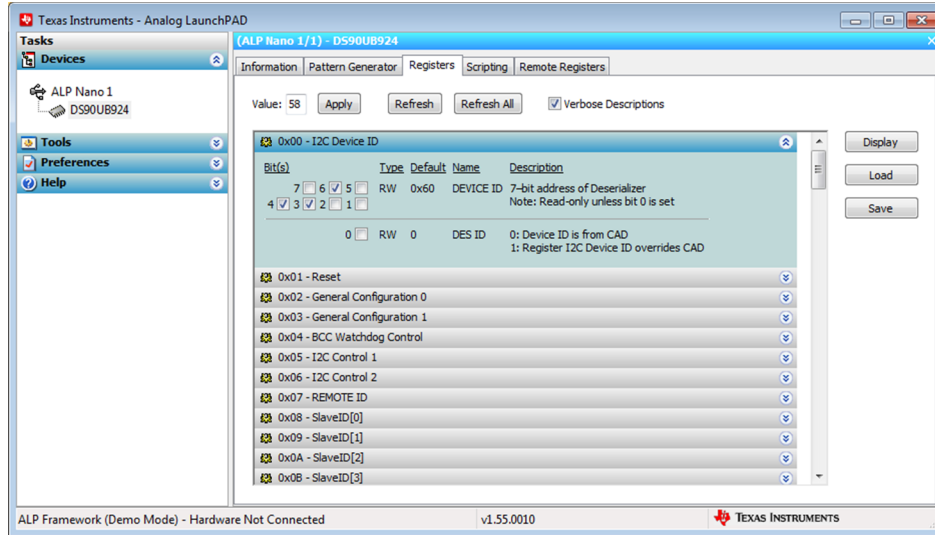





Figure 1-10. ALP Device ID Selected

By double clicking on the Address bar



or a single click on . Address 0x00 expanded reveals contents by bits. Any register address displayed can be expanded.

Any RW Type register, , can be written into by writing the hex value into the “Value:” box,  or putting the pointer into the individual register bit(s) box by a left mouse click to put a check mark (indicating a “1”) or un-checking to remove the check mark (indicating a “0”). Click the “Apply” button to write to the register, and “refresh” to see the new value of the selected (highlighted) register.



The box toggles on every mouse click.

1.11.9 Scripting Tab

The Scripting tab is shown below.

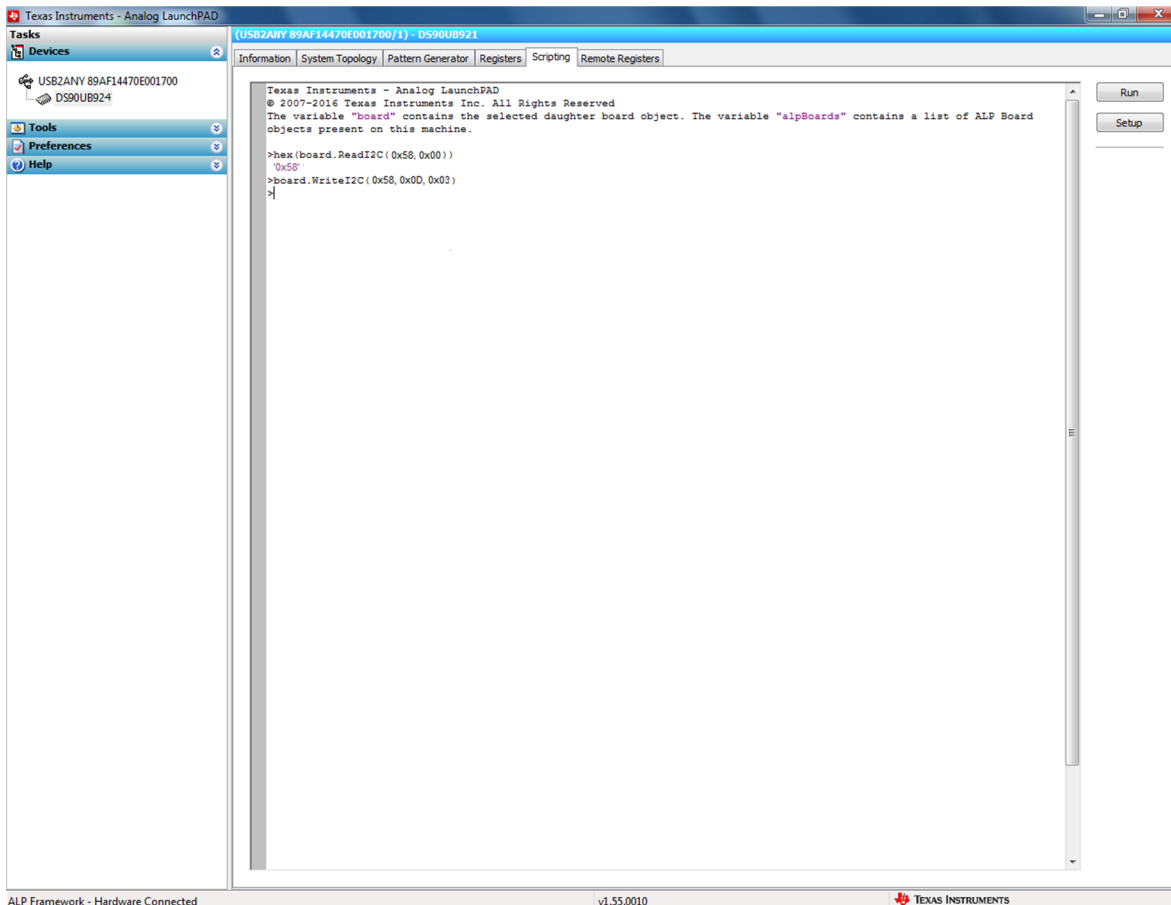

Figure 1-11. ALP Scripting Tab

The script window provides a full Python scripting environment which can be for running scripts and interacting with the device in an interactive or automated fashion.

WARNING

Directly interacting with devices either through register modifications or calling device support library functions can effect the performance and/or functionality of the user interface and may even crash the ALP Framework application.

1.12 Troubleshooting ALP Software

1.12.1 ALP Loads the Incorrect Profile

If ALP opens with the incorrect profile loaded the correct profile can be loaded from the USB2ANY/Aardvark Setup found under the tools menu.

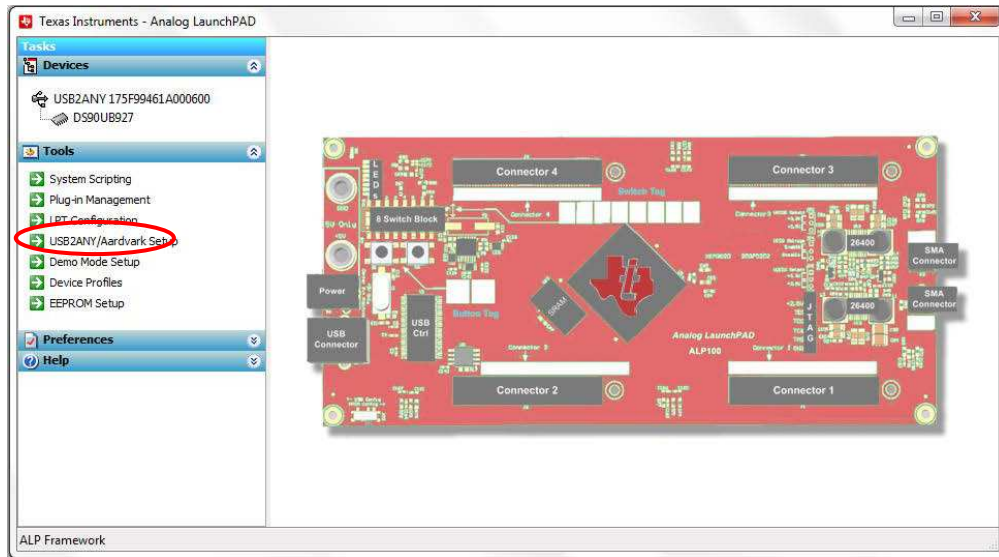

Figure 1-12. USB2ANY Setup

Highlight the incorrect profile in the Defined ALP Devices list and press the remove button.

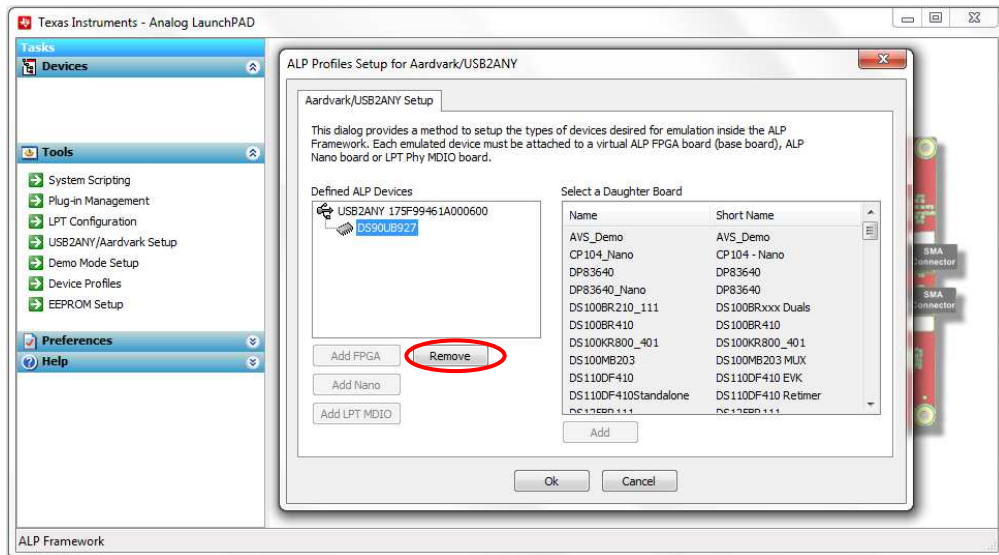

Figure 1-13. Remove Incorrect Profile

Find the correct profile under the Select a Daughter Board list, highlight the profile and press Add.

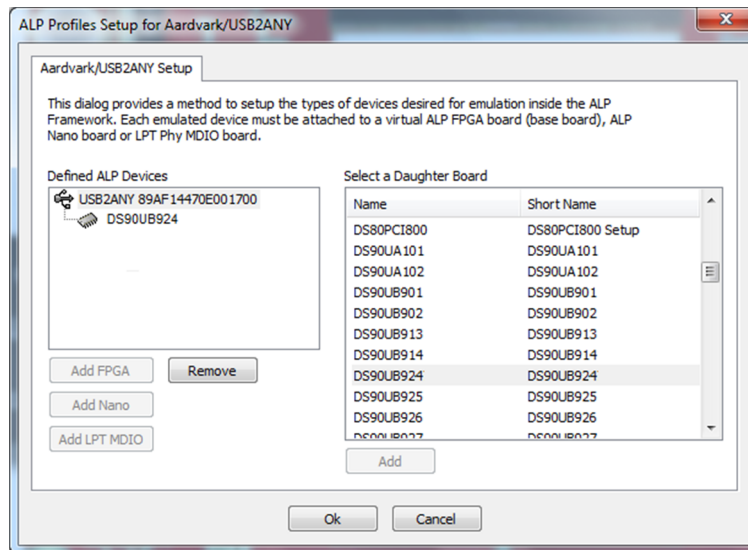

Figure 1-14. Add Correct Profile

Select Ok and the correct profile should now be loaded.

1.12.2 ALP does not detect the EVM

If the following window opens after starting the ALP software, double check the hardware setup.

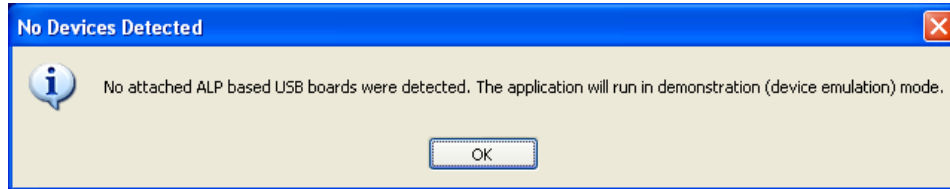

Figure 1-15. ALP No Devices Error

It may also be that the USB driver is not installed. Check the device manager. There should be a “HID-compliant device” under the “Human Interface Devices” as shown below.

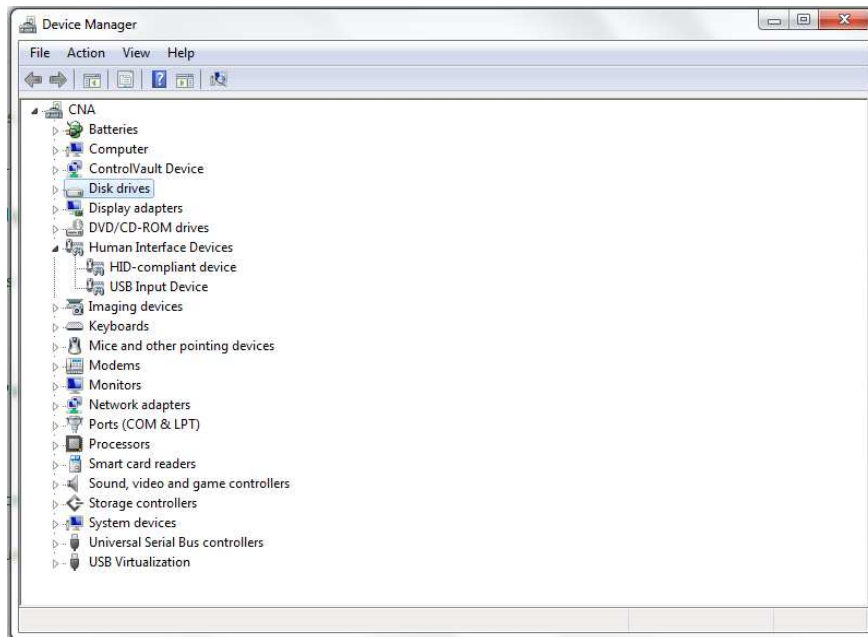

Figure 1-16. Windows 7, ALP USB Driver

The software should start with only “DS90UB924” in the “Devices” pull down menu. If there are more devices then the software is most likely in demo mode. When the ALP is operating in demo mode there is a “(Demo Mode)” indication in the lower left of the application status bar as shown below.

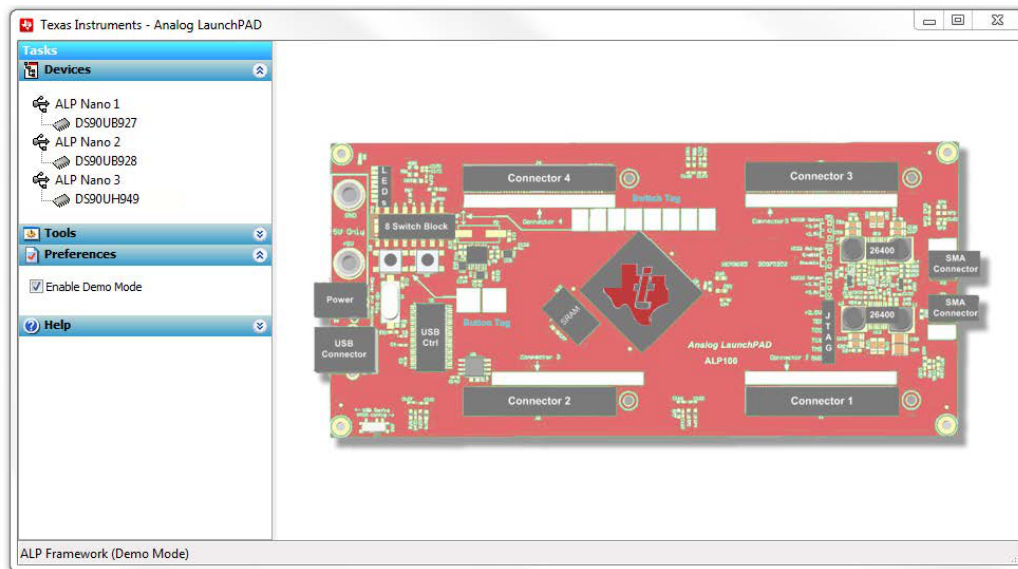

Figure 1-17. ALP in Demo Mode

Disable the demo mode by selecting the “Preferences” pull down menu and un-checking “Enable Demo Mode”.

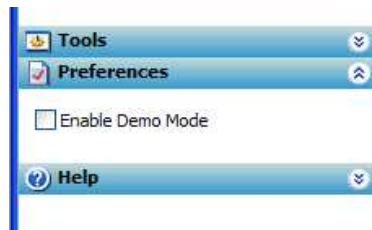

Figure 1-18. ALP Preferences Menu

After demo mode is disabled, the ALP software will poll the ALP hardware. The ALP software will update and have only “DS90UB924” under the “Devices” pull down menu.

1.13 Typical Connection and Test Equipment

The following is a list of typical test equipment that may be used to generate signals for the Serializer inputs:

1. Digital Video Source – for generation of specific display timing such as Digital Video Processor, OpenLDI or Graphics Controller (GPU).
2. Any other signal generator / video source - This video generator may be used for video signal sources.
3. Any other signal / video generator that provides the correct input levels as specified in the datasheet.

The picture below shows a typical test set up using a Graphics Controller and display.

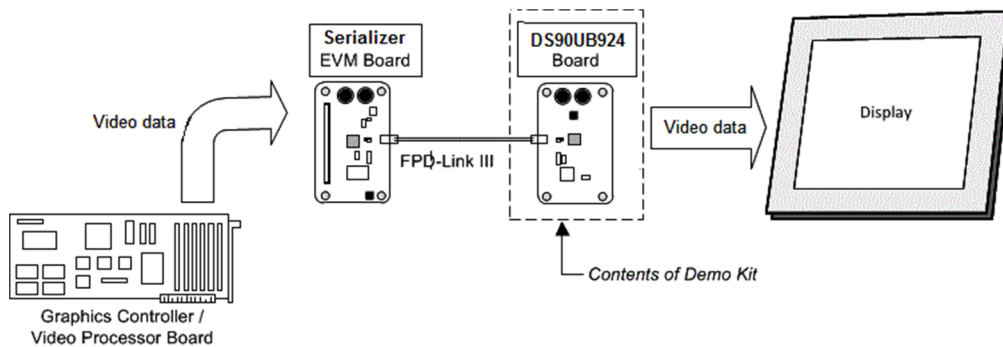

Figure 1-19. Typical Test Setup for Video Application

The picture below shows a typical test set up using a video generator and logic analyzer.

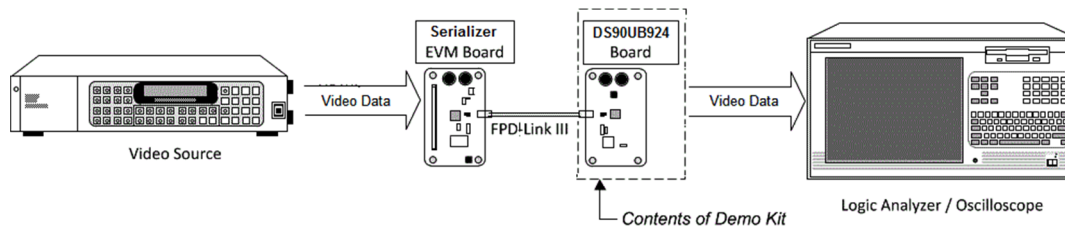

Figure 1-20. Typical Test Setup for Evaluation

1.14 Equipment References

NOTE: Please note that the following references are supplied only as a courtesy to our valued customers. It is not intended to be an endorsement of any particular equipment or supplier.

Digital Video Pattern Generator:

Astrodesign

www.astro-america.com

Logic Analyzer:

keysight Technologies

www.keysight.com

Corelis CAS-1000-I2C/E I2C Bus Analyzer and Exerciser Products:

www.corelis.com/products/I2C-Analyzer.htm

Aardvark I2C/SPI Host Adapter Part Number: TP240141

www.totalphase.com/products/aardvark_i2cspi

1.15 Cable References

TI recommends Shielded Twisted Pair (STP) 100ohm differential impedance and 24 AWG (or larger diameter) cable for high-speed data applications.

Leoni Dacar 535-2 series cable:

www.leoni-automotive-cables.com

Rosenberger HSD connector:

www.rosenberger.de/en/Products/35_Automotive_HSD.php

Bill of Materials

Table 2-1. Bill of Materials

Item	Qty	Reference	Description	Manufacturer	Part Number
1	2	CR1,CR2	SUPPRESSOR ESD 24VDC 0603 SMD	Littelfuse Inc	PGB1010603MR
2	16	C1,C5,C8,C9,C10,C12,C13,C14,C16,C17,C22,C26,C28,C33,C35,C37	CAP CER .1UF 50V 10% X7R 0603	Murata Electronics North America	GRM188R71H104KA93D
3	4	C2,C3,C54,C56	CAP CER .1UF 16V X7R 0402	Murata	GCM155R71C104KA55D
4	2	C6,C7	CAP CERAMIC 4.7PF 25V C0G 0402	Panasonic	ECD-G0E4R7C
5	5	C11,C27,C29,C36,C38	CAP CER 10UF 16V X7R 10% 1206.	TDK	C3216X7R1C106K
6	1	C15	CAPACITOR TANT 1.0UF 16V 10% SMD	Kemet	T491A105K016AT
7	2	C18,C19	CAP CERAMIC 15PF 50V NP0 0603	Kemet	C0603C150J5GACTU
8	1	C21	CAP CER 22UF 6.3V 10% X7R 1206	Murata	GCM31CR70J226KE23L
9	2	C23,C32	CAPACITOR TANT 2.2UF 20V 10% SMD	KEMET	T491B225K020AT
10	2	C24,C31	CAP TANTALUM 22UF 25V 20% SMD	nichicon	F931E226MNC
11	12	C25,C40,C41,C42,C43,C44,C45,C46,C51,C52,C53,C55	CAP CER 4.7UF 16V X7R 0805	Murata	490-5332-1-ND
12	1	C30	CAP CERM 33000PF 5% 50V X7R 0603	AVX Corporation	06035C333JAT2A
13	2	D1,LED2	LED ORN/CLEAR 610NM 0402 SMD	Lumex Opto/ Components Inc	SML-LX0402SOC-TR
14	2	D3,D4	DIODE SCHOTTKY 400MW 20V SOD123	Diodes Inc.	SD103CW-13-F
15	1	JP3	CONN HEADER 20POS .100 STR 15AU	FCI	67997-220HLF
16	3	JP5,JP6,JP11	CONN HEADER VERT .100 2POS 30AU	AMP/Tyco	87220-2
17	1	JP7	CONN HEADER VERT .100 3POS 15AU	AMP/Tyco	87224-3
18	4	J1,J2,J11,J12	End Launch Jack Receptacle - Tab Contact	Johnson Components	142-0701-851
19	1	J3	CONN HEADER 20 POS STRGHT GOLD.	3M	N2520-6002RB
20	1	J4	Automotive HSD Connector - Right Angle Plug	Rosenberger	D4S20B-40ML5-Y
21	1	J5	CONN HEADER 4POS .100 VERT GOLD	Molex/Waldom Electronics Corp	22-11-2042
22	1	J6	CONN RECEPT MINI USB2.0 5POS	Hirose	UX60-MB-5ST
23	1	J7	CONN POWER JACK 2.1MM.	CPU Inc	PJ-002A
24	2	J8,J9	BANANA-female (non-insulated)	Johnson	108-0740-001
25	1	LED1	LED GREEN 0.2MM 13MCD 0402 SMD	Rohm	SML-P12PTT86
26	1	L1	CHOKE COIL COMMON MODE 280MA SMD	Murata	DLW21SN900HQ2L
27	2	L2,L4	FERRITE CHIP 1000 OHM 0402	Murata	BLM15AX102SN1D
28	2	R9,R11	RES 0.0 OHM 1/20W 5% 0201 SMD	Panasonic	ERJ-1GE0R00C
29	2	R18,R52	RES 90.9K OHM 1/10W 1% 0402 SMD	Panasonic	ERJ-2RKF9092X
30	1	R19	RES 137K OHM 1/10W 1% 0402 SMD	Panasonic	ERJ-2RKF1373X
31	1	R20	RES 150K OHM 1/10W 1% 0402 SMD	Panasonic	ERJ-2RKF1503X
32	1	R21	RES 154K OHM 1/10W 1% 0402 SMD	Panasonic	ERJ-2RKF1543X
33	1	R22	RES 174K OHM 1/10W 1% 0402 SMD	Panasonic	ERJ-2RKF1743X
34	1	R23	RES 187K OHM 1/10W 1% 0402 SMD	Panasonic	ERJ-2RKF1873X
35	1	R24	RES 200K OHM 1/10W 1% 0402 SMD	Panasonic	ERJ-2RKF2003X
36	1	R25	RES 215K OHM 1/10W 1% 0402 SMD	Panasonic	ERJ-2RKF2153X
37	1	R26	RES 226K OHM 1/10W 1% 0402 SMD	Panasonic	ERJ-2RKF2263X

Table 2-1. Bill of Materials (continued)

Item	Qty	Reference	Description	Manufacturer	Part Number
38	2	R27,R43	RES 243K OHM 1/10W 1% 0402 SMD	Panasonic	ERJ-2RKF2433X
39	1	R28	RES 240K OHM 1/10W 1% 0402 SMD	Panasonic	ERJ-2RKF2403X
40	1	R29	RES 267K OHM 1/10W 1% 0402 SMD	Panasonic	ERJ-2RKF2673X
41	1	R30	RES 270K OHM 1/10W 1% 0402 SMD	Panasonic	ERJ-2RKF2703X
42	1	R31	RES 280K OHM 1/10W 1% 0402 SMD	Panasonic	ERJ-2RKF2803X
43	1	R32	RES 294K OHM 1/10W 1% 0402 SMD	Panasonic	ERJ-2RKF2943X
44	7	R37,R38,R97,R103,R104,R105,R106	RES 10.0K OHM 1/10W 1% 0603 SMD	Panasonic	ERJ-3EKF1002V
45	2	R44,R114	RES 210K OHM 1/10W 1% 0402 SMD	Panasonic	ERJ-2RKF2103X
46	1	R45	RES 191K OHM 1/10W 1% 0402 SMD	Panasonic	ERJ-2RKF1913X
47	1	R46	RES 165K OHM 1/10W 1% 0402 SMD	Panasonic	ERJ-2RKF1653X
48	1	R47	RES 158K OHM 1/10W 1% 0402 SMD	Panasonic	ERJ-2RKF1583X
49	1	R48	RES 140K OHM 1/10W 1% 0402 SMD	Panasonic	ERJ-2RKF1403X
50	1	R49	RES 127K OHM 1/10W 1% 0402 SMD	Panasonic	ERJ-2RKF1273X
51	1	R50	RES 113K OHM 1/10W 1% 0402 SMD	Panasonic	ERJ-2RKF1133X
52	1	R51	RES 97.6K OHM 1/10W 1% 0402 SMD	Panasonic	ERJ-2RKF9762X
53	1	R53	RES 76.8K OHM 1/10W 1% 0402 SMD	Panasonic	ERJ-2RKF7682X
54	1	R54	RES 71.5K OHM 1/10W 1% 0402 SMD	Panasonic	ERJ-2RKF7152X
55	1	R55	RES 60.4K OHM 1/10W 1% 0402 SMD	Panasonic	ERJ-2RKF6042X
56	1	R56	RES 49.9K OHM 1/10W 1% 0402 SMD	Panasonic	ERJ-2RKF4992X
57	2	R57,R58	RES 40.2K OHM 1/10W 1% 0402 SMD	Panasonic	ERJ-2RKF4022X
58	2	R59,R60	RES 4.7K OHM 1/10W 5% 0603 SMD	Panasonic	ERJ-3GEYJ472V
59	8	R62,R63,R64,R65,R95,R96,R120,R121	RES ZERO OHM 1/16W 5% 0402 SMD	Panasonic	ERJ-2GEJ0R00X
60	4	R66,R91,R99,R101	RES ZERO OHM 1/10W 5% 0603 SMD	Panasonic	ERJ-3GEY0R00V
61	2	R67,R119	RES 68 OHM 1/10W 5% 0402 SMD	Panasonic	ERJ-2GEJ680X
62	5	R68,R74,R82,R86,R102	RES 100K OHM 1/10W 5% 0402 SMD	Panasonic	ERJ-2GEJ104X
63	2	R69,R70	RES 22 OHM 1/16W 3300PPM 5% 0603	Panasonic	ERA-V33J220V
64	2	R75,R76	RES ZERO OHM 1/4W 5% 1206 SMD	Panasonic	ERJ-8GEY0R00V
65	1	R81	RES 2.49K OHM 1/10W 1% 0603 SMD	Vishay/Dale	CRCW06032K49FKEA
66	2	R83,R87	RES 5.62K OHM 1/10W 1% 0603 SMD.	Vishay	CRCW06035K62FKEA
67	1	R85	RES 9.31K OHM 1/10W 1% 0603 SMD	Vishay/Dale	CRCW06039K31FKEA
68	1	R109	RES 124K OHM 1/10W 1% 0603 SMD	Panasonic	ERJ-3EKF1243V
69	1	R119	RES 255K OHM 1/10W 1% 0603 SMD	Panasonic	ERJ-3EKF2553V
70	1	R115	RES 49.9K OHM 1/10W 1% 0603 SMD	Panasonic	ERJ-3EKF4992V
71	1	R116	RES 40.2K OHM 1/10W 1% 0603 SMD	Panasonic	ERJ-3EKF4022V
72	1	R118	RES 56 OHM 1/10W 5% 0402 SMD	Panasonic	ERJ-2GEJ560X
73	2	SW1,SW2	SWITCH TACT	APEM Components	ADTSM31NV
74	1	S1	SWITCH DIP EXTENDED SEALED 4POS	Grayhill	78B04ST
75	2	S2,S3	SWITCH TAPE SEAL 8 POS SMD	CTS Electrocomponents	219-8MST
76	1	S4	SWITCH DIP EXTENDED UNSEAL 3POS	Grayhill	78B03T
77	1	S5	SWITCH TAPE SEAL 3 POS SMD	CTS Electrocomponents	219-3MST
78	1	U1	FPD-Link III Deserializer LVDS	TI	DS90UB924-Q1
79	1	U2	IC AVR MCU 128K 64QFN	Atmel	AT90USB1287-16MU
80	2	U4,U5	IC REG LDO 500MA ADJ SOT223-4	TI	LP38693MP-ADJ/NOPB
81	1	U6	IC REG LDO 300MA 3.3V 8MSOP	TI	LP3982IMM-3.3/NOPB
82	1	Y1	CRYSTAL 8.000 MHZ 18PF SMD	Abrakon Corporation	ABM3-8.000MHZ-D2Y-T

EVM PCB Schematics

A.1 Board Stackup

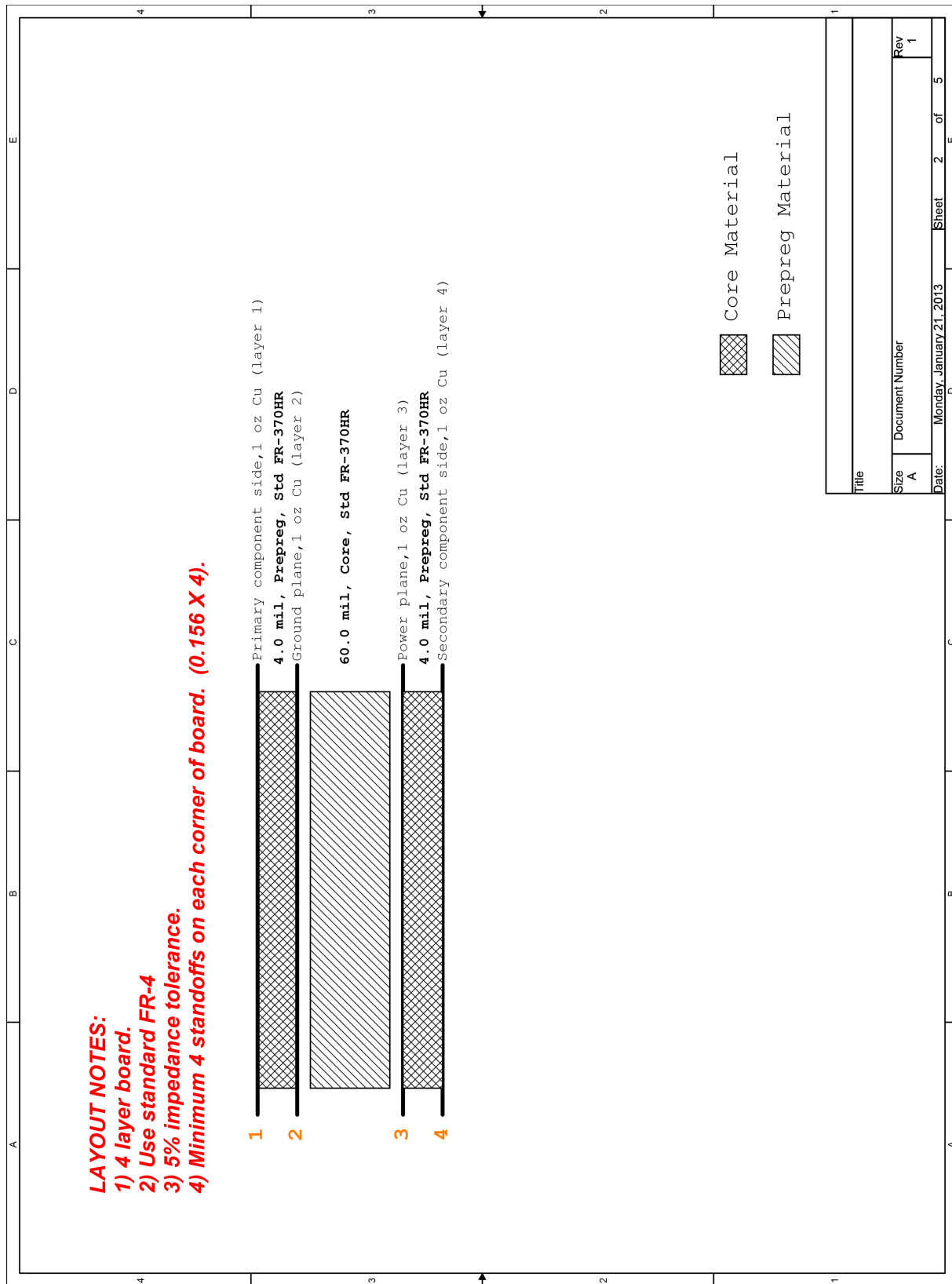

Figure A-1. Board Stackup

A.4 Power

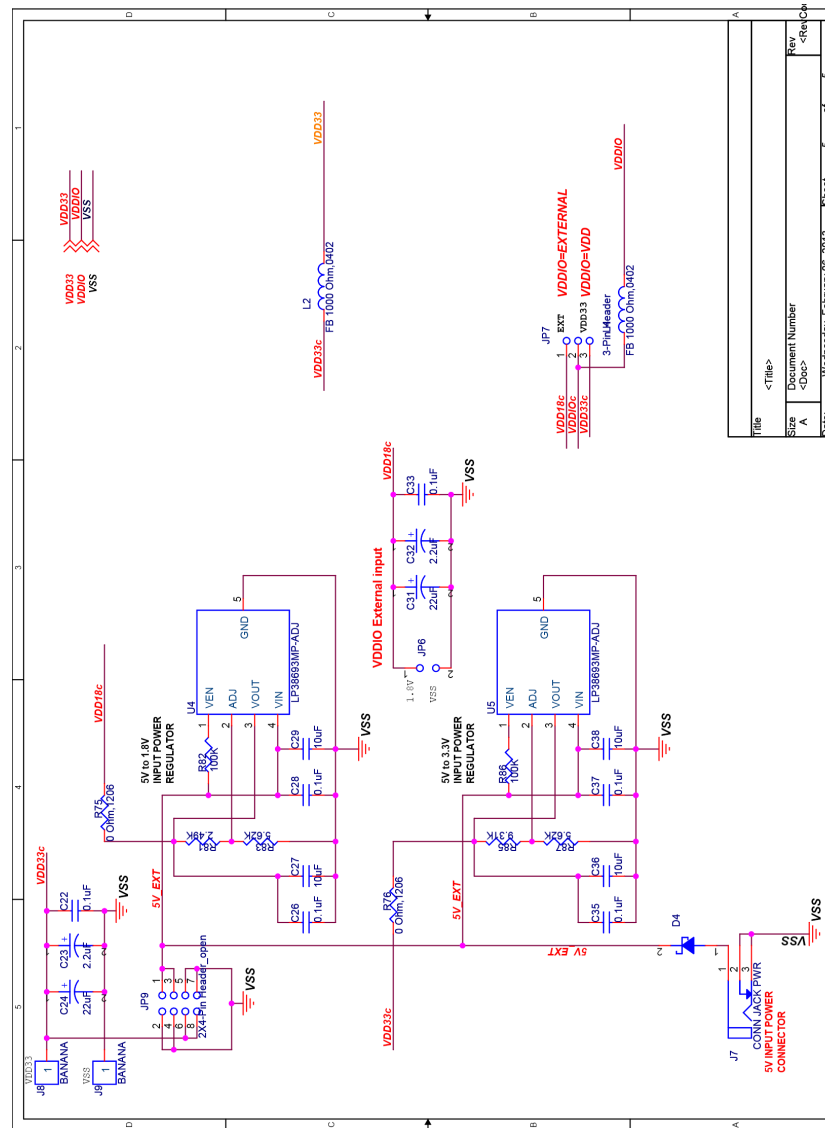
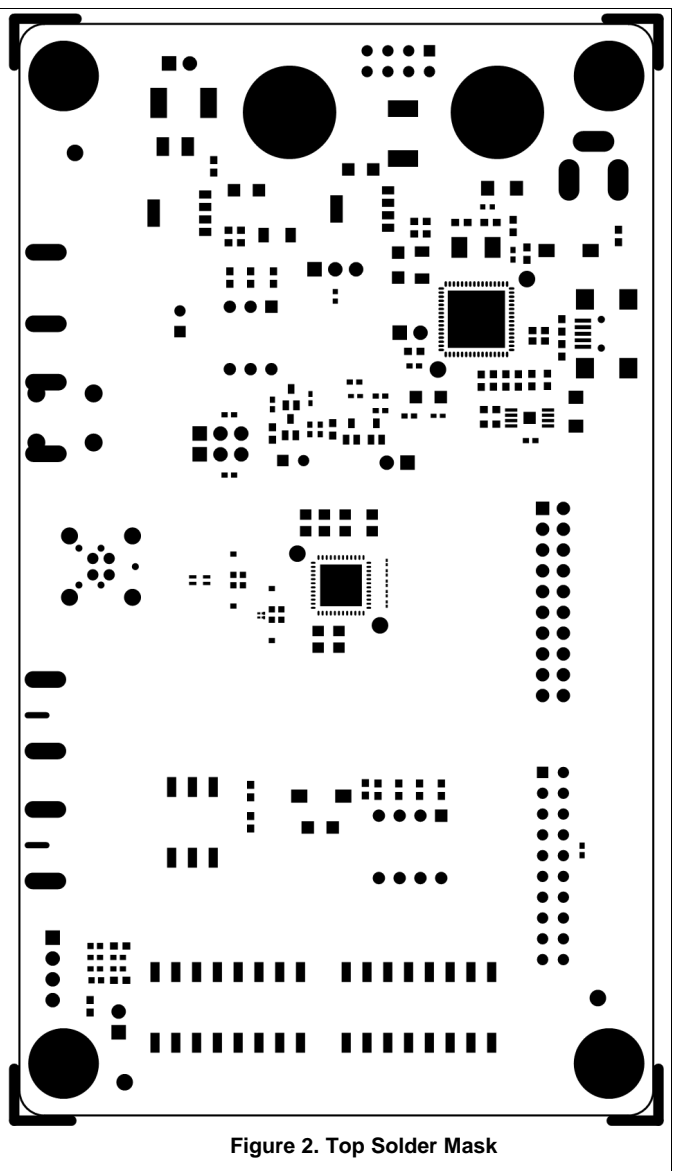
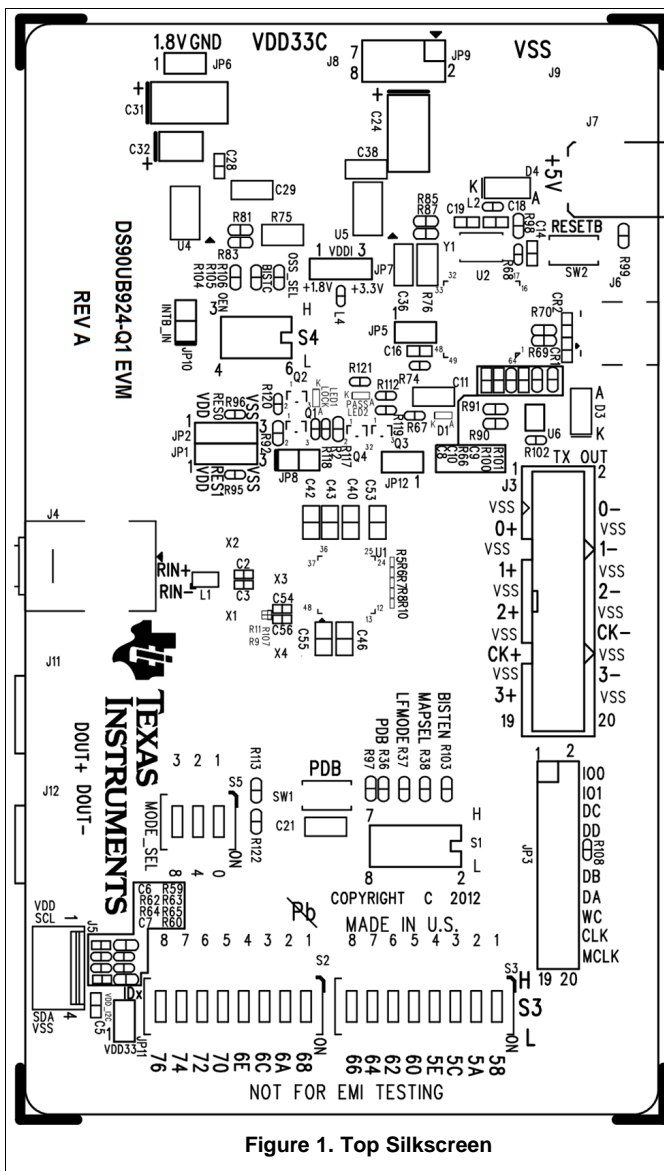

Figure A-4. Power

Board Layout

B.1 Board Layers

The following mechanical drawings (not to scale) illustrate the physical layout and stack-up of the 4-layer evaluation board:



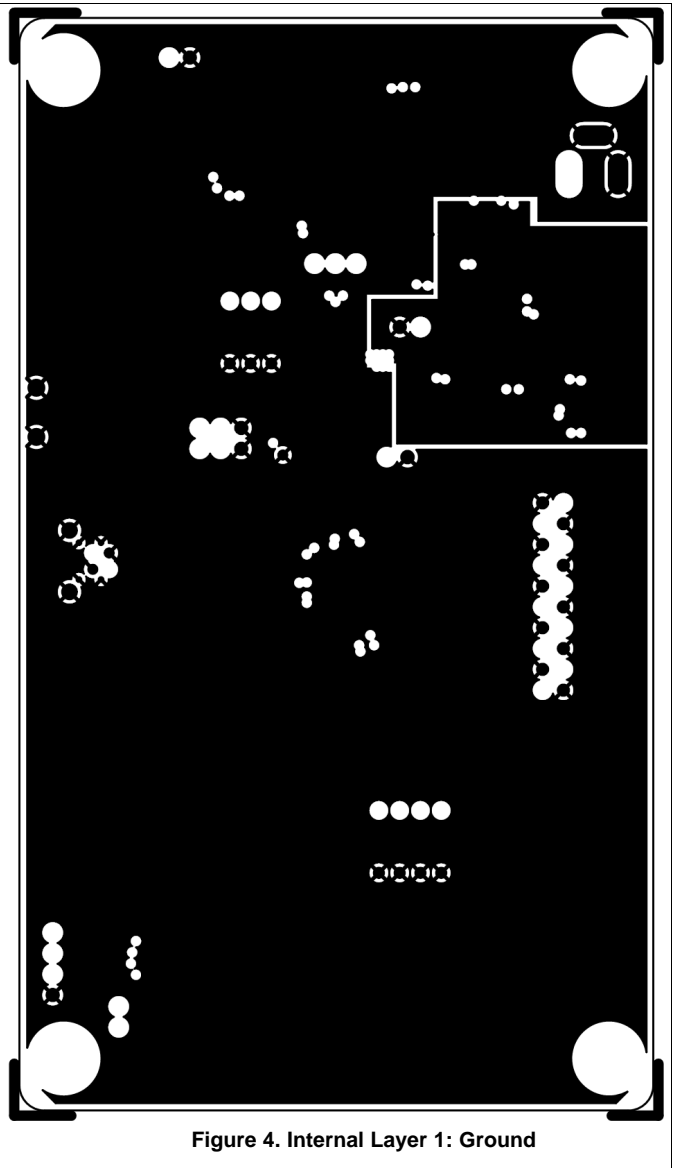
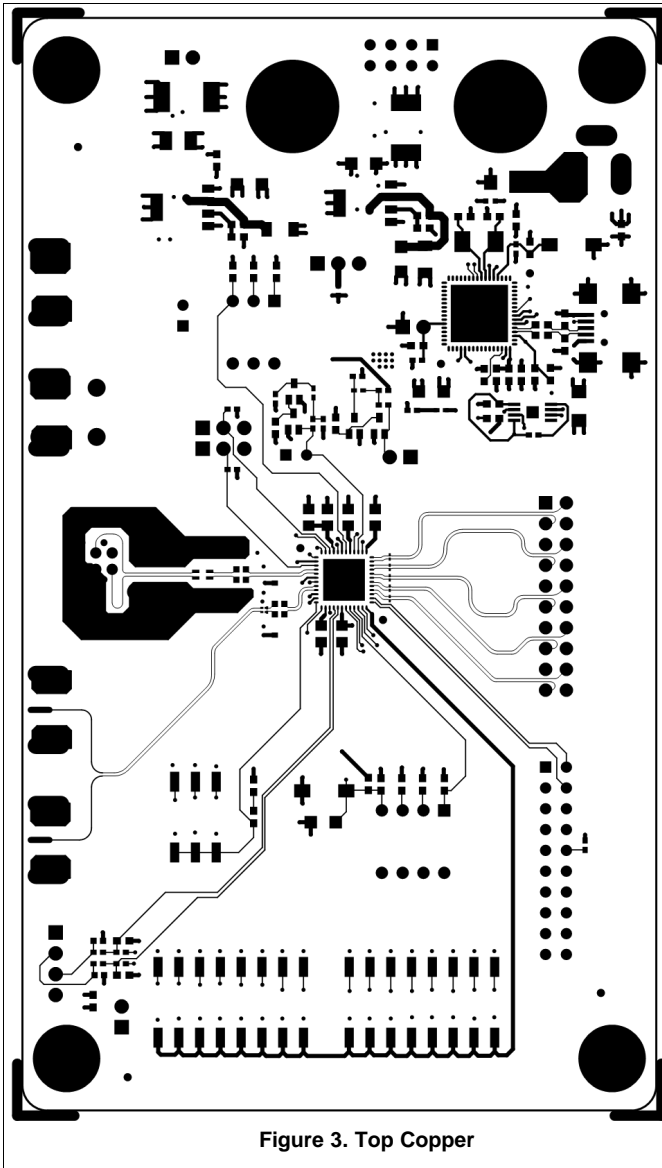

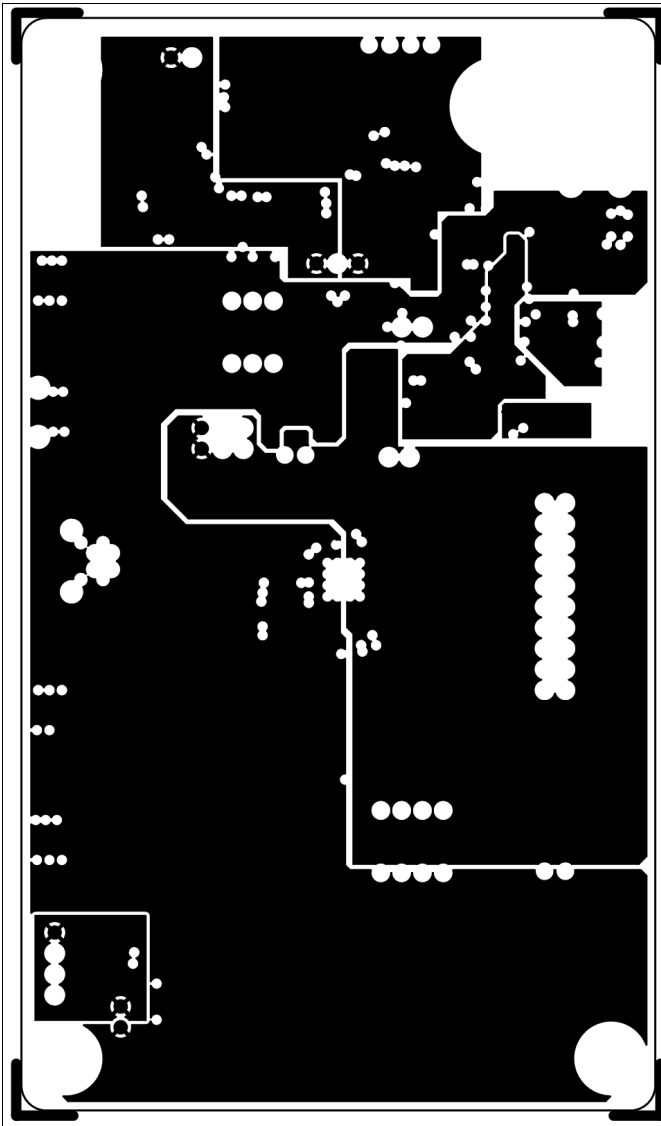

Figure 5. Internal Layer 2: Power

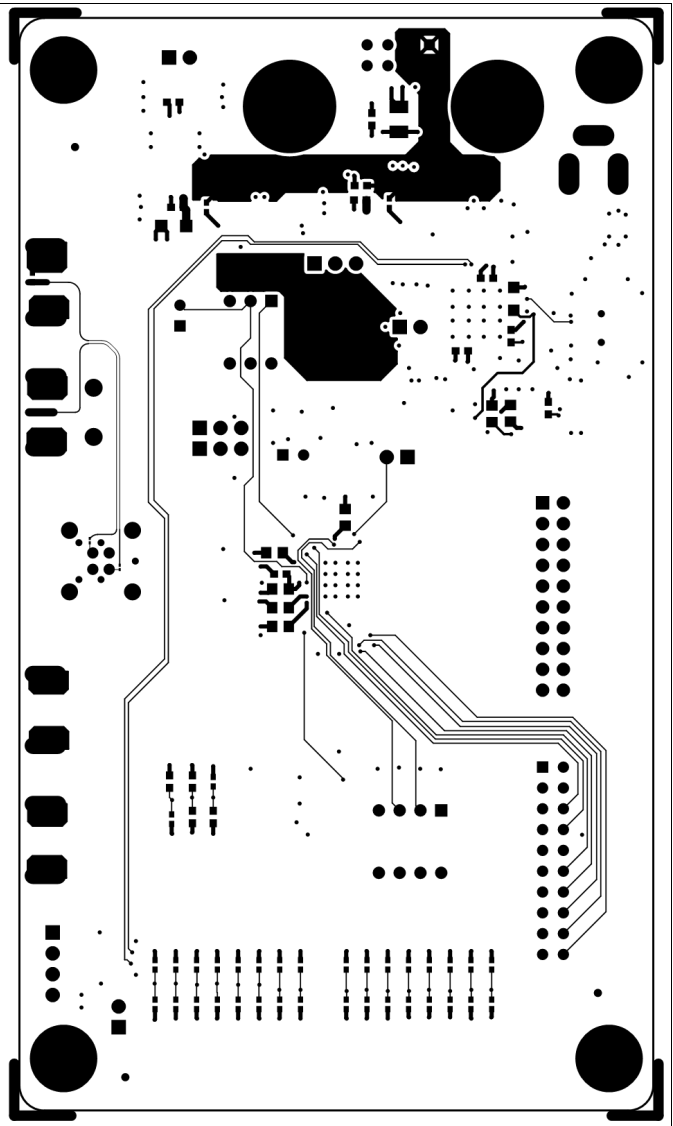

Figure 6. Bottom Copper

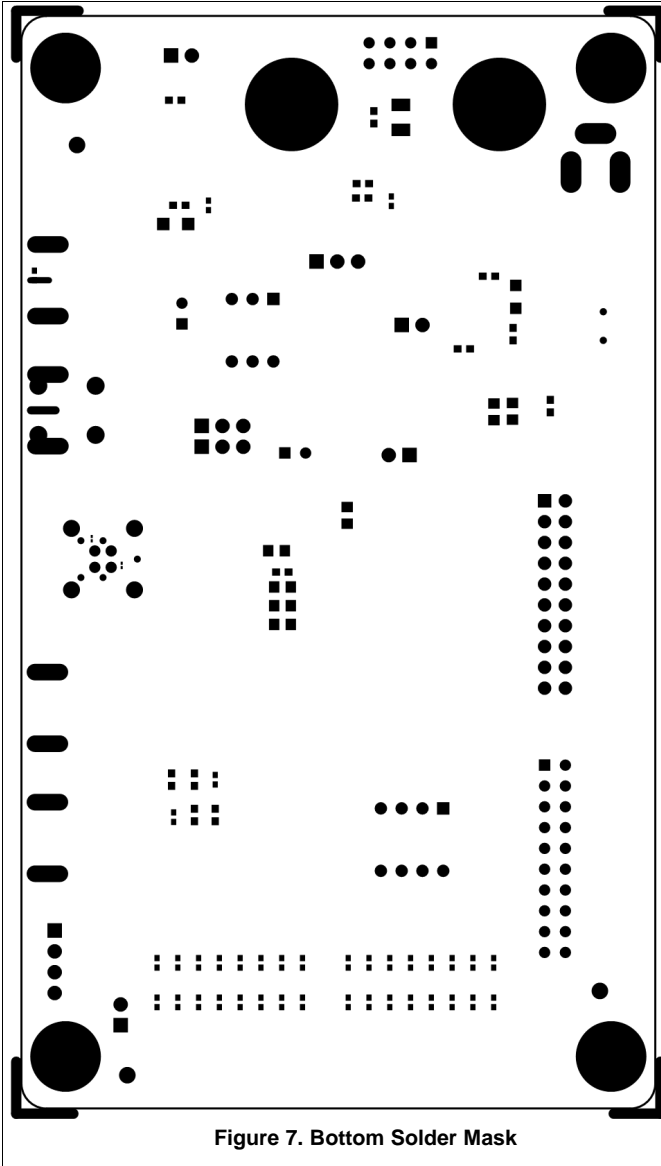

Figure 7. Bottom Solder Mask

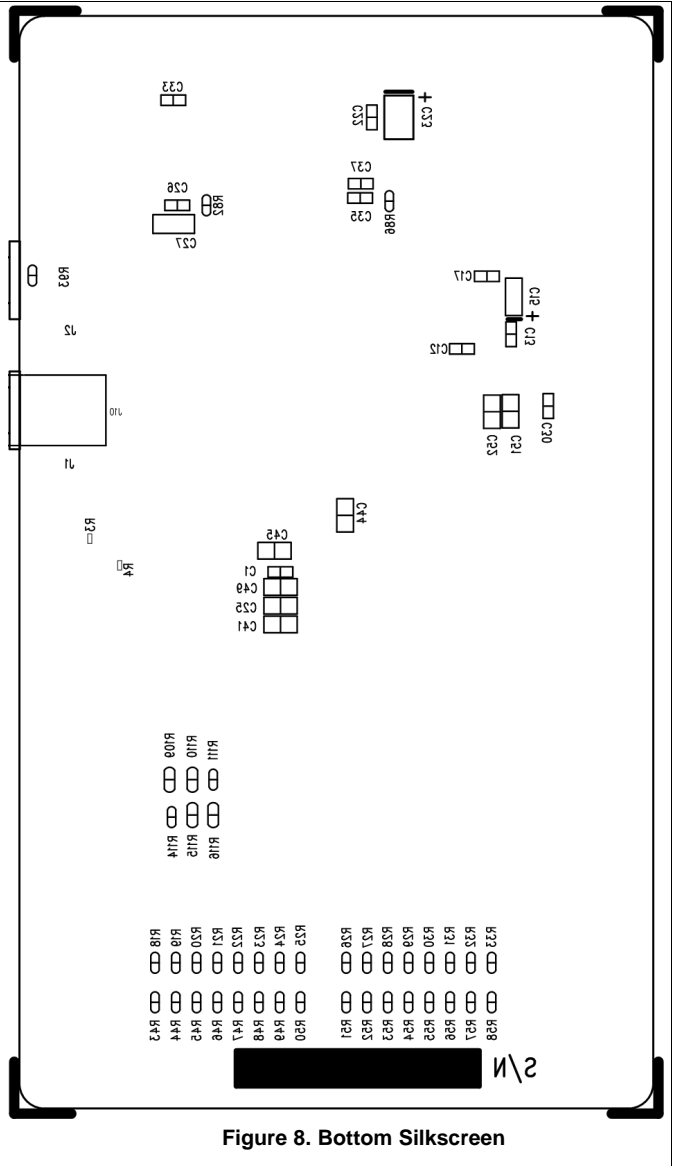

Figure 8. Bottom Silkscreen

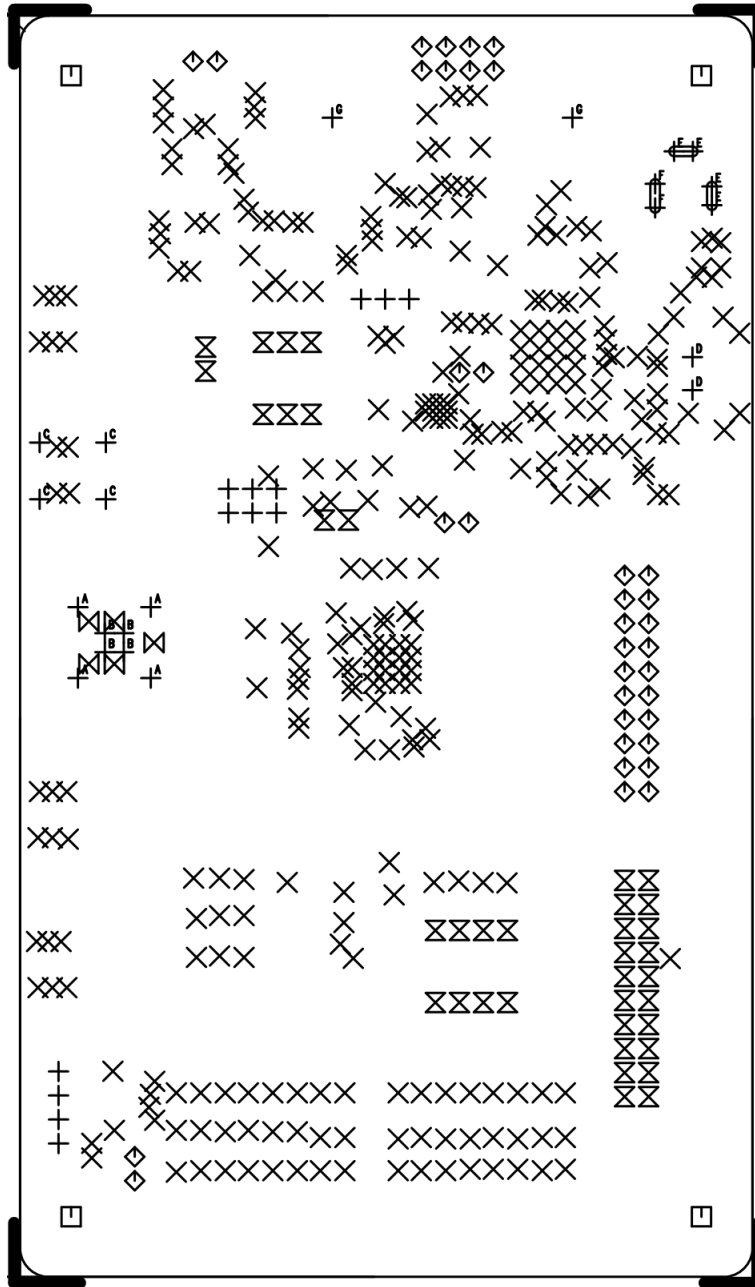

Figure 9. Drill

STANDARD TERMS AND CONDITIONS FOR EVALUATION MODULES

1. *Delivery:* TI delivers TI evaluation boards, kits, or modules, including any accompanying demonstration software, components, or documentation (collectively, an "EVM" or "EVMs") to the User ("User") in accordance with the terms and conditions set forth herein. Acceptance of the EVM is expressly subject to the following terms and conditions.
 - 1.1 EVMs are intended solely for product or software developers for use in a research and development setting to facilitate feasibility evaluation, experimentation, or scientific analysis of TI semiconductor products. EVMs have no direct function and are not finished products. EVMs shall not be directly or indirectly assembled as a part or subassembly in any finished product. For clarification, any software or software tools provided with the EVM ("Software") shall not be subject to the terms and conditions set forth herein but rather shall be subject to the applicable terms and conditions that accompany such Software
 - 1.2 EVMs are not intended for consumer or household use. EVMs may not be sold, sublicensed, leased, rented, loaned, assigned, or otherwise distributed for commercial purposes by Users, in whole or in part, or used in any finished product or production system.
2. *Limited Warranty and Related Remedies/Disclaimers:*
 - 2.1 These terms and conditions do not apply to Software. The warranty, if any, for Software is covered in the applicable Software License Agreement.
 - 2.2 TI warrants that the TI EVM will conform to TI's published specifications for ninety (90) days after the date TI delivers such EVM to User. Notwithstanding the foregoing, TI shall not be liable for any defects that are caused by neglect, misuse or mistreatment by an entity other than TI, including improper installation or testing, or for any EVMs that have been altered or modified in any way by an entity other than TI. Moreover, TI shall not be liable for any defects that result from User's design, specifications or instructions for such EVMs. Testing and other quality control techniques are used to the extent TI deems necessary or as mandated by government requirements. TI does not test all parameters of each EVM.
 - 2.3 If any EVM fails to conform to the warranty set forth above, TI's sole liability shall be at its option to repair or replace such EVM, or credit User's account for such EVM. TI's liability under this warranty shall be limited to EVMs that are returned during the warranty period to the address designated by TI and that are determined by TI not to conform to such warranty. If TI elects to repair or replace such EVM, TI shall have a reasonable time to repair such EVM or provide replacements. Repaired EVMs shall be warranted for the remainder of the original warranty period. Replaced EVMs shall be warranted for a new full ninety (90) day warranty period.
3. *Regulatory Notices:*
 - 3.1 *United States*
 - 3.1.1 *Notice applicable to EVMs not FCC-Approved:*

This kit is designed to allow product developers to evaluate electronic components, circuitry, or software associated with the kit to determine whether to incorporate such items in a finished product and software developers to write software applications for use with the end product. This kit is not a finished product and when assembled may not be resold or otherwise marketed unless all required FCC equipment authorizations are first obtained. Operation is subject to the condition that this product not cause harmful interference to licensed radio stations and that this product accept harmful interference. Unless the assembled kit is designed to operate under part 15, part 18 or part 95 of this chapter, the operator of the kit must operate under the authority of an FCC license holder or must secure an experimental authorization under part 5 of this chapter.
 - 3.1.2 *For EVMs annotated as FCC – FEDERAL COMMUNICATIONS COMMISSION Part 15 Compliant:*

CAUTION

This device complies with part 15 of the FCC Rules. Operation is subject to the following two conditions: (1) This device may not cause harmful interference, and (2) this device must accept any interference received, including interference that may cause undesired operation.

Changes or modifications not expressly approved by the party responsible for compliance could void the user's authority to operate the equipment.

FCC Interference Statement for Class A EVM devices

NOTE: This equipment has been tested and found to comply with the limits for a Class A digital device, pursuant to part 15 of the FCC Rules. These limits are designed to provide reasonable protection against harmful interference when the equipment is operated in a commercial environment. This equipment generates, uses, and can radiate radio frequency energy and, if not installed and used in accordance with the instruction manual, may cause harmful interference to radio communications. Operation of this equipment in a residential area is likely to cause harmful interference in which case the user will be required to correct the interference at his own expense.

FCC Interference Statement for Class B EVM devices

NOTE: This equipment has been tested and found to comply with the limits for a Class B digital device, pursuant to part 15 of the FCC Rules. These limits are designed to provide reasonable protection against harmful interference in a residential installation. This equipment generates, uses and can radiate radio frequency energy and, if not installed and used in accordance with the instructions, may cause harmful interference to radio communications. However, there is no guarantee that interference will not occur in a particular installation. If this equipment does cause harmful interference to radio or television reception, which can be determined by turning the equipment off and on, the user is encouraged to try to correct the interference by one or more of the following measures:

- Reorient or relocate the receiving antenna.
- Increase the separation between the equipment and receiver.
- Connect the equipment into an outlet on a circuit different from that to which the receiver is connected.
- Consult the dealer or an experienced radio/TV technician for help.

3.2 Canada

3.2.1 For EVMs issued with an Industry Canada Certificate of Conformance to RSS-210

Concerning EVMs Including Radio Transmitters:

This device complies with Industry Canada license-exempt RSS standard(s). Operation is subject to the following two conditions: (1) this device may not cause interference, and (2) this device must accept any interference, including interference that may cause undesired operation of the device.

Concernant les EVMs avec appareils radio:

Le présent appareil est conforme aux CNR d'Industrie Canada applicables aux appareils radio exempts de licence. L'exploitation est autorisée aux deux conditions suivantes: (1) l'appareil ne doit pas produire de brouillage, et (2) l'utilisateur de l'appareil doit accepter tout brouillage radioélectrique subi, même si le brouillage est susceptible d'en compromettre le fonctionnement.

Concerning EVMs Including Detachable Antennas:

Under Industry Canada regulations, this radio transmitter may only operate using an antenna of a type and maximum (or lesser) gain approved for the transmitter by Industry Canada. To reduce potential radio interference to other users, the antenna type and its gain should be so chosen that the equivalent isotropically radiated power (e.i.r.p.) is not more than that necessary for successful communication. This radio transmitter has been approved by Industry Canada to operate with the antenna types listed in the user guide with the maximum permissible gain and required antenna impedance for each antenna type indicated. Antenna types not included in this list, having a gain greater than the maximum gain indicated for that type, are strictly prohibited for use with this device.

Concernant les EVMs avec antennes détachables

Conformément à la réglementation d'Industrie Canada, le présent émetteur radio peut fonctionner avec une antenne d'un type et d'un gain maximal (ou inférieur) approuvé pour l'émetteur par Industrie Canada. Dans le but de réduire les risques de brouillage radioélectrique à l'intention des autres utilisateurs, il faut choisir le type d'antenne et son gain de sorte que la puissance isotrope rayonnée équivalente (p.i.r.e.) ne dépasse pas l'intensité nécessaire à l'établissement d'une communication satisfaisante. Le présent émetteur radio a été approuvé par Industrie Canada pour fonctionner avec les types d'antenne énumérés dans le manuel d'usage et ayant un gain admissible maximal et l'impédance requise pour chaque type d'antenne. Les types d'antenne non inclus dans cette liste, ou dont le gain est supérieur au gain maximal indiqué, sont strictement interdits pour l'exploitation de l'émetteur.

3.3 Japan

3.3.1 *Notice for EVMs delivered in Japan:* Please see http://www.tij.co.jp/lstds/ti_ja/general/eStore/notice_01.page 日本国内に輸入される評価用キット、ボードについては、次のところをご覧ください。
http://www.tij.co.jp/lstds/ti_ja/general/eStore/notice_01.page

3.3.2 *Notice for Users of EVMs Considered "Radio Frequency Products" in Japan:* EVMs entering Japan may not be certified by TI as conforming to Technical Regulations of Radio Law of Japan.

If User uses EVMs in Japan, not certified to Technical Regulations of Radio Law of Japan, User is required by Radio Law of Japan to follow the instructions below with respect to EVMs:

1. Use EVMs in a shielded room or any other test facility as defined in the notification #173 issued by Ministry of Internal Affairs and Communications on March 28, 2006, based on Sub-section 1.1 of Article 6 of the Ministry's Rule for Enforcement of Radio Law of Japan,
2. Use EVMs only after User obtains the license of Test Radio Station as provided in Radio Law of Japan with respect to EVMs, or
3. Use of EVMs only after User obtains the Technical Regulations Conformity Certification as provided in Radio Law of Japan with respect to EVMs. Also, do not transfer EVMs, unless User gives the same notice above to the transferee. Please note that if User does not follow the instructions above, User will be subject to penalties of Radio Law of Japan.

【無線電波を送信する製品の開発キットをお使いになる際の注意事項】 開発キットの中には技術基準適合証明を受けていないものがあります。技術適合証明を受けていないものご使用に際しては、電波法遵守のため、以下のいずれかの措置を取っていただく必要がありますのでご注意ください。

1. 電波法施行規則第6条第1項第1号に基づく平成18年3月28日総務省告示第173号で定められた電波暗室等の試験設備でご使用いただく。
2. 実験局の免許を取得後ご使用いただく。
3. 技術基準適合証明を取得後ご使用いただく。

なお、本製品は、上記の「ご使用にあたっての注意」を譲渡先、移転先に通知しない限り、譲渡、移転できないものとします。

上記を遵守頂けない場合は、電波法の罰則が適用される可能性があることをご留意ください。日本テキサス・インスツルメンツ株式会社
東京都新宿区西新宿 6 丁目 2 4 番 1 号
西新宿三井ビル

3.3.3 *Notice for EVMs for Power Line Communication:* Please see http://www.tij.co.jp/llds/ti_ja/general/eStore/notice_02.page
電力線搬送波通信についての開発キットをお使いになる際の注意事項については、次のところをご覧ください。http://www.tij.co.jp/llds/ti_ja/general/eStore/notice_02.page

4 *EVM Use Restrictions and Warnings:*

4.1 EVMS ARE NOT FOR USE IN FUNCTIONAL SAFETY AND/OR SAFETY CRITICAL EVALUATIONS, INCLUDING BUT NOT LIMITED TO EVALUATIONS OF LIFE SUPPORT APPLICATIONS.

4.2 User must read and apply the user guide and other available documentation provided by TI regarding the EVM prior to handling or using the EVM, including without limitation any warning or restriction notices. The notices contain important safety information related to, for example, temperatures and voltages.

4.3 *Safety-Related Warnings and Restrictions:*

4.3.1 User shall operate the EVM within TI's recommended specifications and environmental considerations stated in the user guide, other available documentation provided by TI, and any other applicable requirements and employ reasonable and customary safeguards. Exceeding the specified performance ratings and specifications (including but not limited to input and output voltage, current, power, and environmental ranges) for the EVM may cause personal injury or death, or property damage. If there are questions concerning performance ratings and specifications, User should contact a TI field representative prior to connecting interface electronics including input power and intended loads. Any loads applied outside of the specified output range may also result in unintended and/or inaccurate operation and/or possible permanent damage to the EVM and/or interface electronics. Please consult the EVM user guide prior to connecting any load to the EVM output. If there is uncertainty as to the load specification, please contact a TI field representative. During normal operation, even with the inputs and outputs kept within the specified allowable ranges, some circuit components may have elevated case temperatures. These components include but are not limited to linear regulators, switching transistors, pass transistors, current sense resistors, and heat sinks, which can be identified using the information in the associated documentation. When working with the EVM, please be aware that the EVM may become very warm.

4.3.2 EVMs are intended solely for use by technically qualified, professional electronics experts who are familiar with the dangers and application risks associated with handling electrical mechanical components, systems, and subsystems. User assumes all responsibility and liability for proper and safe handling and use of the EVM by User or its employees, affiliates, contractors or designees. User assumes all responsibility and liability to ensure that any interfaces (electronic and/or mechanical) between the EVM and any human body are designed with suitable isolation and means to safely limit accessible leakage currents to minimize the risk of electrical shock hazard. User assumes all responsibility and liability for any improper or unsafe handling or use of the EVM by User or its employees, affiliates, contractors or designees.

4.4 User assumes all responsibility and liability to determine whether the EVM is subject to any applicable international, federal, state, or local laws and regulations related to User's handling and use of the EVM and, if applicable, User assumes all responsibility and liability for compliance in all respects with such laws and regulations. User assumes all responsibility and liability for proper disposal and recycling of the EVM consistent with all applicable international, federal, state, and local requirements.

5. *Accuracy of Information:* To the extent TI provides information on the availability and function of EVMs, TI attempts to be as accurate as possible. However, TI does not warrant the accuracy of EVM descriptions, EVM availability or other information on its websites as accurate, complete, reliable, current, or error-free.

6. *Disclaimers:*

6.1 EXCEPT AS SET FORTH ABOVE, EVMS AND ANY WRITTEN DESIGN MATERIALS PROVIDED WITH THE EVM (AND THE DESIGN OF THE EVM ITSELF) ARE PROVIDED "AS IS" AND "WITH ALL FAULTS." TI DISCLAIMS ALL OTHER WARRANTIES, EXPRESS OR IMPLIED, REGARDING SUCH ITEMS, INCLUDING BUT NOT LIMITED TO ANY IMPLIED WARRANTIES OF MERCHANTABILITY OR FITNESS FOR A PARTICULAR PURPOSE OR NON-INFRINGEMENT OF ANY THIRD PARTY PATENTS, COPYRIGHTS, TRADE SECRETS OR OTHER INTELLECTUAL PROPERTY RIGHTS.

6.2 EXCEPT FOR THE LIMITED RIGHT TO USE THE EVM SET FORTH HEREIN, NOTHING IN THESE TERMS AND CONDITIONS SHALL BE CONSTRUED AS GRANTING OR CONFERRING ANY RIGHTS BY LICENSE, PATENT, OR ANY OTHER INDUSTRIAL OR INTELLECTUAL PROPERTY RIGHT OF TI, ITS SUPPLIERS/LICENSORS OR ANY OTHER THIRD PARTY, TO USE THE EVM IN ANY FINISHED END-USER OR READY-TO-USE FINAL PRODUCT, OR FOR ANY INVENTION, DISCOVERY OR IMPROVEMENT MADE, CONCEIVED OR ACQUIRED PRIOR TO OR AFTER DELIVERY OF THE EVM.

7. *USER'S INDEMNITY OBLIGATIONS AND REPRESENTATIONS.* USER WILL DEFEND, INDEMNIFY AND HOLD TI, ITS LICENSORS AND THEIR REPRESENTATIVES HARMLESS FROM AND AGAINST ANY AND ALL CLAIMS, DAMAGES, LOSSES, EXPENSES, COSTS AND LIABILITIES (COLLECTIVELY, "CLAIMS") ARISING OUT OF OR IN CONNECTION WITH ANY HANDLING OR USE OF THE EVM THAT IS NOT IN ACCORDANCE WITH THESE TERMS AND CONDITIONS. THIS OBLIGATION SHALL APPLY WHETHER CLAIMS ARISE UNDER STATUTE, REGULATION, OR THE LAW OF TORT, CONTRACT OR ANY OTHER LEGAL THEORY, AND EVEN IF THE EVM FAILS TO PERFORM AS DESCRIBED OR EXPECTED.

8. *Limitations on Damages and Liability:*

8.1 *General Limitations.* IN NO EVENT SHALL TI BE LIABLE FOR ANY SPECIAL, COLLATERAL, INDIRECT, PUNITIVE, INCIDENTAL, CONSEQUENTIAL, OR EXEMPLARY DAMAGES IN CONNECTION WITH OR ARISING OUT OF THESE TERMS AND CONDITIONS OR THE USE OF THE EVMS PROVIDED HEREUNDER, REGARDLESS OF WHETHER TI HAS BEEN ADVISED OF THE POSSIBILITY OF SUCH DAMAGES. EXCLUDED DAMAGES INCLUDE, BUT ARE NOT LIMITED TO, COST OF REMOVAL OR REINSTALLATION, ANCILLARY COSTS TO THE PROCUREMENT OF SUBSTITUTE GOODS OR SERVICES, RETESTING, OUTSIDE COMPUTER TIME, LABOR COSTS, LOSS OF GOODWILL, LOSS OF PROFITS, LOSS OF SAVINGS, LOSS OF USE, LOSS OF DATA, OR BUSINESS INTERRUPTION. NO CLAIM, SUIT OR ACTION SHALL BE BROUGHT AGAINST TI MORE THAN ONE YEAR AFTER THE RELATED CAUSE OF ACTION HAS OCCURRED.

8.2 *Specific Limitations.* IN NO EVENT SHALL TI'S AGGREGATE LIABILITY FROM ANY WARRANTY OR OTHER OBLIGATION ARISING OUT OF OR IN CONNECTION WITH THESE TERMS AND CONDITIONS, OR ANY USE OF ANY TI EVM PROVIDED HEREUNDER, EXCEED THE TOTAL AMOUNT PAID TO TI FOR THE PARTICULAR UNITS SOLD UNDER THESE TERMS AND CONDITIONS WITH RESPECT TO WHICH LOSSES OR DAMAGES ARE CLAIMED. THE EXISTENCE OF MORE THAN ONE CLAIM AGAINST THE PARTICULAR UNITS SOLD TO USER UNDER THESE TERMS AND CONDITIONS SHALL NOT ENLARGE OR EXTEND THIS LIMIT.

9. *Return Policy.* Except as otherwise provided, TI does not offer any refunds, returns, or exchanges. Furthermore, no return of EVM(s) will be accepted if the package has been opened and no return of the EVM(s) will be accepted if they are damaged or otherwise not in a resalable condition. If User feels it has been incorrectly charged for the EVM(s) it ordered or that delivery violates the applicable order, User should contact TI. All refunds will be made in full within thirty (30) working days from the return of the components(s), excluding any postage or packaging costs.

10. *Governing Law:* These terms and conditions shall be governed by and interpreted in accordance with the laws of the State of Texas, without reference to conflict-of-laws principles. User agrees that non-exclusive jurisdiction for any dispute arising out of or relating to these terms and conditions lies within courts located in the State of Texas and consents to venue in Dallas County, Texas. Notwithstanding the foregoing, any judgment may be enforced in any United States or foreign court, and TI may seek injunctive relief in any United States or foreign court.

IMPORTANT NOTICE

Texas Instruments Incorporated and its subsidiaries (TI) reserve the right to make corrections, enhancements, improvements and other changes to its semiconductor products and services per JESD46, latest issue, and to discontinue any product or service per JESD48, latest issue. Buyers should obtain the latest relevant information before placing orders and should verify that such information is current and complete. All semiconductor products (also referred to herein as "components") are sold subject to TI's terms and conditions of sale supplied at the time of order acknowledgment.

TI warrants performance of its components to the specifications applicable at the time of sale, in accordance with the warranty in TI's terms and conditions of sale of semiconductor products. Testing and other quality control techniques are used to the extent TI deems necessary to support this warranty. Except where mandated by applicable law, testing of all parameters of each component is not necessarily performed.

TI assumes no liability for applications assistance or the design of Buyers' products. Buyers are responsible for their products and applications using TI components. To minimize the risks associated with Buyers' products and applications, Buyers should provide adequate design and operating safeguards.

TI does not warrant or represent that any license, either express or implied, is granted under any patent right, copyright, mask work right, or other intellectual property right relating to any combination, machine, or process in which TI components or services are used. Information published by TI regarding third-party products or services does not constitute a license to use such products or services or a warranty or endorsement thereof. Use of such information may require a license from a third party under the patents or other intellectual property of the third party, or a license from TI under the patents or other intellectual property of TI.

Reproduction of significant portions of TI information in TI data books or data sheets is permissible only if reproduction is without alteration and is accompanied by all associated warranties, conditions, limitations, and notices. TI is not responsible or liable for such altered documentation. Information of third parties may be subject to additional restrictions.

Resale of TI components or services with statements different from or beyond the parameters stated by TI for that component or service voids all express and any implied warranties for the associated TI component or service and is an unfair and deceptive business practice. TI is not responsible or liable for any such statements.

Buyer acknowledges and agrees that it is solely responsible for compliance with all legal, regulatory and safety-related requirements concerning its products, and any use of TI components in its applications, notwithstanding any applications-related information or support that may be provided by TI. Buyer represents and agrees that it has all the necessary expertise to create and implement safeguards which anticipate dangerous consequences of failures, monitor failures and their consequences, lessen the likelihood of failures that might cause harm and take appropriate remedial actions. Buyer will fully indemnify TI and its representatives against any damages arising out of the use of any TI components in safety-critical applications.

In some cases, TI components may be promoted specifically to facilitate safety-related applications. With such components, TI's goal is to help enable customers to design and create their own end-product solutions that meet applicable functional safety standards and requirements. Nonetheless, such components are subject to these terms.

No TI components are authorized for use in FDA Class III (or similar life-critical medical equipment) unless authorized officers of the parties have executed a special agreement specifically governing such use.

Only those TI components which TI has specifically designated as military grade or "enhanced plastic" are designed and intended for use in military/aerospace applications or environments. Buyer acknowledges and agrees that any military or aerospace use of TI components which have **not** been so designated is solely at the Buyer's risk, and that Buyer is solely responsible for compliance with all legal and regulatory requirements in connection with such use.

TI has specifically designated certain components as meeting ISO/TS16949 requirements, mainly for automotive use. In any case of use of non-designated products, TI will not be responsible for any failure to meet ISO/TS16949.

Products

Audio	www.ti.com/audio
Amplifiers	amplifier.ti.com
Data Converters	dataconverter.ti.com
DLP® Products	www.dlp.com
DSP	dsp.ti.com
Clocks and Timers	www.ti.com/clocks
Interface	interface.ti.com
Logic	logic.ti.com
Power Mgmt	power.ti.com
Microcontrollers	microcontroller.ti.com
RFID	www.ti-rfid.com
OMAP Applications Processors	www.ti.com/omap
Wireless Connectivity	www.ti.com/wirelessconnectivity

Applications

Automotive and Transportation	www.ti.com/automotive
Communications and Telecom	www.ti.com/communications
Computers and Peripherals	www.ti.com/computers
Consumer Electronics	www.ti.com/consumer-apps
Energy and Lighting	www.ti.com/energy
Industrial	www.ti.com/industrial
Medical	www.ti.com/medical
Security	www.ti.com/security
Space, Avionics and Defense	www.ti.com/space-avionics-defense
Video and Imaging	www.ti.com/video

TI E2E Community

e2e.ti.com