

Test Report:

PMP22220 1500-W AC Switch Bridgeless PFC Reference Design



Description

This reference design is an AC switch bridgeless power factor correction (PFC) operates with continuous conduction mode (CCM). It takes universal AC-input voltage (90 VAC to 264 VAC), provides 390-V, 1000-W low-line output and 1500 W high-line output. This design uses the UCD3138 digital controller and UCC21220 isolated gate driver. This design achieves 97.1% peak efficiency at 115-VAC input and 98.3% peak efficiency at 230-VAC input. The total harmonic distortion (THD) is less than 1.2% at 115 VAC, 1000 W and less than 2% at 230 VAC, 1500 W. The power factor is greater than 0.997 for both 115 VAC and 230 VAC at full load.

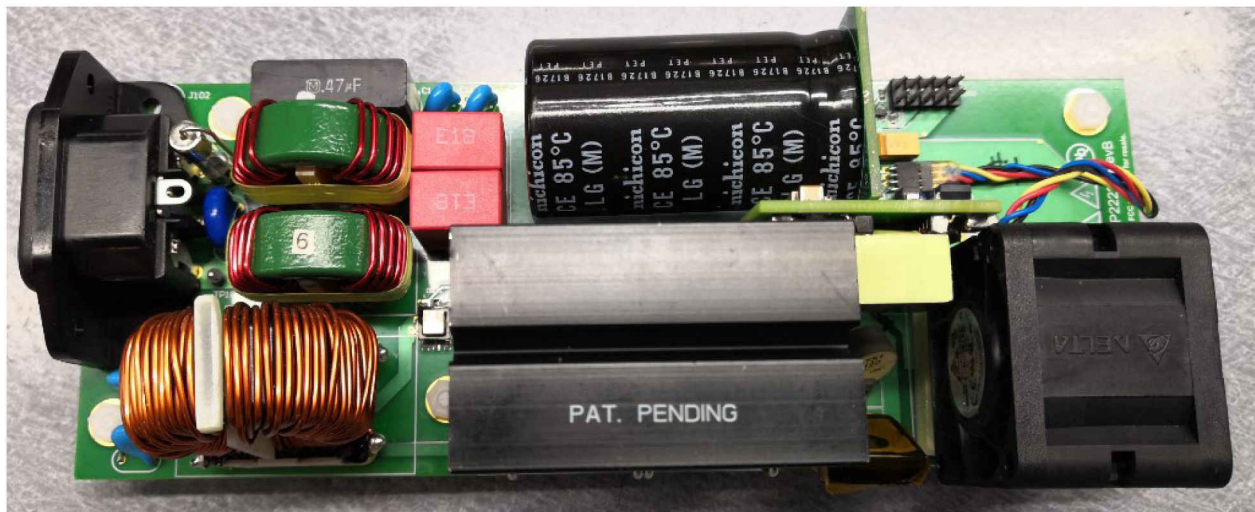
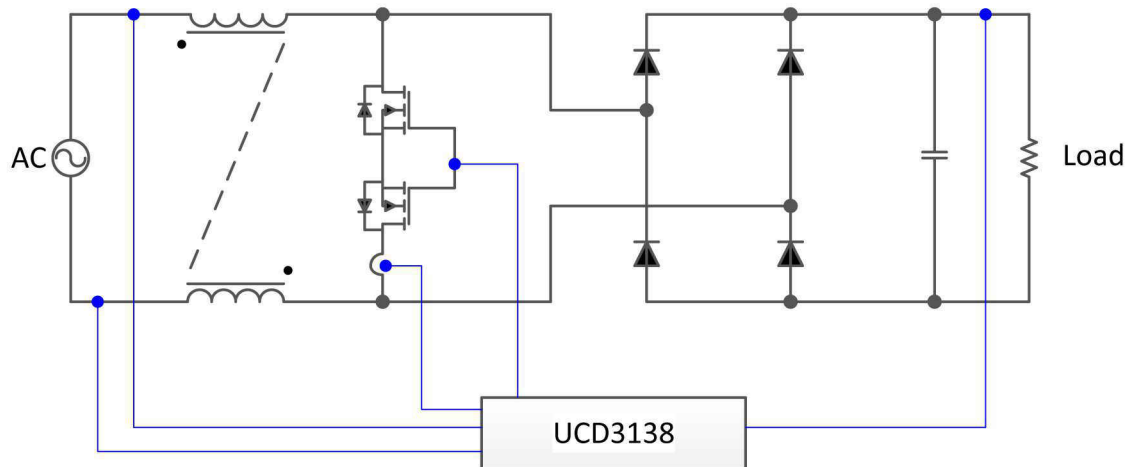

1 System Specification

1.1 Board Dimension:

185mm x 69mm x 45mm (L x W x H) (Not include MP100).

1.2 Input Characteristics

Parameter	Conditions	Min	TYP	MAX	Units
Input Voltage	Normal Operating	90		264	V
Input Current	115Vac and 1000W load		9.06		A
	230Vac and 1500W load		6.67		A
AC Frequency		47		63	Hz
Inrush current	260Vac at 90 degree phase		12		A

1.3 Output Characteristics

Parameter	Conditions	Min	TYP	MAX	Units
Output Voltage			390		V
Output power	230Vac input			1500	W
	115Vac input			1000	W
	100Vac input			900	W
	90Vac input			800	W
Output Ripple(low frequency peak to peak)	1000W @ 115Vac		20		V
	1500W @ 230Vac		28		V
Over Current Protection	Cycle-by-cycle current limit (peak)		20		A
Over Voltage Protection	Shut down and latch		430		V
	Hiccup between 370V and 420V		420		V
Switching frequency	Single phase		75		KHz

2 Testing and Results

2.1 Board Photos

The photographs below show the top and bottom view of the PMP22220 board. A separate bias daughter card PMP22459 is plugged in PMP22220 to provide bias supplies.

2.1.1 Top Side

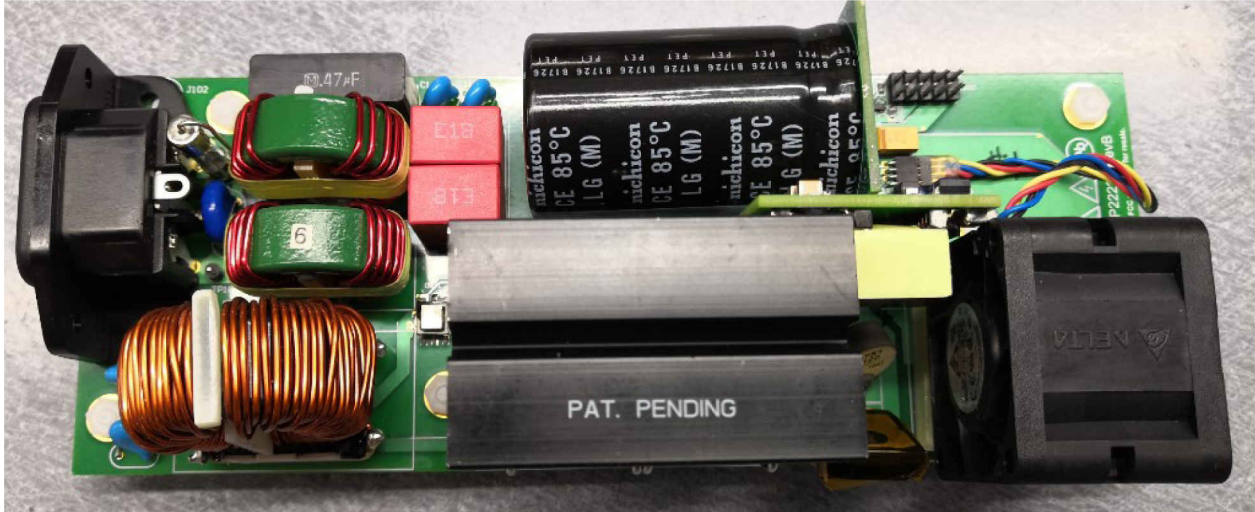

2.1.2 Bottom Side

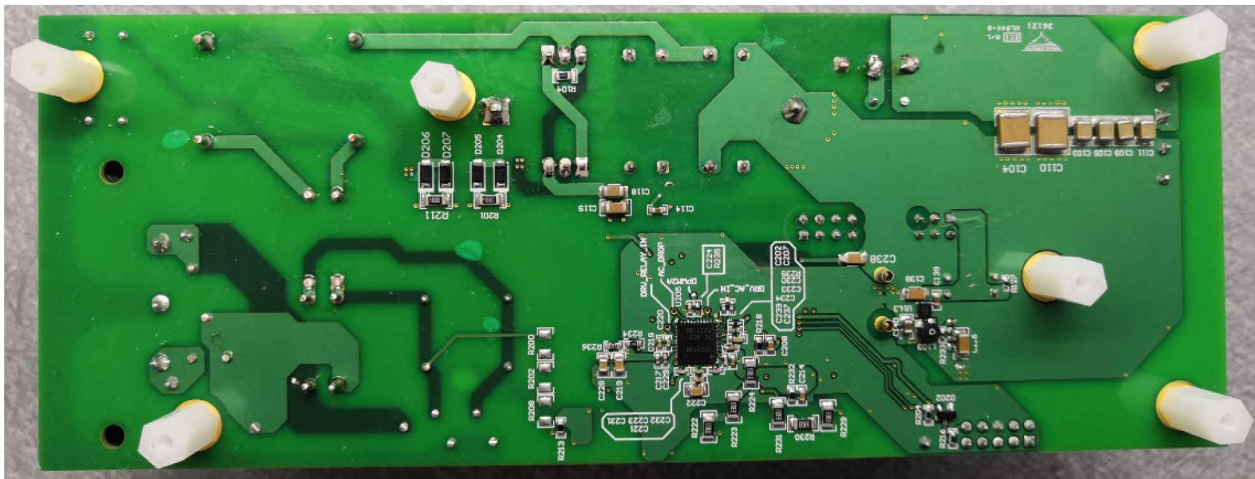

2.2 Efficiency Data

Peak efficiency: 97.1% @ 115VAC/60Hz and 98.3% @ 230VAC/50Hz

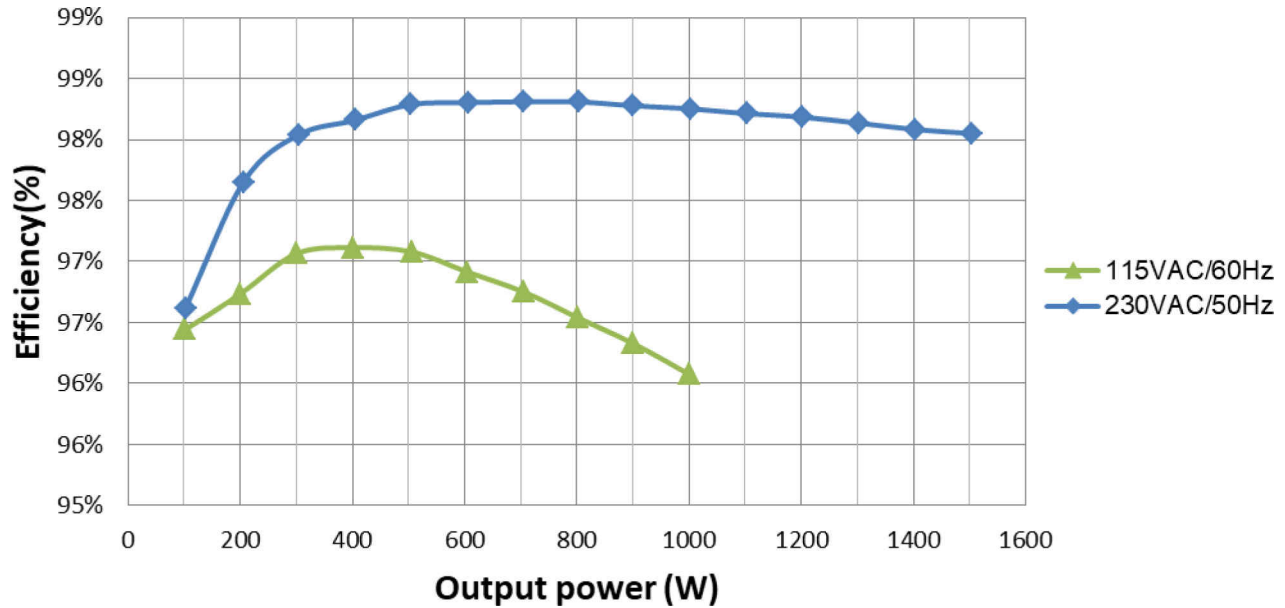

2.2.1 115V_{AC}/60Hz Efficiency Measurement Data (without Bias)

115VAC/60Hz		
Pin(W)	Pout(W)	Efficiency (%)
105.68	101.92	96.44%
206.29	199.55	96.73%
309.31	300.23	97.06%
414.05	402.1	97.11%
520.5	505.3	97.08%
623.91	604.66	96.91%
728.27	704.61	96.75%
829.32	800.64	96.54%
934.56	900.25	96.33%
1041.46	1000.57	96.07%

2.2.2 230V_{AC}/50Hz Efficiency Measurement Data (without Bias)

230VAC/50Hz		
Pin(W)	Pout(W)	Efficiency (%)
106.16	102.57	96.62%
210.79	205.84	97.65%
310.12	304.04	98.04%
412.96	405.36	98.16%
512.61	503.83	98.29%
616.68	606.21	98.30%
716.68	704.57	98.31%
817.58	803.75	98.31%
915.36	899.59	98.28%
1020.94	1003.09	98.25%
1122.83	1102.76	98.21%
1225.22	1202.97	98.18%
1327.74	1302.98	98.14%
1430.99	1403.56	98.08%
1533.34	1503.44	98.05%

2.3 THD and PF

THD

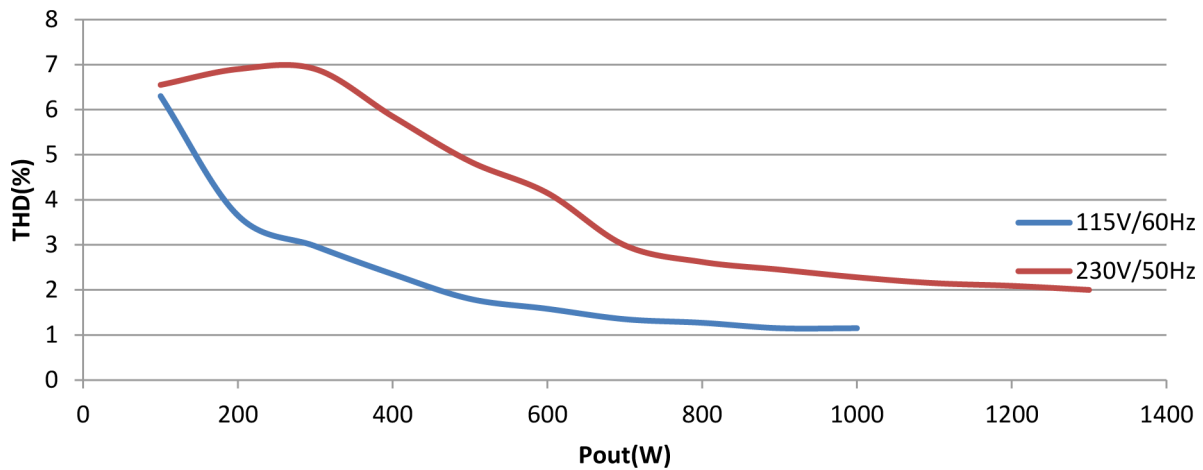

PF

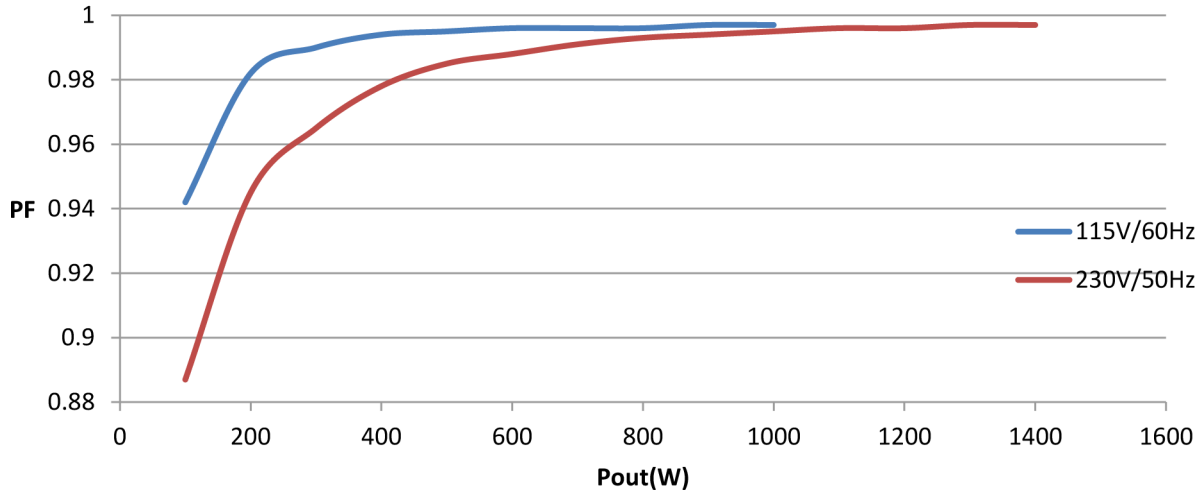

Vin	load(W)	THD(%)	PF
115V/60Hz	100	6.3	0.942
	200	3.65	0.982
	300	2.97	0.99
	400	2.35	0.994
	500	1.8	0.995
	600	1.58	0.996
	700	1.35	0.996
	800	1.27	0.996
	900	1.15	0.997
	1000	1.15	0.997
230/50	100	6.55	0.887
	200	6.9	0.945
	300	6.9	0.965
	400	5.85	0.978
	500	4.85	0.985
	600	4.15	0.988
	700	2.99	0.991
	800	2.62	0.993
	900	2.45	0.994
	1000	2.28	0.995
	1100	2.15	0.996
	1200	2.09	0.996
	1300	2	0.997
	1400	1.95	0.997

2.4 Thermal Images

The thermal images below show a top view, front view and MOSFET view of the board. The ambient temperature was 25°C.

2.4.1 115V_{AC}/60Hz, 1000W, Top

Measurements		
Bx1	Max	41.0 °C
Bx2	Max	49.9 °C
	Min	29.2 °C
	Average	43.4 °C
Bx3	Max	37.1 °C
	Min	33.7 °C
	Average	35.6 °C
Sp1		24.9 °C
Parameters		
Emissivity		0.98
Refl. temp.		20 °C

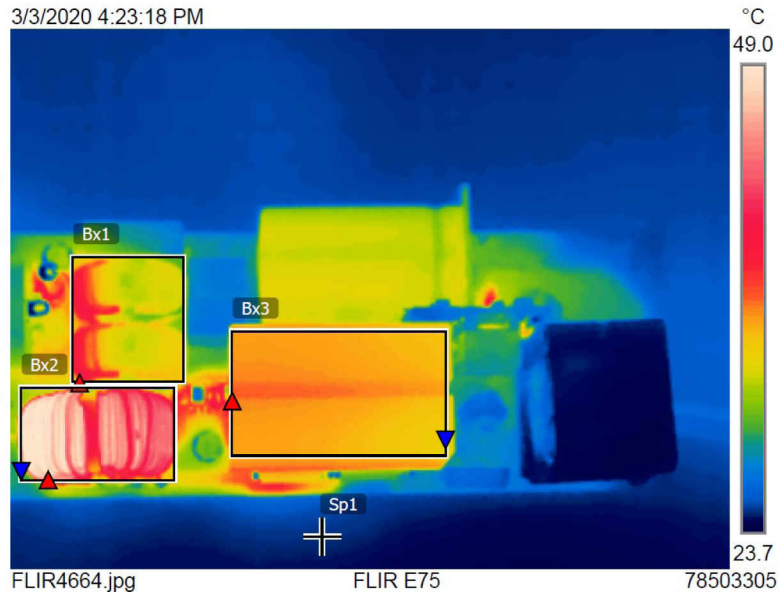

2.4.2 115V_{AC}/60Hz, 1000W, Side

Measurements		
Bx1	Max	51.3 °C
Bx2	Max	59.2 °C
	Min	23.7 °C
	Average	37.2 °C
Bx3	Max	59.7 °C
	Min	32.2 °C
	Average	39.9 °C
Sp1		24.2 °C
Parameters		
Emissivity		0.98
Refl. temp.		20 °C

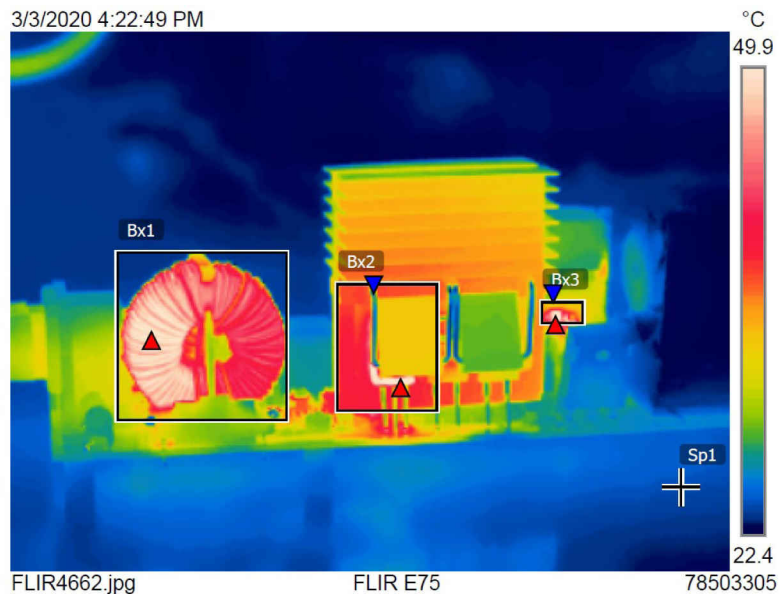

2.4.3 115V_{AC}/60Hz, 1000W, Mosfet

Measurements

Bx1	Max	50.8 °C
Bx2	Max	74.2 °C
	Min	23.7 °C
	Average	41.5 °C
Sp1		24.1 °C

Parameters

Emissivity	0.98
Refl. temp.	20 °C

3/3/2020 4:22:30 PM

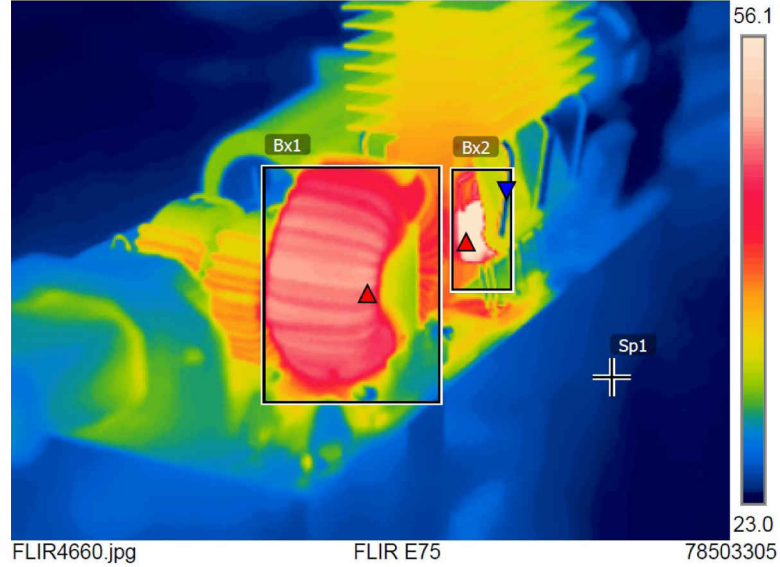

2.4.4 230V_{AC}/50Hz, 1500W, Top

Measurements

Bx1	Max	34.6 °C
Bx2	Max	40.1 °C
	Min	27.8 °C
	Average	36.5 °C
Bx3	Max	35.4 °C
	Min	33.0 °C
	Average	34.3 °C
Sp1		24.7 °C

Parameters

Emissivity	0.98
Refl. temp.	20 °C

3/3/2020 3:59:45 PM

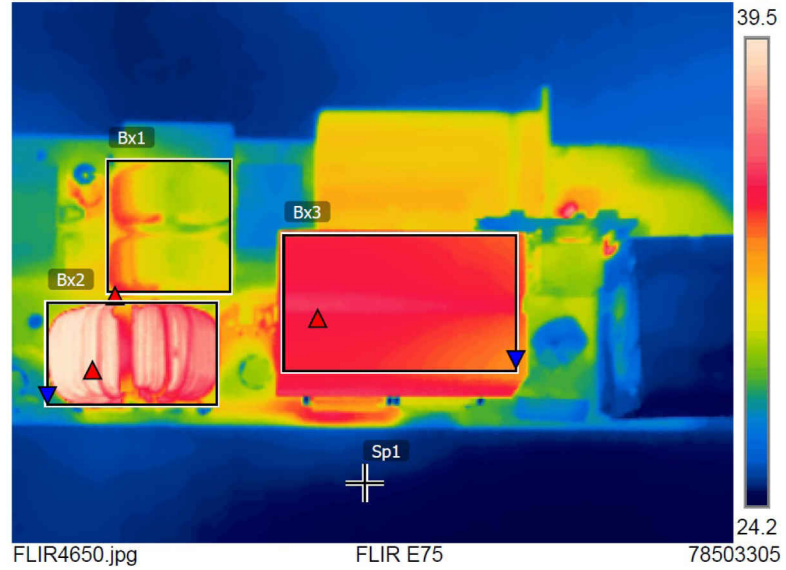

2.4.5 230V_{AC}/50Hz, 1500W, Side

Measurements

Bx1	Max	41.7 °C
Bx2	Max	45.7 °C
	Min	23.9 °C
	Average	34.4 °C
Bx3	Max	63.7 °C
	Min	31.1 °C
	Average	39.1 °C

Parameters

Emissivity	0.98
Refl. temp.	20 °C

3/3/2020 4:02:31 PM

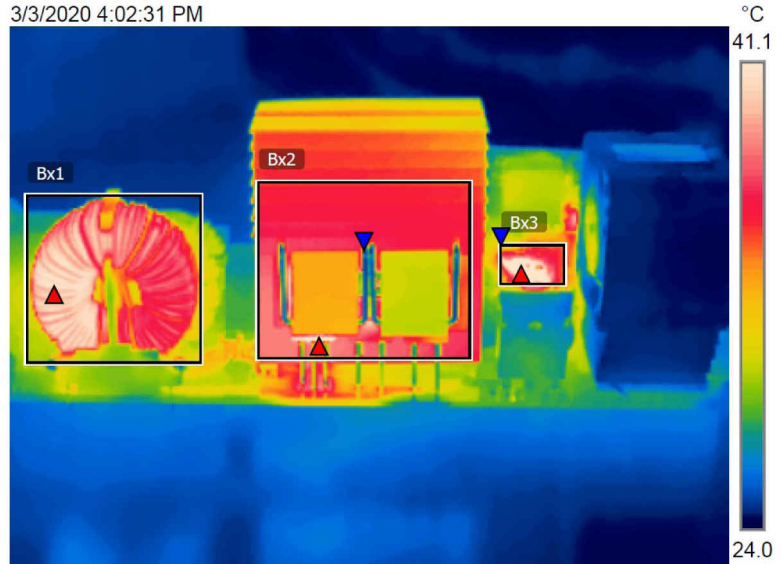

FLIR4652.jpg

FLIR E75

78503305

2.4.6 230V_{AC}/50Hz, 1500W, MOSFET

Measurements

Bx1	Max	41.3 °C
Bx2	Max	56.7 °C
	Min	24.7 °C
	Average	36.9 °C
Sp1		25.7 °C

Parameters

Emissivity	0.98
Refl. temp.	20 °C

3/3/2020 4:03:10 PM

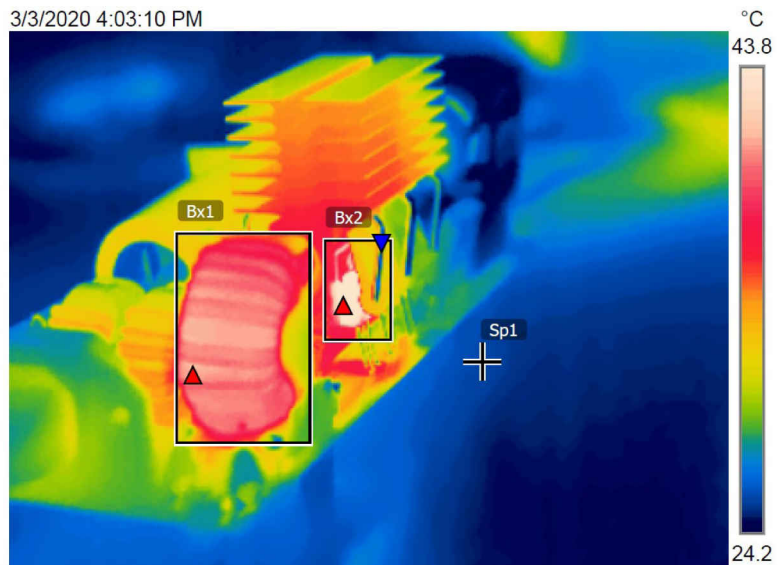

FLIR4654.jpg

FLIR E75

78503305

2.5 Startup

In the following waveforms, Channel 1 is output voltage

2.5.1 115V_{AC}/60Hz – No Load

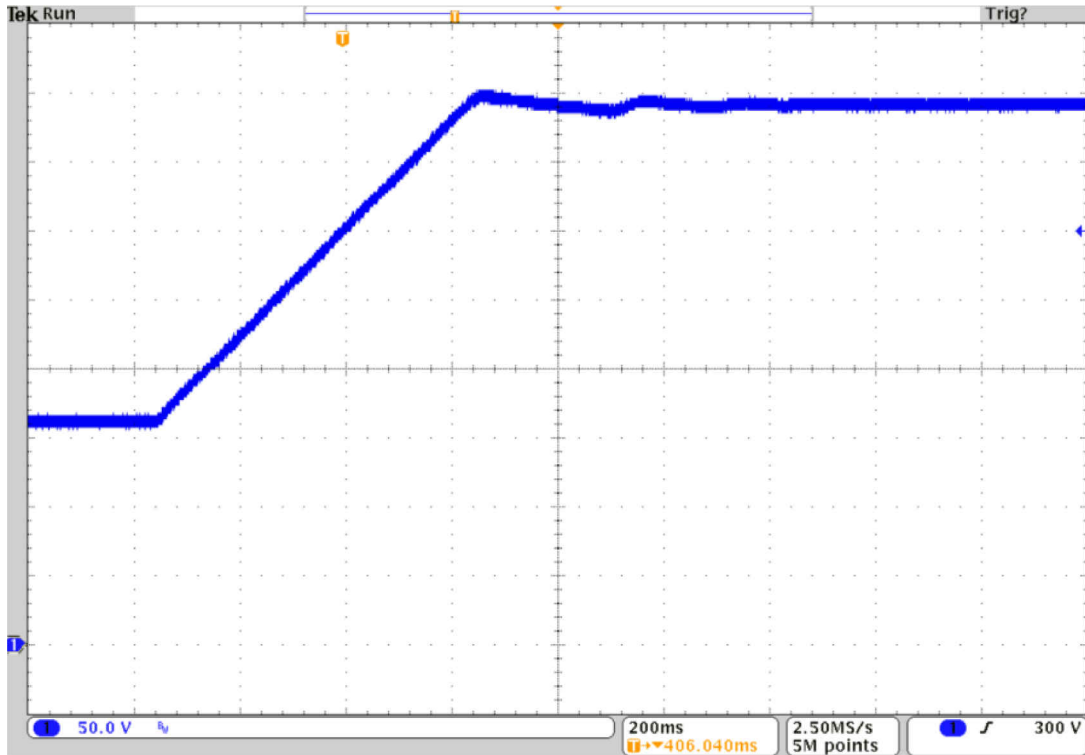

2.5.2 115V_{AC}/60Hz 200W

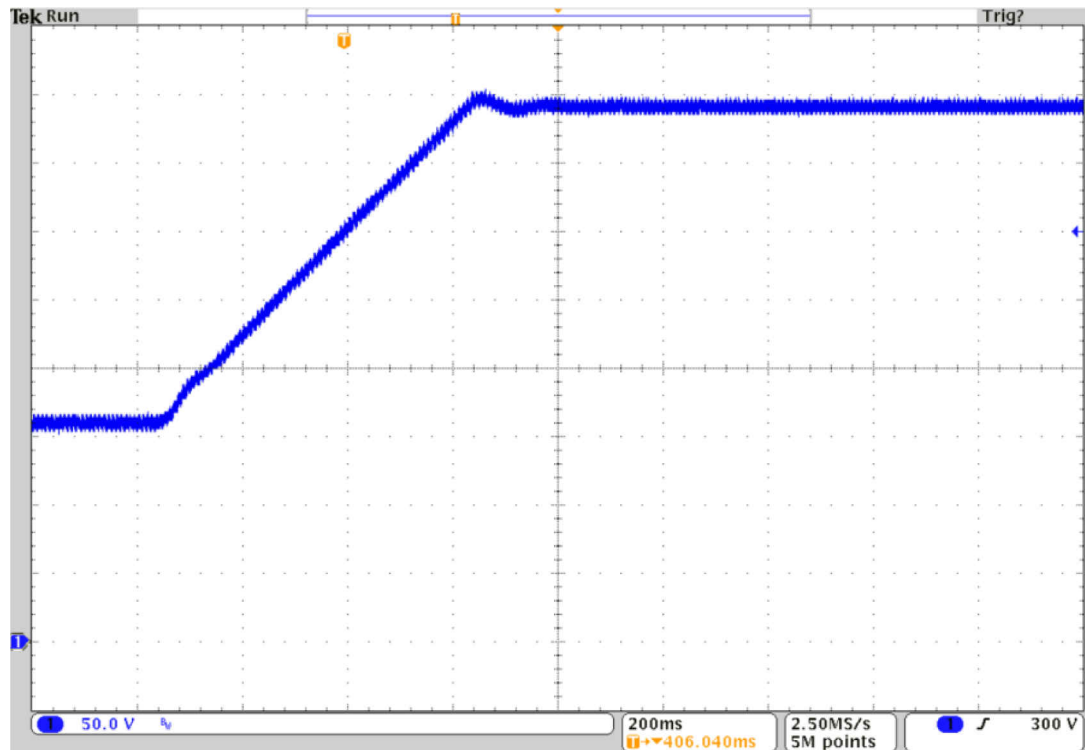

2.5.3 230V_{AC}/50Hz – No Load

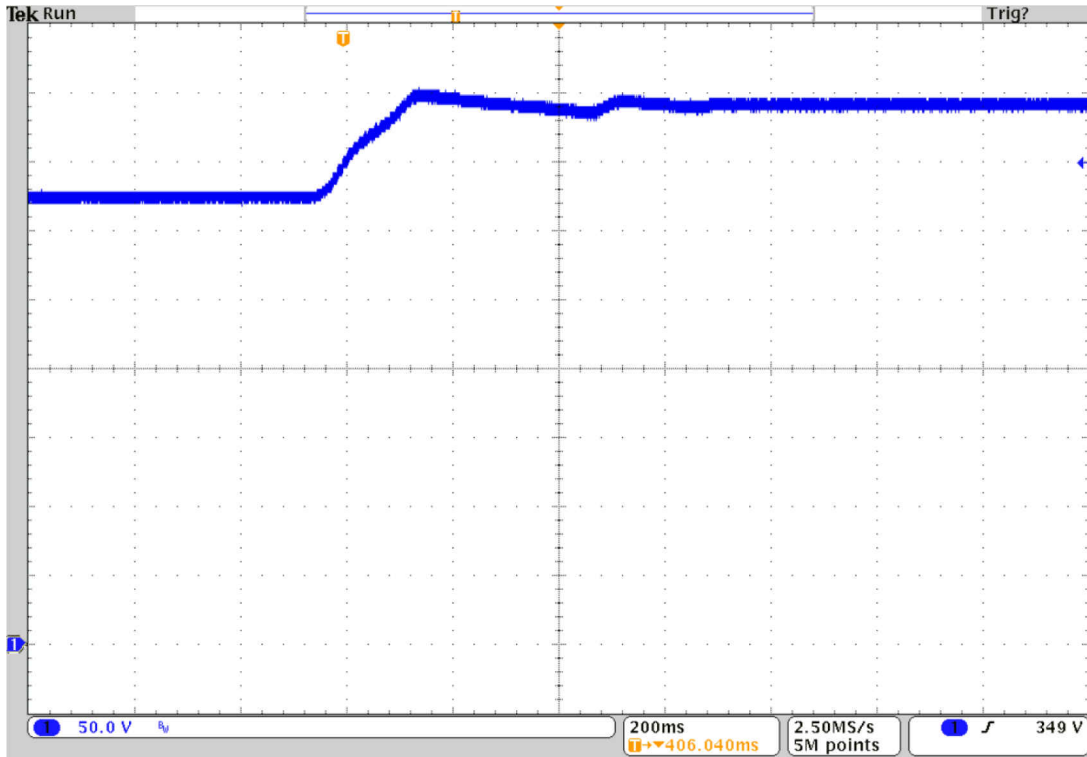

2.5.4 230V_{AC}/50Hz 200W

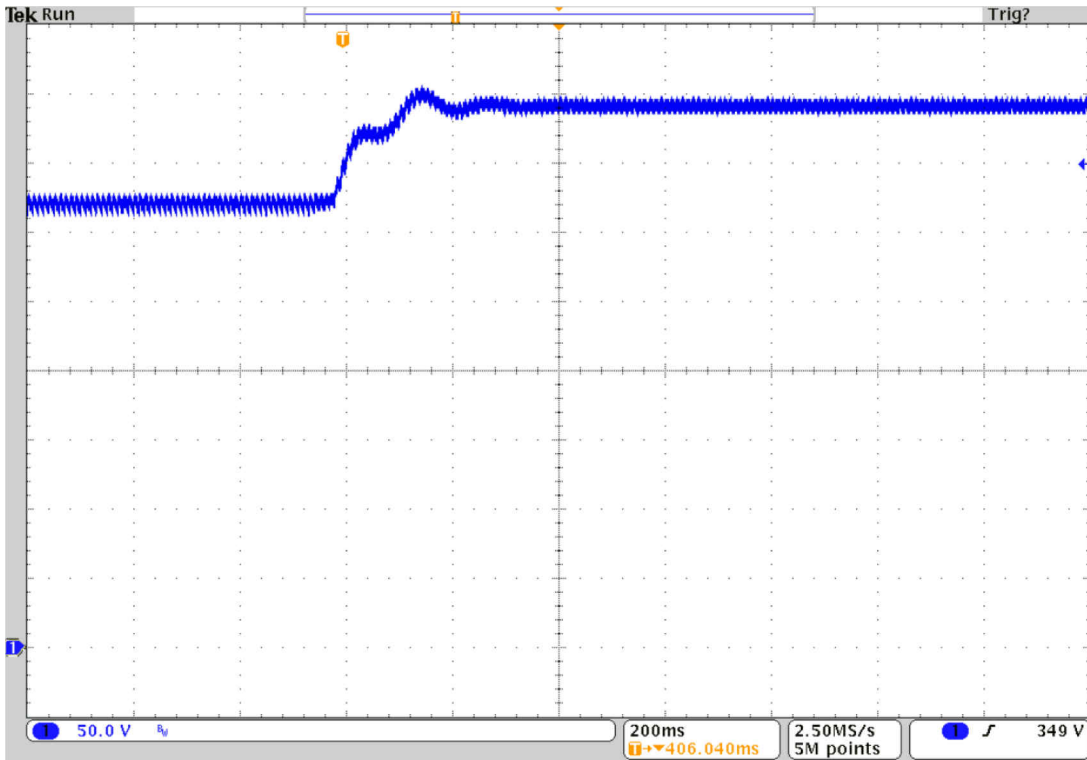

2.6 Input Current Waveform

In the following waveforms, Channel 3 is input current, Channel 4 is input voltage

2.6.1 115V_{AC}/60Hz 500W

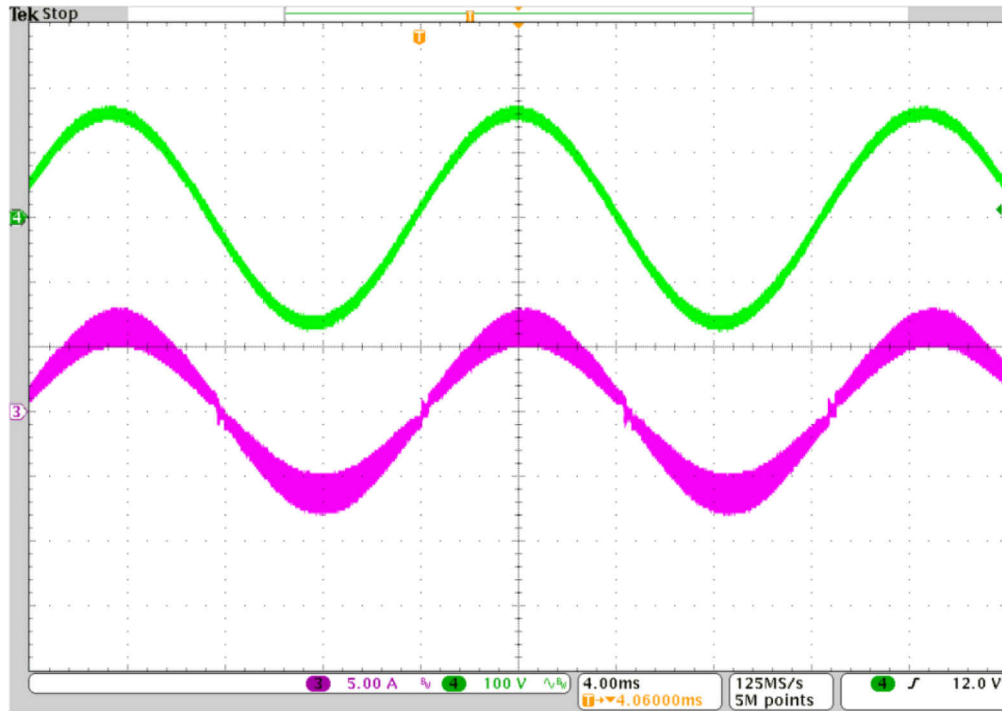

2.6.2 115V_{AC}/60Hz 1000W

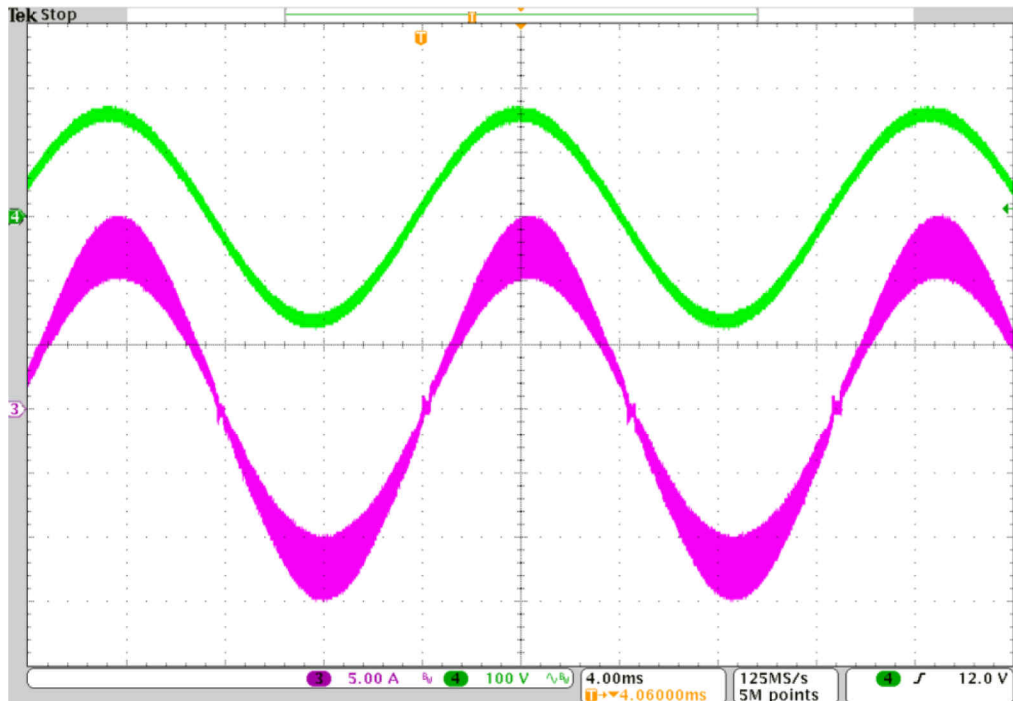

2.6.3 230V_{AC}/50Hz 750W

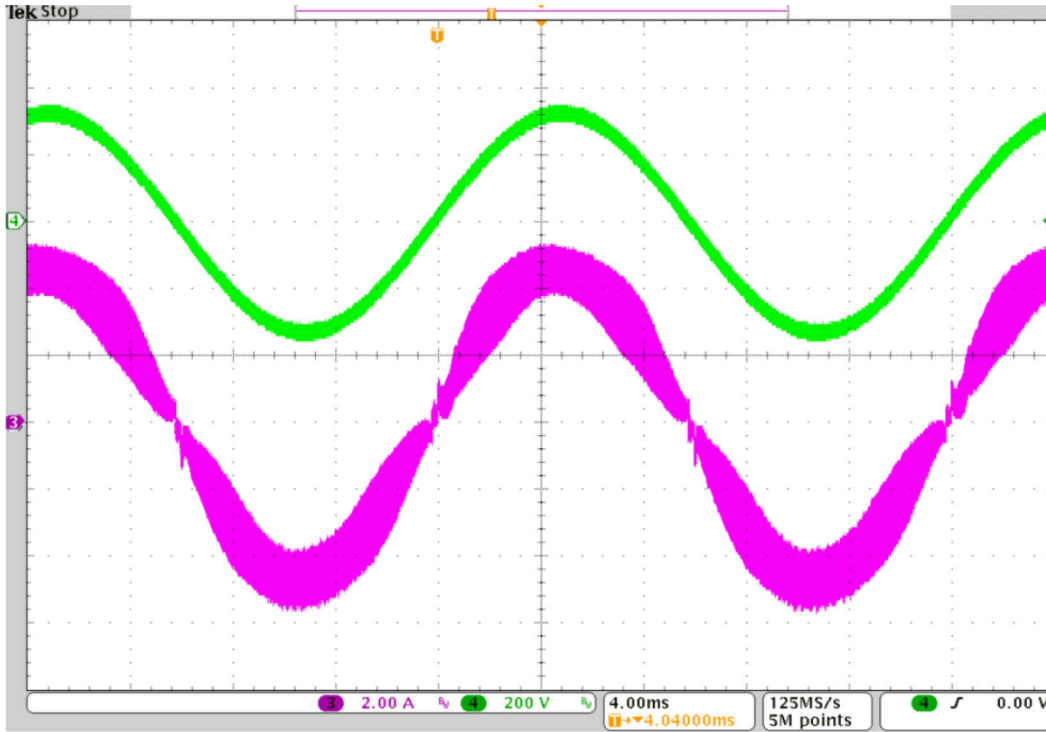

2.6.4 230V_{AC}/50Hz 1500W

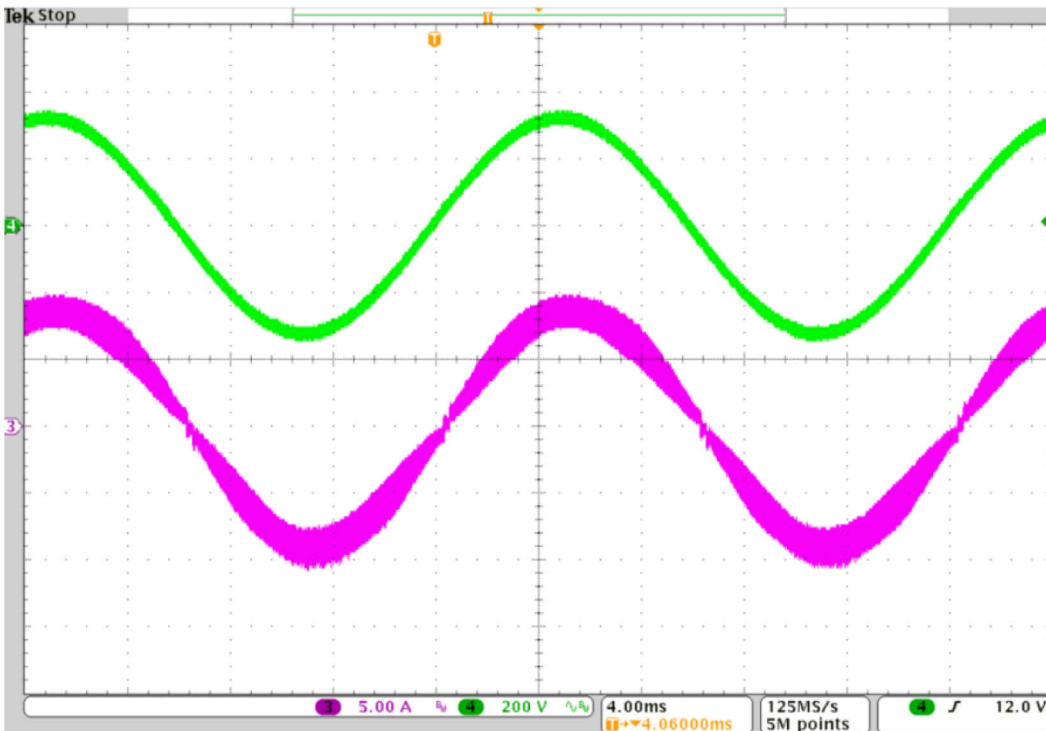

2.7 Load Transient

In the following waveforms, Channel 1 is output voltage, Channel 2 is output current, Channel 3 is input current

2.7.1 115V_{AC}/60Hz 0W -> 1000W

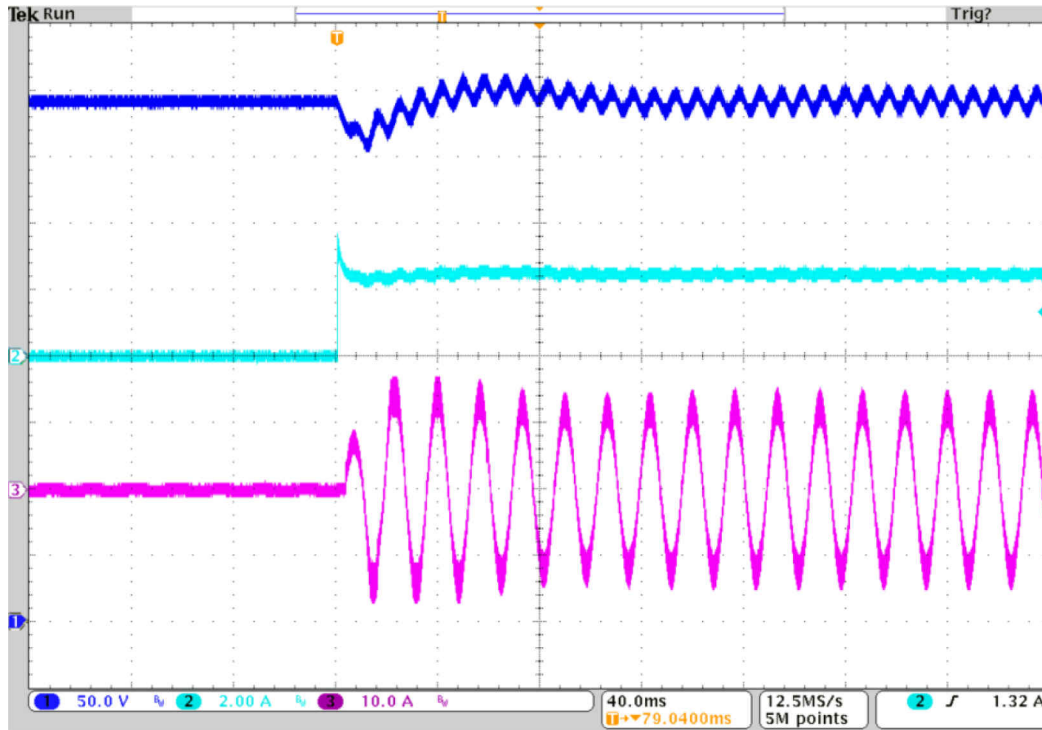

2.7.2 115V_{AC}/60Hz 1000W -> 0W

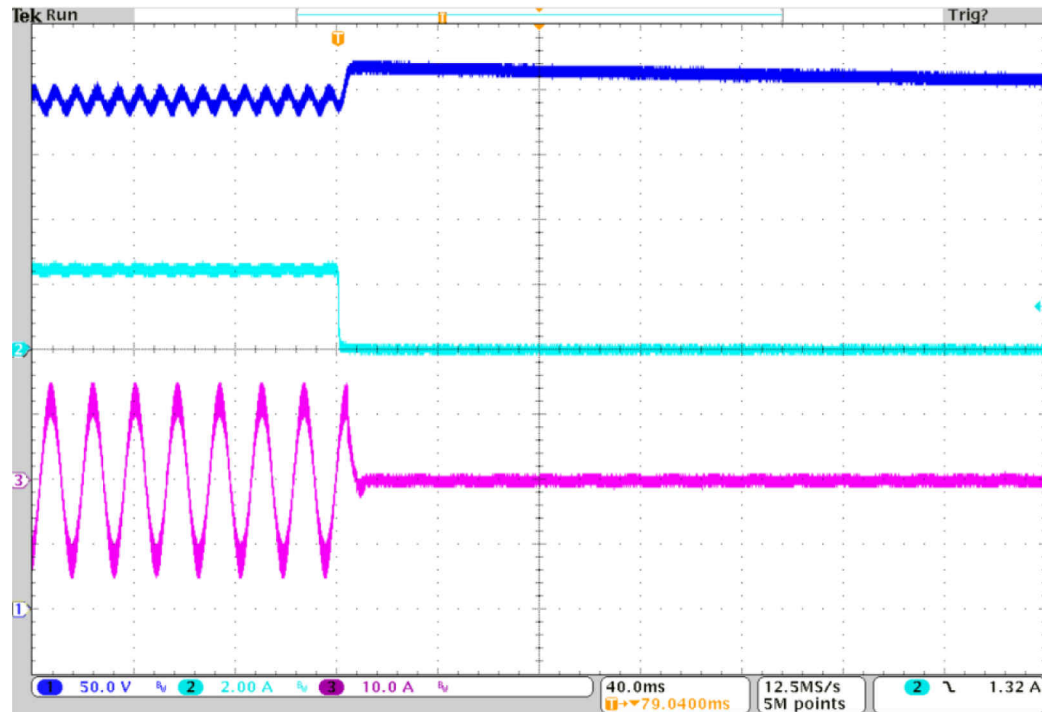

2.7.3 230V_{AC}/50Hz 0W -> 1000W

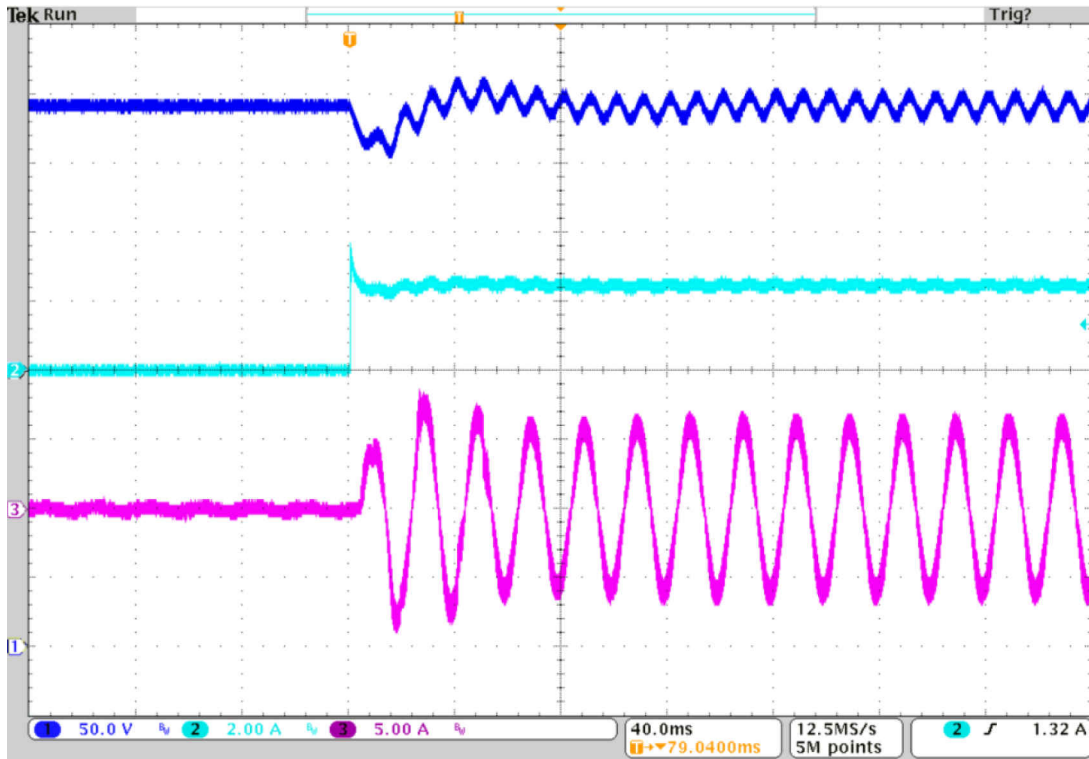

2.7.4 230V_{AC}/50Hz 1000W -> 0W

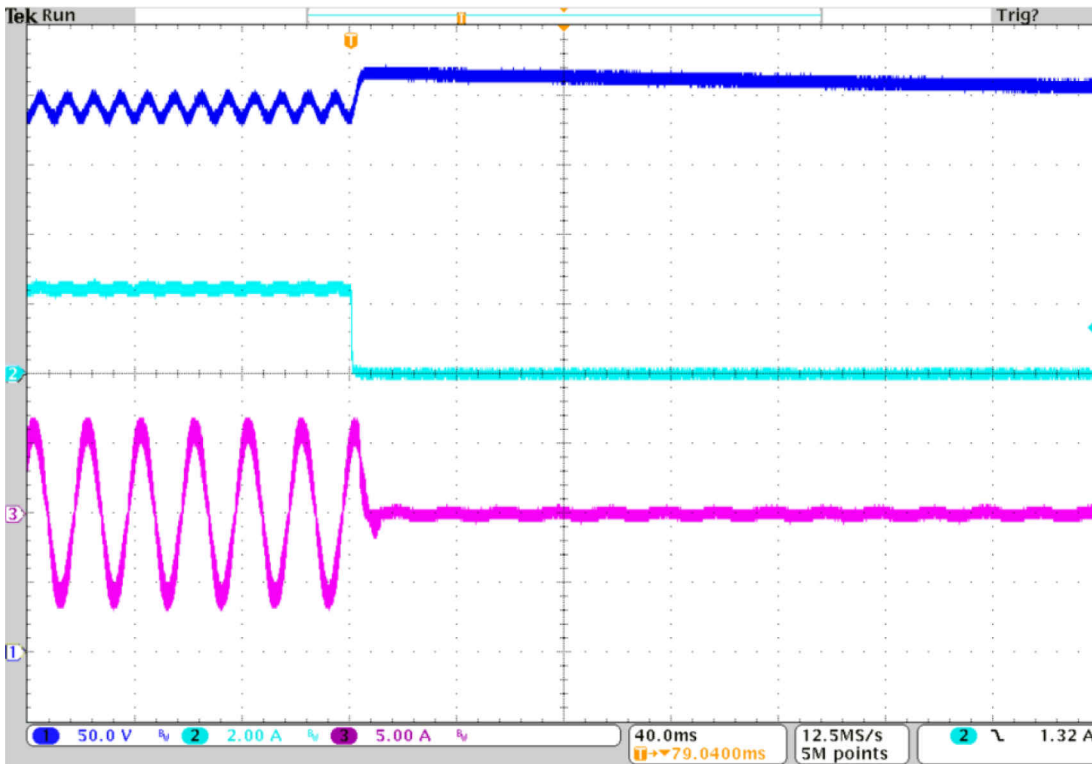

2.8 Line Transient

In the following waveforms, Channel 1 is output voltage, Channel 3 is input current, Channel 4 is input voltage

2.8.1 230V_{AC} → 115V_{AC} 700W

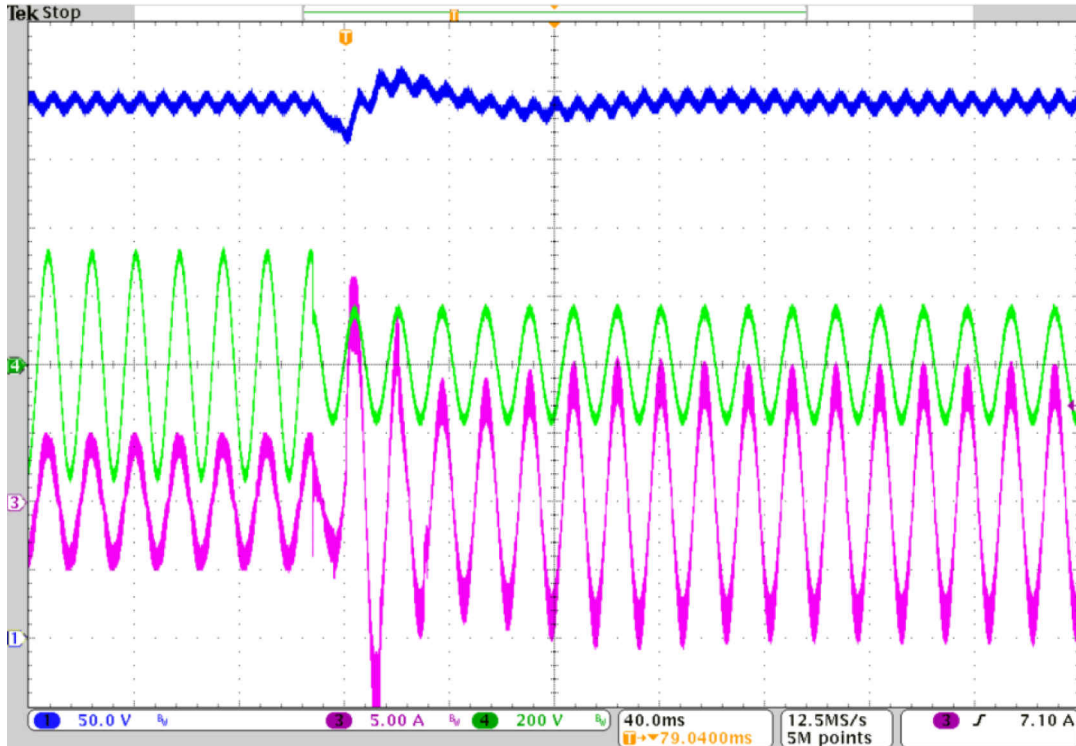

2.8.2 115V_{AC} → 230V_{AC} 700W

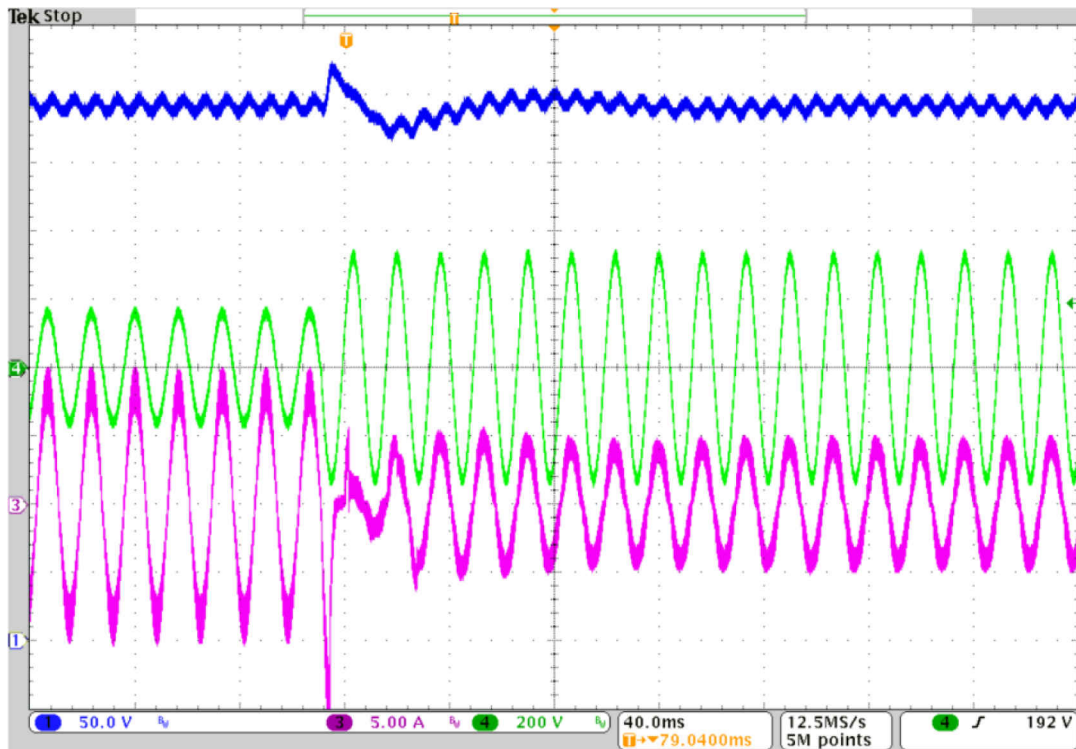

2.8.3 230V_{AC} → 115V_{AC} 0W

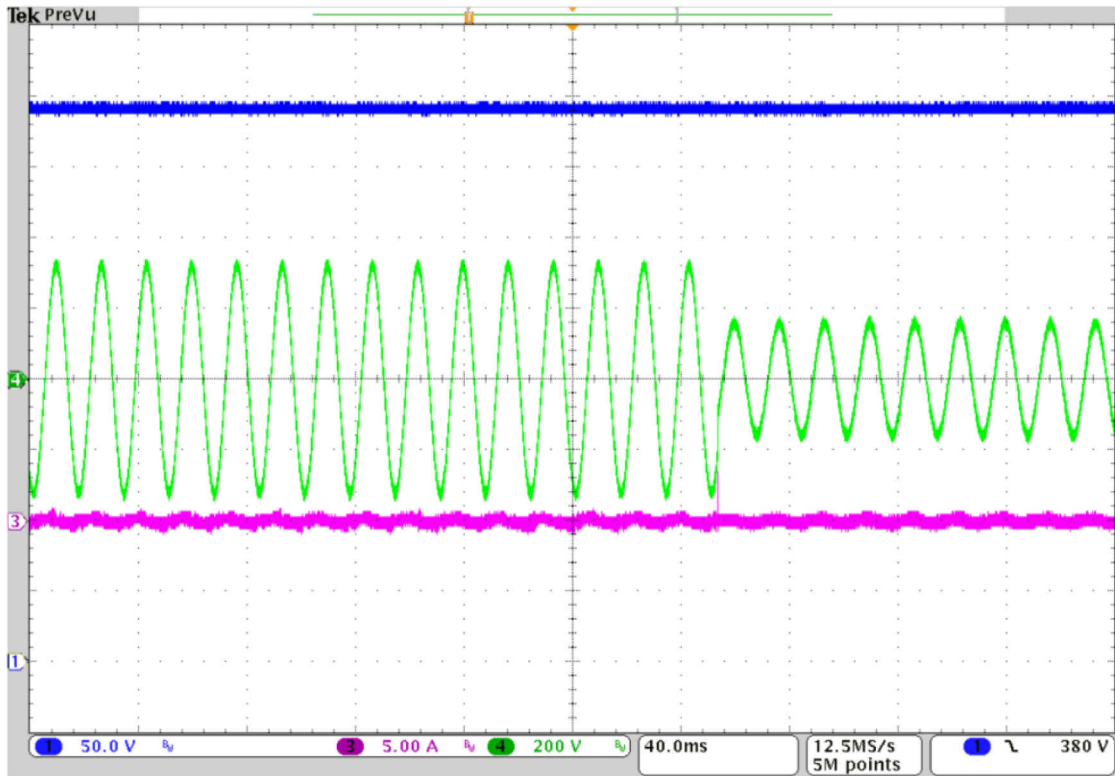

2.8.4 115V_{AC} → 230V_{AC} 0W

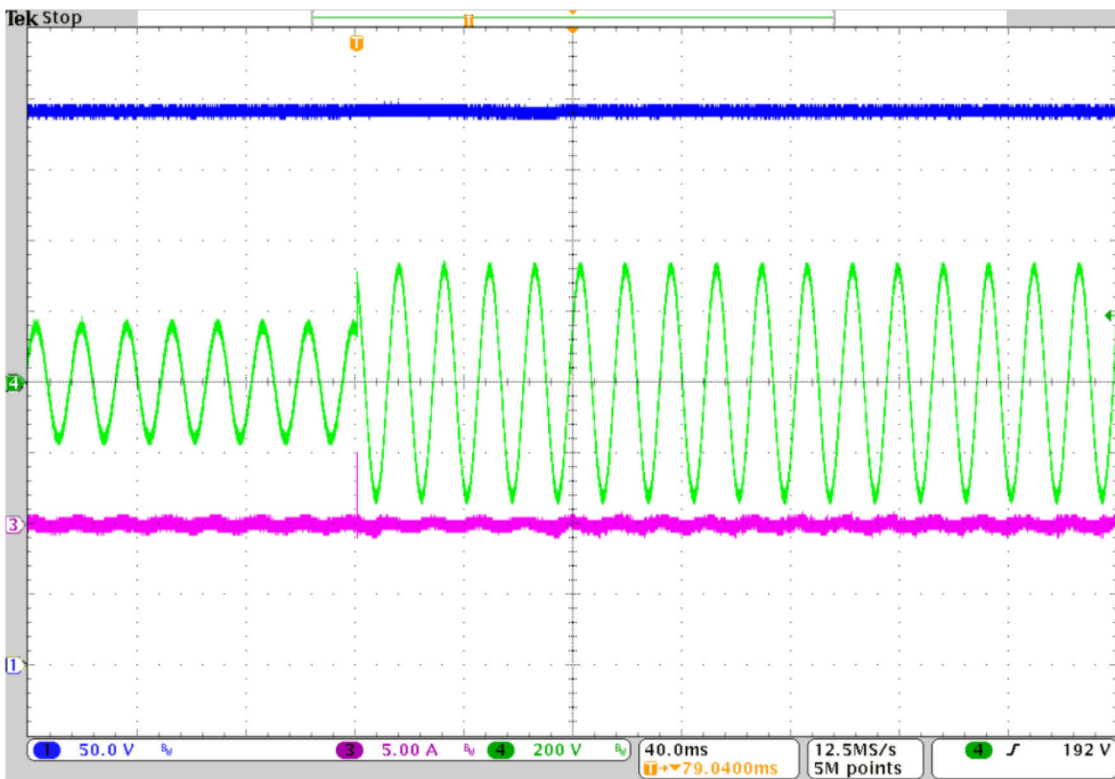

2.9 AC Frequency Transient

In the following waveforms, Channel 1 is output voltage, Channel 3 is input current, Channel 4 is input voltage

2.9.1 47Hz -> 63Hz 1000W

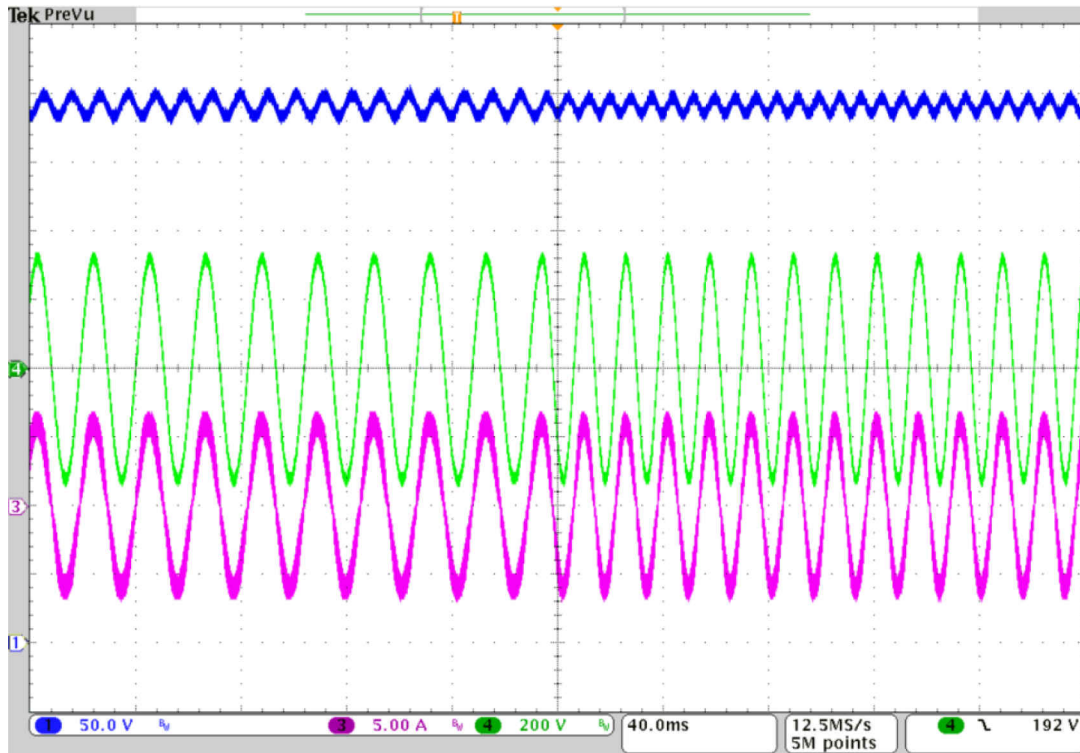

2.9.2 63Hz -> 47Hz 1000W

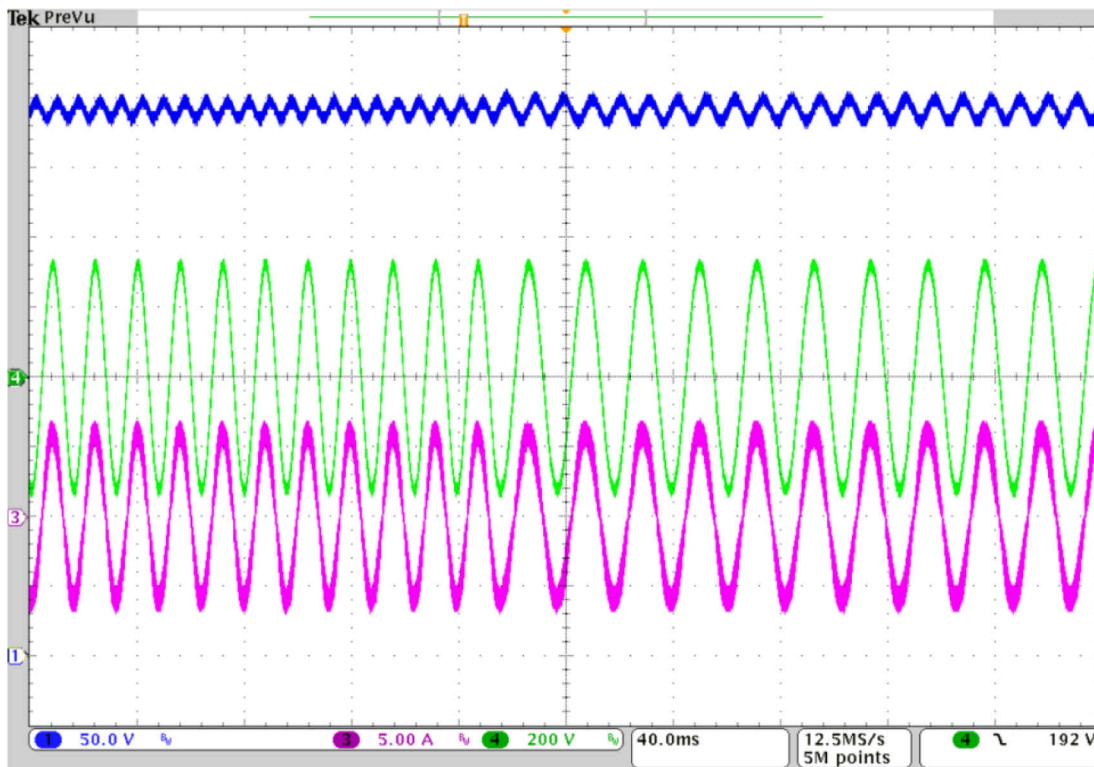

2.10 About the Authors

Bosheng Sun is a Systems Application Engineer at Texas Instruments, where he is responsible for responsible for core systems and application engineering activities for TI digital power controllers. Bosheng received his MS degree in Electrical Engineering from the Cleveland State University in 2003.

Sheng-Yang Yu is an Application Engineer at Texas Instruments, where he is responsible for developing power supply reference design solutions for strategic customers. Sheng-Yang earned his PhD in Electrical Engineering from the University of Texas at Austin in 2012.

IMPORTANT NOTICE AND DISCLAIMER

TI PROVIDES TECHNICAL AND RELIABILITY DATA (INCLUDING DATA SHEETS), DESIGN RESOURCES (INCLUDING REFERENCE DESIGNS), APPLICATION OR OTHER DESIGN ADVICE, WEB TOOLS, SAFETY INFORMATION, AND OTHER RESOURCES "AS IS" AND WITH ALL FAULTS, AND DISCLAIMS ALL WARRANTIES, EXPRESS AND IMPLIED, INCLUDING WITHOUT LIMITATION ANY IMPLIED WARRANTIES OF MERCHANTABILITY, FITNESS FOR A PARTICULAR PURPOSE OR NON-INFRINGEMENT OF THIRD PARTY INTELLECTUAL PROPERTY RIGHTS.

These resources are intended for skilled developers designing with TI products. You are solely responsible for (1) selecting the appropriate TI products for your application, (2) designing, validating and testing your application, and (3) ensuring your application meets applicable standards, and any other safety, security, regulatory or other requirements.

These resources are subject to change without notice. TI grants you permission to use these resources only for development of an application that uses the TI products described in the resource. Other reproduction and display of these resources is prohibited. No license is granted to any other TI intellectual property right or to any third party intellectual property right. TI disclaims responsibility for, and you will fully indemnify TI and its representatives against, any claims, damages, costs, losses, and liabilities arising out of your use of these resources.

TI's products are provided subject to [TI's Terms of Sale](#) or other applicable terms available either on [ti.com](https://www.ti.com) or provided in conjunction with such TI products. TI's provision of these resources does not expand or otherwise alter TI's applicable warranties or warranty disclaimers for TI products.

TI objects to and rejects any additional or different terms you may have proposed.

Mailing Address: Texas Instruments, Post Office Box 655303, Dallas, Texas 75265
Copyright © 2023, Texas Instruments Incorporated