



TI reference design number: PMP9367 Rev A1

**Input: 6-40V
Nominal 12V**

Output: 5V @ 3.5A

(USB CH 1: 5V @ 1A)

(USB CH 2: 5V @ 2.1A)

DC-DC Converter Test Results

Table of Contents

1. Circuit Description	3
2. Fabrication	3
2.1 Block Diagram	5
3. Efficiency	6
4. Load Regulation	6
5. Thermal	8
Top View.....	8
6. Power Up USB CH1	9
6.1 Power Up at 6V Input – No Load Power Up at 6V Input –1A Load.....	9
6.2 Power Up at 12V Input – No Load Power Up at 12V Input –1A Load.....	9
6.3 Power Up at 36V Input – No Load Power Up at 36V Input –1A Load.....	10
Power Up USB CH2.....	11
6.4 Power Up at 6V Input – No Load Power Up at 6V Input –2.1A Load.....	11
6.5 Power Up at 12V Input – No Load Power Up at 12V Input –2.1A Load.....	11
6.6 Power Up at 36V Input – No Load Power Up at 12V Input –2.1A Load.....	12
7. Switching and Ripple.....	13
7.1 LM3150 5VOUT @ 3.1A.....	13
8. Transient Response	14
8.1 12V Input – 0.5A to 1A Step, 100mA/μs, 100 Hz. USB Ch1	14
8.2 12V Input – 1.05A to 2.1A Step, 100mA/μs, 100 Hz. USB Ch2	14
9. Current Limit Tests 12V Input.....	15
9.1 LM3150.....	15
-12Vin - No Load -12Vin - 3.5A Load	15
9.2 USB CH1	15
-12Vin - No Load -12Vin - 1A Load	15
9.3 USB CH2	16
-12V in - No Load -12Vin - 2.1A Load	16
10.1 Short Circuit Tests.....	17
10.1 12Vin, LM3150 No Load 12Vin, LM3150 3.1A Load	17
10.2 12Vin, USB CH1 No Load 12Vin, USB CH1 1A Load	17
10.3 12Vin, USB CH2 No Load 12Vin, USB CH2 2.1A Load	18
11. Short Circuit Recovery Tests.....	19
11.1 12Vin, LM3150 No Load 12Vin, LM3150 3.1A Load	19
11.2 12Vin, USB CH1 No Load 12Vin, USB CH1 1A Load	19
11.3 12Vin, USB CH2 No Load 12Vin, USB CH2 2.1A Load	20

1. Circuit Description

PMP9367 is a dual USB car charger. This design utilizes the LM3150, TPS2561 Dual Channel Power Switch and a TPS2513 USB Dedicated Charging Port Controller. This design operates from 6 to 40V in. The outputs is set to 5V, channel one has a 1A current limit and channel two has a 2.1A current limit. This design has a switching frequency of 300 kHz.

2. Fabrication

The PMP9367 is a four layer board with overall dimensions of 0.713" (18mm) x 2.2" (55mm). The copper weight is 1oz on the outer layers and 0.5oz the inner layers.

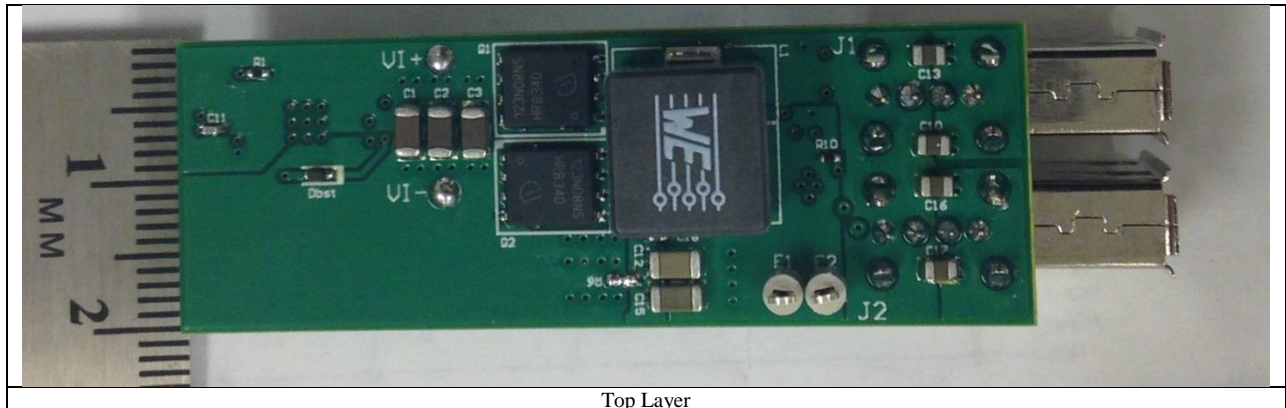

USB Direct Charging Port

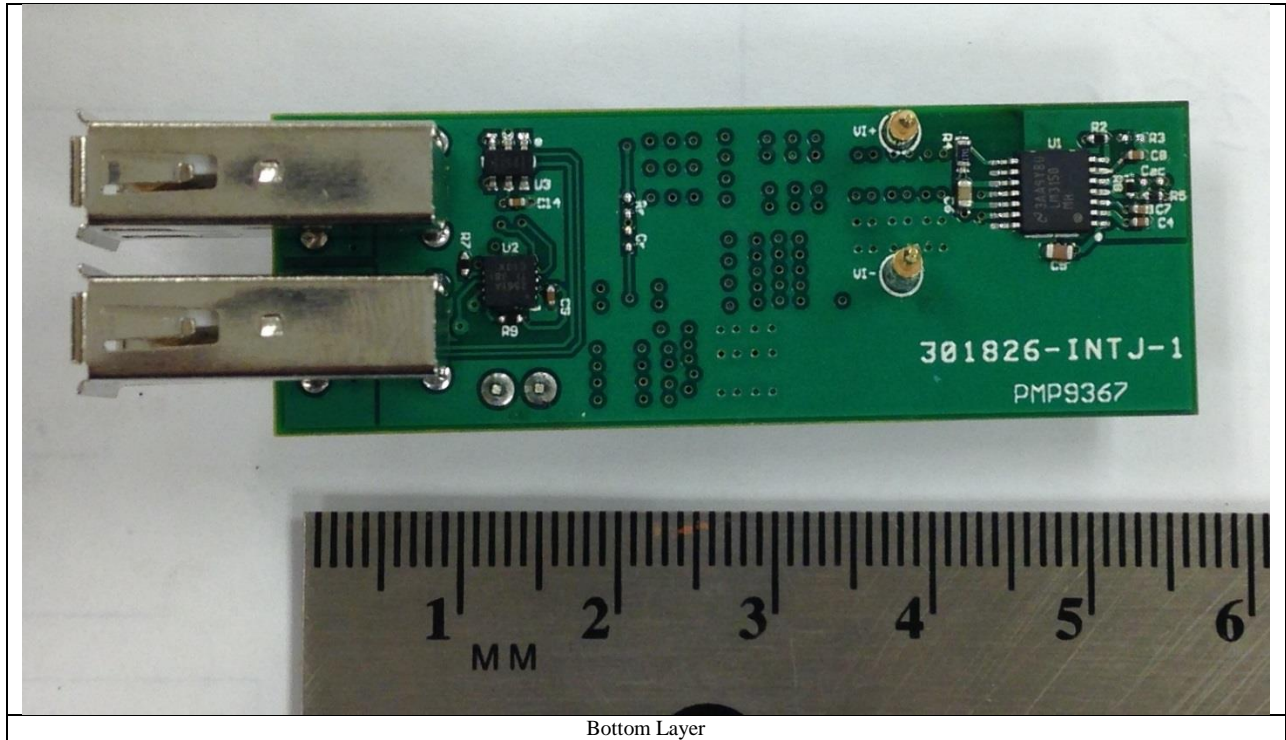

USB Direct Charging Port

2.1 Block Diagram

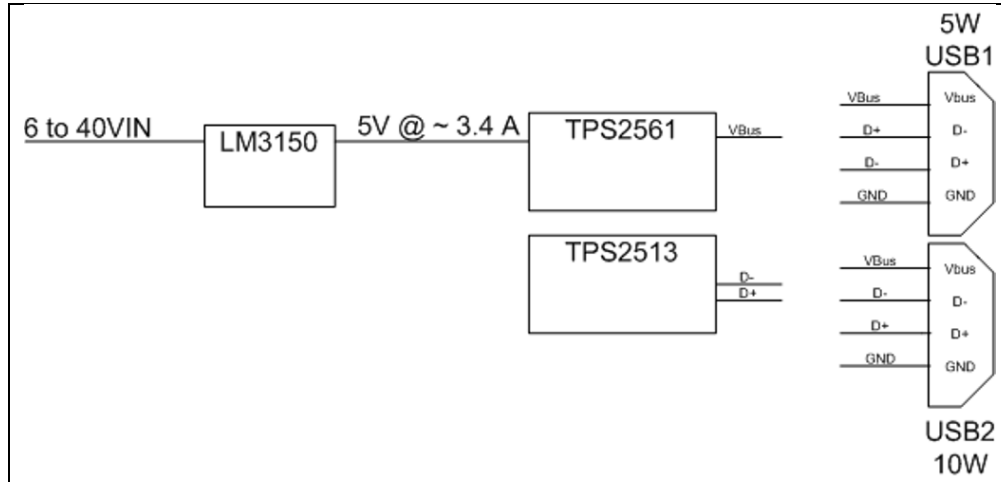

3. Efficiency

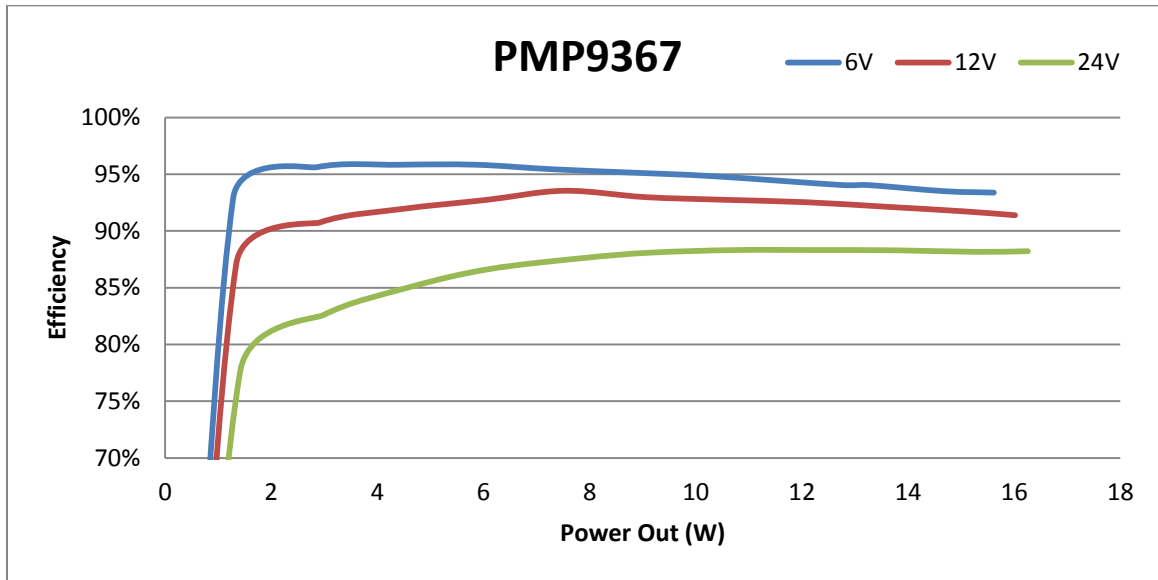

4. Load Regulation

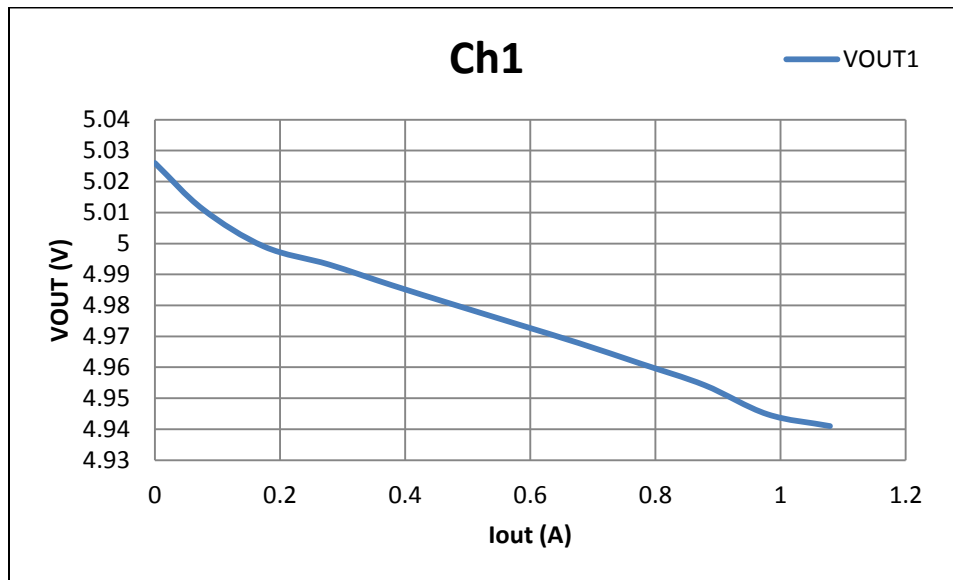

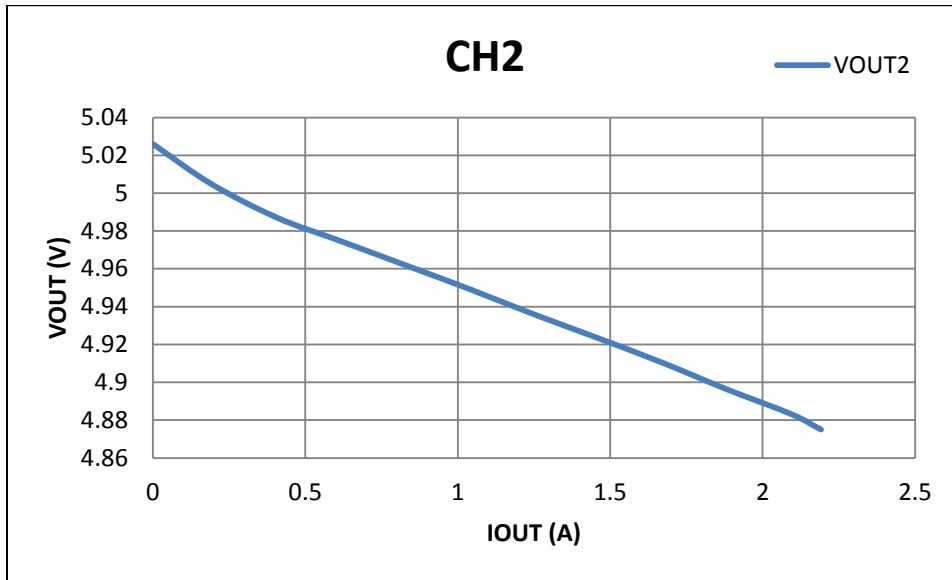

5. Thermal

5.1 Steady State Temperature, 12Vin and 15.5W out.

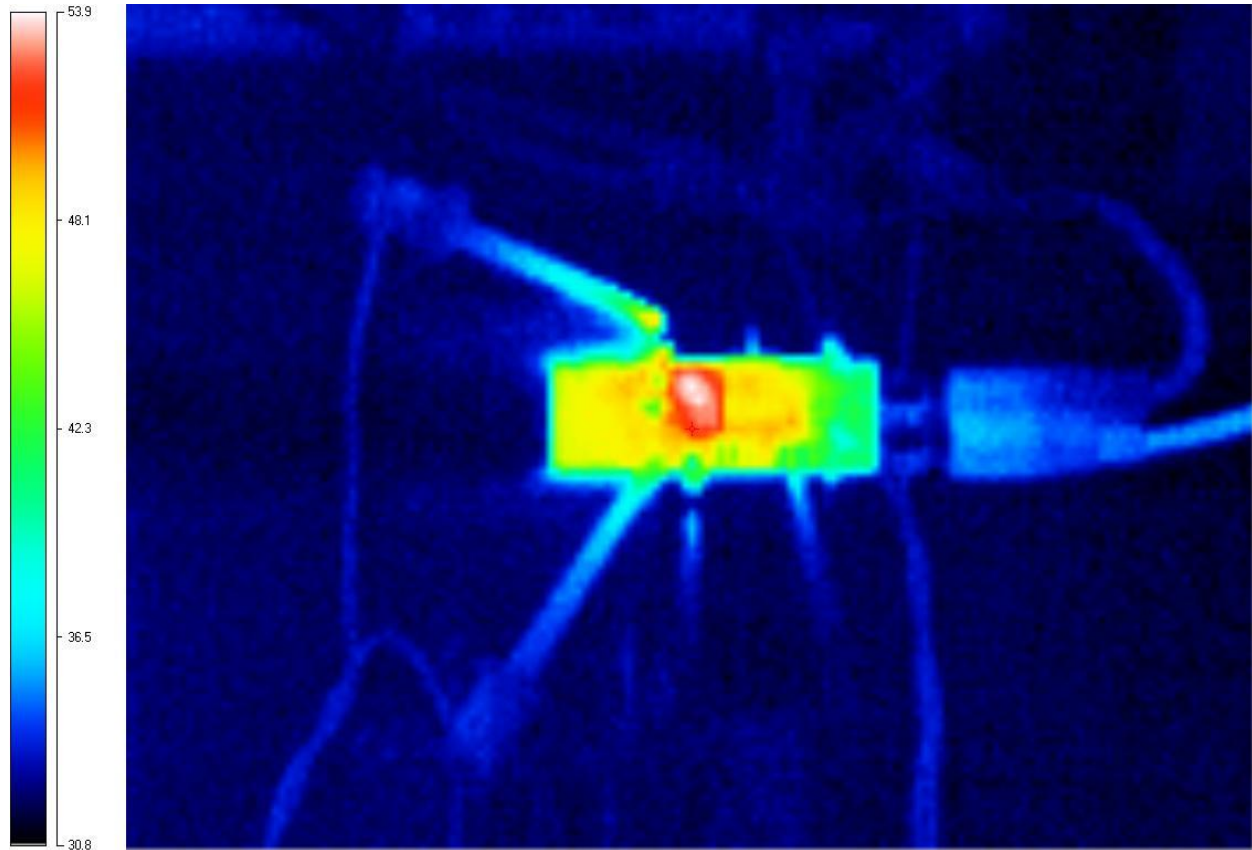

Top View

The warmest component on the module is the inductor. This image displays a 28°C temperature rise.

6. Power Up USB CH1

6.1 Power Up at 6V Input – No Load

Power Up at 6V Input – 1A Load

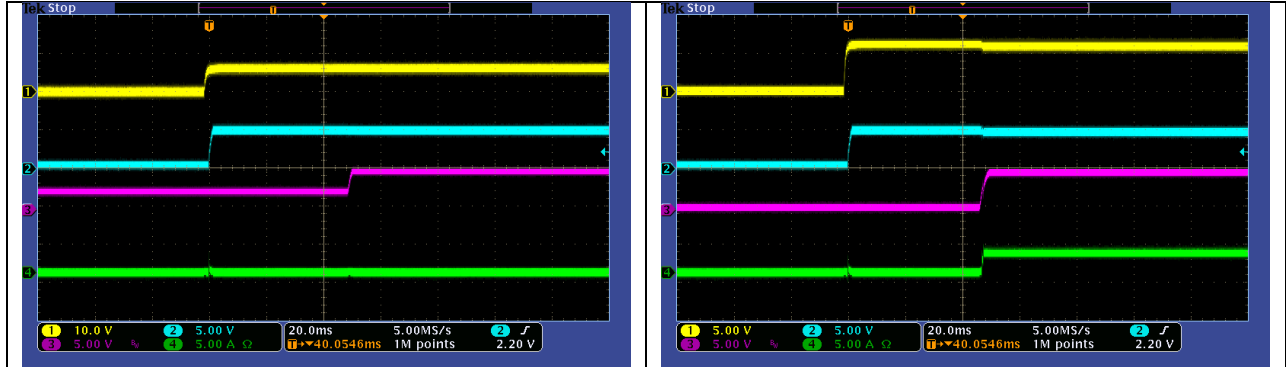

Channel 1 VIN
Channel 2 5Vout LM3150
Channel 3 J1 5Vout
Channel 4 IIN

6.2 Power Up at 12V Input – No Load

Power Up at 12V Input – 1A Load

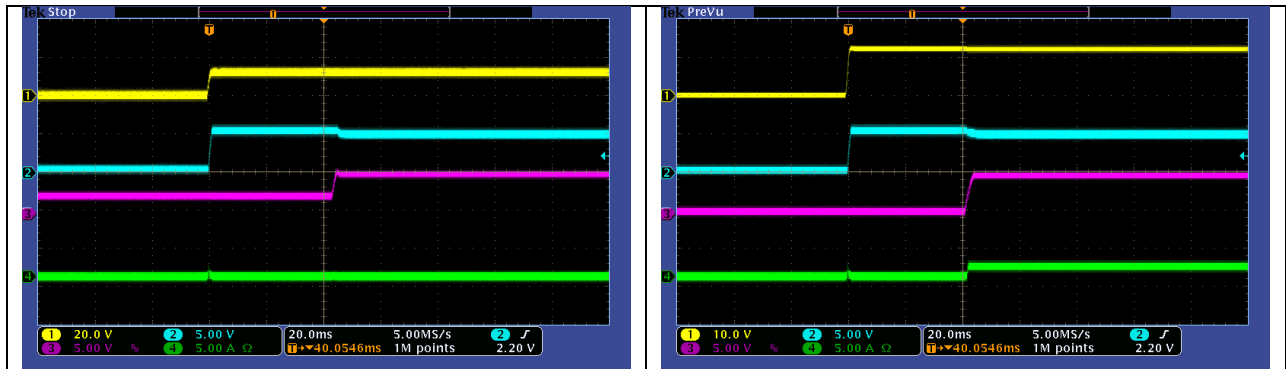

Channel 1 VIN
Channel 2 5Vout LM3150
Channel 3 J1 5Vout
Channel 4 IIN

6.3 Power Up at 36V Input – No Load

Power Up at 36V Input – 1A Load

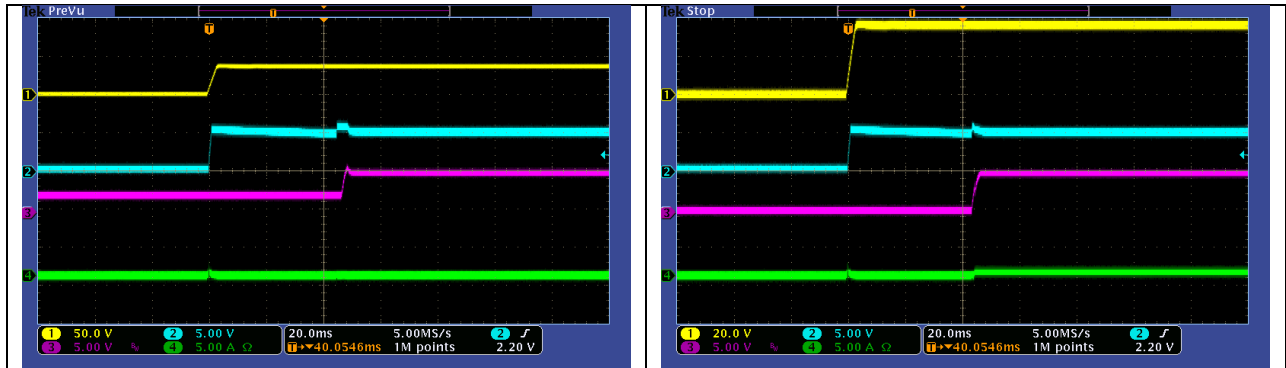

Channel 1 VIN
Channel 2 5Vout LM3150
Channel 3 J1 5Vout
Channel 4 IIN

Power Up USB CH2

6.4 Power Up at 6V Input – No Load

Power Up at 6V Input –2.1A Load

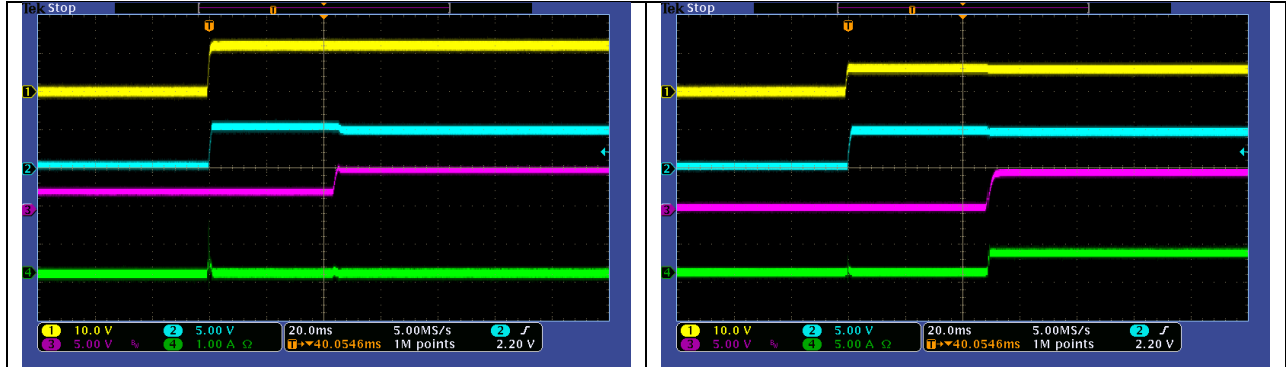

Channel 1 VIN
Channel 2 5Vout LM3150
Channel 3 J2 5Vout
Channel 4 IIN

6.5 Power Up at 12V Input – No Load

Power Up at 12V Input –2.1A Load

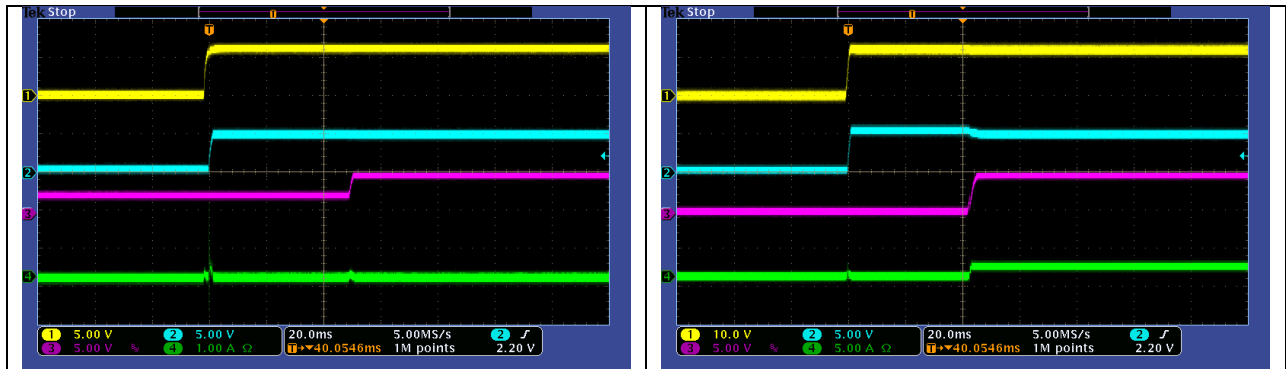

Channel 1 VIN
Channel 2 5Vout LM3150
Channel 3 J2 5Vout
Channel 4 IIN

6.6 Power Up at 36V Input – No Load

Power Up at 12V Input – 2.1A Load

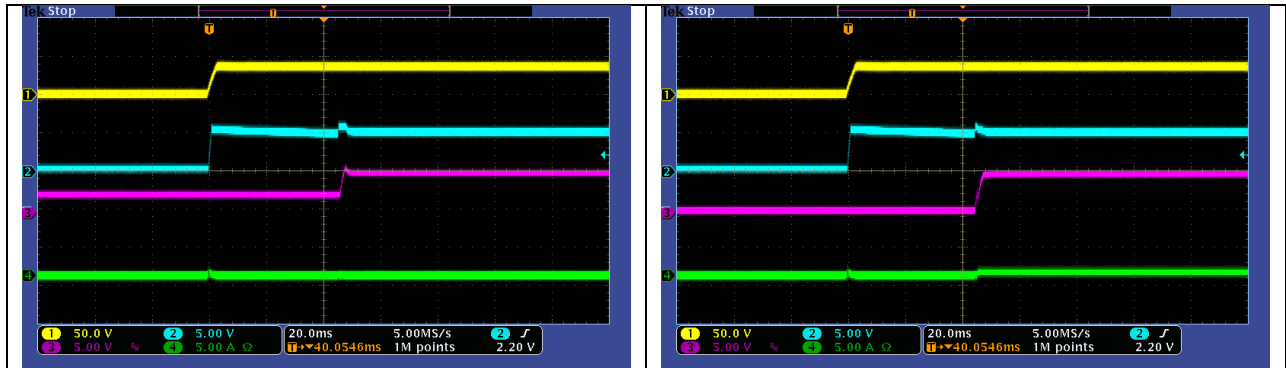

Channel 1 VIN
Channel 2 5Vout LM3150
Channel 3 J2 5Vout
Channel 4 IIN

7. Switching and Ripple

7.1 LM3150 5VOUT @ 3.1A

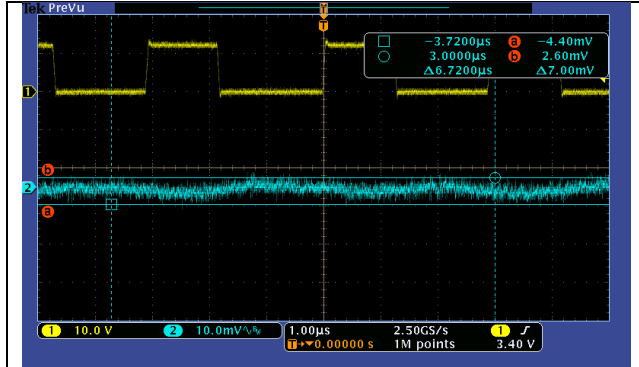

The cursors indicate 7mV ripple.

Channel 1 VSW
Channel 2 5Vout

8. Transient Response

A load step was applied to each channel and the transient response of the controller was monitored.

8.1 12V Input – 0.5A to 1A Step, 100mA/μs, 100 Hz. USB Ch1

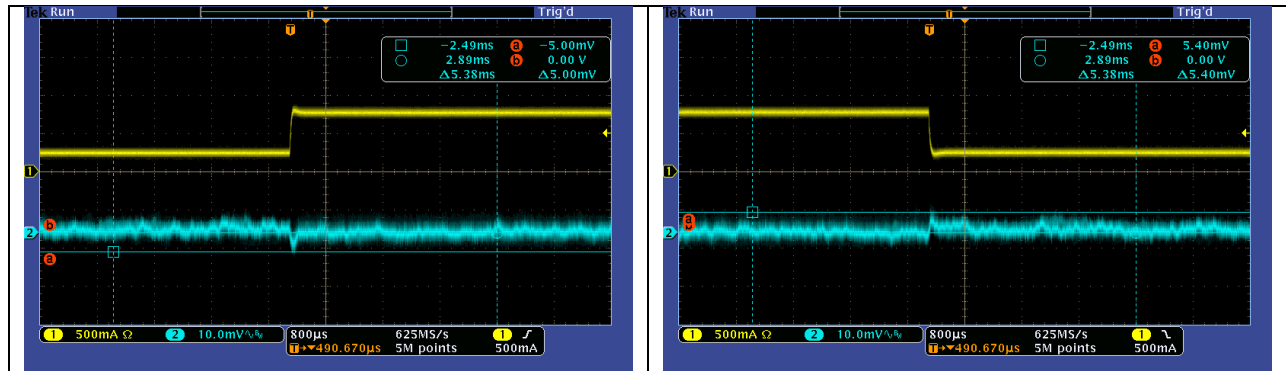

Cursors indicate ~5mV deviation across output capacitor.

8.2 12V Input – 1.05A to 2.1A Step, 100mA/μs, 100 Hz. USB Ch2

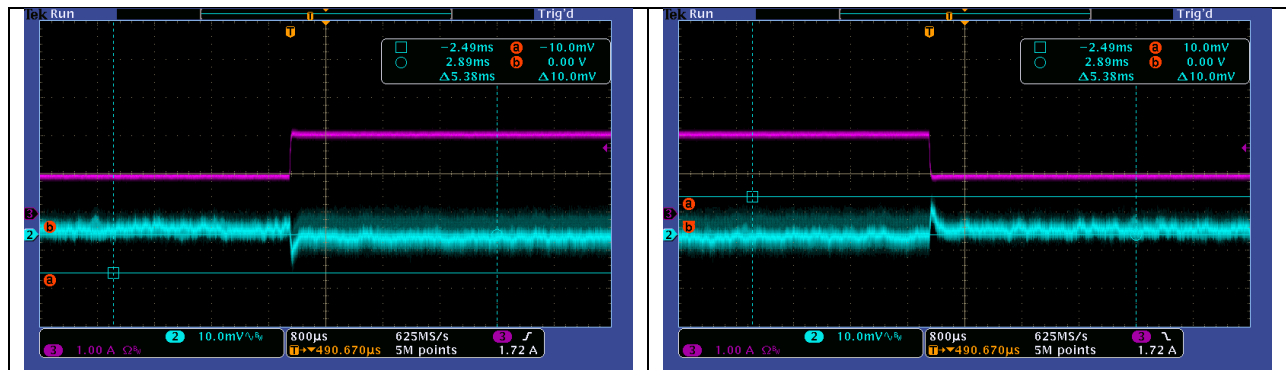

Cursors indicate ~10mV deviation across output capacitor.

9. Current Limit Tests 12V Input

9.1 LM3150

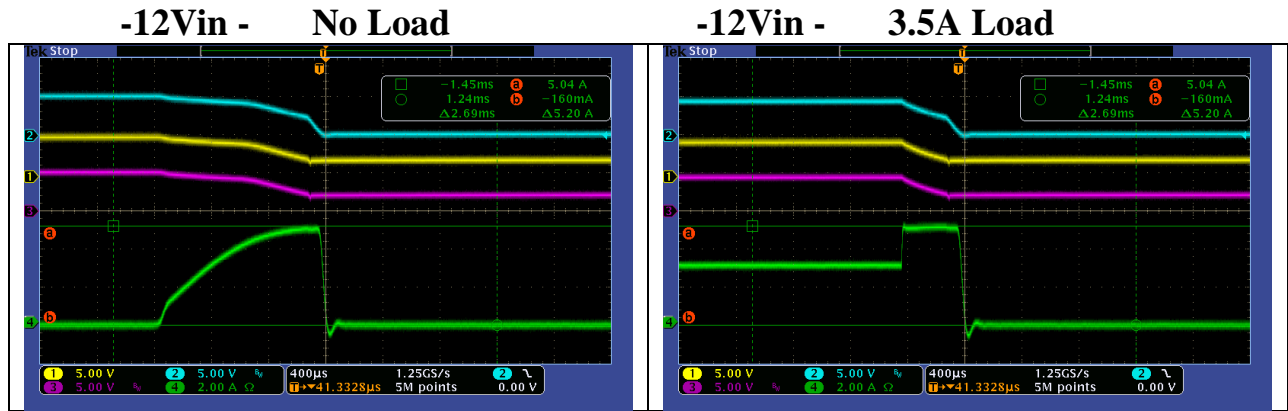

Channel 1 USB CH2
Channel 2 LM3150
Channel 3 USB CH1
Channel 4 IOUT

9.2 USB CH1

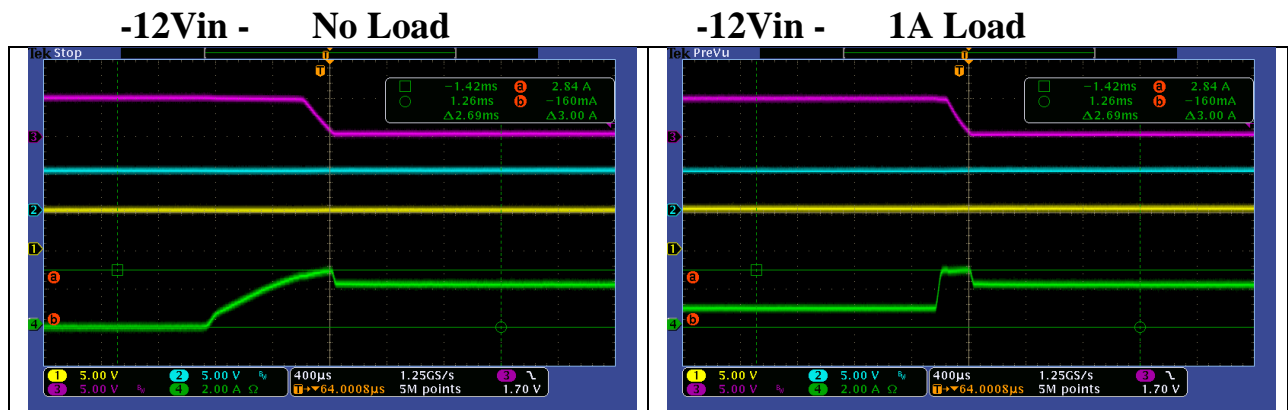

Channel 1 USB CH 1
Channel 2 LM3150
Channel 3 USB CH 2
Channel 4 IOUT

9.3 USB CH2

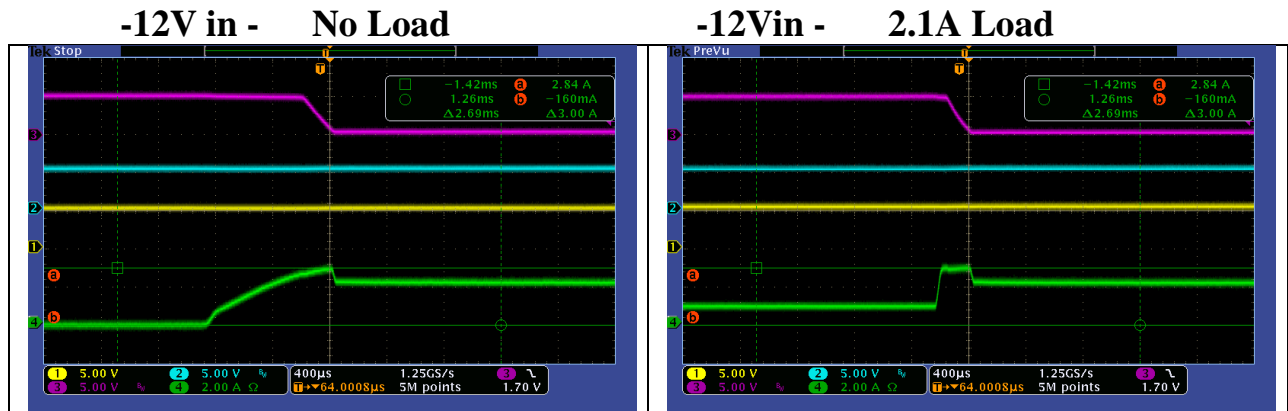

Channel 1 USB CH 1
Channel 2 LM3150
Channel 3 USB CH 2
Channel 4 IOUT

10.1 Short Circuit Tests

10.1 12Vin, LM3150 No Load

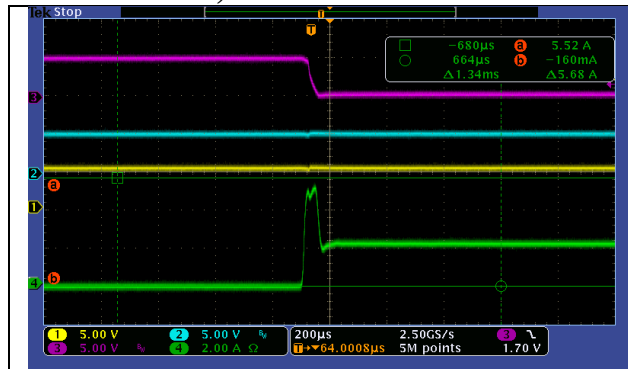

12Vin, LM3150 3.1A Load

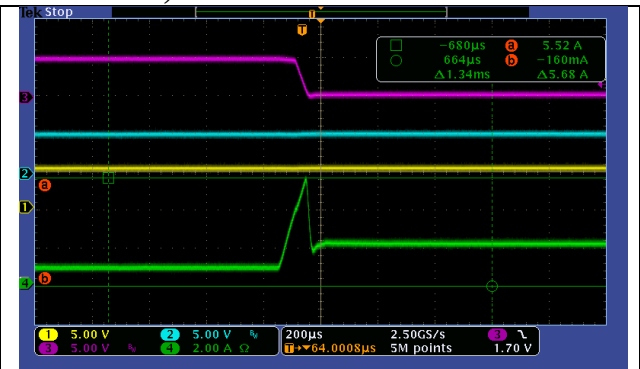

Channel 1 USB CH 1
Channel 2 LM3150
Channel 3 USB CH 2
Channel 4 IOUT

10.2 12Vin, USB CH1 No Load

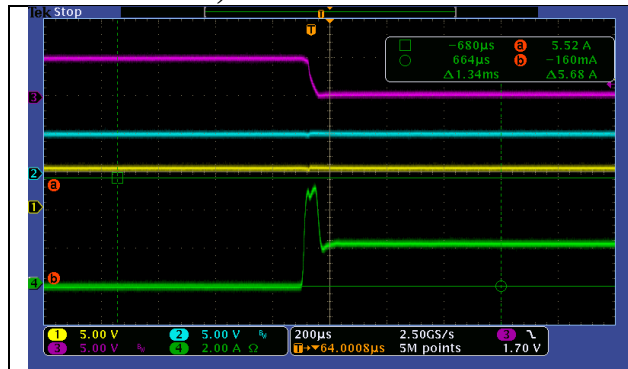

12Vin, USB CH1 1A Load

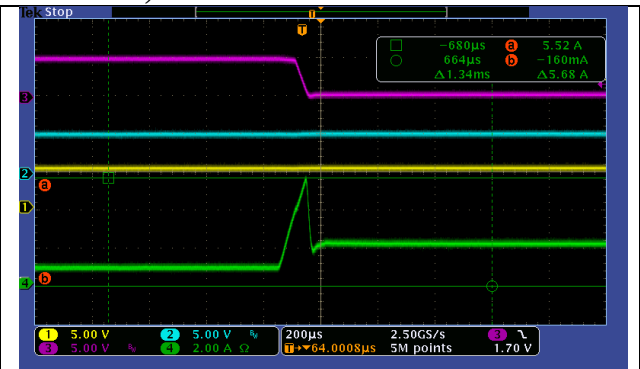

Channel 1 USB CH 1
Channel 2 LM3150
Channel 3 USB CH 2
Channel 4 IOUT

10.3 12Vin, USB CH2 No Load

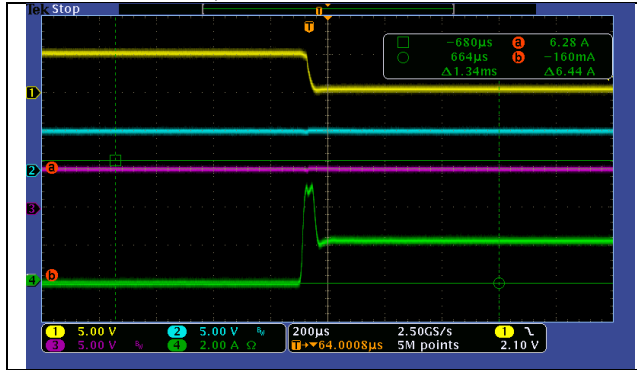

12Vin, USB CH2 2.1A Load

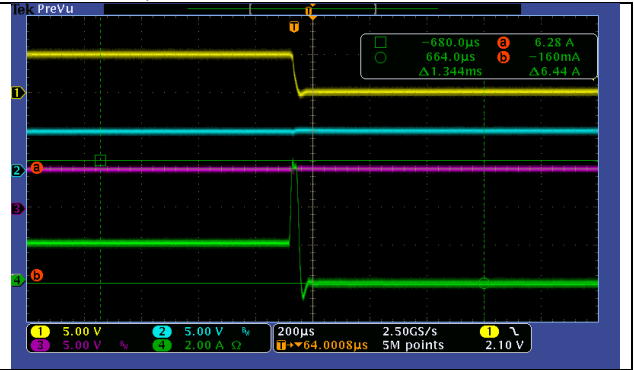

Channel 1 USB CH 1
Channel 2 LM3150
Channel 3 USB CH 2
Channel 4 IOUT

11. Short Circuit Recovery Tests

11.1 12Vin, LM3150 No Load

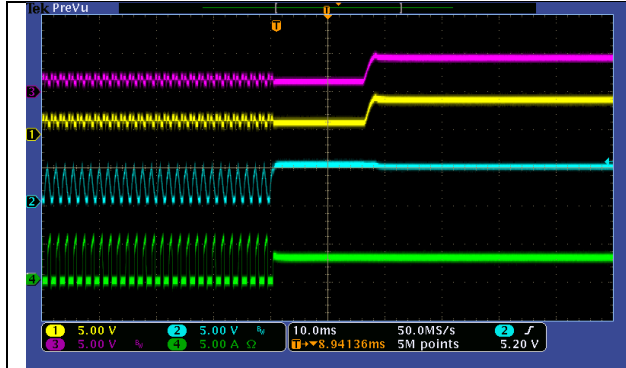

12Vin, LM3150 3.1A Load

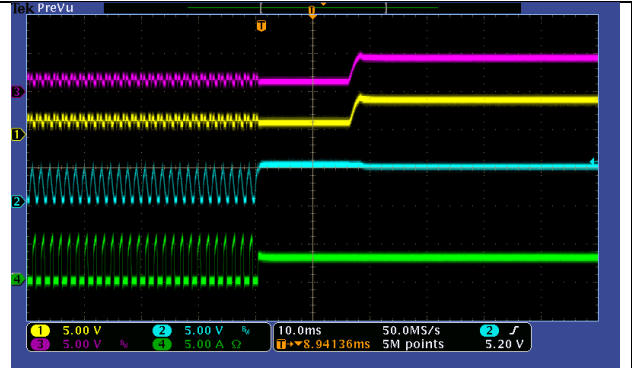

Channel 3 VOUT
Channel 4 IOUT

11.2 12Vin, USB CH1 No Load

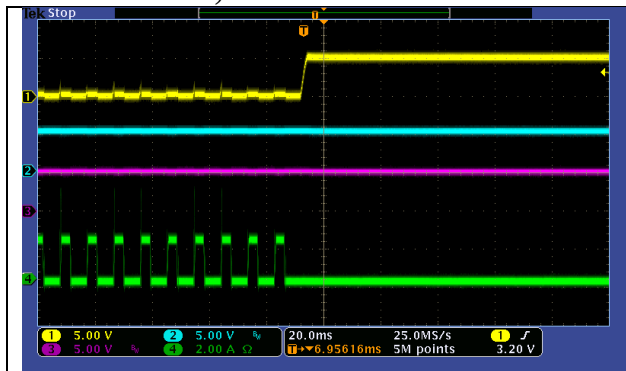

12Vin, USB CH1 1A Load

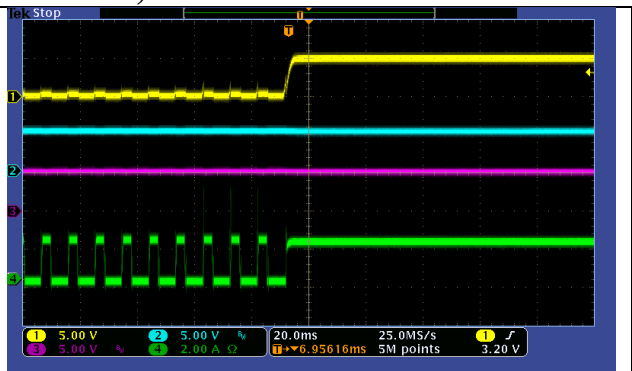

Channel 3 VOUT
Channel 4 IOUT

11.3 12Vin, USB CH2 No Load

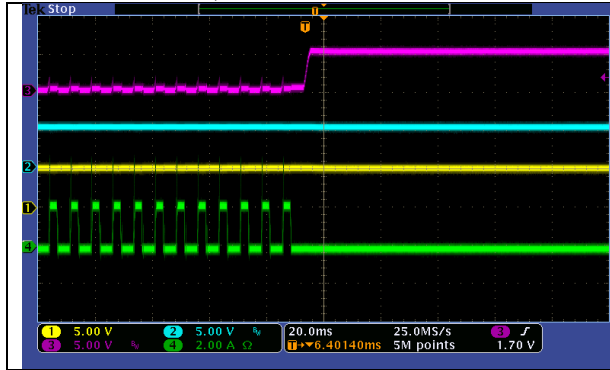

12Vin, USB CH2 2.1A Load

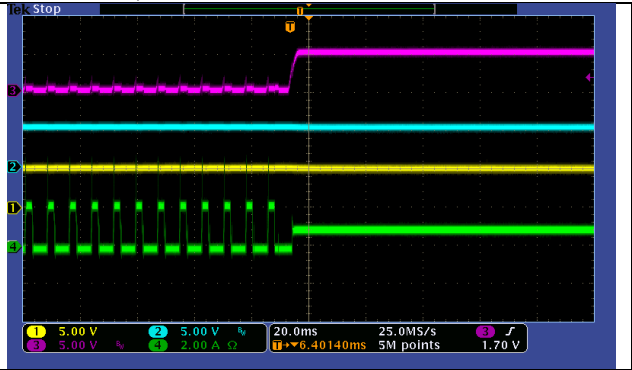

Channel 3 VOUT
Channel 4 IOU

IMPORTANT NOTICE AND DISCLAIMER

TI PROVIDES TECHNICAL AND RELIABILITY DATA (INCLUDING DATASHEETS), DESIGN RESOURCES (INCLUDING REFERENCE DESIGNS), APPLICATION OR OTHER DESIGN ADVICE, WEB TOOLS, SAFETY INFORMATION, AND OTHER RESOURCES "AS IS" AND WITH ALL FAULTS, AND DISCLAIMS ALL WARRANTIES, EXPRESS AND IMPLIED, INCLUDING WITHOUT LIMITATION ANY IMPLIED WARRANTIES OF MERCHANTABILITY, FITNESS FOR A PARTICULAR PURPOSE OR NON-INFRINGEMENT OF THIRD PARTY INTELLECTUAL PROPERTY RIGHTS.

These resources are intended for skilled developers designing with TI products. You are solely responsible for (1) selecting the appropriate TI products for your application, (2) designing, validating and testing your application, and (3) ensuring your application meets applicable standards, and any other safety, security, or other requirements. These resources are subject to change without notice. TI grants you permission to use these resources only for development of an application that uses the TI products described in the resource. Other reproduction and display of these resources is prohibited. No license is granted to any other TI intellectual property right or to any third party intellectual property right. TI disclaims responsibility for, and you will fully indemnify TI and its representatives against, any claims, damages, costs, losses, and liabilities arising out of your use of these resources.

TI's products are provided subject to TI's Terms of Sale (<https://www.ti.com/legal/termsofsale.html>) or other applicable terms available either on [ti.com](https://www.ti.com) or provided in conjunction with such TI products. TI's provision of these resources does not expand or otherwise alter TI's applicable warranties or warranty disclaimers for TI products.

Mailing Address: Texas Instruments, Post Office Box 655303, Dallas, Texas 75265
Copyright © 2021, Texas Instruments Incorporated