

# TI Designs

## High-Speed Sensorless-FOC Reference Design for Drone ESCs



### Overview

ESC modules are important subsystems for non-military drones and users demanding more efficient models that provide longer flight times and higher dynamic behavior with smoother and more stable performance. This TI Design implements an electronic speed controller (ESC) commonly used for unmanned aerial vehicles (UAV) or drones. The speed control is done sensorless, and the motor has been tested up to a 1.2-kHz electrical frequency (12 kRPM with a 6-pole pair motor), using FOC speed control. Our high-speed sensorless-FOC reference design for drone ESCs provides best-in-class FOC algorithm implementation to achieve longer flight time, better dynamic performance and higher integration, resulting smaller board size and fewer BOM components. Sensorless high-speed FOC control using TI's FAST™ software observer leveraging InstaSPIN-Motion™ C2000™ LaunchPad™ and DRV8305 BoosterPack™.

### Resources

<a href="#">TIDA-00916</a>	Design Folder
<a href="#">DRV8305</a>	Product Folder
<a href="#">TMS320F28069F</a>	Product Folder
<a href="#">DRV8305N 3-Phase Motor Drive BoosterPack</a>	Tool Folder
<a href="#">C2000 Piccolo F28069M MCU LaunchPad</a>	Tool Folder
<a href="#">TIDA-00643</a>	Design Folder

### Features

- InstaSPIN-FOC™ Sensorless FOC Achieves Highest Dynamic Performance, Tested up to 12,000 RPM With Three LiPo Cells
- High Dynamic Performance: 1 to 10 kRPM (Electrical Frequency 100 Hz to 1 kHz) Speed in <0.2 s to Provide High Performance Yaw and Pitch Movement
- Fast Speed Reversal Capability for Roll Movement
- Longer Flight Time Due to Improved Efficiency of FOC Over Block Commutation
- Higher PWM Switching Frequency, Tested up to 60 kHz to Reduce Current and Torque Ripple With Low-Inductance, High-Speed Motors and to Avoid Interference With Ultrasonic Sensors
- Flexible Power Stage Supports Two to Six LiPo Cells
- Fast Time-to-Market Due to InstaSPIN-FOC's Automatic Motor Parameter Identification: Auto-Tuning Sensorless FOC Solution
- Motor Temperature Estimation From Winding Resistance Changes to Protect Motor From Damage During Temporary Overload Conditions

### Applications

- Drones and UAVs
- High-Speed Motors
- Battery-Operated Power Tools

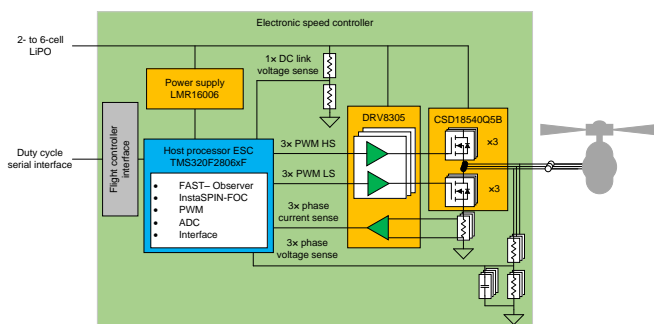
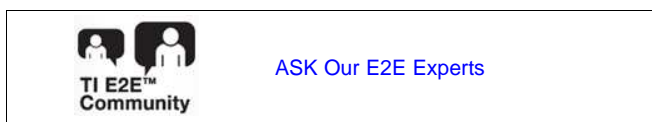

Copyright © 2016, Texas Instruments Incorporated

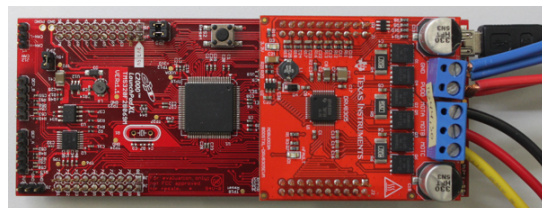



An IMPORTANT NOTICE at the end of this TI reference design addresses authorized use, intellectual property matters and other important disclaimers and information.

## 1 System Overview

### 1.1 System Description

When looking at a drone, the following module definitions are typically used to the different subsystems needed to build the full drone flight system. This is shown in Figure 1.

**Flight Controller**

Brain of the flying system; accepts the commands from remote; interfaces with sensors systems and controls ESCs, camera commands, gimbal, stability, and so on; assist in image transmission

**Electronic Speed Controller (ESC)**

Typically four or more, brushed DC or brushless DC motor, speed control for thrust and direction change

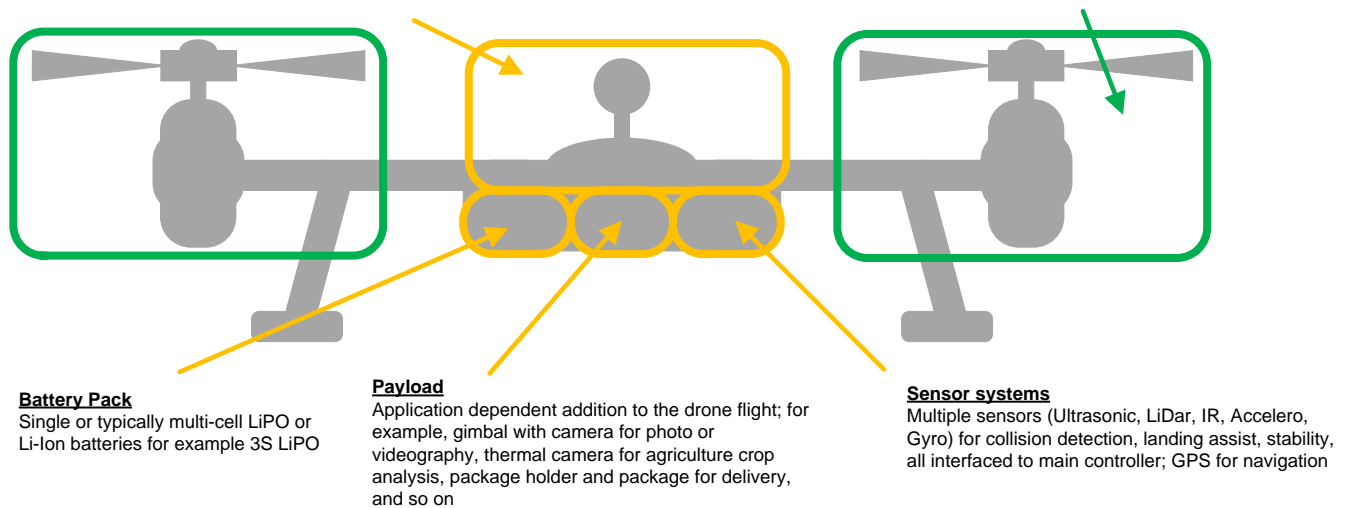

**Figure 1. Modules for Drone Flight System**

This TI design guide focuses on the electronic speed controller (ESC).

#### 1.1.1 ESC Feature Requirements for Drones

The ESC defines the dynamic movement performance and the flight time of the drone. Some of the movement patterns that the drone has to be able to do are:

- Precise movement patterns: traveling, hovering
- Quick movement patterns: 360° turns in x,y,z directions, max speed horizontal, max speed vertical

To provide these features, a good ESC is needed to control the generated lift at all speeds of the used motor. This way the stabilization algorithms based on the position sensor module can compensate the vibration and external forces affecting the drone. The faster the motor's speed can be changed, the fewer speed changes the stabilization algorithm has to perform; this leads to using less energy than running the drone at a highly varying speed, which would be the case with an ESC of less dynamics.

#### 1.1.2 Best System Performance

Defining the details from the previous sections is important to know what system performance of the drone is desired. With this system specification, the performance of the ESC can be defined. Depending on which kind of drone is being built, compromises can be made to the performance of the ESC.

When building a low-end drone, typically a brushed DC motor or a three-phase trapezoidal back-EMF controlled motor is used because they are cheap and provide acceptable performance. These motors are usually run with open loop control. This is true for both angle and current control.

For a mid-range drone, typically a three-phase trapezoidal back-EMF motor is used. The difference from before is now that this motor would run with a closed loop angle estimation, and maybe a simple current control algorithm, but typically it would be open loop current control. A low-performance controller is used, thus saving cost.

For high-end drones, usually three-phase sinusoidal back-EMF motors are used. In some cases, also a trapezoidal back-EMF motors are used, leading to worse dynamic performance than what sinusoidally wound motors would achieve.

There is currently a trend of transitioning from trapezoidal to sinusoidal control, and with this move sensorless control becomes more important as an angle sensor would make the solution not cost competitive. Besides cost, a second issue here is the high speed required from the sensor.

This of course generates some effort for people wanting to build an ESC to develop a sensorless algorithm that will give good enough angle accuracy to control the motor.

### 1.1.2.1 Sinusoidal Controlled ESC Module

In this TI Design, the focus is on an ESC using a sinusoidal control. With this choice, consider the following:

- Measure the magnetic field angle of the rotor within a 1- to 5-degree minimum accuracy to ensure maximum torque using FOC algorithm, or
- Estimate the rotor magnetic angle based on the motor's phase voltages and phase currents (sensorless algorithm)

Figure 2 shows typical PWM high-side and low-side patterns for three phases and the corresponding ideal filtered phase voltages after removing the PWM carrier when running the motor with sinusoidal control.

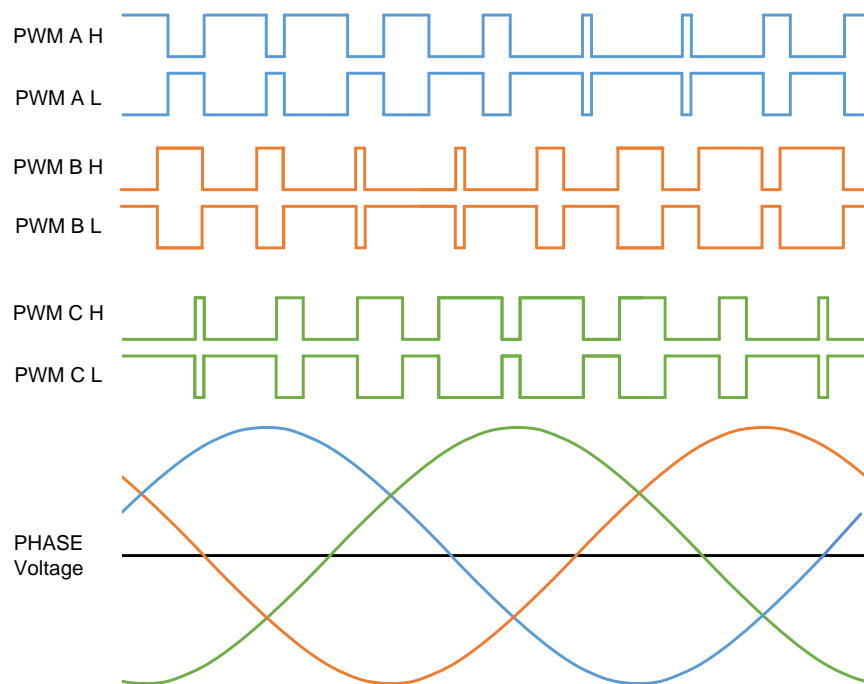

**Figure 2. Generation of Ideal PWM-to-Sinusoidal Phase Voltages**

Due to the small change of angle, the torque ripple of the system is kept to a minimum compared to a trapezoidal control scheme. Once the control algorithm has been chosen, the next step is to decide if the control should be open or closed loop.

In an open-loop control, the synchronous motor (BLDC or BLAC) is blindly driven with a control signal and it is assumed that it follows the designated control action.

One issue is the assumption that the motor follows the control signal may be erroneous. To ensure that the motor performs correctly, more current than what is ideally needed is put on the windings to force the movement. Ultimately, this is the main reason why system efficiency in an open-loop control is reduced when compared to a closed-loop controlled motor.

In closed-loop control, the motor control has the ability to test if the motor moves as expected. If not, the control loop automatically compensates by either reducing or increasing the current.

Whether using a closed-loop control or a sensorless algorithm, the current- and voltage signals have to be measured, so they can be used as feedback signals. For sinusoidal control, measure up to three shunt currents. For the voltage measurements, choose between measuring only the DC link voltage or the three-phase voltages and the DC link voltage. Figure 3 shows measurement configurations for sinusoidal control.

For more detail on control algorithms, see the motor control compendium[9].

### 1.1.3 Electronic Speed Controller (ESC)

The motors of the drone have to run on a speed that depends on the weight of the drone and the size of the propellers to generate the needed lift for the drone to fly. Looking at typical three-phase brushless motors built for drones, the following properties are common:

- Low inductance
- Low resistance
- Two to eight pole pairs
- 1000-Hz or higher electrical frequency

The motor is built to be optimized to use with LiPo batteries with two to six cells, meaning a DC voltage from 7.4 to 22.2 V. These voltages are used to design the maximum speed for the chosen motor.

A typical issue here is running the motor close to  $V_{BUS}$  at maximum speed, as here both the FOC algorithm and the sensorless algorithm have to be good enough to support this operation.

The ESC used in this report is built to work for a three-phase brushless motor using a sensorless algorithm. Components of the ESC module is shown in Figure 3.

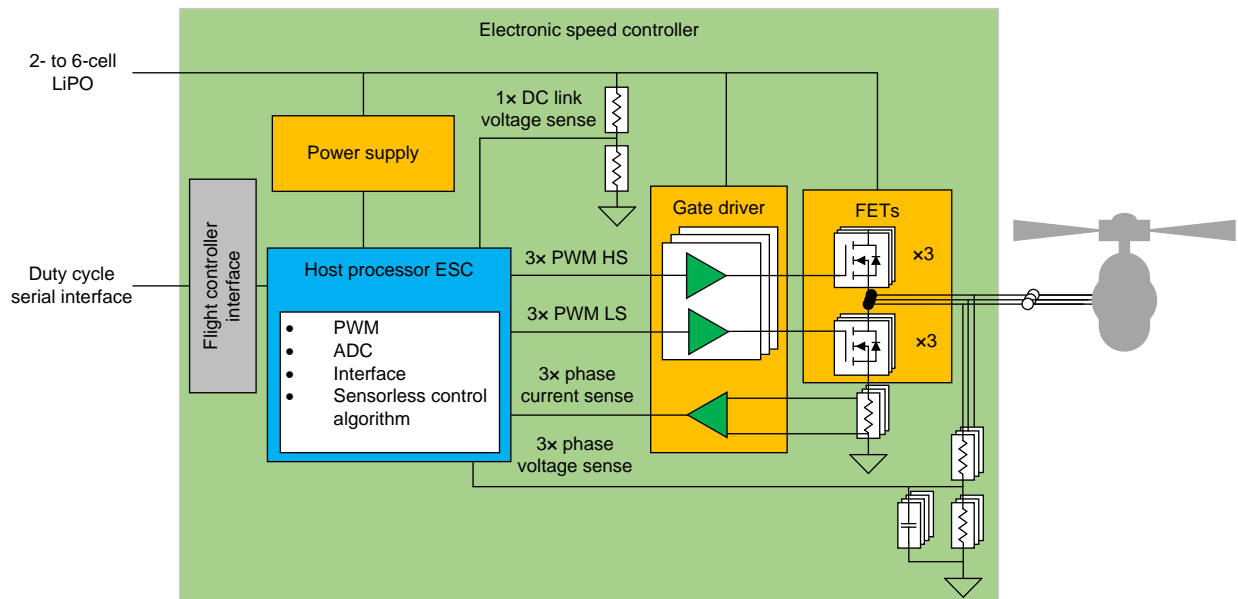

Copyright © 2016, Texas Instruments Incorporated

Figure 3. Block Diagram for Drone ESC

## 1.2 Key System Specifications

For this TI Design, a three-phase half-bridge power stage is required with the aforementioned sensing capabilities to generate the feedback signals for the sensorless algorithm.

This power stage has to run from a LiPo battery with between two to six cells, meaning a  $V_{BUS}$  from 7.4 to 22.2 V.

Due to the low time constant of the motor and frequency dependent sensors, the PWM frequency is high; typical current designs use PWM frequencies of around 45 to 60 kHz with a tendency to increase it even further.

Secondly, a way to communicate with the flight controller is required, which can be done using duty cycle or serial communication.

**Table 1. Key System Specifications**

PARAMETER	SPECIFICATIONS
Input voltage	4.4 to 45 V supporting LiPo battery two to six cells or more
PWM frequency for motor phases	45 kHz or higher
Angle detection	Sensorless angle estimation using InstaSPIN-FAST for full speed range
Sensorless angle accuracy	For high efficiency: Angle accuracy within $\pm 1$ count of a 1024 mechanical encoder steady state
Motor control algorithm	Speed control with FOC algorithm for high speed motor
Current control	22.5 kHz
Current loop bandwidth	2.5 kHz (Hardware dependent)
Observer	22.5 kHz
Speed range	-12 to 12 kRPM
Acceleration	Up to 86 kRPM/s
Firmware	InstaSPIN-FOC

### 1.2.1 Power Stage

The LaunchPad and BoosterPack are built to work from a single supply. This supply can be in the range of 4.4 to 45 V. The power stage consists of three half-bridges used for the brushless DC drive. These three half-bridges have to provide the power for the motor at maximum speed, which can be up to 500 W in the motor.

### 1.2.2 Voltage and Current Sensing

The BoosterPack also enables the voltage and current sensing necessary for the sensorless algorithms. In this case,  $V_{BUS}$ , three phase voltages, and three phase currents are measured. The current measurements are done using low-side shunts, the three current-sense amplifiers used are integrated into the DRV8305 IC.

### 1.2.3 ESC Controller

For the ESC controller, the TMS320F28069F is used to provide the motor control platform. Using this device, the sensorless back-EMF observer algorithm InstaSPIN-FAST is enabled.

This algorithm provides the customer a back-EMF based angle estimator and now only the FOC algorithm has to be considered for the design phase of the motor control.

The InstaSPIN-FOC algorithm is provided as a BSD-licensed open-source software package called MotorWare™; with this package, the customer can start using FOC motor control, and this algorithm can be updated and improved with customer-specific algorithms focusing on the actual movement of the motor and not the angle estimation, which is replacing the angular sensor.

### 1.3 Block Diagram

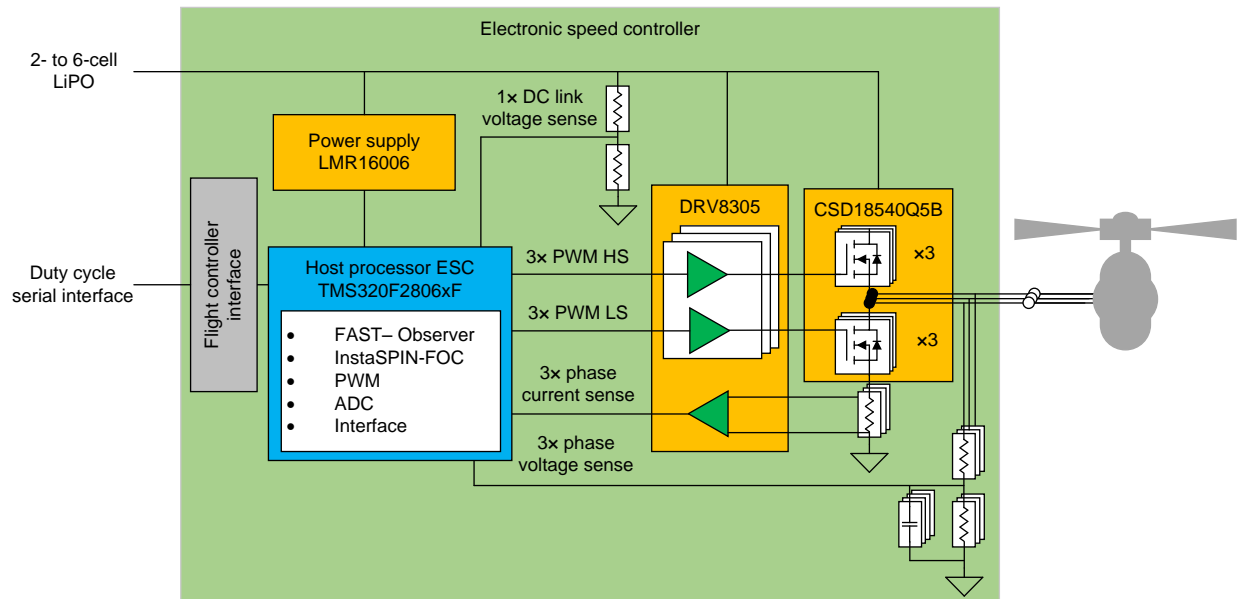

Copyright © 2016, Texas Instruments Incorporated

**Figure 4. Block Diagram**

### 1.4 Highlighted Products

The following key products are used in this TI Design with the key features highlighted.

#### 1.4.1 TMS320F2806xF

The F2806xF Piccolo™ family of microcontrollers (MCUs) provides the power of the C28x core and control law accelerator (CLA) coupled with highly integrated control peripherals in low pin-count devices.

An internal voltage regulator allows for single-rail operation. Enhancements have been made to the high-resolution pulse width modulator (HRPWM) module to allow for dual-edge control (frequency modulation). Analog comparators with internal 10-bit references have been added, and can be routed directly to control the ePWM outputs. The ADC converts from a 0- to 3.3-V fixed full-scale range and supports ratiometric  $V_{REFHI}/V_{REFLO}$  references. The ADC interface has been optimized for low overhead and latency.

This device has special motor control software in execute-only ROM to enable InstaSPIN-FOC solution, with system software support through MotorWare.

InstaSPIN-FOC features + FAST:

- Replace mechanical encoders and resolvers in a "sensorless" field oriented torque controller (FOC)
  - Uses the FAST™ software encoder as a superior rotor flux sensor
- Control system design accelerated
  - Built-in motor parameter identification
  - Automatic closed loop current control tuning
  - Fully tuned observer and stable torque controller in minutes
- Full InstaSPIN™-FOC control system available in ROM
  - Select Piccolo MCU devices
  - Software API and multiple example projects through MotorWare software
- Voltage and current filtering insure quality sampled signals to the system
  - One time hardware and software calibration
  - Offset compensation

- Solving the start-up challenge:
- FAST software encoder stability at zero speed enables:
  - Zero speed start-up feature provides 100%+ torque at start and closed loop control with FAST providing angle in less than one electrical cycle
  - Full closed loop from zero speed ready—just supply electrical starting angle from additional initial position detection algorithms
- Motor identification
  - No datasheet required
  - One time parameter identification based on simple motor nameplate data (max voltage, current)
  - Optional Rs online feature can track resistance changes and provide compensation during operation
  - FAST Software Encoder

#### 1.4.2 DRV8305

The DRV8305 is a gate driver IC for three-phase motor drive applications. It provides three high-accuracy trimmed and temperature compensated half-bridge drivers, each capable of driving a high-side and low-side enhancement-mode N-channel MOSFET. The DRV8305 includes three shunt-based current-sense amplifiers for accurate current measurements, supports 100% duty cycle, and has multiple levels of protection. The gate driver is programmable through a serial peripheral interface (SPI).

The main features of this device are:

- 4.4- to 45-V operating voltage
- 1.25-A and 1-A peak gate drive currents
- Charge-pump gate driver for 100% duty cycle
- Three integrated current-shunt amplifiers
- 3- or 6-PWM input control up to 200 kHz
- SPI for device settings and fault reporting
- Protection features:
  - Fault diagnostics and MCU watchdog
  - Programmable dead-time control
  - MOSFET shoot-through prevention
  - MOSFET  $V_{DS}$  overcurrent monitors
  - Gate driver fault detection
  - Reverse battery protection support
  - Limp home mode support
  - Over-temperature warning and shutdown

### 1.4.3 LMR16006

The PWM DC/DC buck (step-down) regulator has a wide input range of 4 to 60 V. It is suitable for a wide range of applications from industrial to automotive for power conditioning from an unregulated source. The regulator's standby current is 28  $\mu\text{A}$  in ECO mode, which is suitable for battery-operated systems.

The main features of this device are:

- Ultra-low 28- $\mu\text{A}$  standby current in ECO mode
- Input voltage range: 4 to 60 V
- 1- $\mu\text{A}$  shutdown current
- Output current up to 600 mA
- 0.7- and 2.1-MHz switching frequency
- Internal soft-start
- Overcurrent protection
- Over-temperature protection

### 1.4.4 CSD18540Q5B

This 60-V, 1.8-m $\Omega$ , SON 5-mm $\times$ 6-mm NexFET™ power MOSFET is designed to minimize losses in power conversion applications.

The main features of this device are:

- Ultra-low  $Q_g$  and  $Q_{gd}$
- Low thermal resistance
- Avalanche rated
- Logic level
- Pb-free terminal plating
- RoHS compliant
- Halogen free



## 2 Getting Started Hardware and Software

### 2.1 Hardware

This section describes the different sub-modules of the complete design and explains the choices made during the component selection and schematic design process.

- Power Management
- 3-Phase Power Stage
- Voltage- and Current Sensing
- ESC Host Controller
- Flight Controller Interface

#### 2.1.1 Power Management

To power the F2806xF processor, the LMR16006 supplies 3.3 V with up to 0.6 A of current.

#### 2.1.2 Three-Phase Power Stage

The power stage uses the DRV8305 gate driver IC and 6x CSD18540Q5B NextFET ICs for the three half-bridges. The NextFET chosen has an  $R_{ds(on)}$  of 1.8 m $\Omega$ . The design is built to provide up to 15-A<sub>RMS</sub> or 20-A<sub>PEAK</sub> currents. For more details on the design, see the [BOOSTXL-DRV8305EVM User's Guide](#) (SLVUA18) describing the BoosterPack.

#### 2.1.3 Voltage and Current Sensing

To use the InstaSPIN-FAST observer, seven sensing signals are needed: four voltage measurements (three phase voltages and one DC link voltage), and three current measurements (three phase currents); see [Figure 4](#).

The changes done to the BoosterPack's sensing circuit are described in [Section 2.1.3.1](#). For details on the sensing circuit, see the [BOOSTXL-DRV8305EVM User's Guide](#) (SLVUA18).

##### 2.1.3.1 Voltage Sensing

The standard BoosterPack is built to work across the voltage range of 4.4 to 45 V. As this voltage range is a lot higher than the voltages used on drones, the voltage scale must be changed to increase accuracy of the voltage signals. The resistors R8, R9, R10, and R14 are changed to adjust the voltage scale. The voltage sensing of the DRV8305 BoosterPack can be seen in [Figure 5](#).

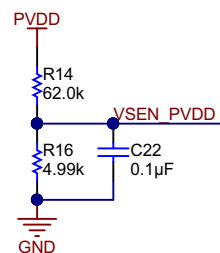

Copyright © 2016, Texas Instruments Incorporated

**Figure 5. Voltage Sense Circuit of BoosterPack**

Here, the electrical speed of the motor is also defined with the filter composed of series resistors R14 and R16 and the capacitor C22.

When defining this filter, consider the following:

- How many pole pairs does the motor have?
- What is the maximum RPM the motor is running at?

With this in mind, [Equation 1](#) is used to calculate the maximum voltage frequency of the motor.

$$f_{\text{voltage}} = \frac{\text{MAX}_{\text{rpm}}}{\text{sec}} \times \text{pp} = \frac{12000 \text{ rpm}}{60 \text{ sec}} \times 6 = 1200 \text{ Hz} \quad (1)$$

This shows that the filter frequency of the voltage measurement has to be around 1200 Hz to not attenuate the signal more than necessary. To calculate the filter pole, use [Equation 2](#):

$$f_{\text{filter\_pole}} = \frac{1}{2 \times \pi \times R_{\text{parallel}} \times C} = \frac{1}{2 \times \pi \times \left( \frac{R14 \times R16}{R14 + R16} \right) \times C22} \quad (2)$$

In this case, the resistor R14 and R16 was chosen to 62.0 kΩ and 4.99 kΩ, and C22 was chosen to 0.033 μF. This equals a  $f_{\text{filter\_pole}}$  of 1044.3 Hz.

This frequency is a little below the motor frequency, but should still be high enough to not attenuate the signal too much.

### 2.1.3.2 Current Sensing

The current sensing circuit of the board is built to support up to 20 A, which is reasonable considering the power requirements from the system. No change was done to the current sensing hardware to use the board for this TI Design.

### 2.1.4 ESC Host Controller

The ESC host controller has to be able to run an FOC algorithm, the sensorless angle estimation algorithm, and the communication. This has to be done while it is ensured that the FOC algorithm and the angle estimation are executed at a predefined time. The higher the PWM frequency, the less the available time will be to execute these two algorithms. Here, efficient use of host controller peripherals can be used to gain execution time. The controller used is part of the C2000 portfolio with the angle estimator (InstaSPIN-FAST).

For this TI Design, the TMS320F28069M is used. For an end system, either a TMS320F2806xF or a TMS320F2802xF can be used, depending on the additional software or hardware implementation required for the ESC host controller. Here, consider the flight controller interface to ensure the correct peripherals are available.

### 2.1.5 Flight Controller Interface

Two 2x10-pin 2.54-mm headers are provided to connect to a host processor board. This interface fits the LaunchPad LAUNCHXL-F28069F/M.

#### 2.1.5.1 Signal Description

On this interface, the following pins were used to provide signals to communicate with the flight controller from the C2000 processor.

The interface is compliant to 3.3-V I/O systems. The signals on the even pins are listed in [Table 2](#).

**Table 2. TIDA-00916 Interface Connector to Host MCU**

FUNCTION	SIGNAL	I/O [3V3]	COMMENT
Flight controller interface—duty cycle	Input	Digital input	Speed command using duty cycle PWM
Flight controller interface—serial interface	Input	Digital input	Speed command using serial interface
	Output	Digital output	Speed command using serial interface

For details on the connector pin assignment, see Section 6.

### 2.1.5.2 Tests of Flight Controller Interface

The interface of the duty cycle flight controller can be seen implemented in the TIDA-00643. For more details, see Section 5.3 of the [TIDA-00643 design guide, 4.4 to 30 V, 15 A, High Performance Brushless DC Propeller Controller Reference Design](#) (TIDUAK1).

### 2.1.5.3 Temperature and Size Estimation

For the ESC, system size and temperature are big concerns; in this design, due to the modules used these concerns have not been addressed.

For an initial estimation on the performance, see the TIDA-00643 TI Design. Within [this design guide](#) (TIDUAK1), see Section 7.2.4 for temperature measurements and Section 8 to find the download link of the TIDA-00643 design files.

### 2.1.6 Recommended Design Upgrades

Implement two ESCs using one LaunchPad and two BoosterPacks.

## 2.2 Software

The software used is based on [MotorWare](#). In MotorWare, first the LAB proj\_lab02c is used to identify the motor, then proj\_lab05h is used to generate the test data shown for the PID controller parameter definition.

For more information on how to use MotorWare with Code Composer Studio™ (CCS), read the document *InstaSPIN Projects and Labs User's Guide* (lit#).

### 2.2.1 Changing MotorWare Drivers for Changed BoosterPack

To match the required speed for the specific motor, the BoosterPack was adjusted, and those hardware modifications have to be reflected in MotorWare.

#### 2.2.1.1 Voltage Filter

The changes done to the voltage filter is described in [Section 4.3.1](#). This change has to be updated in the driver of the DRV8305 BoosterPack. This is done in the file user\_j1.h, using the variable:

```
#define USER_VOLTAGE_FILTER_POLE_Hz (344.62) // BOOSTXL-DRV8305 = 344.62 Hz
```

The value shown here is the default value for the DRV8305 BoosterPack. This value should now be changed to:

```
#define USER_VOLTAGE_FILTER_POLE_Hz (1044.30) // New voltage filter pole frequency
```

#### 2.2.1.2 Speed Filter

Due to the high-speed motor used, the pole for the software filter should also be adjusted:

```
#define USER_SPEED_POLE_rps (100.0) // 100.0 Default, do not change
```

Changing this filter can improve the high speed trajectory performance. This value can be adjusted to improve the high-speed performance of the ESC system. Setting this filter too high will introduce additional noise into the system.

### 2.2.2 Identifying the Motor

For source code of the software, download MotorWare and go through proj\_lab02c. This lab is built to identify PMSM motors with low inductance. After this lab, the motor parameters are in the following configuration: Rs, Lq, Ld, and Rated Flux. For more details on the values, see the [InstaSPIN-FOC™ and InstaSPIN-MOTION™ User's Guide](#) (SPRUHJ1).

To identify the motor, the following initial settings were used:

```
#define USER_MOTOR_TYPE           MOTOR_Type_Pm
#define USER_MOTOR_NUM_POLE_PAIRS (6)
#define USER_MOTOR_Rr             (NULL)
#define USER_MOTOR_Rs             (NULL)
#define USER_MOTOR_Ls_d           (NULL)
#define USER_MOTOR_Ls_q           (NULL)
#define USER_MOTOR_RATED_FLUX     (NULL)
#define USER_MOTOR_MAGNETIZING_CURRENT (NULL)
#define USER_MOTOR_RES_EST_CURRENT (1.0)
#define USER_MOTOR_IND_EST_CURRENT (-1.0)
#define USER_MOTOR_MAX_CURRENT    (15.0)
#define USER_MOTOR_FLUX_EST_FREQ_Hz (100.0)
```

With this definition in the user.h file, the motor was identified.

### 2.2.3 Generating the Step Response

To generate the step responses, use the lab proj\_lab05h. To use this lab, see the lab instructions located in the file instaspin\_labs.pdf. This file can be found under the documentation folder when installing MotorWare.

Generating these step responses will give the user the option to test the PI controller of the system. When generating the step response, the actual load used for the system must be connected to the motor. This will generate the most accurate data when running the motor.

Having this lab enables the user to adjust the control according to the system performance; see [Section 4](#) for more details on the adjustment of the current and speed controller to ensure the best performance.

### 2.2.4 Generating the Trajectory Curves

To generate the trajectory curves, proj\_lab05h was adapted to collect data for longer time. The acceleration and the step used was changed to the wanted max values required for the system.

When running the motor at the limit of the possible speed per voltage, proj\_lab09 or proj\_lab10 has to be used. The reason is that shunt measurements have to be ignored when the duty cycle is high, and these two labs have the necessary functions.

### 3 Getting Started Guide

#### 3.1 PCB Overview

Figure 6 and Figure 7 shows a photo of the top and bottom side of the LaunchPad and BoosterPack PCB. The headers and default jumper settings are explained in Section 3.2.

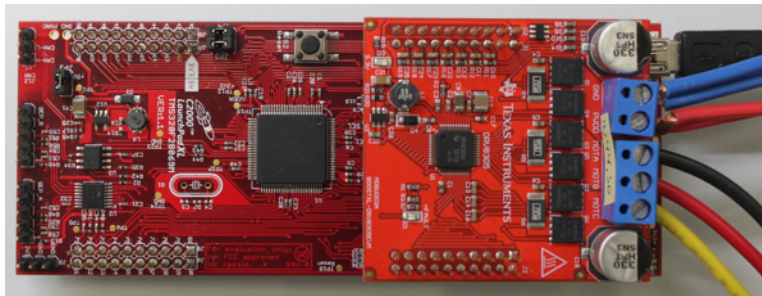

Figure 6. Board Picture of Complete System (Top View)

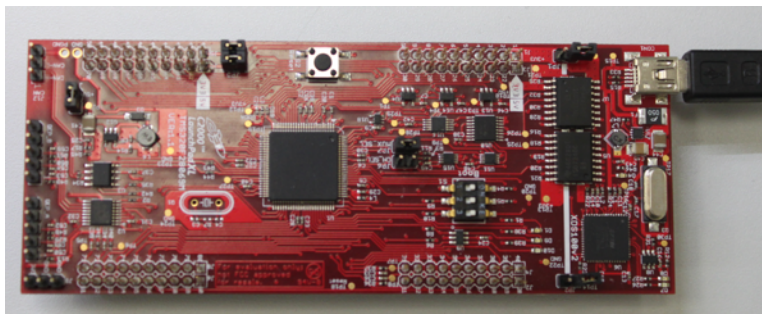

Figure 7. Board Picture of LaunchPad (Top View)

#### 3.2 Connector and Jumper Settings

##### 3.2.1 LaunchPad Configuration

When using the LAUNCHXL-F28069M, the following configuration of the LaunchPad board is necessary. The jumper settings are outlined in Table 3.

Table 3. LaunchPad Jumpers

PIN	CONNECTED	DESCRIPTION
JP1	Disconnected	Enable 3.3 V from USB (disables isolation)
JP2	Disconnected	Enable GND from USB (disables isolation)
JP3	Connected	Enable 5-V switcher (powered off 3.3-V supply of target device)
JP4	Disconnected	Connects target MCU 3.3 V to second set of BoosterPack headers
JP5	Disconnected	Connects target MCU 5 V to second set of BoosterPack headers
JP6	Disconnected	Pin Mux definition of GPIO15, GPIO28, GPIO29, and GPIO58
JP7	Disconnected	Pin Mux definition of GPIO15, GPIO28, GPIO29, and GPIO58

The S1 switch should be set to the ON-ON-ON position to allow for a JTAG debug connection. The header used to connect to the BoosterPack is J1 to J4. For more details on the LaunchPad, see [LAUNCHXL-F28069M Overview User's Guide](#) (SPRU111) and *Read Me First InstaSPIN-FOC and InstaSPIN-MOTION LaunchPad and BoosterPack*.

### 3.2.2 BoosterPack Configurations

Ensure the filter has been changed as described in [Section 2.1.3.1](#).

For more details on the BoosterPack, see the [BOOSTXL-DRV8305EVM User's Guide](#) (SLVUAI8).

## 3.3 Design Evaluation

### 3.3.1 Prerequisites

The following hardware equipment and software is required to allow evaluation of the TIDA-00916 TI Design.

**Table 4. Prerequisites**

EQUIPMENT	COMMENT
4- to 24-V adjustable power supply	Power supply with minimum 20-A output current
InstaSPIN-Motion F28069M LaunchPad	Available through TI eStore
DRV8305N Three-Phase Motor Drive BoosterPack	Available through TI eStore
TIDA-00916 source code	Download from TIDA-00916 design folder (link to <a href="#">MotorWare</a> )
USB cable	Needed to connect to LaunchPad
CCS 6.1.3 or newer	Download from <a href="http://www.TI.com">www.TI.com</a>

### 3.3.2 Hardware Setup

Ensure the jumpers on the LaunchPad are set as described in [Table 3](#).

Connect the BoosterPack header J1 and J2 to the LaunchPad J1 to J4 (see [Figure 6](#) and [Figure 7](#)).

Now connect a power supply to the screw terminal J3 and the three phase motor to J4 (see [Figure 6](#)).

### 3.3.3 Software Setup

When running the software, use the standard MotorWare framework with CCS. When running these examples, see the document *InstaSPIN Projects and Labs User's Guide* located in the document folder of MotorWare (motorware\_1\_01\_00\_xx\docs\labs).

This design guide uses the following examples:

- Proj\_lab2c
- Proj\_lab5h
- Proj\_lab9 or Proj\_lab10

### 3.3.4 User Interface

For details on the user interface in CCS, see the *InstaSPIN Projects and Labs User's Guide*.

## 4 Test Results

Tests are done to characterize each individual functional block as well as the entire board. In particular, the following tests were conducted:

- ESC Host Controller
  - Motor identification
  - PWM frequency used
- System Performance Tuning
  - No-load Step Response
  - Load step response
- System Performance Tests
  - RPM to electrical frequency
  - Speed performance acceleration and deceleration
- Motor Stator resistance can be used as temperature protection
  - Rs change of motor adjusted online
- Test Summary

Tests were done at room temperature around 22°C to 23°C, with a PWM of 45 kHz and a current controller running at 22.5 kHz.

The following equipment was used for the TIDA-00916 test session:

**Table 5. Test Equipment for TIDA-00916 Performance Tests**

TEST EQUIPMENT	PARTNUMBER
Adjustable power supply	TDK Lambda GEN20-38
High-speed oscilloscope (suitable for analog signal tests)	Tektronix TDS784C
Single-ended probes	Tektronix P6139A
Current probe	Tektronix A622
ESC motor	Turnigy Multistar 1704-1900Kv 12 Pole Multi-Rotor Outrunner V2
Propeller	5" x 4.5"



## 4.1 ESC Host Controller

Figure 8 shows a picture of the TIDA-00916 for load speed tests.

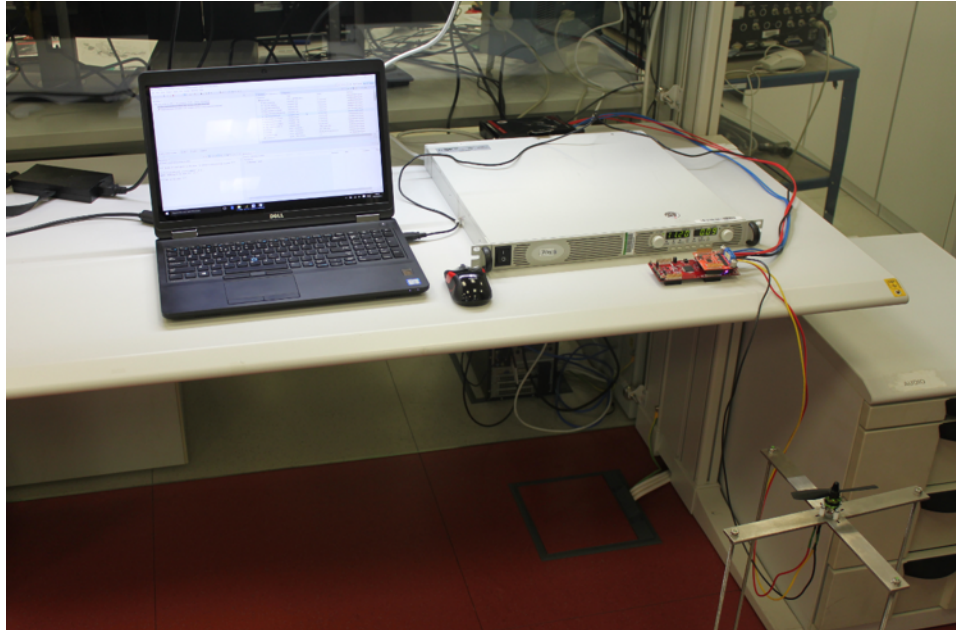

**Figure 8. Picture of Test Setup for TIDA-00916 Speed Tests**

### 4.1.1 Motor Identification

When identifying the motor parameters, the proj\_lab02c from MotorWare is used. The following motor parameters were identified:

```
#define USER_MOTOR_TYPE           MOTOR_Type_Pm
#define USER_MOTOR_NUM_POLE_PAIRS (6)
#define USER_MOTOR_Rs              (0.225925133)
#define USER_MOTOR_Ls_d            (1.57321483e-05)
#define USER_MOTOR_Ls_q            (1.57321483e-05)
#define USER_MOTOR_RATED_FLUX     (0.00297940802)
```

The additional motor values shown when using MotorWare are not used for PMSM motors. The rest of the values defined in the file user.h are used as set in [Section 2.2.2](#).



### 4.1.2 PWM Frequency Used

Figure 9 shows the PWM frequency outputted by InstaSPIN-FOC to the gate driver.

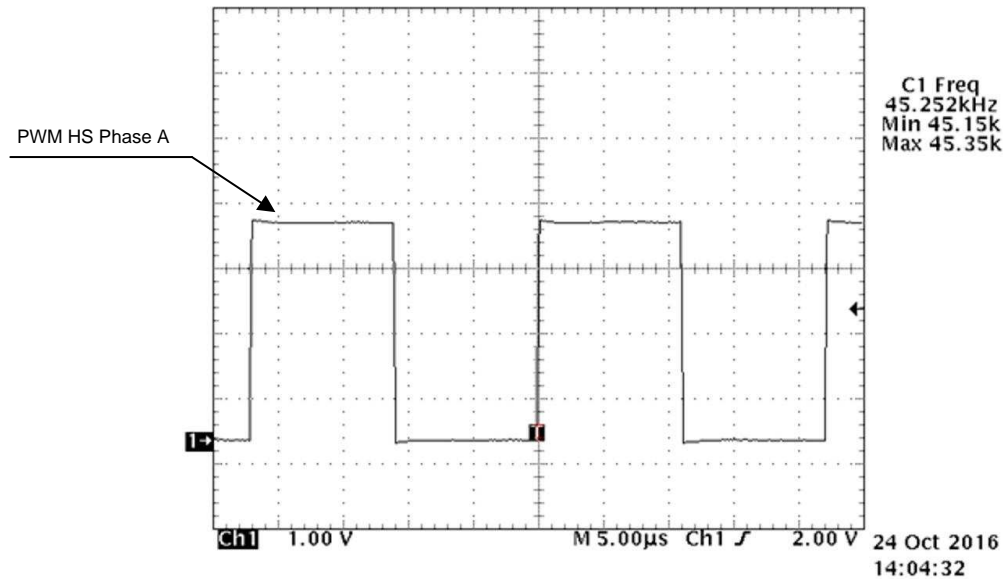

Figure 9. PWM Signal to Gate Driver

The frequency is around 45 kHz, which is also set in the software. For further measurements on the DRV8305 gate driver, see Section 7.1.2 of the [TIDA-00643 TI Design Guide \(TIDUAK1\)](#).

## 4.2 System Performance Tuning

The system performance tests are done both with and without a propeller attached. Here the tests show how the step response tuning was used to achieve stable high speed control.

### 4.2.1 No-Load Step Response

The motor tested was the Turnigy Multistar 1704-1900Kv 12 Pole Multi-Rotor Outrunner V2. The motor was tested with a  $V_{BUS}$  equal to 11.2 V under no load using proj\_lab05h from MotorWare. With this configuration, the following results were obtained.

Figure 10 shows the  $I_d$  current controller PI step response.

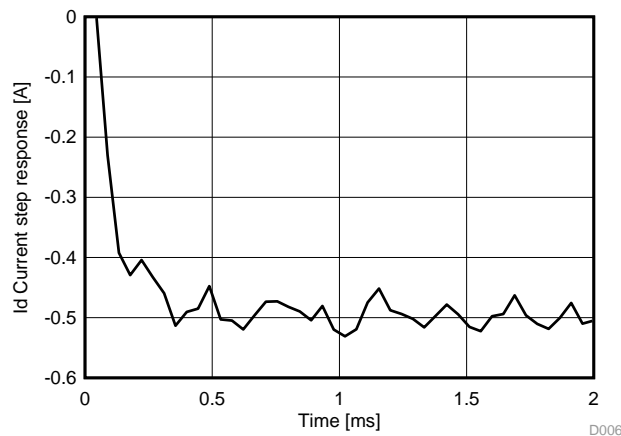
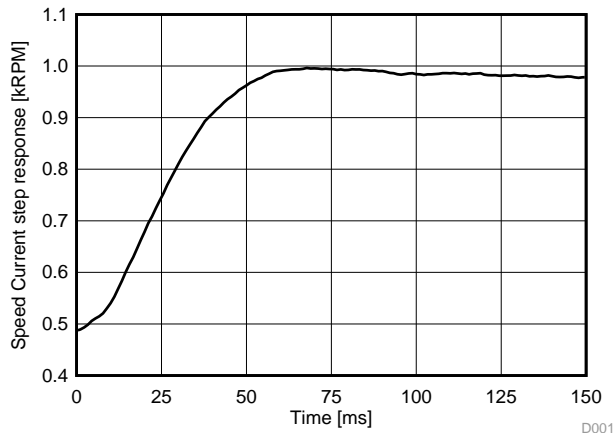

Figure 10.  $I_d$  PI Current Controller Step Response Without the Propeller

Figure 11 shows the speed controller PI step response.



**Figure 11. PI Speed Controller Small Signal Step Response Without the Propeller**

The step responses generated were achieved using the following  $K_p$ ,  $K_i$  values for the current and speed controller.

**Table 6. PI Controller Parameters to Generate No-Load Step Responses**

CONTROLLER	$K_p$	$K_i$
Current controller at 22.5 kHz	0.35	0.5900
Speed controller at 1.5 kHz	0.27	0.0001

With these PI controller parameters, the following speed stability was shown for 12 kRPM.

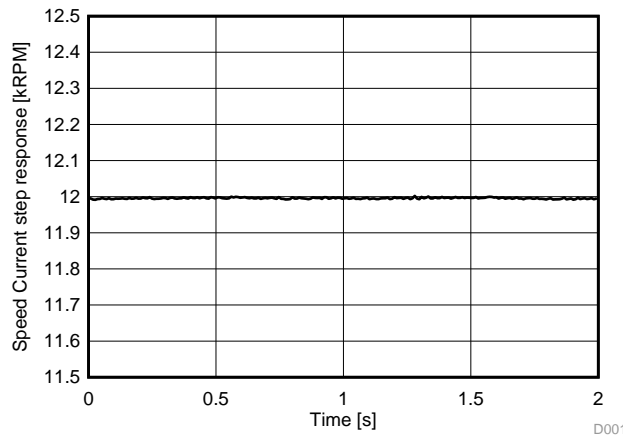

**Figure 12. 12-kRPM Speed Stability Performance (No Load)**

### 4.2.2 Step Response With Load

Load the motor of the ESC by adding the propeller to the motor shaft as seen in [Figure 13](#).

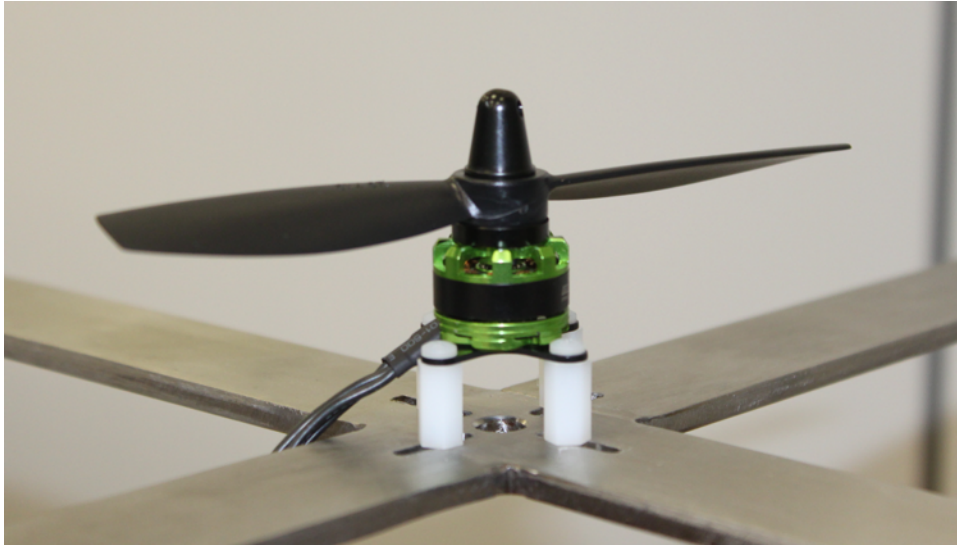

**Figure 13. Picture of Motor With Propeller Attached**

The load tests were done using a 5" x 4.5" propeller. With this propeller attached on the motor using  $V_{BUS}$  equal to 11.2 V, the following results were achieved.

[Figure 14](#) shows the current controller PI step response.

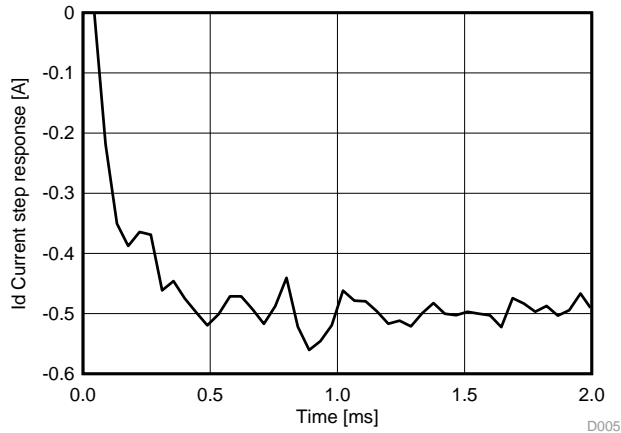

**Figure 14. PI Current Controller Step Response With the Propeller**

Figure 15 shows the speed controller PI step response.

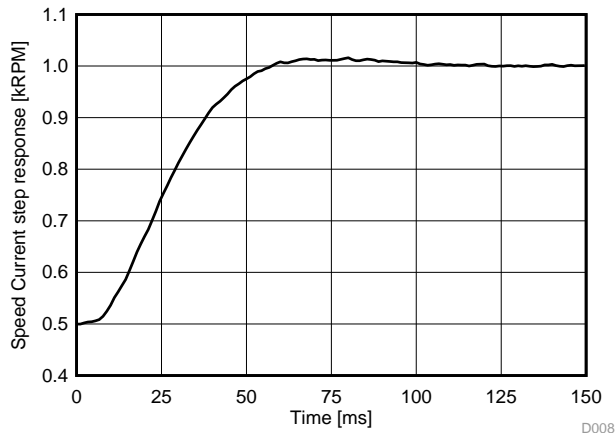

**Figure 15. PI Speed Controller Small Signal Step Response With the Propeller**

The step responses generated were achieved using the following  $K_p$ ,  $K_i$  values for the current and speed controller.

**Table 7. PI Controller Parameters to Generate Step Responses With Propeller Load**

CONTROLLER	$K_p$	$K_i$
Current controller at 22.5 kHz	0.38	0.530
Speed controller at 1.5 kHz	2.50	0.002

Figure 16 shows the speed controller PI step response.

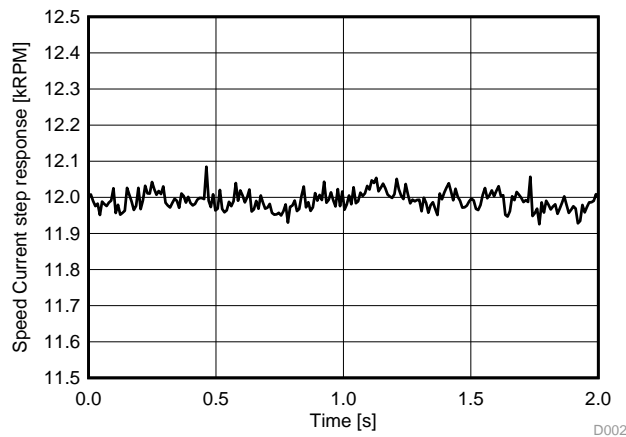

**Figure 16. 12-kRPM Speed Stability Performance With Propeller**

### 4.3 System Performance Tests

The system performance tests are done with motor without attached propeller and with attached propeller. Here, the tests are to show the maximum speed change possible and the maximum speed stability.

#### 4.3.1 RPM to Electrical Frequency

To ensure that the translation from RPM to electrical frequency is correct, a plot was made, which shows the electrical frequency of the motor at 12 kRPM. This frequency should be 1.2 kHz (see Equation 3).

The frequency is around 1.65 box per sinus wave, which this corresponds to.

$$f = \frac{1}{1.65 \times 500 \mu\text{s}} \approx 1.2 \text{ kHz} \tag{3}$$

The chosen motor most likely have a trapezoidal back-EMF, which disturbs the current from a perfect sinusoid. This also reduces the efficiency of the system, compared to running the motor with a sinusoidal wound motor.

#### 4.3.2 Speed Performance Acceleration and Deceleration

To achieve acceleration to the maximum speed without overshoot, the following acceleration was chosen.

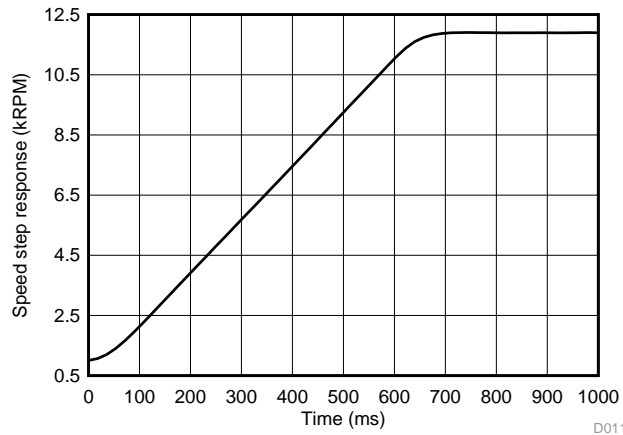

**Figure 17. Speed Trajectory With 36 kRPM From 1 to 12 kRPM Without the Propeller**

To achieve the wanted speed trajectory with the propeller, adaptation of the speed PI controller was necessary. The small-signal step response of the adapted speed controller is seen in Figure 18.

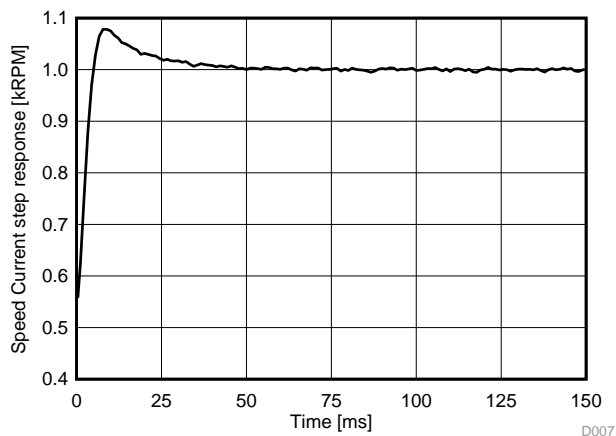
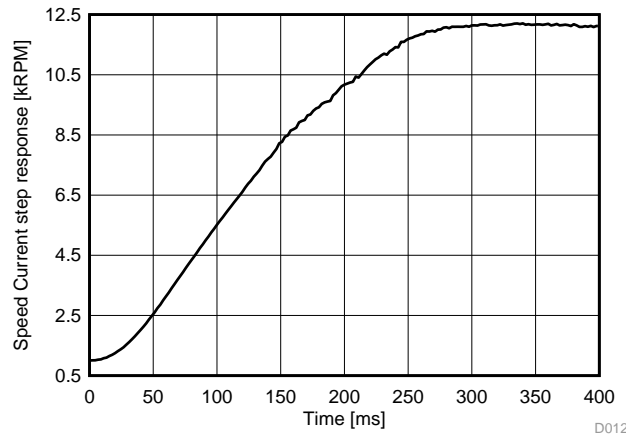

**Figure 18. PI Speed Controller Small-Signal Step Response With the Propeller for High Trajectory**

The step responses generated were achieved using the following  $K_p$ ,  $K_i$  values for the current and speed controller.

**Table 8. PI Controller Parameters to Generate the Step Responses for Optimized Trajectory**

CONTROLLER	$K_p$	$K_i$
Current controller at 22.5 kHz	0.38	0.5300
Speed controller at 1.5 kHz	2.50	0.0125



**Figure 19. Speed Trajectory With 56 kRPM From 1 To 12 kRPM With the Propeller**

To test the maximum speed, this was also done from 1 to 8  $k_{RPM}$  with a 86 $k_{RPM}$  trajectory.

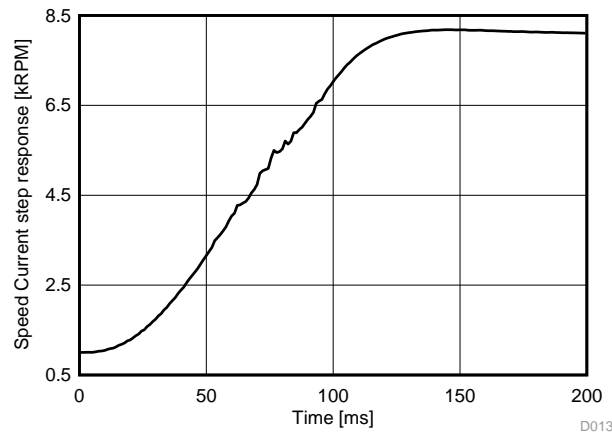

**Figure 20. Speed Trajectory With 86 kRPM From 1 to 8 kRPM With the Propeller**

To test speed reversal, an adaptive speed controller was used. It changed the PI controller parameters compared to how fast the motor was running. This is done to improve performance around zero speed. The result can be seen in [Figure 21](#).

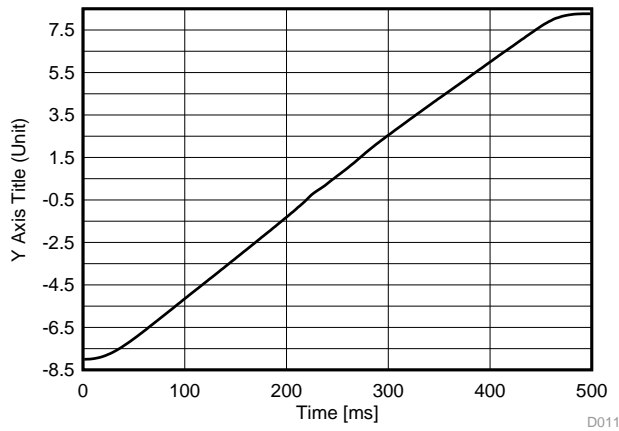

**Figure 21. Speed Trajectory With 36 kRPM From -8 to 8 kRPM With the Propeller**

#### 4.4 Motor Stator Resistance as Temperature Protection

Rs can change of the motor at 2 kRPM and 8 kRPM. This was not done at 12 kRPM as the motor was overheating.

##### 4.4.1 Rs Change of Motor Adjusted Online

When running the motor at its maximum, the motor will be heating up. This changes the resistance of the stator of the motor. Compensate for this change to ensure good performance of the motor control. Using InstaSPIN-FOC, the resistance of the motor can be measured and compensated to have the best performance of the sensorless algorithm.

This feature can be enabled by using proj\_lab7 of MotorWare. The following test has been done showing the Rs online change with a running motor at 2 kRPM and 8 kRPM to see the temperature change measured with Rs online measurement.

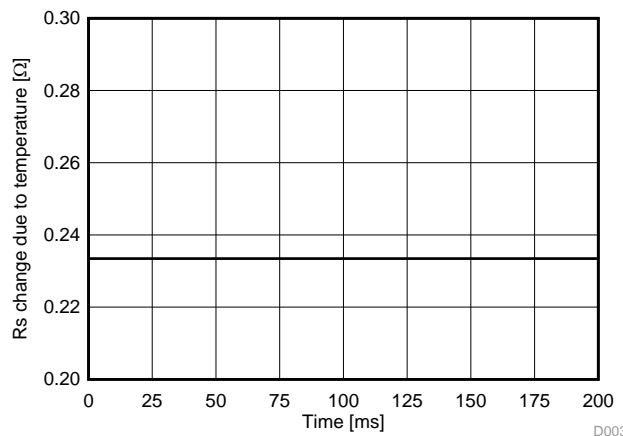

**Figure 22. Graph Showing Rs Online Change Over Time Running the Motor at 2 kRPM**

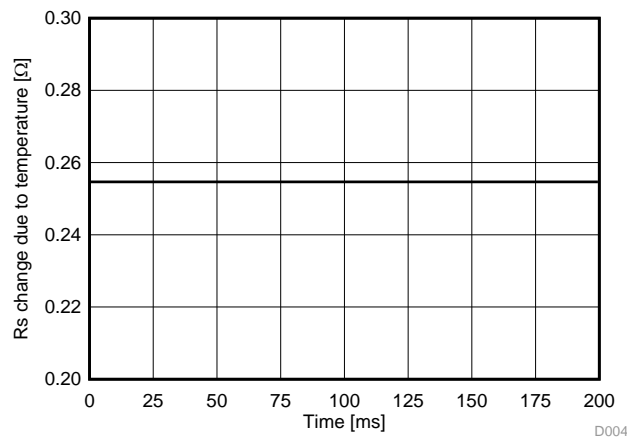

**Figure 23. Graph Showing Rs Online Change Over Time Running the Motor at 8 kRPM**

With a higher speed, the motor heats up. This feature could be used to protect the motor from overheating and ultimately breaking down.

#### 4.5 Test Summary

This TI Design shows how to adapt InstaSPIN-FOC to enable high-speed motor control using TI provided software. This is done by using the special capabilities of the C2000 processor family for advanced system debug capability. This can supplement the simulation effort of the engineers to not need to develop the perfect simulation tool for the system, but simply use the actual hardware to debug the control algorithm issue. This removes the need to build complex simulation algorithms to define specific motor or PCB parasitic effects to the system.

The C2000 device can run a full FOC, sensorless, speed, and current closed loop control system up to 1.2 kHz electrically or higher, using TI provided software (namely, MotorWare).



## 5 Design Files

### 5.1 Schematics

To download the schematics for each board, see the design files at [TIDA-00916](#).

### 5.2 Bill of Materials

To download the bill of materials for each board, see the design files [TIDA-00916](#).

### 5.3 PCB Layout Prints

To download the layout prints for each board, see the design files at [TIDA-00916](#).

### 5.4 Altium Project

To download the Altium project files for each board, see the design files at [TIDA-00916](#).

### 5.5 Gerber Files

To download the Gerber files for each board, see the design files at [TIDA-00916](#).

### 5.6 Assembly Drawings

To download the assembly drawings for each board, see the design files at [TIDA-00916](#).

## 6 Software Files

For the source code, download the MotorWare v17 from <http://www.ti.com/motorware>.

## 7 References

1. Texas Instruments, DRV8305, Three Phase Gate Driver with Three Integrated Current Shunt Amplifiers, <http://www.ti.com/product/drv8305>
2. Texas Instruments, TMS320F28069M, Piccolo Microcontroller with InstaSPIN-MOTION, <http://www.ti.com/product/tms320f28069m>
3. Texas Instruments, LMR16006, SIMPLE SWITCHER® 4V to 60V, 600mA Step-Down Regulator with Low Iq, <http://www.ti.com/product/lmr16006>
4. Texas Instruments, LAUNCHXL-F28069M, C2000 Piccolo F28069M LaunchPad, <http://www.ti.com/tool/launchxl-f28069m>
5. Texas Instruments, BOOSTXL-DRV8305EVM, DRV8305N 3-Phase Motor Drive BoosterPack, <http://www.ti.com/tool/BOOSTXL-DRV8305EVM>
6. Texas Instruments, TIDA-00643, *4.4 to 30 V, 15 A, High Performance Brushless DC Propeller Controller Reference Design*, TIDA-00643 Design Guide (TIDUAK1)
7. Texas Instruments, *InstaSPIN-FOC™ and InstaSPIN-MOTION™ User's Guide* (SPRUHJ1)
8. Richard Poley, Control Theory Fundamentals, ISBN-13: 978-1496040732
9. Texas Instruments, Motor Control Compendium, [http://focus.ti.com/download/trng/docs/c2000/TI\\_MotorControlCompendium\\_2010.pdf](http://focus.ti.com/download/trng/docs/c2000/TI_MotorControlCompendium_2010.pdf)

## 8 About the Author

**KRISTEN MOGENSEN** is a system engineer in the Industrial Systems-Motor Drive team at Texas Instruments, responsible for developing reference designs for industrial drives.

### 8.1 Recognition

The author would like to recognize the excellent contributions from **MARTIN STAEBLER** and **PAL BOELE** during the design and documentation phase of the TIDA-00916 design.

## IMPORTANT NOTICE FOR TI DESIGN INFORMATION AND RESOURCES

Texas Instruments Incorporated ("TI") technical, application or other design advice, services or information, including, but not limited to, reference designs and materials relating to evaluation modules, (collectively, "TI Resources") are intended to assist designers who are developing applications that incorporate TI products; by downloading, accessing or using any particular TI Resource in any way, you (individually or, if you are acting on behalf of a company, your company) agree to use it solely for this purpose and subject to the terms of this Notice.

TI's provision of TI Resources does not expand or otherwise alter TI's applicable published warranties or warranty disclaimers for TI products, and no additional obligations or liabilities arise from TI providing such TI Resources. TI reserves the right to make corrections, enhancements, improvements and other changes to its TI Resources.

You understand and agree that you remain responsible for using your independent analysis, evaluation and judgment in designing your applications and that you have full and exclusive responsibility to assure the safety of your applications and compliance of your applications (and of all TI products used in or for your applications) with all applicable regulations, laws and other applicable requirements. You represent that, with respect to your applications, you have all the necessary expertise to create and implement safeguards that (1) anticipate dangerous consequences of failures, (2) monitor failures and their consequences, and (3) lessen the likelihood of failures that might cause harm and take appropriate actions. You agree that prior to using or distributing any applications that include TI products, you will thoroughly test such applications and the functionality of such TI products as used in such applications. TI has not conducted any testing other than that specifically described in the published documentation for a particular TI Resource.

You are authorized to use, copy and modify any individual TI Resource only in connection with the development of applications that include the TI product(s) identified in such TI Resource. NO OTHER LICENSE, EXPRESS OR IMPLIED, BY ESTOPPEL OR OTHERWISE TO ANY OTHER TI INTELLECTUAL PROPERTY RIGHT, AND NO LICENSE TO ANY TECHNOLOGY OR INTELLECTUAL PROPERTY RIGHT OF TI OR ANY THIRD PARTY IS GRANTED HEREIN, including but not limited to any patent right, copyright, mask work right, or other intellectual property right relating to any combination, machine, or process in which TI products or services are used. Information regarding or referencing third-party products or services does not constitute a license to use such products or services, or a warranty or endorsement thereof. Use of TI Resources may require a license from a third party under the patents or other intellectual property of the third party, or a license from TI under the patents or other intellectual property of TI.

TI RESOURCES ARE PROVIDED "AS IS" AND WITH ALL FAULTS. TI DISCLAIMS ALL OTHER WARRANTIES OR REPRESENTATIONS, EXPRESS OR IMPLIED, REGARDING TI RESOURCES OR USE THEREOF, INCLUDING BUT NOT LIMITED TO ACCURACY OR COMPLETENESS, TITLE, ANY EPIDEMIC FAILURE WARRANTY AND ANY IMPLIED WARRANTIES OF MERCHANTABILITY, FITNESS FOR A PARTICULAR PURPOSE, AND NON-INFRINGEMENT OF ANY THIRD PARTY INTELLECTUAL PROPERTY RIGHTS.

TI SHALL NOT BE LIABLE FOR AND SHALL NOT DEFEND OR INDEMNIFY YOU AGAINST ANY CLAIM, INCLUDING BUT NOT LIMITED TO ANY INFRINGEMENT CLAIM THAT RELATES TO OR IS BASED ON ANY COMBINATION OF PRODUCTS EVEN IF DESCRIBED IN TI RESOURCES OR OTHERWISE. IN NO EVENT SHALL TI BE LIABLE FOR ANY ACTUAL, DIRECT, SPECIAL, COLLATERAL, INDIRECT, PUNITIVE, INCIDENTAL, CONSEQUENTIAL OR EXEMPLARY DAMAGES IN CONNECTION WITH OR ARISING OUT OF TI RESOURCES OR USE THEREOF, AND REGARDLESS OF WHETHER TI HAS BEEN ADVISED OF THE POSSIBILITY OF SUCH DAMAGES.

You agree to fully indemnify TI and its representatives against any damages, costs, losses, and/or liabilities arising out of your non-compliance with the terms and provisions of this Notice.

This Notice applies to TI Resources. Additional terms apply to the use and purchase of certain types of materials, TI products and services. These include; without limitation, TI's standard terms for semiconductor products (<http://www.ti.com/sc/docs/stdterms.htm>), [evaluation modules](#), and [samples](http://www.ti.com/sc/docs/sampterm.htm) (<http://www.ti.com/sc/docs/sampterm.htm>).

Mailing Address: Texas Instruments, Post Office Box 655303, Dallas, Texas 75265  
Copyright © 2018, Texas Instruments Incorporated