

EQ50F100 1Gbps - 6.25 Gbps Backplane Equalizer

Check for Samples: [EQ50F100](#)

FEATURES

- Recovers 6.25 Gbps signals after 30" of FR4
- Single 1.8V power supply
- Low power consumption: 85mW
- Equalize up to 20dB loss at 2.5 GHz
- 35 ps residual deterministic jitter at 5 Gbps
- On-chip CML terminations
- Small 3 mm x 3 mm 6–pin leadless LLP package

DESCRIPTION

The EQ50F100 is a equalizer designed to compensate transmission medium losses and reduce the medium-induced deterministic jitter. It is optimized for operation from 1Gbps to 6.25Gbps, on printed circuit backplane for up to 30" of FR4 striplines with backplane connectors at both ends. It is code independent, and functioning equally well for short run length, balanced codes such as 8b/10b, commonly used in multiplexed 1.25 Gbps Ethernet Systems.

The equalizer uses differential CML inputs and outputs with feed-through pin-outs, mounted in a 3 mm x 3 mm 6–pin leadless LLP package. It is powered from single 1.8V supply and consumes 85 mW.

PRODUCT PREVIEW

Please be aware that an important notice concerning availability, standard warranty, and use in critical applications of Texas Instruments semiconductor products and disclaimers thereto appears at the end of this data sheet.

All trademarks are the property of their respective owners.

PRODUCT PREVIEW information concerns products in the formative or design phase of development. Characteristic data and other specifications are design goals. Texas Instruments reserves the right to change or discontinue these products without notice.

Copyright © 2004–2005, Texas Instruments Incorporated

Simplified Function Diagram

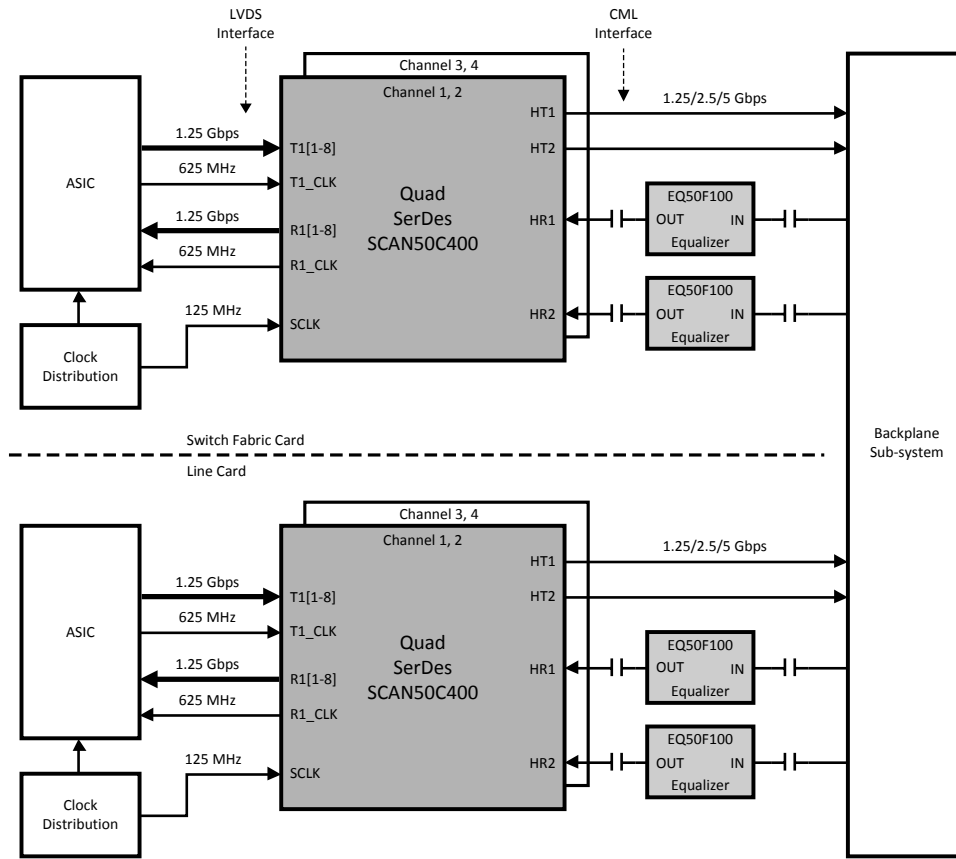

Note: Information contained in this datasheet is subject to change due to changes in design, specification and/or process, before EQ50F100 is production released.

PRODUCT PREVIEW

Simplified Block Diagram

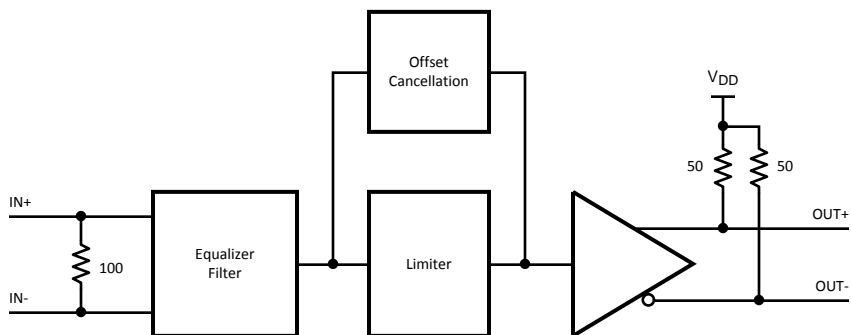

Pin Functions

Pin Descriptions

Pin Name	Pin Number	I/O, Type	Description
HIGH SPEED DIFFERENTIAL I/O			
IN- IN+	1 6	I, CML	Inverting and non-inverting CML differential inputs to the equalizer. An on-chip 100Ω terminating resistor is connected between IN+ and IN-.
OUT- OUT+	3 4	O, CML	Inverting and non-inverting CML differential outputs from the equalizer. An on-chip 50Ω terminating resistor connects OUT+ to V _{DD} and OUT- to V _{DD} .
POWER			
V _{DD}	5	I, Power	V _{DD} = 1.8V ± 5%. V _{DD} pins should be tied to V _{DD} plane through low inductance path. A 0.01 μF bypass capacitor should be connected between the V _{DD} pin and the GND planes.
GND	2	I, Power	Ground reference. GND should be tied to a solid ground plane through a low impedance path.
Exposed Pad	PAD	I, Power	Connect to GND. The exposed pad at the center of the package should be connected to ground plane of the board to enhance thermal and electrical performance of the package.

PRODUCT PREVIEW

Pin Diagram

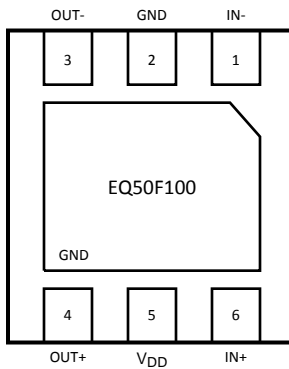

**Figure 1. Top View Shown
3 mm x 3 mm 6-Pin LLP Package**



These devices have limited built-in ESD protection. The leads should be shorted together or the device placed in conductive foam during storage or handling to prevent electrostatic damage to the MOS gates.

Absolute Maximum Ratings ⁽¹⁾

Supply Voltage (V_{DD})	-0.3V to +2.5V
CML Input/Output Voltage	-0.3V to ($V_{DD} + 0.3V$)
Junction Temperature	+150°C
Storage Temperature	-65°C to +150°C
Lead Temp. (Soldering, 5 sec.)	+260°C
ESD Rating	
HBM, 1.5 k Ω , 100 pF	>7 kV
EIAJ, 0 Ω , 200 pF	>200V
Thermal Resistance θ_{JA} , No Airflow	54°C/W

(1) "Absolute Maximum Ratings" are the ratings beyond which the safety of the device cannot be guaranteed. They are not meant to imply that the device should be operated at these limits.

Recommended Operating Conditions

	Min	Typ	Max	Units
Supply Voltage (V_{DD} to GND)	1.71	1.8	1.89	V
Ambient Temperature	-40	25	85	°C

Electrical Characteristics

Over recommended operating supply and temperature ranges unless other specified.

Symbol	Parameter	Conditions	Min	Typ (1)	Max	Units
POWER						
P	Power Supply Consumption			85	106	mW
N	Supply Noise Tolerance ⁽²⁾	10 Hz–100 Hz 100 Hz–10 MHz 10 MHz–2.5 GHz		100 50 10		mV _{P-P} mV _{P-P} mV _{P-P}
CML RECEIVER INPUTS (IN+, IN-)						
V _{IN}	Input Voltage Swing	Differential signal to equalizer, measured before test channel	400		1600	mV _{P-P}
R _{LI}	Differential Input Return Loss	100 MHz–2.5 GHz, with fixture's effect de-embedded		15		dB
R _{IN}	Input Resistance	Differential across IN+ and IN-	85	100	115	Ω
CML OUTPUTS (OUT+, OUT-)						
V _O	Output Voltage Swing	Measured differentially with OUT+ and OUT- terminated by 50Ω to GND through DC block ⁽³⁾ ⁽⁴⁾	450		800	mV _{P-P}
t _R , t _F	Transition Time	20% to 80% of differential output voltage, measured with 1" from output pins. ⁽³⁾ ⁽⁴⁾	30	45	60	ps
R _O	Output Resistance	Single-ended to V _{DD}	42	50	58	Ω
R _{LO}	Differential Output Return Loss	100 MHz–2.5 GHz, with fixture's effect de-embedded. IN+ = static high.		14		dB
EQUALIZATION						
DJ1	Residual Deterministic Jitter at 6.25 Gb/s	Multiplexed K28.5 pattern, ⁽⁵⁾ ⁽⁶⁾ 30" Test channel, V _{IN} = 1V _{P-P} . ⁽⁴⁾		0.25	0.4	UI _{P-P}
DJ2	Residual Deterministic Jitter at 5 Gb/s	Multiplexed K28.5 pattern, ⁽⁷⁾ ⁽⁶⁾ 30" Test channel. V _{IN} = 1V _{P-P} . ⁽⁴⁾		0.13	0.35	UI _{P-P}
DJ3	Residual Deterministic Jitter at 2.5 Gb/s	Multiplexed K28.5 pattern, ⁽⁸⁾ ⁽⁶⁾ 30" Test channel, V _{IN} = 1V _{P-P} . ⁽⁴⁾		0.09	0.2	UI _{P-P}

(1) Typical parameters are measured at V_{DD} = 1.8V, T_A = 25°C. They are for reference purposes, and are not production-tested.

(2) Allowed supply noise (mV_{P-P} sine wave) during jitter tests.

(3) Test pattern is clock-like 11111 00000 pattern.

(4) V_O, t_R, t_F, t_D, DJ1, DJ2, DJ3, DJ4 and RJ specifications are Guaranteed by Design using statistical analysis.

(5) Test pattern at 6.25 Gbps is a combination of K28.5± characters running at full bit rate and at half bit rate. It is intended to simulate the multiplexing of two 3.125 Gb/s channels of a XAUI data stream.

Pattern in hex

0F FCCF 0033 (quarter rate of K28.5+, half rate of K28.5-)

3 EB05 (full rate K28.5±: 00 1111 1010 11 0000 0101)

(6) Deterministic jitter is measured at the differential outputs, minus the deterministic jitter before the test channel. Random jitter is removed through the use of averaging or similar means.

(7) Test pattern at 5 Gbps is a combination of K28.5± characters running at full bit rate and at quarter bit rate. It is intended to simulate the multiplexing of four 1.25 Gb/s Ethernet data streams.

Pattern in hex

00 FFFF F0F0 FF 0000 0F0F (quarter rate of K28.5+, quarter rate of K28.5-)

3 EB05 (full rate K28.5±: 00 1111 1010 11 0000 0101)

(8) Test pattern at 2.5 Gbps is a combination of K28.5± characters running at full bit rate and at half bit rate. It is intended to simulate the multiplexing of two 1.25 Gb/s Ethernet data streams.

Pattern in hex

0F FCCF 0033 (half rate of K28.5+, half rate of K28.5-)

3 EB05 (full rate K28.5±: 00 1111 1010 11 0000 0101)

Electrical Characteristics (continued)

Over recommended operating supply and temperature ranges unless other specified.

Symbol	Parameter	Conditions	Min	Typ (1)	Max	Units
DJ4	Residual Deterministic Jitter at 1.25 Gb/s	Multiplexed K28.5 pattern, ⁽⁹⁾ ⁽⁶⁾ 30" Test channel, $V_{IN} = 1V_{P.P.}$ ⁽⁴⁾		0.04	0.15	UI _{P-P}
RJ	Random Jitter	⁽³⁾ ⁽¹⁰⁾ ⁽⁴⁾		0.75	1.0	psrms
LATENCY						
t_D	Latency	Measured from input to output, measured with multiplexed K28.5 pattern at 5Gb/s. ⁽⁷⁾ ⁽⁴⁾	150	230	300	ps
BIT RATE						
BRMIN	Minimum Bit Rate			1		Gbps
BRMAX	Maximum Bit Rate			6.25		Gbps

(9) Test pattern at 1.25 Gbps is K28.5± characters running at full bit rate

Pattern in hex

3 EB05 (full rate K28.5±: 00 1111 1010 11 0000 0101)

(10) Random jitter contributed by the equalizer is defined as $\text{sq rt} (J_{OUT}^2 - J_{IN}^2)$. J_{OUT} is the random jitter at equalizer outputs in ps-rms, J_{IN} in the random jitter at the input of the equalizer in ps-rms.

Test Setup Diagram

TEST CHANNEL USED IN PRODUCTION TEST, TYPICAL EYE DIAGRAMS

The test channel used in production test and typical eye diagram is a FR4 stripline test channel that can be practically implemented in production load board environment, and yet with loss characteristics similar to a backplane that intended to test the device's equalization span.

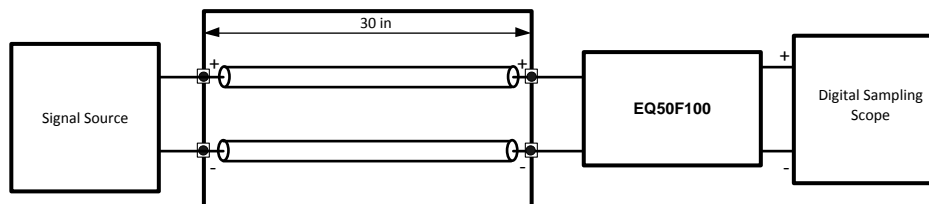

Functional Description

The EQ50F100 6.25Gbps Backplane Equalizer is a fixed, receive-end backplane equalizer. It enables serial transmission over FR-4 backplane with trace length of at least 30" at 6.25Gbps. It consists of an equalizer filter, limiting amplifier, offset driver, and offset cancellation circuit. The equalizer block compensates for the high frequency attenuation caused by the bandwidth-limited transmission channel found in backplane system. The limiting amplifier boost the signal at the output of the equalizer block. The offset cancellation circuit corrects for internal mis-match and offset from the previous stage to minimize duty-cycle distortion.

Input and Output

The input and output stage of the EQ50F100 is implemented using current mode logic (CML). The input stage has an equivalent DC differential input resistance of 100Ω. The positive and negative output channels are internally terminated with a 50Ω pull-up to VDD. AC coupling is recommended for both input and output.

Application Information

PCB LAYOUT AND POWER SYSTEM CONSIDERATIONS

Power system performance may be greatly improved by using thin dielectrics (2 to 4 mils) for power / ground sandwiches. This arrangement provides plane capacitance for the PCB power system with low-inductance parasitic. External bypass capacitors should include both RF ceramic and tantalum electrolytic types. RF capacitors may use values in the range of 0.1nF to 10nF. Tantalum capacitors may be in the 2.2uF to 10uF range. Voltage rating of the tantalum capacitors should be at least 5X the power supply voltage being used.

It is a recommended practice to use two vias at each power pin as well as at all RF bypass capacitor terminals. Dual vias reduce the interconnect inductance by up to half, thereby reducing interconnect inductance and extending the effective frequency range of the bypass components. Locate RF capacitors as close as possible to the supply pins, and use wide low impedance traces (not 50 Ohm traces). Surface mount capacitors are recommended due to their smaller parasitics. It is recommended to connect power and ground pins directly to the power and ground planes with bypass capacitors connected to the plane with via on both ends of the capacitor. Connecting power or ground pins to an external bypass capacitor will increase the inductance of the path.

A small body size X7R chip capacitor, such as 0603 or 0402, is recommended for external bypass. Its small body size reduces the parasitic inductance of the capacitor. The user must pay attention to the resonance frequency of these external bypass capacitors, usually in the range of 20-30 MHz range. To provide effective bypassing, multiple capacitors are often used to achieve low impedance between the supply rails over the frequency of interest. At high frequency, it is also a common practice to use two vias from power and ground pins to the planes, reducing the impedance at high frequency.

See AN-1187 for additional information on LLP package.

AC COUPLING

For multi-giga bit design, the smallest available package should be used for the AC coupling capacitor. This will help minimize degradation of signal quality due to package parasitics. The most common used capacitor value for the EQ50F100 interface is 0.1uF capacitor.

Typical Performance Characteristics

TYPICAL EYE DIAGRAM WITH 30" BACKPLANE CHARACTERISTICS

All typical eye diagrams are measured with a FR4 stripline test channel at $V_{DD} = 1.8V$, $T_A = 25^\circ C$ with PRBS-10 pattern at 1Vp-p at the source. They were acquired by an oscilloscope with 2k sampling hits, which includes approximately 10ps of system jitter. ⁽¹⁾

Figure 2. 1.25 Gb/s, PRBS-10 *Input* Signal to Equalizer after 30" of FR4

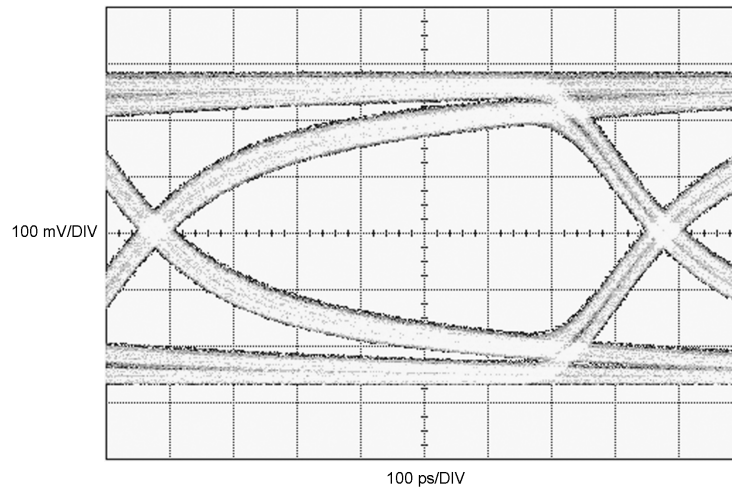

Figure 3. Typical 1.25 Gb/s Equalizer *Output* Signal, with Input as shown in Figure 2

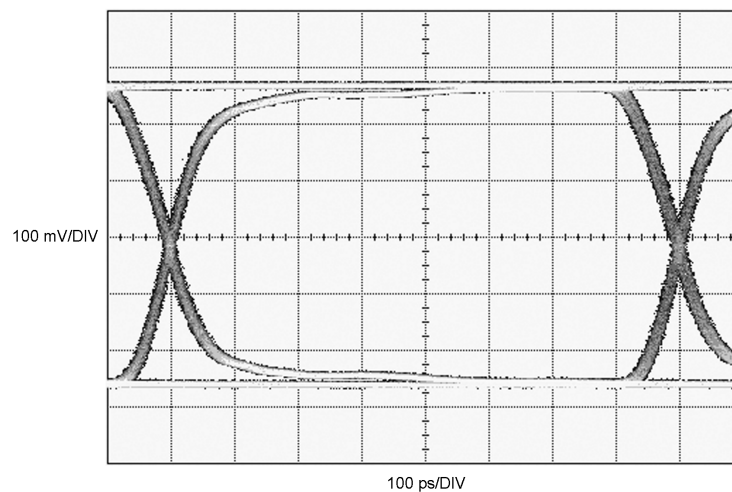

Figure 4. 2.5 Gb/s, PRBS-10 *Input* Signal to Equalizer after 30" of FR4

(1) Typical parameters are measured at $V_{DD} = 1.8V$, $T_A = 25^\circ C$. They are for reference purposes, and are not production-tested.

Typical Performance Characteristics (continued)

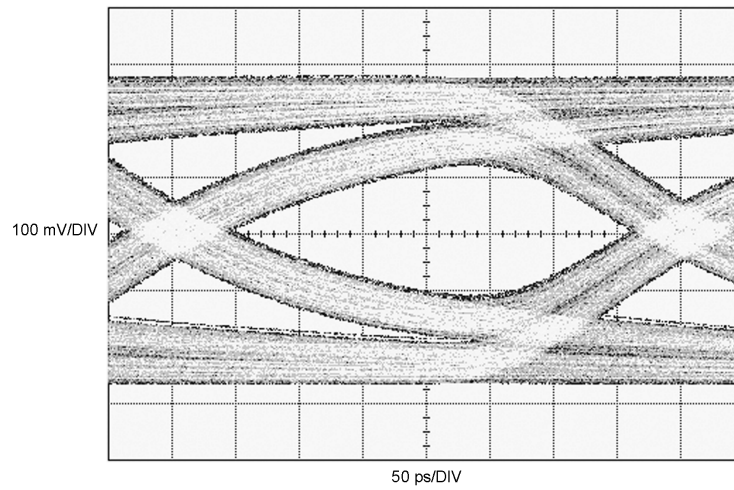

Figure 5. Typical 2.5Gb/s Equalizer *Output* Signal, with Input as shown in [Figure 4](#)

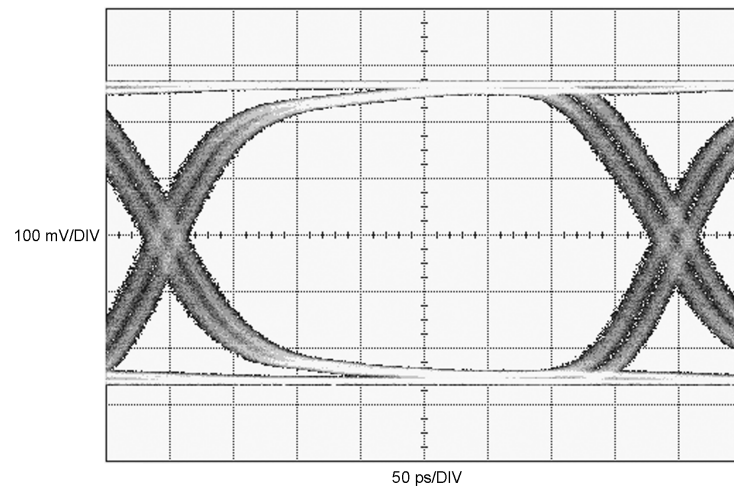

Figure 6. 5 Gb/s, PRBS-10 *Input* Signal to Equalizer after 30" of FR4

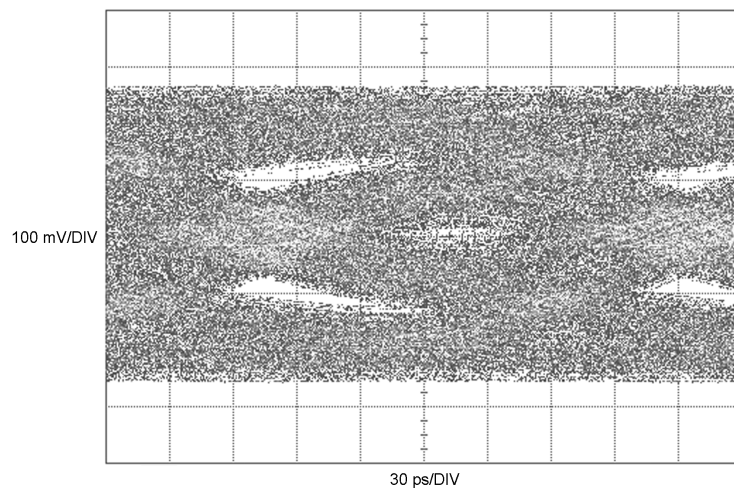

Figure 7. Typical 5Gb/s Equalizer *Output* Signal, with Input as shown in [Figure 6](#)

PRODUCT PREVIEW

Typical Performance Characteristics (continued)

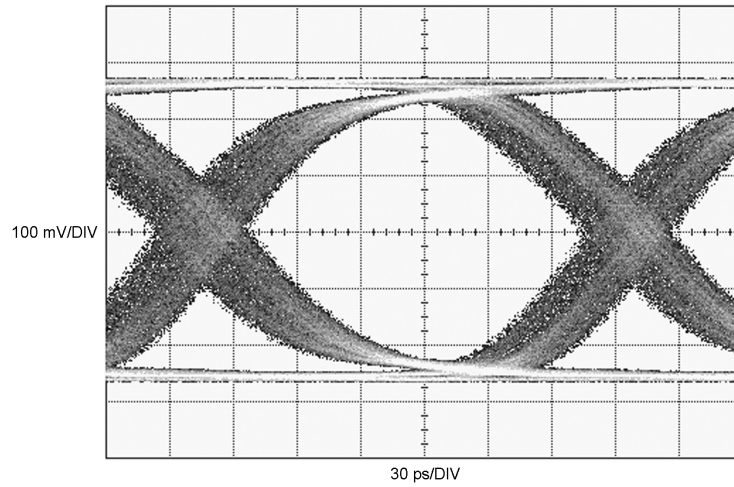

Figure 8. 6.25 Gb/s, PRBS-10 *Input* Signal to Equalizer after 30" of FR4

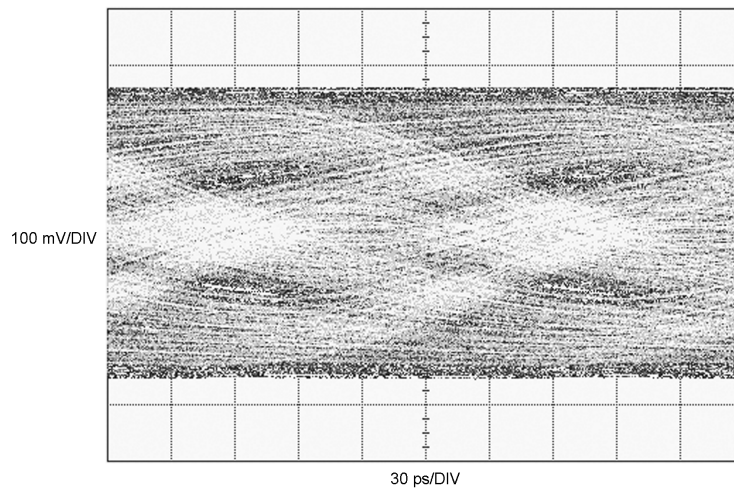
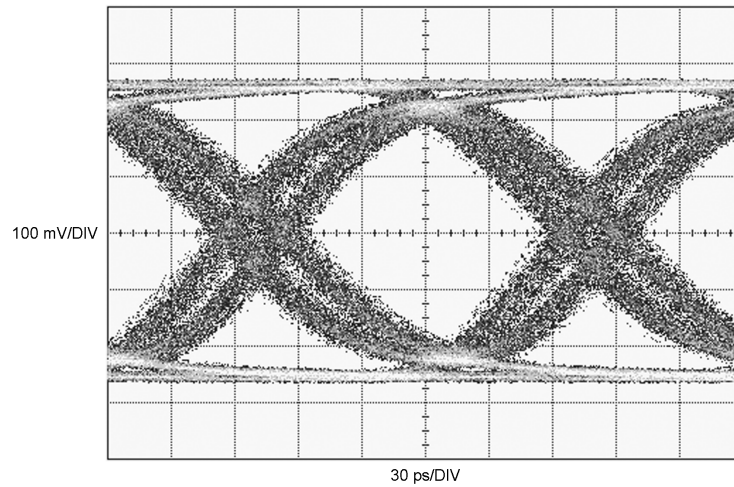

Figure 9. Typical 6.25Gb/s Equalizer *Output* Signal, with Input as shown in [Figure 8](#)



PRODUCT PREVIEW

Typical Performance Characteristics (continued)

TYPICAL OPERATING CHARACTERISTICS

Typical performance are measured at $V_{DD} = 1.8V$, $T_A = 25^\circ C$, unless otherwise noted. They are measured with a FR4 stripline test channel and acquired by an oscilloscope with 2k sampling hits, which includes approximately 10ps of system jitter.

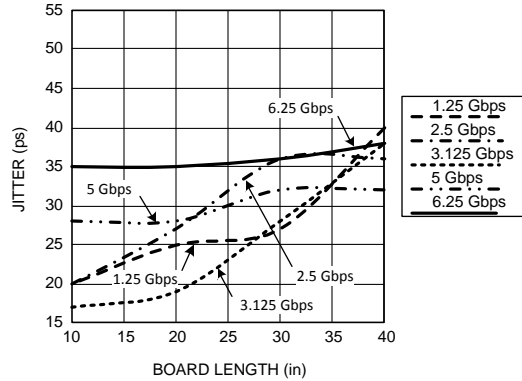

Figure 10. Total Jitter vs Board Length (FR4) (Input Level = $1V_{p-p}$, K28.5 Pattern)

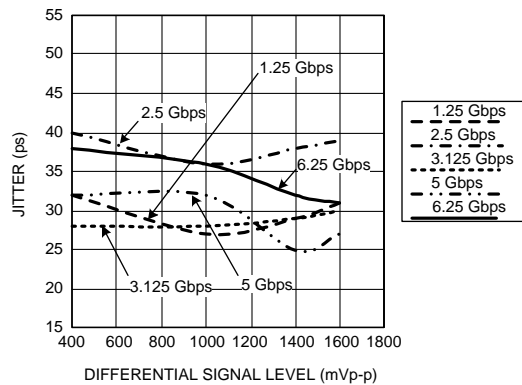

Figure 11. Total Jitter vs Signal Level (K28.5 Pattern, 30in FR4 Board)

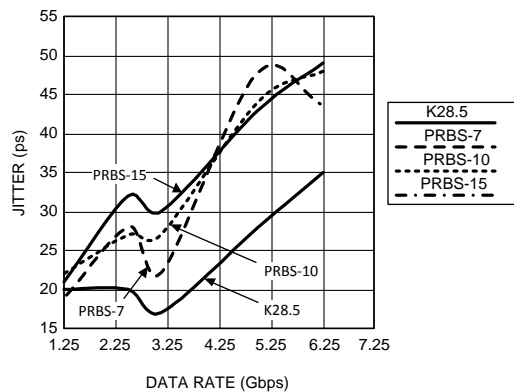

Figure 12. Total Jitter vs Data Rate For 10in of FR4 Board (Input Level = $1V_{p-p}$)

PRODUCT PREVIEW

Typical Performance Characteristics (continued)

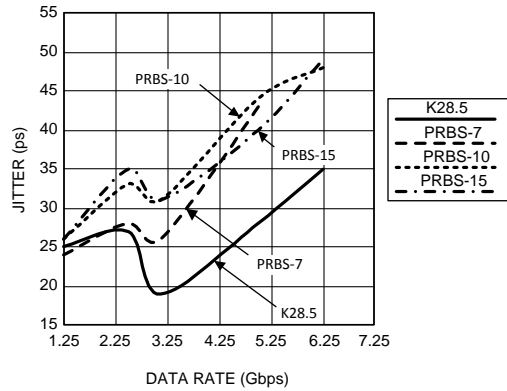

Figure 13. Total Jitter vs Data Rate For 20in of FR4 Board (Input Level = 1V_{P-P})

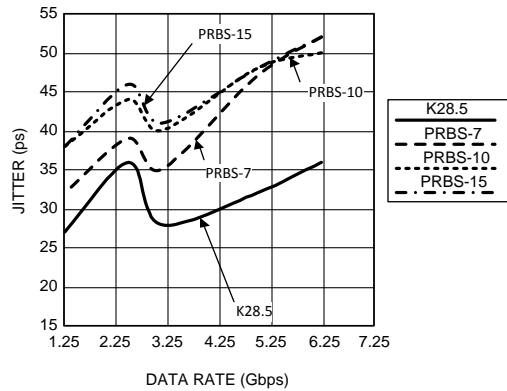

Figure 14. Total Jitter vs Data Rate For 30in of FR4 Board (Input Level = 1V_{P-P})

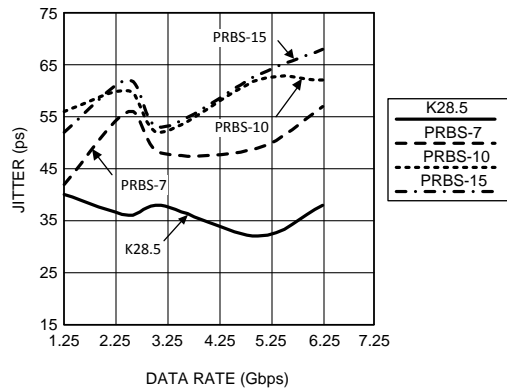

Figure 15. Total Jitter vs Data Rate For 40in of FR4 Board (Input Level = 1V_{P-P})

PRODUCT PREVIEW

Typical Performance Characteristics (continued)

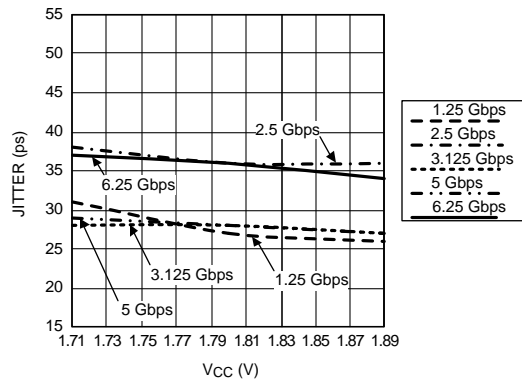

Figure 16. Total Jitter vs Vcc
(Input Level = 1V_{P-P}, K28.5 Pattern)

PRODUCT PREVIEW

PACKAGING INFORMATION

Orderable Device	Status (1)	Package Type	Package Drawing	Pins	Package Qty	Eco Plan (2)	Lead finish/ Ball material (6)	MSL Peak Temp (3)	Op Temp (°C)	Device Marking (4/5)	Samples
EQ50F100LR/NOPB	LIFEBUY	WSON	NGG	6	1000	RoHS & Green	SN	Level-1-260C-UNLIM	-40 to 85	EQ50F	

(1) The marketing status values are defined as follows:

ACTIVE: Product device recommended for new designs.

LIFEBUY: TI has announced that the device will be discontinued, and a lifetime-buy period is in effect.

NRND: Not recommended for new designs. Device is in production to support existing customers, but TI does not recommend using this part in a new design.

PREVIEW: Device has been announced but is not in production. Samples may or may not be available.

OBSELETE: TI has discontinued the production of the device.

(2) **RoHS:** TI defines "RoHS" to mean semiconductor products that are compliant with the current EU RoHS requirements for all 10 RoHS substances, including the requirement that RoHS substance do not exceed 0.1% by weight in homogeneous materials. Where designed to be soldered at high temperatures, "RoHS" products are suitable for use in specified lead-free processes. TI may reference these types of products as "Pb-Free".

RoHS Exempt: TI defines "RoHS Exempt" to mean products that contain lead but are compliant with EU RoHS pursuant to a specific EU RoHS exemption.

Green: TI defines "Green" to mean the content of Chlorine (Cl) and Bromine (Br) based flame retardants meet JS709B low halogen requirements of <=1000ppm threshold. Antimony trioxide based flame retardants must also meet the <=1000ppm threshold requirement.

(3) MSL, Peak Temp. - The Moisture Sensitivity Level rating according to the JEDEC industry standard classifications, and peak solder temperature.

(4) There may be additional marking, which relates to the logo, the lot trace code information, or the environmental category on the device.

(5) Multiple Device Markings will be inside parentheses. Only one Device Marking contained in parentheses and separated by a "-" will appear on a device. If a line is indented then it is a continuation of the previous line and the two combined represent the entire Device Marking for that device.

(6) Lead finish/Ball material - Orderable Devices may have multiple material finish options. Finish options are separated by a vertical ruled line. Lead finish/Ball material values may wrap to two lines if the finish value exceeds the maximum column width.

Important Information and Disclaimer:The information provided on this page represents TI's knowledge and belief as of the date that it is provided. TI bases its knowledge and belief on information provided by third parties, and makes no representation or warranty as to the accuracy of such information. Efforts are underway to better integrate information from third parties. TI has taken and continues to take reasonable steps to provide representative and accurate information but may not have conducted destructive testing or chemical analysis on incoming materials and chemicals. TI and TI suppliers consider certain information to be proprietary, and thus CAS numbers and other limited information may not be available for release.

In no event shall TI's liability arising out of such information exceed the total purchase price of the TI part(s) at issue in this document sold by TI to Customer on an annual basis.

TAPE AND REEL INFORMATION

QUADRANT ASSIGNMENTS FOR PIN 1 ORIENTATION IN TAPE

*All dimensions are nominal

Device	Package Type	Package Drawing	Pins	SPQ	Reel Diameter (mm)	Reel Width W1 (mm)	A0 (mm)	B0 (mm)	K0 (mm)	P1 (mm)	W (mm)	Pin1 Quadrant
EQ50F100LR/NOPB	WSO	NGG	6	1000	178.0	12.4	3.3	3.3	1.0	8.0	12.0	Q1

TAPE AND REEL BOX DIMENSIONS



*All dimensions are nominal

Device	Package Type	Package Drawing	Pins	SPQ	Length (mm)	Width (mm)	Height (mm)
EQ50F100LR/NOPB	WSON	NGG	6	1000	210.0	185.0	35.0

NGG0006A

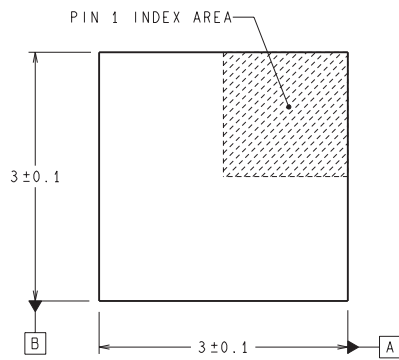

RECOMMENDED LAND PATTERN



DIMENSIONS ARE IN MILLIMETERS
DIMENSION IN () FOR REFERENCE ONLY

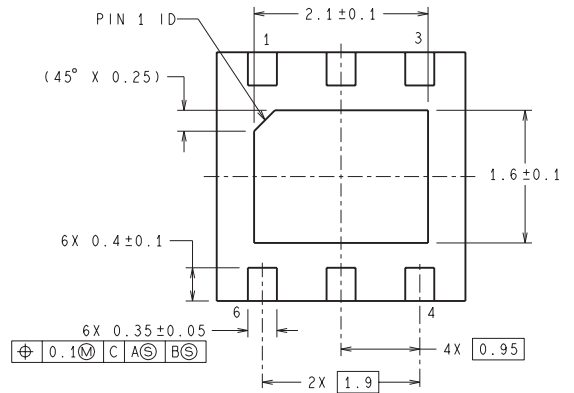
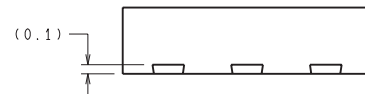

SDE06A (Rev A)

IMPORTANT NOTICE AND DISCLAIMER

TI PROVIDES TECHNICAL AND RELIABILITY DATA (INCLUDING DATA SHEETS), DESIGN RESOURCES (INCLUDING REFERENCE DESIGNS), APPLICATION OR OTHER DESIGN ADVICE, WEB TOOLS, SAFETY INFORMATION, AND OTHER RESOURCES "AS IS" AND WITH ALL FAULTS, AND DISCLAIMS ALL WARRANTIES, EXPRESS AND IMPLIED, INCLUDING WITHOUT LIMITATION ANY IMPLIED WARRANTIES OF MERCHANTABILITY, FITNESS FOR A PARTICULAR PURPOSE OR NON-INFRINGEMENT OF THIRD PARTY INTELLECTUAL PROPERTY RIGHTS.

These resources are intended for skilled developers designing with TI products. You are solely responsible for (1) selecting the appropriate TI products for your application, (2) designing, validating and testing your application, and (3) ensuring your application meets applicable standards, and any other safety, security, regulatory or other requirements.

These resources are subject to change without notice. TI grants you permission to use these resources only for development of an application that uses the TI products described in the resource. Other reproduction and display of these resources is prohibited. No license is granted to any other TI intellectual property right or to any third party intellectual property right. TI disclaims responsibility for, and you will fully indemnify TI and its representatives against, any claims, damages, costs, losses, and liabilities arising out of your use of these resources.

TI's products are provided subject to [TI's Terms of Sale](#) or other applicable terms available either on [ti.com](https://www.ti.com) or provided in conjunction with such TI products. TI's provision of these resources does not expand or otherwise alter TI's applicable warranties or warranty disclaimers for TI products.

TI objects to and rejects any additional or different terms you may have proposed.

Mailing Address: Texas Instruments, Post Office Box 655303, Dallas, Texas 75265
Copyright © 2024, Texas Instruments Incorporated