

LM95071-Q1 SPI/MICROWIRE 13-Bit Plus Sign Temperature Sensor

1 Features

- AEC-Q100 Qualified for Automotive Applications
 - Device Temperature Grade 0: -40°C to $+150^{\circ}\text{C}$, T_A
- Small SOT-23 Package Saves Space
- Shutdown Mode Conserves Power Between Temperature Readings
- Operates Over a Full -40°C to $+150^{\circ}\text{C}$ Range
- SPI and MICROWIRE Bus Interface
- Key Specifications
 - Supply Voltage: 2.4 V to 5.5 V
 - Supply Current
 - Operating: 280 μA (Typical)
 - Shutdown: 6 μA (Typical)
 - Temperature Accuracy
 - 0°C to 70°C $\pm 1^{\circ}\text{C}$ (Maximum)
 - -40°C to 150°C $\pm 2^{\circ}\text{C}$ (Maximum)
 - Temperature Resolution 0.03125 $^{\circ}\text{C}$

2 Applications

- Automotive
- System Thermal Management
- Portable Electronic Devices
- Personal Computers
- Disk Drives
- Office Electronics
- Electronic Test Equipment

3 Description

The LM95071-Q1 is a low-power, high-resolution digital temperature sensor with an SPI and MICROWIRE compatible interface, available in the 5-pin SOT-23. The host can query the LM95071-Q1 at any time to read temperature. Its low operating current is useful in systems where low power consumption is critical.

The LM95071-Q1 has 13-bit plus sign temperature resolution (0.03125 $^{\circ}\text{C}$ per LSB) while operating over a temperature range of -40°C to $+150^{\circ}\text{C}$.

The 2.4-V to 5.5-V supply voltage range, fast conversion rate, low supply current, and simple SPI interface of the LM95071-Q1 make it ideal for a wide range of applications.

Device Information⁽¹⁾

PART NUMBER	PACKAGE	BODY SIZE (NOM)
LM95071-Q1	SOT-23 (5)	2.90 mm x 1.60 mm

(1) For all available packages, see the orderable addendum at the end of the data sheet.

Temperature Monitor Application

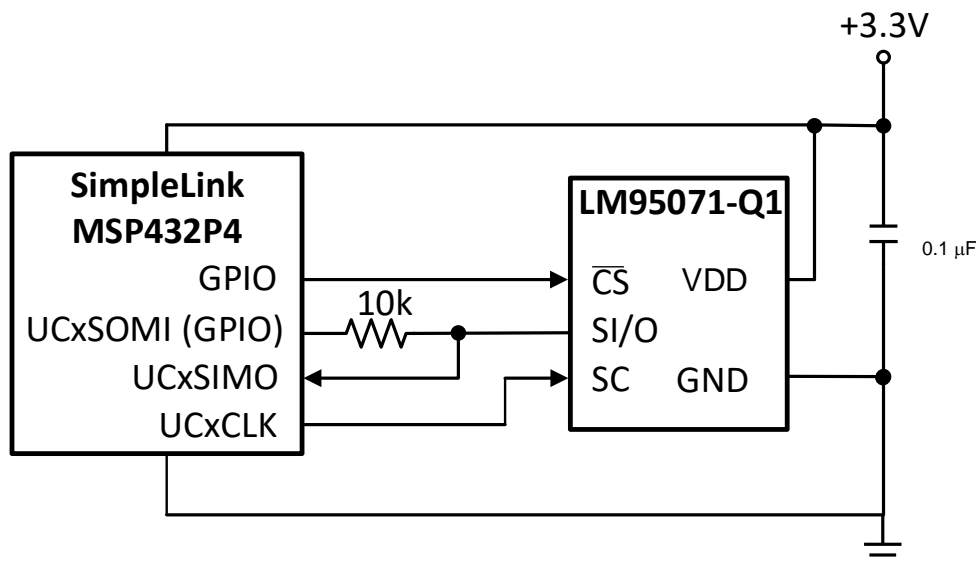

Table of Contents

1 Features 1 2 Applications 1 3 Description 1 4 Revision History 2 5 Pin Configuration and Functions 3 6 Specifications 3 6.1 Absolute Maximum Ratings 3 6.2 ESD Ratings..... 3 6.3 Recommended Operating Ratings..... 4 6.4 Thermal Information 4 6.5 Temperature-to-Digital Converter Characteristics..... 4 6.6 Logic Electrical Characteristics - Digital DC Characteristics 4 6.7 Logic Electrical Characteristics - Serial Bus Digital Switching Characteristics 5 6.8 Timing Diagrams 5 6.9 Typical Characteristics 7	7 Parameter Measurement Information 8 8 Detailed Description 9 8.1 Overview 9 8.2 Functional Block Diagram 9 8.3 Feature Description..... 9 8.4 Device Functional Modes..... 10 8.5 Programming 10 8.6 Register Maps 12 9 Device and Documentation Support 14 9.1 Receiving Notification of Documentation Updates.. 14 9.2 Community Resource..... 14 9.3 Trademarks 14 9.4 Electrostatic Discharge Caution..... 14 9.5 Glossary 14 10 Mechanical, Packaging, and Orderable Information 14
--	--

4 Revision History

NOTE: Page numbers for previous revisions may differ from page numbers in the current version.

DATE	VERSION	NOTES
December 2018	*	Initial release. Moved the automotive device from the SNIS137 to a standalone data sheet, added AEC-Q100 qualification levels to the data sheet, updated data sheet layout to the latest SDS format, changed the key graphics on the first page, changed Temperature-to-Digital Converter Characteristics tablenote to clarify conversion interval, and Replaced the <i>Thermal Characteristics</i> table with the <i>Thermal Information</i> table and updated the thermal resistance values

5 Pin Configuration and Functions

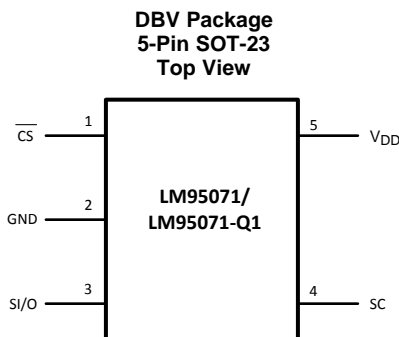

Pin Function

PIN		DESCRIPTION
NO.	NAME	
1	\overline{CS}	Chip Select input. This pin receives an active-low signal from the controller to select the device.
2	GND	Ground. This is the power and signal ground return.
3	SI/O	Serial Input/Output. This serial, bidirectional, data bus pin transmits and receives signals to and from the controller. Schmitt trigger input in the input mode.
4	SC	Serial bus clock. This serial clock signal comes from the controller. Schmitt trigger input.
5	V_{DD}	Positive Supply Voltage. Supply a DC voltage from 2.4V to 5.5V to this pin and bypass with a 0.1- μ F ceramic capacitor to ground.

6 Specifications

6.1 Absolute Maximum Ratings ⁽¹⁾⁽²⁾⁽³⁾

	MIN	MAX	UNIT
Supply voltage	-0.3	6	V
Voltage at any pin	-0.3	$V_{DD} + 0.3$	V
Input current at any pin ⁽⁴⁾		5	mA
Storage temperature, T_{stg}	-65	150	$^{\circ}$ C

- (1) Absolute Maximum Ratings indicate limits beyond which damage to the device may occur. DC and AC electrical specifications do not apply when operating the device beyond its rated operating conditions.
- (2) Soldering process must comply with Reflow Temperature Profile specifications. Refer to <http://www.ti.com/packaging>.
- (3) Reflow temperature profiles are different for lead-free and non-lead-free packages.
- (4) When the input voltage (V_I) at any pin exceeds the power supplies ($V_I < GND$ or $V_I > V_{DD}$) the current at that pin should be limited to 5 mA.

6.2 ESD Ratings

		VALUE	UNIT
$V_{(ESD)}$	Electrostatic discharge	Human-body model (HBM), per AEC Q100-002 ⁽¹⁾ HBM ESD Classification Level 2	± 2000
		Charged-device model (CDM), per AEC Q100-011 CDM ESD Classification Level C2	± 200

- (1) AEC Q100-002 indicates that HBM stressing shall be in accordance with the ANSI/ESDA/JEDEC JS-001 specification.

6.3 Recommended Operating Ratings

	MIN	MAX	UNIT
Specified temperature ⁽¹⁾ , T _{MIN} to T _{MAX}	-40	150	°C
Supply voltage (V _{DD})	2.4	5.5	V

- (1) The life expectancy of the of the LM95071-Q1 will be reduced when operating at elevated temperatures. of the LM95071-Q1 θ_{JA} (thermal resistance, junction-to-ambient) when attached to a printed-circuit board with 2-oz. foil is summarized in the table below.

6.4 Thermal Information

THERMAL METRIC ⁽¹⁾		LM95071-Q1	UNIT
		DBV (SOT-23)	
		5 PINS	
R _{θJA}	Junction-to-ambient thermal resistance	167.2	°C/W
R _{θJC(top)}	Junction-to-case (top) thermal resistance	118.8	°C/W
R _{θJB}	Junction-to-board thermal resistance	30.7	°C/W
ψ _{JT}	Junction-to-top characterization parameter	14.4	°C/W
ψ _{JB}	Junction-to-board characterization parameter	30.1	°C/W
R _{θJC(bot)}	Junction-to-case (bottom) thermal resistance	n/a	°C/W

- (1) For more information about traditional and new thermal metrics, see the [Semiconductor and IC Package Thermal Metrics](#) application report.

6.5 Temperature-to-Digital Converter Characteristics

Unless otherwise noted, these specifications apply for V_{DD} = 3.3 V. All limits T_A = T_J = +25°C, unless otherwise noted.

PARAMETER	TEST CONDITIONS		MIN ⁽¹⁾	TYP ⁽²⁾	MAX ⁽¹⁾	UNIT
Temperature error ⁽³⁾	V _{DD} = 3.0V to 3.6V; T _A = 0°C to +70°C, T _A = T _J = T _{MIN} to T _{MAX}				±1.0	°C
	V _{DD} = 3.0V to 3.6V; T _A = -40°C to +150°C, T _A = T _J = T _{MIN} to T _{MAX}				±2.0	°C
Line regulation	V _{DD} = 3.6V to 5.5V; T _A = 0°C to +70°C				+0.3	°C/V
	V _{DD} = 3.0V to 2.4V; T _A = 0°C to +70°C				-0.6	
Resolution				14 0.03125		Bits °C
Temperature conversion time	See ⁽⁴⁾	T _A = T _J = +25°C		130		ms
		T _A = T _J = T _{MIN} to T _{MAX}			228	
Quiescent current	Operating, serial bus inactive	T _A = T _J = +25°C		280		µA
		T _A = T _J = T _{MIN} to T _{MAX}			520	
	Shutdown	T _A = T _J = +25°C		6		µA
		T _A = T _J = T _{MIN} to T _{MAX}			28	

- (1) Limits are guaranteed to TI's AOQL (Average Outgoing Quality Level).
 (2) Typicals are at T_A = 25°C and represent most likely parametric norm.
 (3) The of the LM95071-Q1 will operate properly over the V_{DD} supply voltage range of 2.4V to 5.5V.
 (4) Following a power on reset, the user must allow at least 228 ms before making the first read transaction to ensure a first valid temperature read. After the first read, in order to ensure an accurate temperature result, the time interval between any two consecutive temperature reads must be greater than the maximum conversion time of 228 ms.

6.6 Logic Electrical Characteristics - Digital DC Characteristics

Unless otherwise noted, these specifications apply for V_{DD} = 2.4 V to 5.5 V⁽¹⁾.

PARAMETER	TEST CONDITIONS	MIN ⁽²⁾	TYP ⁽³⁾	MAX ⁽²⁾	UNIT
V _{IN(1)} Logical "1" Input Voltage	T _A = T _J = T _{MIN} to T _{MAX}	0.7 × V _{DD}		V _{DD} + 0.3	V
V _{IN(0)} Logical "0" Input Voltage	T _A = T _J = T _{MIN} to T _{MAX}	-0.3		0.3 × V _{DD}	V

- (1) The of the LM95071-Q1 will operate properly over the V_{DD} supply voltage range of 2.4V to 5.5V.
 (2) Limits are guaranteed to TI's AOQL (Average Outgoing Quality Level).
 (3) Typicals are at T_A = 25°C and represent most likely parametric norm.

Logic Electrical Characteristics - Digital DC Characteristics (continued)

Unless otherwise noted, these specifications apply for $V_{DD} = 2.4\text{ V to }5.5\text{ V}^{(1)}$.

PARAMETER	TEST CONDITIONS		MIN ⁽²⁾	TYP ⁽³⁾	MAX ⁽²⁾	UNIT
Input Hysteresis Voltage	$V_{DD} = 3\text{ V to }3.6\text{ V}$	$T_A = T_J = +25^\circ\text{C}$	0.4		V	
		$T_A = T_J = T_{MIN}\text{ to }T_{MAX}$	0.33			
$I_{IN(1)}$ Logical "1" Input Current	$V_{IN} = V_{DD}$	$T_A = T_J = +25^\circ\text{C}$	0.005		μA	
		$T_A = T_J = T_{MIN}\text{ to }T_{MAX}$	3			
$I_{IN(0)}$ Logical "0" Input Current	$V_{IN} = 0\text{ V}$	$T_A = T_J = +25^\circ\text{C}$	-0.005		μA	
		$T_A = T_J = T_{MIN}\text{ to }T_{MAX}$	-3			
C_{IN} All Digital Inputs	$T_A = T_J = +25^\circ\text{C}$		20		pF	
V_{OH} High Level Output Voltage	$I_{OH} = -400\ \mu\text{A}, T_A = T_J = T_{MIN}\text{ to }T_{MAX}$		2.25		V	
V_{OL} Low Level Output Voltage	$I_{OL} = +1.6\ \text{mA}, T_A = T_J = T_{MIN}\text{ to }T_{MAX}$		0.4		V	
$I_{O_TRI-STATE}$ TRI-STATE Output Leakage Current	$V_O = \text{GND}$ $V_O = V_{DD}, T_A = T_J = T_{MIN}\text{ to }T_{MAX}$		-1		+1	μA

6.7 Logic Electrical Characteristics - Serial Bus Digital Switching Characteristics

Unless otherwise noted, these specifications apply for $V_{DD} = 2.4\text{ V to }5.5\text{ V}^{(1)}$; C_L (load capacitance) on output lines = 100 pF unless otherwise specified.

		MIN ⁽²⁾	TYP ⁽³⁾	MAX ⁽²⁾	UNIT
t_1 SC (Clock) Period		$T_A = T_J = T_{MIN}\text{ to }T_{MAX}$		0.16	μs
		$T_A = T_J = +25^\circ\text{C}$		DC	
t_2 $\overline{\text{CS}}$ Low to SC (Clock) High Set-Up Time		$T_A = T_J = T_{MIN}\text{ to }T_{MAX}$		100	ns
t_3 $\overline{\text{CS}}$ Low to Data Out (SO) Delay		$T_A = T_J = T_{MIN}\text{ to }T_{MAX}$		70	ns
t_4 SC (Clock) Low to Data Out (SO) Delay		$T_A = T_J = T_{MIN}\text{ to }T_{MAX}$		70	ns
t_5 $\overline{\text{CS}}$ High to Data Out (SO) TRI-STATE		$T_A = T_J = T_{MIN}\text{ to }T_{MAX}$		200	ns
t_6 SC (Clock) High to Data In (SI) Hold Time		$T_A = T_J = T_{MIN}\text{ to }T_{MAX}$		50	ns
t_7 Data In (SI) Set-Up Time to SC (Clock) High		$T_A = T_J = T_{MIN}\text{ to }T_{MAX}$		30	ns
t_8 SC (Clock) High to $\overline{\text{CS}}$ High Hold Time		$T_A = T_J = T_{MIN}\text{ to }T_{MAX}$		50	ns

- (1) The of the LM95071-Q1 will operate properly over the V_{DD} supply voltage range of 2.4V to 5.5V.
- (2) Limits are guaranteed to TI's AOQL (Average Outgoing Quality Level).
- (3) Typicals are at $T_A = 25^\circ\text{C}$ and represent most likely parametric norm.

6.8 Timing Diagrams

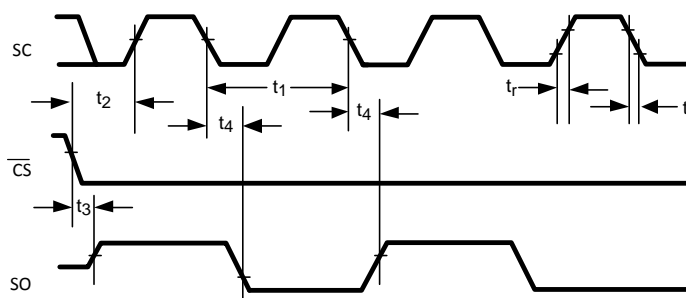
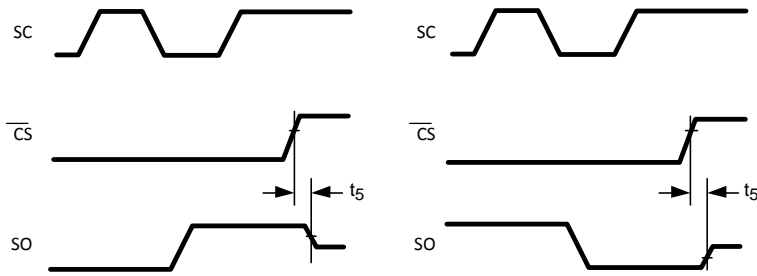
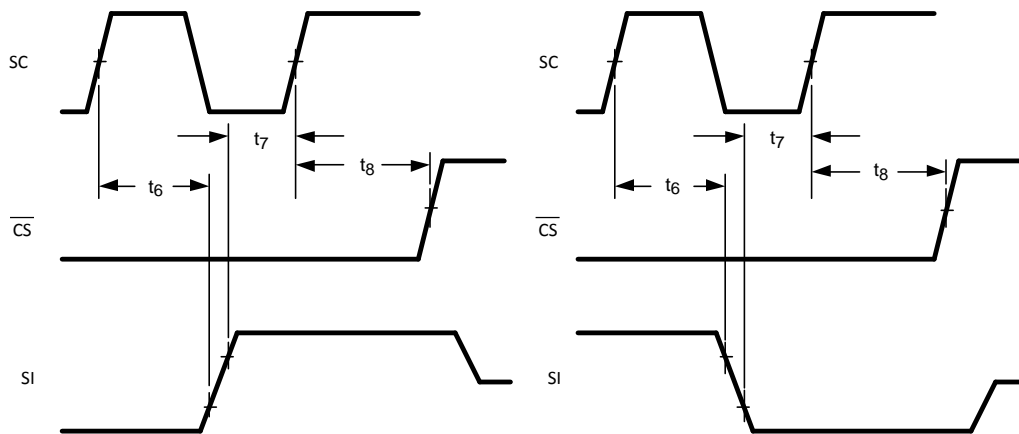

Figure 1. Data Output Timing Diagram

Timing Diagrams (continued)

Figure 2. TRI-STATE Data Output Timing Diagram

Figure 3. Data Input Timing Diagram

6.9 Typical Characteristics

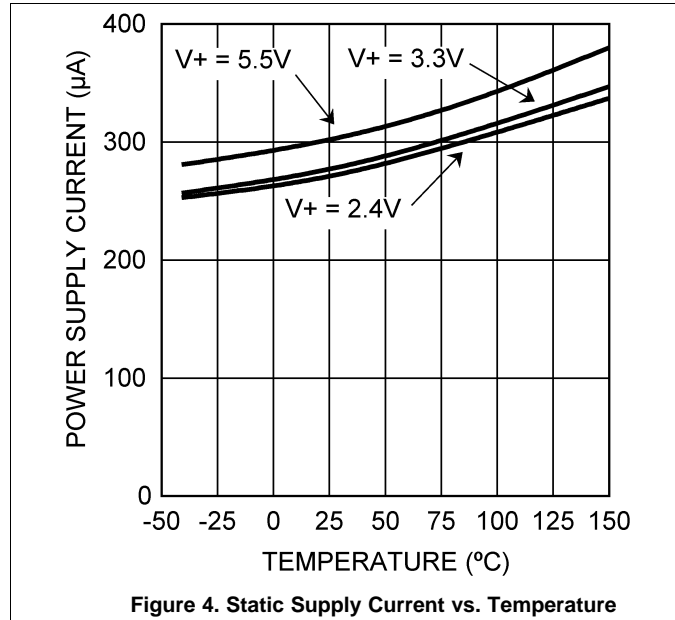

Figure 4. Static Supply Current vs. Temperature

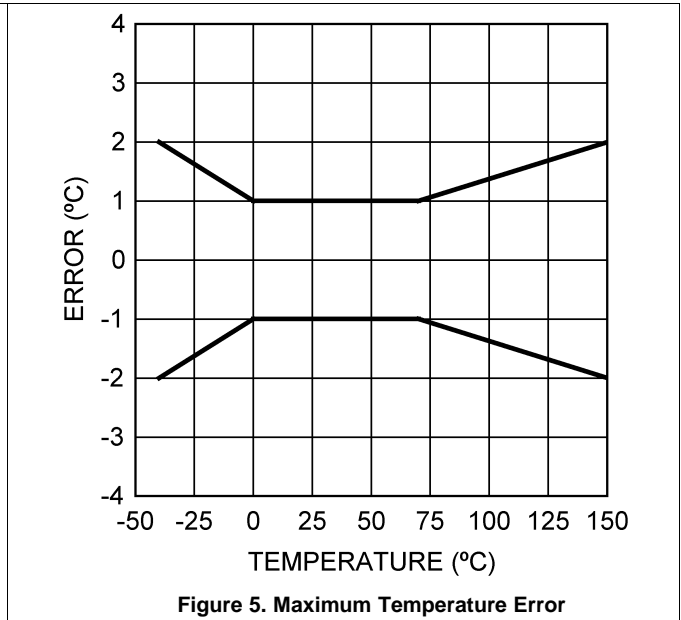

Figure 5. Maximum Temperature Error

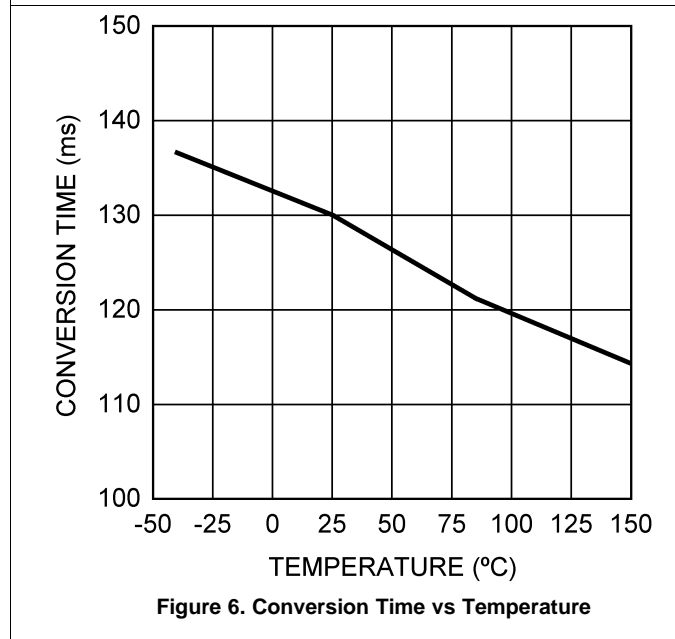

Figure 6. Conversion Time vs Temperature

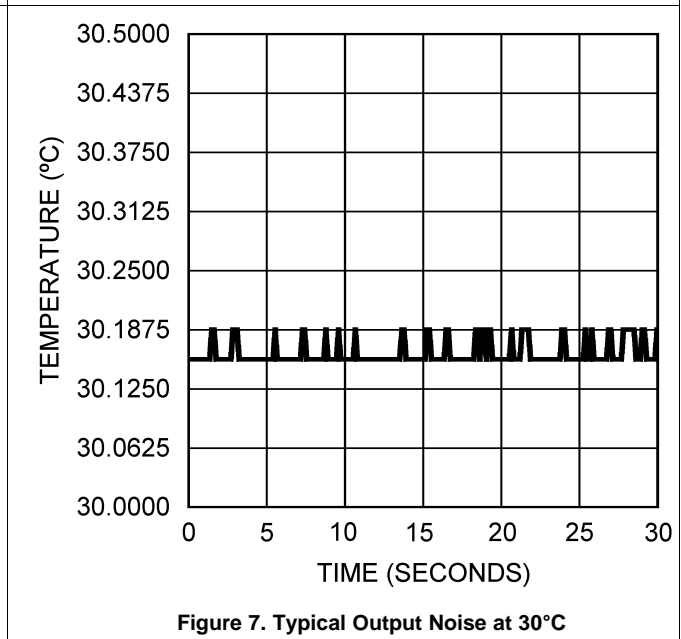

Figure 7. Typical Output Noise at 30°C

7 Parameter Measurement Information

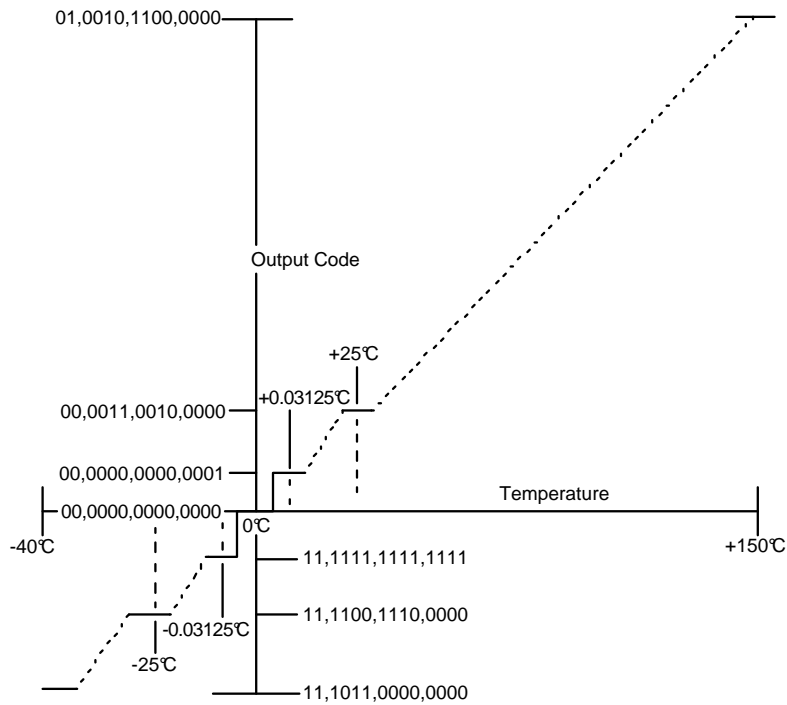

Figure 8. Temperature-to-Digital Transfer Function (Non-Linear Scale for Clarity)

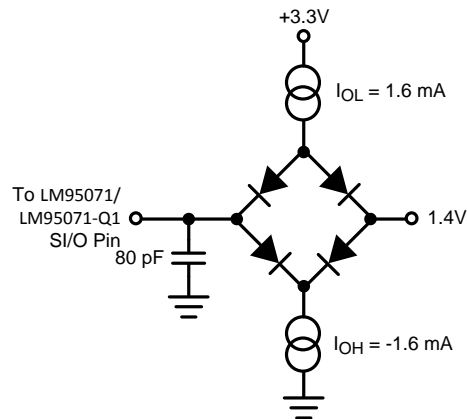

Figure 9. TRI-STATE Test Circuit

8 Detailed Description

8.1 Overview

The LM95071-Q1 temperature sensor incorporates a temperature sensor and 13-bit-plus-sign $\Delta\Sigma$ ADC (Delta-Sigma Analog-to-Digital Converter). Compatibility of the LM95071-Q1's three-wire serial interface with SPI and MICROWIRE allows simple communications with common microcontrollers and processors. Shutdown mode can be used to optimize current drain for different applications. A Manufacturer/Device ID register identifies the LM95071-Q1 as a Texas Instruments product.

8.2 Functional Block Diagram

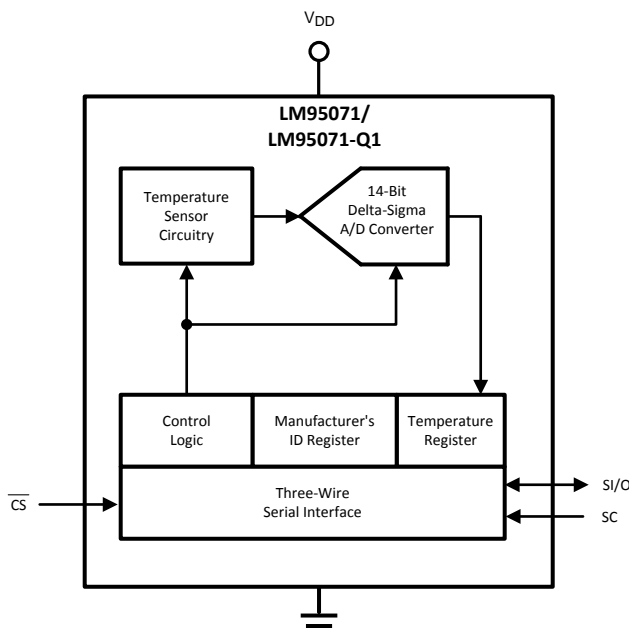

8.3 Feature Description

8.3.1 Power Up and Power Down

The LM95071-Q1 always powers up in a known state and in the continuous conversion mode. Immediately after power up, the LM95071-Q1 will output an erroneous code until the first temperature conversion has completed.

When the supply voltage is less than about 1.6V (typical), the LM95071-Q1 is considered powered down. As the supply voltage rises above the nominal 1.6-V power up threshold, the internal registers are reset to the power up default state described above.

8.3.2 Temperature Data Format

Temperature data is represented by a 14-bit, two's complement word with an LSB (Least Significant Bit) equal to 0.03125°C:

Table 1. Digital Output for Temperature Data

Temperature	Digital Output	
	Binary	Hex
+150°C	0100 1011 0000 0011	4B03
+125°C	0011 1110 1000 0011	3E83
+25°C	0000 1100 1000 0011	0C83
+0.03125°C	0000 0000 0000 0111	0007
0°C	0000 0000 0000 0011	0003

Table 1. Digital Output for Temperature Data (continued)

Temperature	Digital Output	
	Binary	Hex
-0.03125°C	1111 1111 1111 1111	FFFF
-25°C	1111 0011 1000 0011	F383
-40°C	1110 1100 0000 0011	EC03

The first data byte is the most significant byte with most significant bit first, permitting only as much data as necessary to be read to determine temperature condition. For instance, if the first four bits of the temperature data indicate an overtemperature condition, the host processor could immediately take action to remedy the excessive temperatures.

8.3.3 Tight Accuracy, Fine Resolution and Low Noise

The LM95071-Q1 is well suited for applications that require tight temperature measurement accuracy. In many applications, from process control to HVAC, the low temperature error can mean better system performance and, by eliminating a system calibration step, lower production cost.

With fine digital resolution, the LM95071-Q1 senses and reports very small changes in its temperature, making it ideal for applications where temperature sensitivity is important. For example, the LM95071-Q1 enables the system to quickly identify the direction of temperature change, allowing the processor to take compensating action before the system reaches a critical temperature.

The LM95071-Q1 has very low output noise (see [Figure 7](#) in the [Typical Characteristics](#) section), which makes it ideal for applications where stable thermal compensation is a priority. For example, in a temperature-compensated oscillator application, the very small deviation in successive temperature readings translates to a stable frequency output from the oscillator.

8.4 Device Functional Modes

8.4.1 Shutdown Mode/Manufacturer ID

The master controller may enable the shutdown mode for the purpose of reducing power consumption or for reading the Manufacturer/Device ID information. The shutdown mode is enabled by writing XX FF hex to the LM95071-Q1 as shown in [Figure 13c](#). The serial bus is still active when the LM95071-Q1 is in shutdown. When in shutdown mode the LM95071-Q1 always will output 1000 0000 0000 1111. This is the Manufacturer/Device ID information. The first 5-bits of the field (1000 0XXX) are reserved for the manufacturer ID.

8.5 Programming

8.5.1 Serial Bus Interface

The LM95071-Q1 operates as a slave and is compatible with SPI or MICROWIRE bus specifications. Data is clocked out on the falling edge of the serial clock (SC), while data is clocked in on the rising edge of SC. A complete communication is framed by falling and rising chip select (CS) signal. The CS signal should be held high for at least one clock cycle (160 ns minimum) between communications. The transmit-only communication (register read) consists of 16 clock cycles. A complete transmit/receive communication will consist of 32 serial clocks (see [Serial Bus Timing Diagrams](#)). The first 16 clocks comprise the transmit phase of communication, while the second 16 clocks are the receive phase.

When \overline{CS} is high SI/O will be in TRI-STATE. Communication should be initiated by taking chip select (\overline{CS}) low. This should not be done when SC is changing from a low to high state. Once \overline{CS} is low the serial I/O pin (SI/O) will transmit the first bit of data. The master can then read this bit with the rising edge of SC. The remainder of the data will be clocked out by the falling edge of SC. \overline{CS} can be taken high at any time during the transmit phase. If \overline{CS} is brought low in the middle of a conversion the LM95071-Q1 will complete the conversion and the output shift register will be updated after \overline{CS} is brought back high.

Programming (continued)

The receive phase of a communication starts after 16 SC periods. \overline{CS} can remain low for 32 SC cycles. The LM95071/LM95071-Q1 will read the data available on the SI/O line on the rising edge of the serial clock. Input data is to an 8-bit shift register. The part will detect the last eight bits shifted into the register. The receive phase can last up to 16 SC periods. All ones must be shifted in order to place the part into shutdown. All zeros must be shifted in order to place the LM95071-Q1 into continuous conversion mode. Only the following codes should be transmitted to the LM95071-Q1:

- 00 hex for continuous conversion
- FF hex for shutdown

Another code may place the part into a test mode. Test modes are used by Texas Instruments to thoroughly test the function of the LM95071-Q1 during production testing. Only eight bits have been defined above since only the last eight transmitted are detected by the LM95071-Q1, before \overline{CS} is taken HIGH.

The following communication can be used to determine the Manufacturer's/Device ID and then immediately place the part into continuous conversion mode. With \overline{CS} continuously low:

- Read 16 bits of temperature data
- Write 16 bits of data commanding shutdown
- Read 16 bits of Manufacturer's/Device ID data
- Write 8 to 16 bits of data commanding Conversion Mode
- Take \overline{CS} HIGH.

Note that 228 ms (max) will have to pass for a conversion to complete before the LM95071-Q1 actually transmits temperature data.

8.5.2 Serial Bus Timing Diagrams

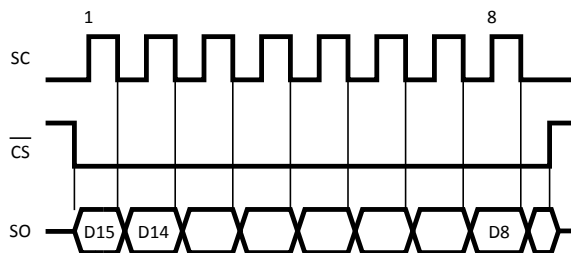

Figure 10. Reading Continuous Conversion - Single Eight-Bit Frame

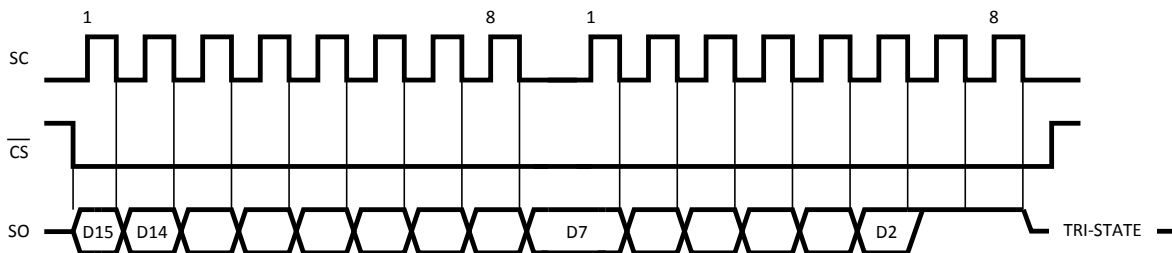

Figure 11. Reading Continuous Conversion - Two Eight-Bit Frames

Programming (continued)

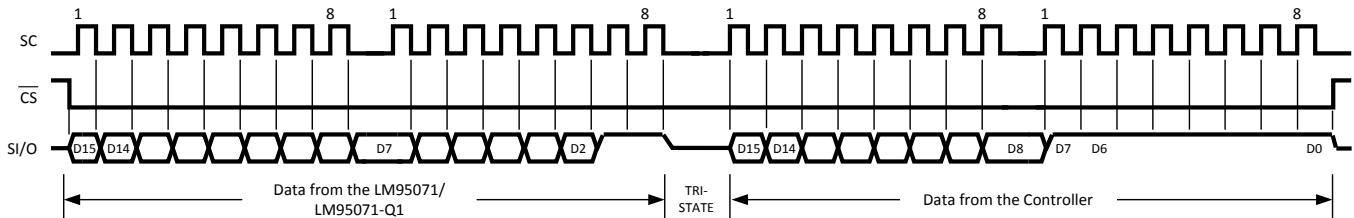

Figure 12. Writing Shutdown Mode

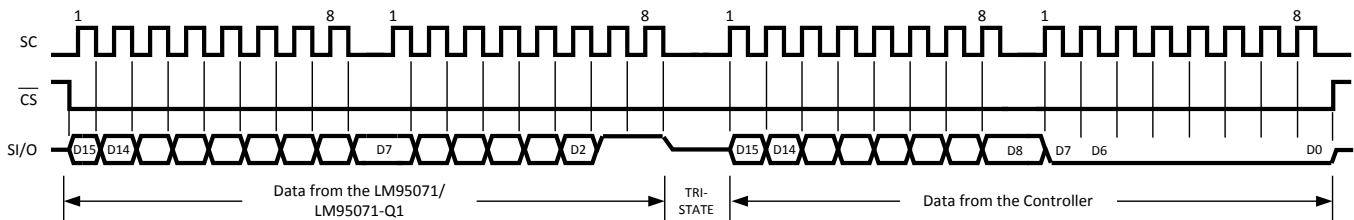

Figure 13. Writing Conversion Mode

8.6 Register Maps

8.6.1 Internal Register Structure

The LM95071-Q1 has three registers: the temperature register, the configuration register and the Manufacturer/Device identification register. The temperature and Manufacturer/Device identification registers are read only. The configuration register is write only.

8.6.1.1 Configuration Register

(Selects shutdown or continuous conversion modes):

Table 2. (Write Only):

D15	D14	D13	D12	D11	D10	D9	D8	D7	D6	D5	D4	D3	D2	D1	D0
X	X	X	X	X	X	X	X								

Shutdown

D0–D15 set to XX FF hex enables shutdown mode.

D0–D15 set to XX 00 hex sets continuous-conversion mode.

Note: setting D0-D15 to any other values may place the LM95071-Q1 into a manufacturer's test mode, upon which the LM95071-Q1 will stop responding as described. These test modes are to be used for Texas Instruments production testing only. See [Serial Bus Interface](#) for a complete discussion.

8.6.1.2 Temperature Register

Table 3. (Read Only):

D15	D14	D13	D12	D11	D10	D9	D8	D7	D6	D5	D4	D3	D2	D1	D0
MSB	Bit 12	Bit 11	Bit 10	Bit 9	Bit 8	Bit 7	Bit 6	Bit 5	Bit 4	Bit 3	Bit 2	Bit 1	LSB	1	1

D0–D1: Logic 1 will be output on SI/0.

D2–D15: Temperature Data. One LSB = 0.03125°C. Two's complement format.

8.6.1.3 Manufacturer/Device ID Register

Table 4. (Read Only):

D15	D14	D13	D12	D11	D10	D9	D8	D7	D6	D5	D4	D3	D2	D1	D0
1	0	0	0	0	0	0	0	0	0	0	0	1	1	1	1

D0–D1: Logic 1 will be output on SI/0.

D2–D15: Manufacturer/Device ID Data. This register is accessed whenever the LM95071-Q1 is in shutdown mode.

9 Device and Documentation Support

9.1 Receiving Notification of Documentation Updates

To receive notification of documentation updates, navigate to the device product folder on ti.com. In the upper right corner, click on *Alert me* to register and receive a weekly digest of any product information that has changed. For change details, review the revision history included in any revised document.

9.2 Community Resource

The following links connect to TI community resources. Linked contents are provided "AS IS" by the respective contributors. They do not constitute TI specifications and do not necessarily reflect TI's views; see TI's [Terms of Use](#).

TI E2E™ Online Community *TI's Engineer-to-Engineer (E2E) Community*. Created to foster collaboration among engineers. At e2e.ti.com, you can ask questions, share knowledge, explore ideas and help solve problems with fellow engineers.

Design Support *TI's Design Support* Quickly find helpful E2E forums along with design support tools and contact information for technical support.

9.3 Trademarks

E2E is a trademark of Texas Instruments.

TRI-STATE is a registered trademark of National Semiconductor Corporation.

All other trademarks are the property of their respective owners.

9.4 Electrostatic Discharge Caution



These devices have limited built-in ESD protection. The leads should be shorted together or the device placed in conductive foam during storage or handling to prevent electrostatic damage to the MOS gates.

9.5 Glossary

[SLYZ022](#) — *TI Glossary*.

This glossary lists and explains terms, acronyms, and definitions.

10 Mechanical, Packaging, and Orderable Information

The following pages include mechanical, packaging, and orderable information. This information is the most current data available for the designated devices. This data is subject to change without notice and revision of this document. For browser-based versions of this data sheet, refer to the left-hand navigation.

PACKAGING INFORMATION

Orderable Device	Status (1)	Package Type	Package Drawing	Pins	Package Qty	Eco Plan (2)	Lead finish/ Ball material (6)	MSL Peak Temp (3)	Op Temp (°C)	Device Marking (4/5)	Samples
LM95071QIMF/NOPB	OBSOLETE	SOT-23	DBV	5		TBD	Call TI	Call TI	-40 to 150	T18Q	
LM95071QIMFX/NOPB	ACTIVE	SOT-23	DBV	5	3000	RoHS & Green	SN	Level-1-260C-UNLIM	-40 to 150	T18Q	Samples

(1) The marketing status values are defined as follows:

ACTIVE: Product device recommended for new designs.

LIFEBUY: TI has announced that the device will be discontinued, and a lifetime-buy period is in effect.

NRND: Not recommended for new designs. Device is in production to support existing customers, but TI does not recommend using this part in a new design.

PREVIEW: Device has been announced but is not in production. Samples may or may not be available.

OBSOLETE: TI has discontinued the production of the device.

(2) **RoHS:** TI defines "RoHS" to mean semiconductor products that are compliant with the current EU RoHS requirements for all 10 RoHS substances, including the requirement that RoHS substance do not exceed 0.1% by weight in homogeneous materials. Where designed to be soldered at high temperatures, "RoHS" products are suitable for use in specified lead-free processes. TI may reference these types of products as "Pb-Free".

RoHS Exempt: TI defines "RoHS Exempt" to mean products that contain lead but are compliant with EU RoHS pursuant to a specific EU RoHS exemption.

Green: TI defines "Green" to mean the content of Chlorine (Cl) and Bromine (Br) based flame retardants meet JS709B low halogen requirements of <=1000ppm threshold. Antimony trioxide based flame retardants must also meet the <=1000ppm threshold requirement.

(3) MSL, Peak Temp. - The Moisture Sensitivity Level rating according to the JEDEC industry standard classifications, and peak solder temperature.

(4) There may be additional marking, which relates to the logo, the lot trace code information, or the environmental category on the device.

(5) Multiple Device Markings will be inside parentheses. Only one Device Marking contained in parentheses and separated by a "~" will appear on a device. If a line is indented then it is a continuation of the previous line and the two combined represent the entire Device Marking for that device.

(6) Lead finish/Ball material - Orderable Devices may have multiple material finish options. Finish options are separated by a vertical ruled line. Lead finish/Ball material values may wrap to two lines if the finish value exceeds the maximum column width.

Important Information and Disclaimer:The information provided on this page represents TI's knowledge and belief as of the date that it is provided. TI bases its knowledge and belief on information provided by third parties, and makes no representation or warranty as to the accuracy of such information. Efforts are underway to better integrate information from third parties. TI has taken and continues to take reasonable steps to provide representative and accurate information but may not have conducted destructive testing or chemical analysis on incoming materials and chemicals. TI and TI suppliers consider certain information to be proprietary, and thus CAS numbers and other limited information may not be available for release.

In no event shall TI's liability arising out of such information exceed the total purchase price of the TI part(s) at issue in this document sold by TI to Customer on an annual basis.

OTHER QUALIFIED VERSIONS OF LM95071-Q1 :

- Catalog : [LM95071](#)

NOTE: Qualified Version Definitions:

- Catalog - TI's standard catalog product

TAPE AND REEL INFORMATION

QUADRANT ASSIGNMENTS FOR PIN 1 ORIENTATION IN TAPE

*All dimensions are nominal

Device	Package Type	Package Drawing	Pins	SPQ	Reel Diameter (mm)	Reel Width W1 (mm)	A0 (mm)	B0 (mm)	K0 (mm)	P1 (mm)	W (mm)	Pin1 Quadrant
LM95071QIMFX/NOPB	SOT-23	DBV	5	3000	178.0	8.4	3.2	3.2	1.4	4.0	8.0	Q3

TAPE AND REEL BOX DIMENSIONS

*All dimensions are nominal

Device	Package Type	Package Drawing	Pins	SPQ	Length (mm)	Width (mm)	Height (mm)
LM95071QIMFX/NOPB	SOT-23	DBV	5	3000	208.0	191.0	35.0

EXAMPLE BOARD LAYOUT

DBV0005A

SOT-23 - 1.45 mm max height

SMALL OUTLINE TRANSISTOR



LAND PATTERN EXAMPLE
EXPOSED METAL SHOWN
SCALE:15X



SOLDER MASK DETAILS

4214839/K 08/2024

NOTES: (continued)

- 6. Publication IPC-7351 may have alternate designs.
- 7. Solder mask tolerances between and around signal pads can vary based on board fabrication site.

EXAMPLE STENCIL DESIGN

DBV0005A

SOT-23 - 1.45 mm max height

SMALL OUTLINE TRANSISTOR



SOLDER PASTE EXAMPLE
BASED ON 0.125 mm THICK STENCIL
SCALE:15X

4214839/K 08/2024

NOTES: (continued)

8. Laser cutting apertures with trapezoidal walls and rounded corners may offer better paste release. IPC-7525 may have alternate design recommendations.
9. Board assembly site may have different recommendations for stencil design.

IMPORTANT NOTICE AND DISCLAIMER

TI PROVIDES TECHNICAL AND RELIABILITY DATA (INCLUDING DATA SHEETS), DESIGN RESOURCES (INCLUDING REFERENCE DESIGNS), APPLICATION OR OTHER DESIGN ADVICE, WEB TOOLS, SAFETY INFORMATION, AND OTHER RESOURCES "AS IS" AND WITH ALL FAULTS, AND DISCLAIMS ALL WARRANTIES, EXPRESS AND IMPLIED, INCLUDING WITHOUT LIMITATION ANY IMPLIED WARRANTIES OF MERCHANTABILITY, FITNESS FOR A PARTICULAR PURPOSE OR NON-INFRINGEMENT OF THIRD PARTY INTELLECTUAL PROPERTY RIGHTS.

These resources are intended for skilled developers designing with TI products. You are solely responsible for (1) selecting the appropriate TI products for your application, (2) designing, validating and testing your application, and (3) ensuring your application meets applicable standards, and any other safety, security, regulatory or other requirements.

These resources are subject to change without notice. TI grants you permission to use these resources only for development of an application that uses the TI products described in the resource. Other reproduction and display of these resources is prohibited. No license is granted to any other TI intellectual property right or to any third party intellectual property right. TI disclaims responsibility for, and you will fully indemnify TI and its representatives against, any claims, damages, costs, losses, and liabilities arising out of your use of these resources.

TI's products are provided subject to [TI's Terms of Sale](#) or other applicable terms available either on [ti.com](https://www.ti.com) or provided in conjunction with such TI products. TI's provision of these resources does not expand or otherwise alter TI's applicable warranties or warranty disclaimers for TI products.

TI objects to and rejects any additional or different terms you may have proposed.

Mailing Address: Texas Instruments, Post Office Box 655303, Dallas, Texas 75265
Copyright © 2024, Texas Instruments Incorporated