

# LMZ12010 10-A SIMPLE SWITCHER® Power Module With 20-V Maximum Input Voltage

## 1 Features

- Integrated shielded inductor
- Simple PCB layout
- Fixed switching frequency (350 kHz)
- Flexible start-up sequencing using external soft start, tracking, and precision enable
- Protection against inrush currents and faults such as input UVLO and output short circuit
- Junction temperature range:  $-40^{\circ}\text{C}$  to  $125^{\circ}\text{C}$
- Single exposed pad and standard pinout for easy mounting and manufacturing
- Fully enabled for WEBENCH® power designer
- Pin compatible with [LMZ22010](#), [LMZ22008](#), [LMZ22006](#), [LMZ12008](#), [LMZ12006](#), [LMZ23610](#), [LMZ23608](#), [LMZ23606](#), [LMZ13610](#), [LMZ13608](#), and [LMZ13606](#)
- Electrical specifications
  - 50-W maximum total output power
  - Up to 10-A output current
  - Input voltage range: 6 V to 20 V
  - Output voltage range: 0.8 V to 6 V
  - Efficiency up to 92%
- Performance benefits
  - High efficiency reduces system heat generation
  - Low radiated emissions (EMI) tested to EN55022 <sup>1</sup>
  - Only seven external components
  - Low output voltage ripple
  - No external heat sink required

## 2 Applications

- Point-of-load conversions from 12-V input rail
- Time-critical projects
- Space-constrained and high thermal requirement applications
- Negative output voltage applications (See AN-2027 [SNVA425](#))

## 3 Description

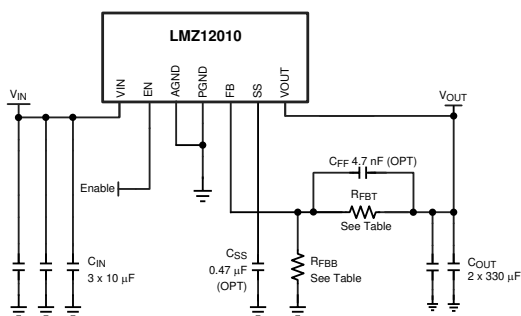
The LMZ12010 SIMPLE SWITCHER® power module is an easy-to-use step-down DC-DC solution capable of driving up to 10-A load. The LMZ12010 is available in an innovative package that enhances thermal performance and allows for hand or machine soldering.

The LMZ12010 device can accept an input voltage rail between 6 V and 20 V and deliver an adjustable and highly accurate output voltage as low as 0.8 V. The LMZ12010 only requires two external resistors and external capacitors to complete the power solution. The LMZ12010 is a reliable and robust design with the following protection features: thermal shutdown, programmable input undervoltage lockout, output overvoltage protection, short circuit protection, output current limit, and the device allows start-up into a prebiased output.

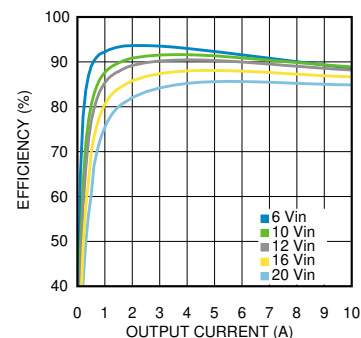
### Device Information

PART NUMBER <sup>(2)</sup>	PACKAGE <sup>(1)</sup>	BODY SIZE (NOM)
LMZ12010	NDY (11)	15.00 mm × 15.00 mm

- (1) For all available packages, see the orderable addendum at the end of the data sheet.
- (2) Peak reflow temperature equals  $245^{\circ}\text{C}$ . See [SNAA214](#) for more details.



**Simplified Application Schematic**



**Efficiency 3.3-V Output at  $25^{\circ}\text{C}$**

<sup>1</sup> EN 55022:2006, +A1:2007, FCC Part 15 Subpart B, tested on Evaluation Board with EMI configuration.



## Table of Contents

<b>1 Features</b> .....	1	8.1 Application Information.....	17
<b>2 Applications</b> .....	1	8.2 Typical Application.....	17
<b>3 Description</b> .....	1	<b>9 Power Supply Recommendations</b> .....	23
<b>4 Revision History</b> .....	2	<b>10 Layout</b> .....	24
<b>5 Pin Configuration and Functions</b> .....	3	10.1 Layout Guidelines.....	24
<b>6 Specifications</b> .....	4	10.2 Layout Examples.....	24
6.1 Absolute Maximum Ratings.....	4	10.3 Power Dissipation and Thermal Considerations.....	26
6.2 ESD Ratings.....	4	10.4 Power Module SMT Guidelines.....	27
6.3 Recommended Operating Conditions.....	4	<b>11 Device and Documentation Support</b> .....	29
6.4 Thermal Information.....	4	11.1 Device Support.....	29
6.5 Electrical Characteristics.....	5	11.2 Documentation Support.....	29
6.6 Typical Characteristics.....	6	11.3 Support Resources.....	29
<b>7 Detailed Description</b> .....	14	11.4 Receiving Notification of Documentation Updates..	29
7.1 Overview.....	14	11.5 Trademarks.....	29
7.2 Functional Block Diagram.....	14	11.6 Electrostatic Discharge Caution.....	29
7.3 Feature Description.....	14	11.7 Glossary.....	30
7.4 Device Functional Modes.....	15	<b>12 Mechanical, Packaging, and Orderable Information</b> .....	30
<b>8 Application and Implementation</b> .....	17		

## 4 Revision History

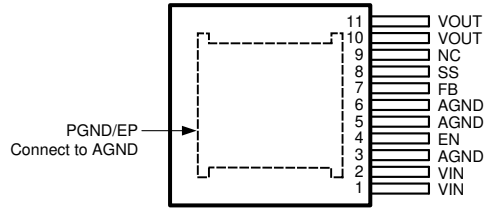
NOTE: Page numbers for previous revisions may differ from page numbers in the current version.

<b>Changes from Revision H (July 2015) to Revision I (March 2022)</b>	<b>Page</b>
• Updated the numbering format for tables, figures, and cross-references throughout the document. ....	1
• Corrected AGND pin 2 to AGND pin 3.....	3

---

<b>Changes from Revision G (October 2013) to Revision H (July 2015)</b>	<b>Page</b>
• Added <i>Pin Configuration and Functions</i> section, <i>ESD Ratings</i> table, <i>Feature Description</i> section, <i>Device Functional Modes</i> , <i>Application and Implementation</i> section, <i>Power Supply Recommendations</i> section, <i>Layout</i> section, <i>Device and Documentation Support</i> section, and <i>Mechanical, Packaging, and Orderable Information</i> section .....	1

## 5 Pin Configuration and Functions



**Figure 5-1. 11-Pin NDY Package (Top View)**

**Table 5-1. Pin Functions**

PIN		TYPE	DESCRIPTION
NAME	NO.		
AGND	3	Ground	Analog ground — Reference point for all stated voltages. Must be externally connected to PGND (EP).
	5		
	6		
EN	4	Analog	Enable — Input to the precision enable comparator. Rising threshold is 1.274 V (typical). Once the module is enabled, a 13- $\mu$ A source current is internally activated to facilitate programmable hysteresis.
FB	7	Analog	Feedback — Internally connected to the regulation amplifier and overvoltage comparator. The regulation reference point is 0.795 V at this input pin. Connect the feedback resistor divider between VOUT and AGND to set the output voltage.
NC	9	—	No connect — This pin must remain floating, do not ground.
PGND	—	Ground	Exposed pad/power ground — Electrical path for the power circuits within the module. PGND is not internally connected to AGND (pin 5, 6). Must be electrically connected to pins 5 and 6 external to the package. The exposed pad is also used to dissipate heat from the package during operation. Use 100 12-mil thermal vias from top to bottom copper for best thermal performance.
SS	8	Analog	Soft-start/track input — To extend the 1.6-ms internal soft start, connect an external soft-start capacitor. For tracking, connect to an external resistive divider to a higher priority supply rail. See <a href="#">Section 8.2.2</a> .
VIN	1	Power	Input supply — Nominal operating range is 6 V to 20 V. A small amount of internal capacitance is contained within the package assembly. Additional external input capacitance is required between this pin and the exposed pad (PGND).
	2		
VOUT	10	Power	Output voltage — Output from the internal inductor. Connect the output capacitor between this pin and exposed pad (PGND).
	11		

## 6 Specifications

### 6.1 Absolute Maximum Ratings

	MIN <sup>(1) (2)</sup>	MAX <sup>(1) (2)</sup>	UNIT
VIN to PGND	−0.3	24	V
EN to AGND	−0.3	5.5	V
SS, FB to AGND	−0.3	2.5	V
AGND to PGND	−0.3	0.3	V
Junction Temperature		150	°C
Peak reflow case temperature (30 sec)		245	°C
Storage temperature, T <sub>stg</sub>	−65	150	°C

- (1) Stresses beyond those listed under *Absolute Maximum Ratings* may cause permanent damage to the device. These are stress ratings only, which do not imply functional operation of the device at these or any other conditions beyond those indicated under *Recommended Operating Conditions*. Exposure to absolute-maximum-rated conditions for extended periods may affect device reliability.
- (2) For soldering specifications, refer to the [Absolute Maximum Ratings for Soldering](#) application report.

### 6.2 ESD Ratings

	VALUE	UNIT
V <sub>(ESD)</sub> Electrostatic discharge Human body model (HBM), per ANSI/ESDA/JEDEC JS-001 <sup>(1) (2)</sup>	±2000	V

- (1) JEDEC document JEP155 states that 500-V HBM allows safe manufacturing with a standard ESD control process.
- (2) The human body model is a 100-pF capacitor discharged through a 1.5-kΩ resistor into each pin. Test method is per JESD-22-114.

### 6.3 Recommended Operating Conditions

	MIN <sup>(1)</sup>	MAX <sup>(1)</sup>	UNIT
VIN	6	20	V
EN	0	5	V
Operation junction temperature	−40	125	°C

- (1) *Absolute Maximum Ratings* are limits beyond which damage to the device may occur. Operating Ratings are conditions under which operation of the device is intended to be functional. For compliant specifications and test conditions, see the *Electrical Characteristics*.

### 6.4 Thermal Information

THERMAL METRIC <sup>(1)</sup>		LMZ12010	UNIT	
		NDY		
		11 PINS		
R <sub>θJA</sub>	Junction-to-ambient thermal resistance	Natural Convection	9.9	°C/W
		225 LFPM	6.8	
		500 LFPM	5.2	
R <sub>θJC(top)</sub>	Junction-to-case (top) thermal resistance	1.0	°C/W	

- (1) For more information about traditional and new thermal metrics, see the *Semiconductor and IC Package Thermal Metrics* application report, [SPRA953](#).

## 6.5 Electrical Characteristics

Limits are for  $T_J = 25^\circ\text{C}$  unless otherwise specified. Minimum and Maximum limits are ensured through test, design or statistical correlation. Typical values represent the most likely parametric norm at  $T_J = 25^\circ\text{C}$ , and are provided for reference purposes only. Unless otherwise stated the following conditions apply:  $V_{IN} = 12\text{ V}$ ,  $V_{OUT} = 3.3\text{ V}$

PARAMETER		TEST CONDITIONS		MIN	TYP	MAX	UNIT
<b>SYSTEM PARAMETERS</b>							
<b>ENABLE CONTROL</b>							
$V_{EN}$	EN threshold	$V_{EN}$ rising			1.274		V
			Over the junction temperature ( $T_J$ ) range of $-40^\circ\text{C}$ to $+125^\circ\text{C}$	1.096		1.452	
$I_{EN-HYS}$	EN hysteresis source current	$V_{EN} > 1.274\text{ V}$			13		$\mu\text{A}$
<b>SOFT-START</b>							
$I_{SS}$	SS source current	$V_{SS} = 0\text{ V}$			50		$\mu\text{A}$
			Over the junction temperature ( $T_J$ ) range of $-40^\circ\text{C}$ to $+125^\circ\text{C}$	40		60	
$t_{SS}$	Internal soft-start interval				1.6		ms
<b>CURRENT LIMIT</b>							
$I_{CL}$	Current limit threshold	DC average			12.5		A
<b>INTERNAL SWITCHING OSCILLATOR</b>							
$f_{osc}$	Free-running oscillator frequency			314	359	404	kHz
<b>REGULATION AND OVERVOLTAGE COMPARATOR</b>							
$V_{FB}$	In-regulation feedback voltage	$V_{SS} >+ 0.8\text{ V}$ $I_O = 10\text{ A}$			0.795		V
			over the junction temperature ( $T_J$ ) range of $-40^\circ\text{C}$ to $+125^\circ\text{C}$	0.775		0.815	
$V_{FB-OV}$	Feedback overvoltage protection threshold				0.86		V
$I_{FB}$	Feedback input bias current				5		nA
$I_Q$	Nonswitching quiescent current				3		mA
$I_{SD}$	Shutdown quiescent current	$V_{EN} = 0\text{ V}$			32		$\mu\text{A}$
$D_{max}$	Maximum duty factor				85%		
<b>THERMAL CHARACTERISTICS</b>							
$T_{SD}$	Thermal shutdown	Rising			165		$^\circ\text{C}$
$T_{SD-HYST}$	Thermal shutdown hysteresis	Falling			15		$^\circ\text{C}$
<b>PERFORMANCE PARAMETERS <sup>(1)</sup></b>							
$\Delta V_O$	Output voltage ripple	BW at 20 MHz			24		mV <sub>PP</sub>
$\Delta V_O/\Delta V_{IN}$	Line regulation	$V_{IN} = 12\text{ V}$ to $20\text{ V}$ , $I_{OUT} = 10\text{ A}$			$\pm 0.2\%$		
$\Delta V_O/\Delta I_{OUT}$	Load regulation	$V_{IN} = 12\text{ V}$ , $I_{OUT} = 0.001\text{ A}$ to $10\text{ A}$			1		mV/A
$\eta$	Peak efficiency	$V_{IN} = 12\text{ V}$ , $V_{OUT} = 3.3\text{ V}$ , $I_{OUT} = 5\text{ A}$			89.5%		
$\eta$	Full load efficiency	$V_{IN} = 12\text{ V}$ , $V_{OUT} = 3.3\text{ V}$ , $I_{OUT} = 10\text{ A}$			87.5%		

(1) EN 55022:2006, +A1:2007, FCC Part 15 Subpart B, tested on Evaluation Board with EMI configuration.

## 6.6 Typical Characteristics

Unless otherwise specified, the following conditions apply:  $V_{IN} = 12\text{ V}$ ;  $C_{IN} = \text{three} \times 10\text{-}\mu\text{F} + 47\text{-nF X7R Ceramic}$ ;  $C_{OUT} = \text{two} \times 330\text{-}\mu\text{F Specialty Polymer} + 47\text{-}\mu\text{F Ceramic} + 47\text{-nF Ceramic}$ ;  $C_{FF} = 4.7\text{ nF}$ ;  $T_A = 25^\circ\text{C}$  for waveforms. All indicated temperatures are ambient.

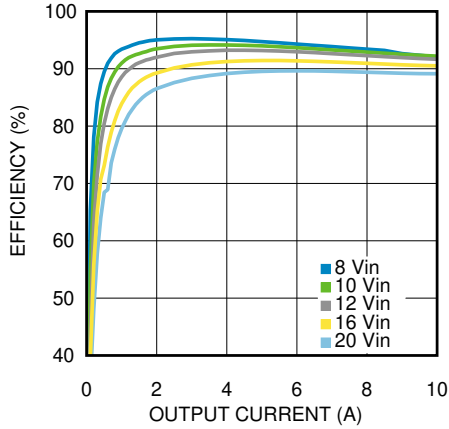


Figure 6-1. Efficiency 5-V Output at 25°C

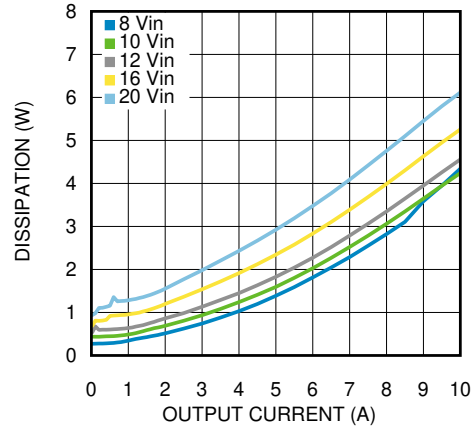


Figure 6-2. Dissipation 5-V Output at 25°C

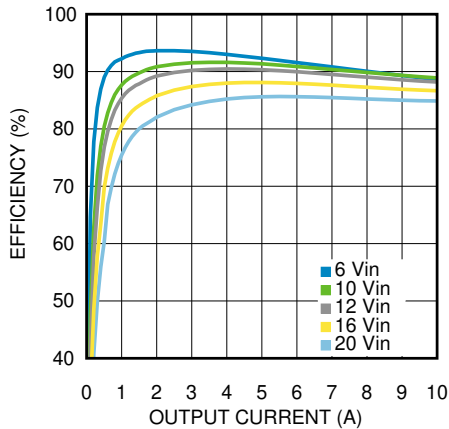


Figure 6-3. Efficiency 3.3-V Output at 25°C

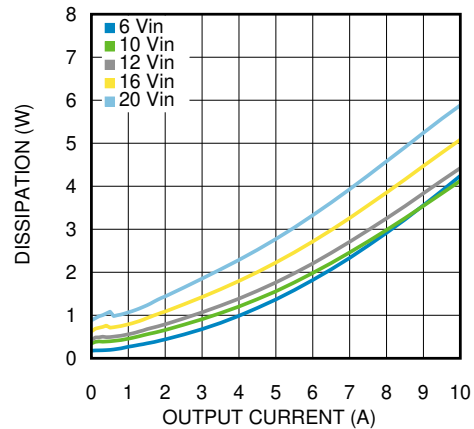


Figure 6-4. Dissipation 3.3-V Output at 25°C

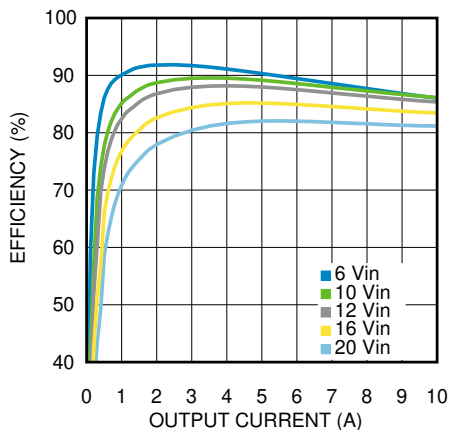


Figure 6-5. Efficiency 2.5-V Output at 25°C

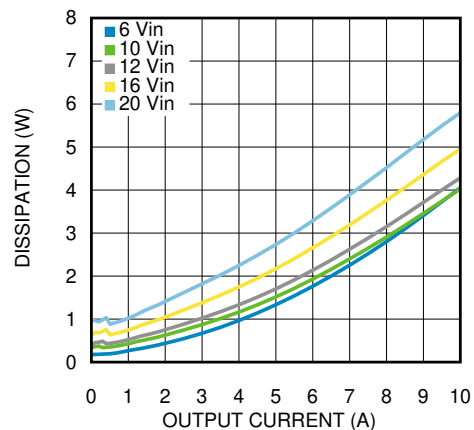
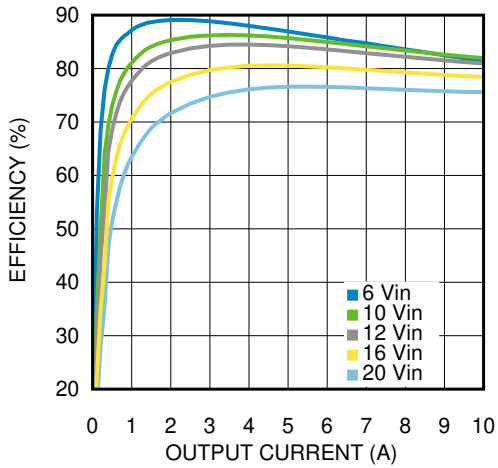
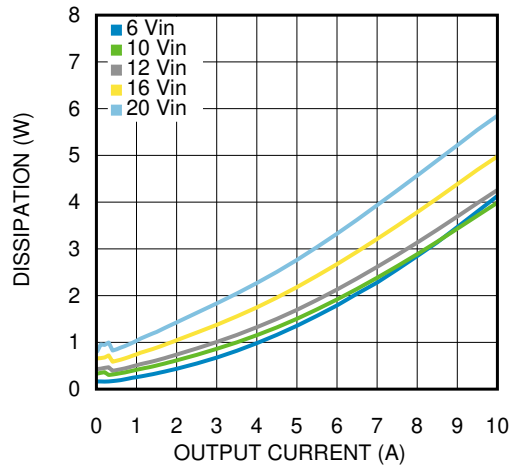


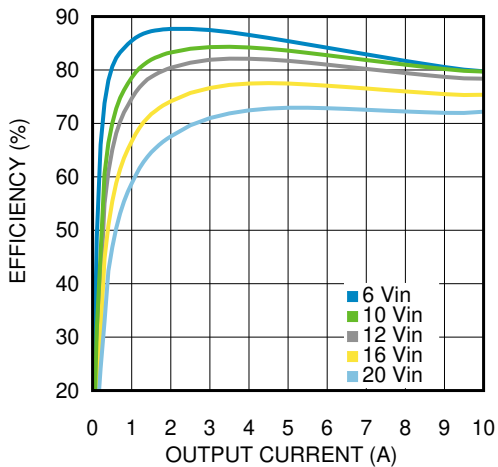
Figure 6-6. Dissipation 2.5-V Output at 25°C



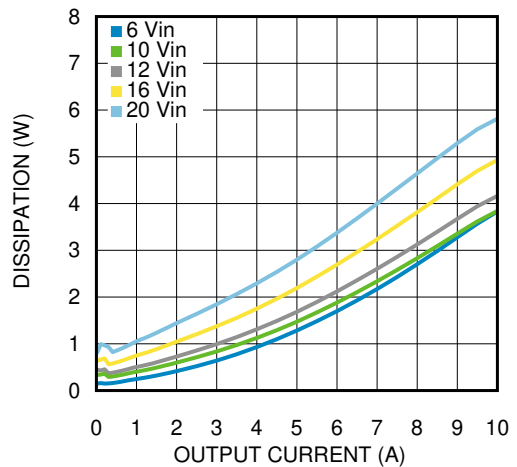
**Figure 6-7. Efficiency 1.8-V Output at 25°C**



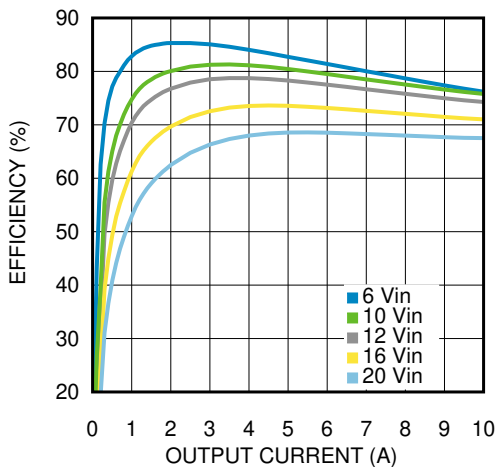
**Figure 6-8. Dissipation 1.8-V Output at 25°C**



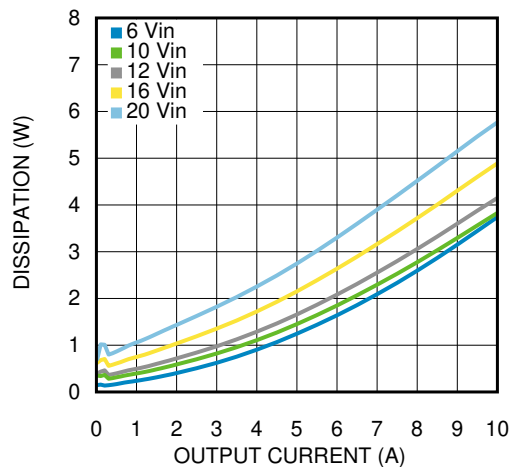
**Figure 6-9. Efficiency 1.5-V Output at 25°C**



**Figure 6-10. Dissipation 1.5-V Output at 25°C**



**Figure 6-11. Efficiency 1.2-V Output at 25°C**



**Figure 6-12. Dissipation 1.2-V Output at 25°C**

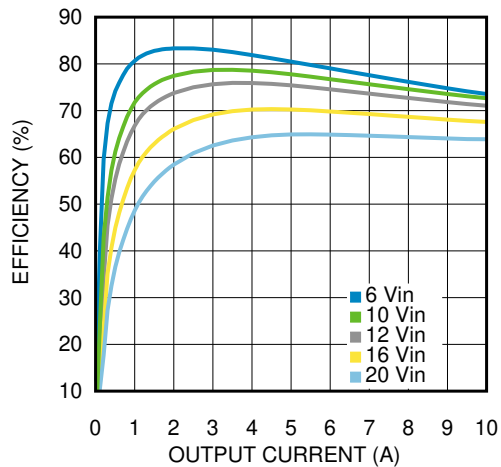


Figure 6-13. Efficiency 1-V Output at 25°C

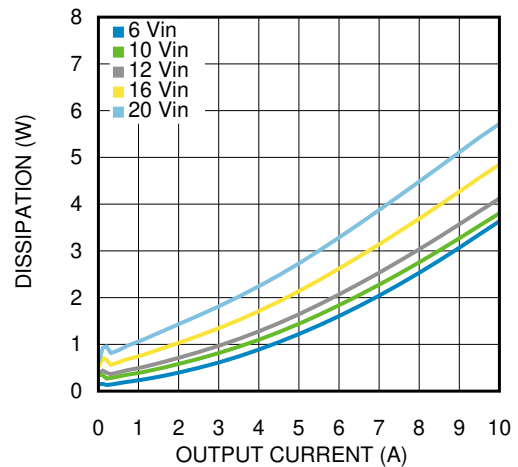


Figure 6-14. Dissipation 1-V Output at 25°C

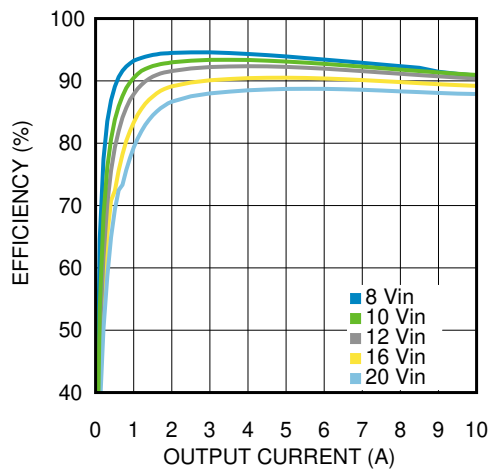


Figure 6-15. Efficiency 5-V Output at 85°C

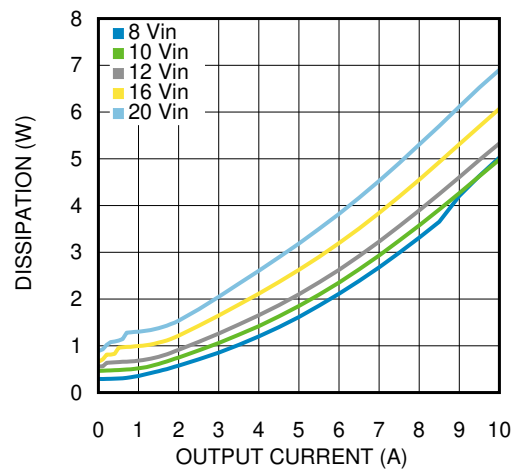


Figure 6-16. Dissipation 5-V Output at 85°C

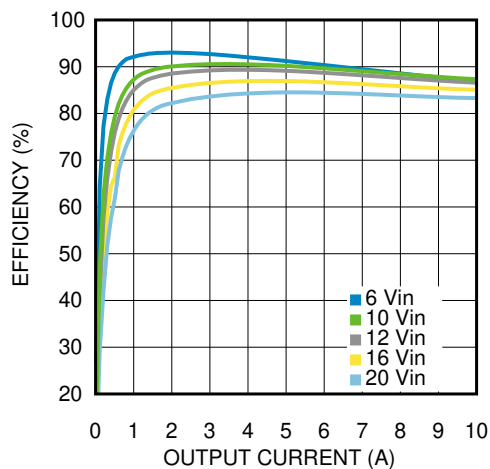


Figure 6-17. Efficiency 3.3-V Output at 85°C

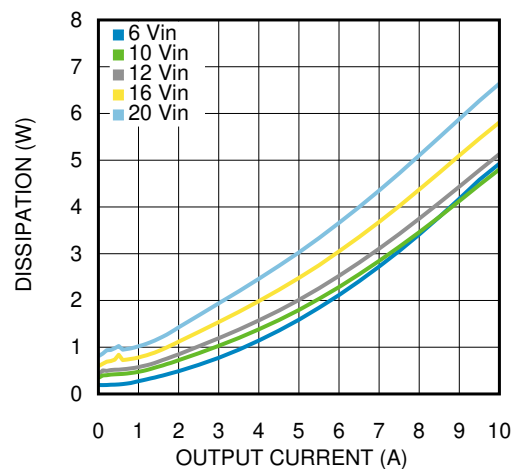
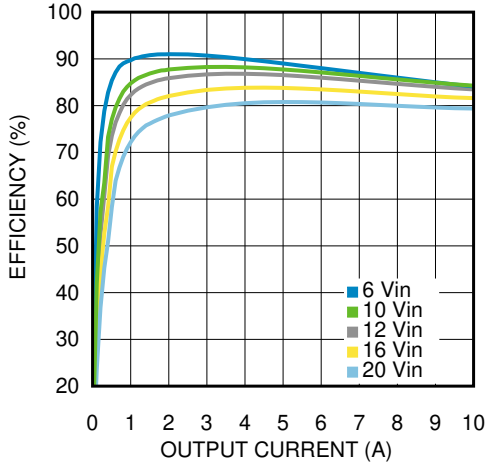
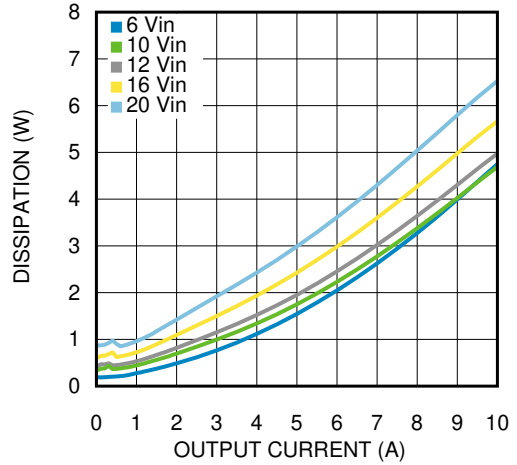


Figure 6-18. Dissipation 3.3-V Output at 85°C

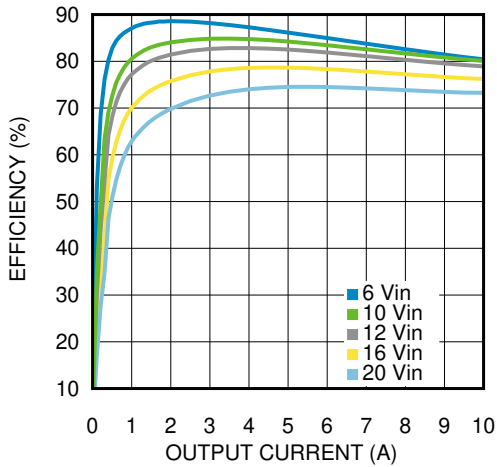




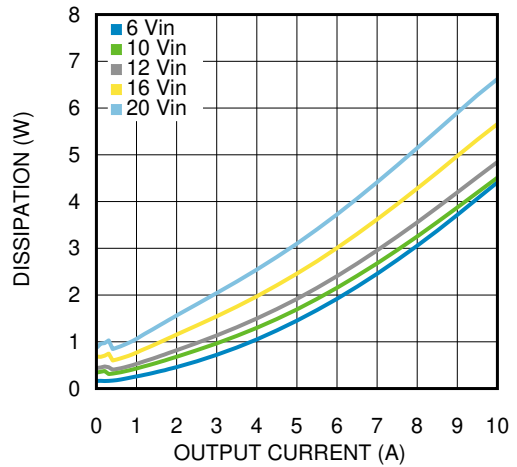
**Figure 6-19. Efficiency 2.5-V Output at 85°C**



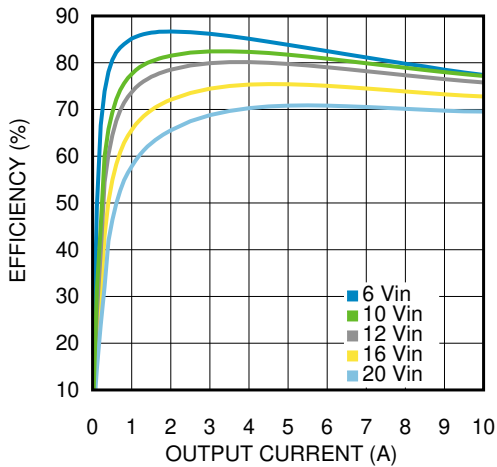
**Figure 6-20. Dissipation 2.5-V Output at 85°C**



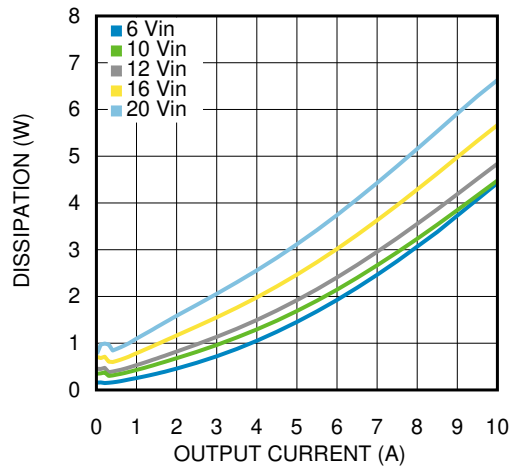
**Figure 6-21. Efficiency 1.8-V Output at 85°C**



**Figure 6-22. Dissipation 1.8-V Output at 85°C**



**Figure 6-23. Efficiency 1.5-V Output at 85°C**



**Figure 6-24. Dissipation 1.5-V Output at 85°C**

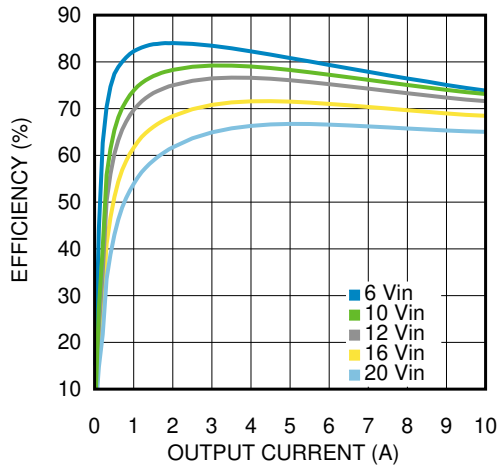


Figure 6-25. Efficiency 1.2-V Output at 85°C

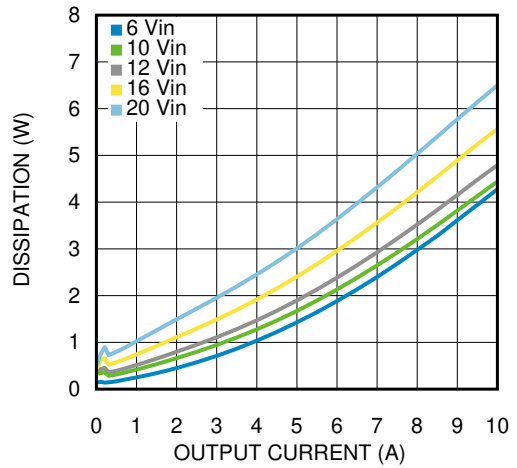


Figure 6-26. Dissipation 1.2-V Output at 85°C

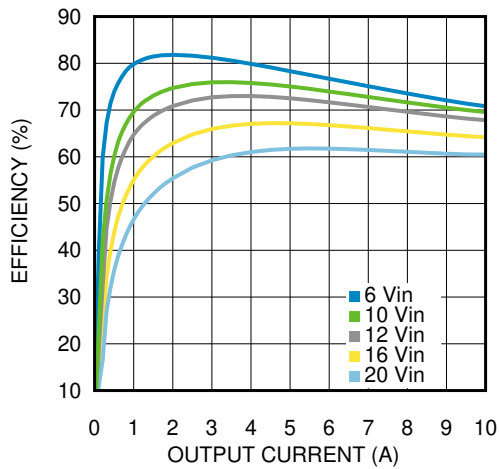


Figure 6-27. Efficiency 1-V Output at 85°C

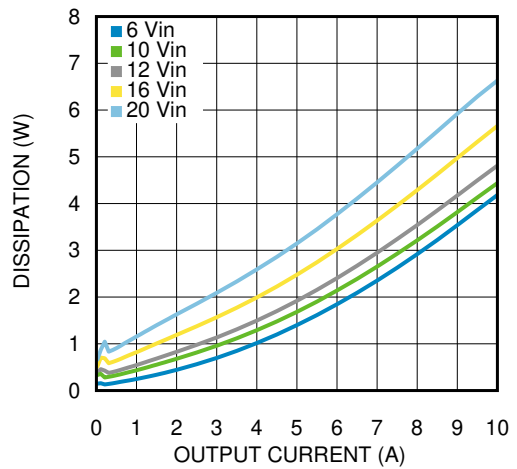


Figure 6-28. Dissipation 1-V Output at 85°C

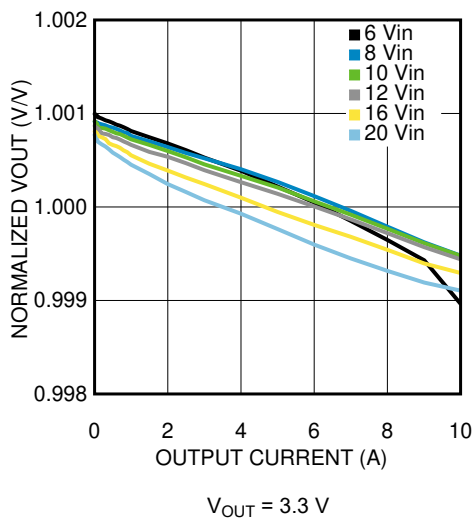


Figure 6-29. Normalized Line and Load Regulation

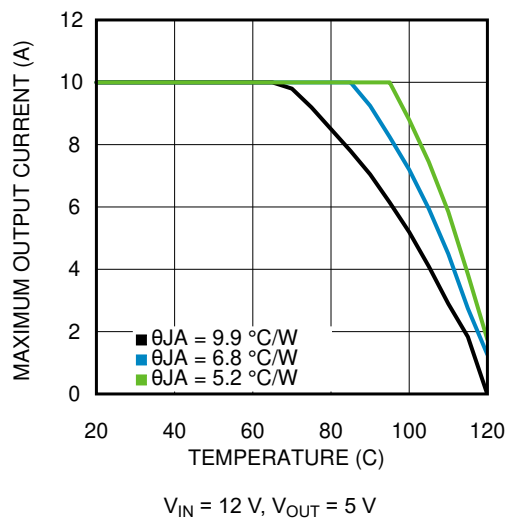
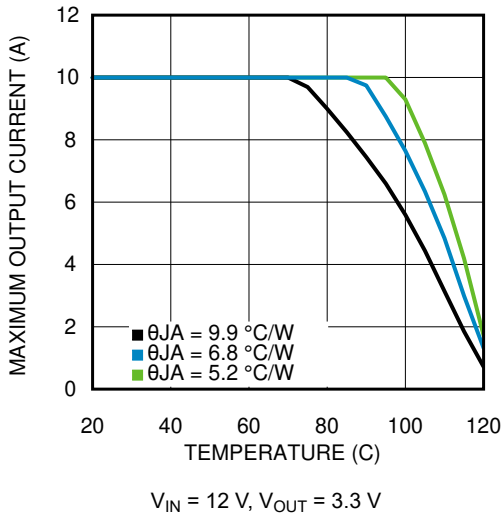
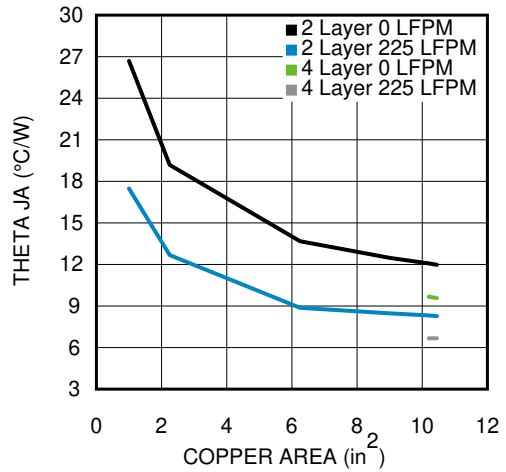


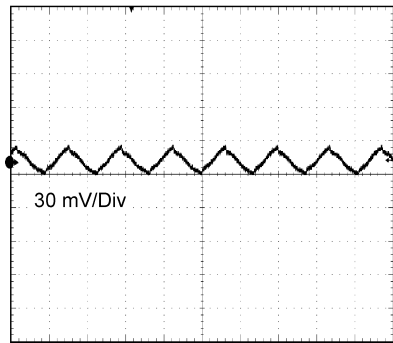
Figure 6-30. Thermal Derating



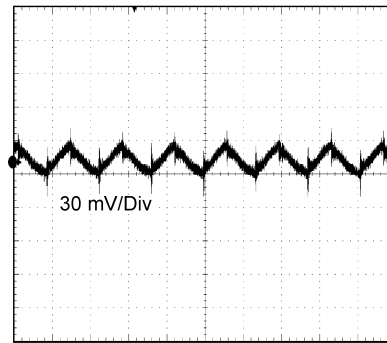
**Figure 6-31. Thermal Derating**



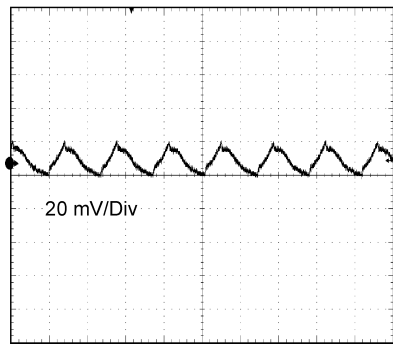
**Figure 6-32.  $R_{\theta_{JA}}$  vs Copper Heat Sinking Area**



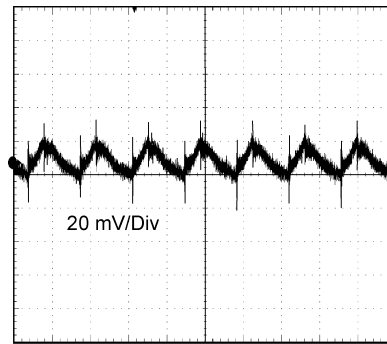
TIME (2  $\mu\text{s}/\text{Div}$ )  
 $12 \text{ V}_{IN}$ ,  $5 \text{ V}_{OUT}$  at Full Load, BW = 20 MHz  
**Figure 6-33. Output Ripple**



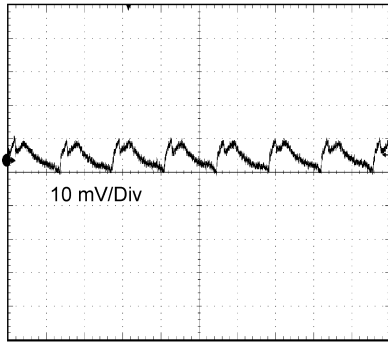
TIME (2  $\mu\text{s}/\text{Div}$ )  
 $12 \text{ V}_{IN}$ ,  $5 \text{ V}_{OUT}$  at Full Load, BW = 250 MHz  
**Figure 6-34. Output Ripple**



TIME (2  $\mu\text{s}/\text{Div}$ )  
 $12 \text{ V}_{IN}$ ,  $3.3 \text{ V}_{OUT}$  at Full Load, BW = 20 MHz  
**Figure 6-35. Output Ripple**



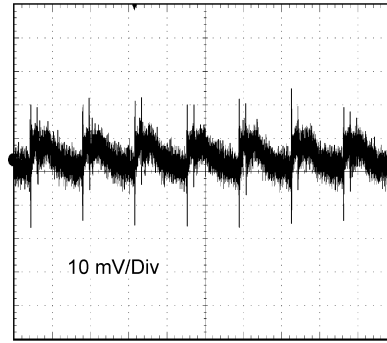
TIME (2  $\mu\text{s}/\text{Div}$ )  
 $12 \text{ V}_{IN}$ ,  $3.3 \text{ V}_{OUT}$  at Full Load, BW = 250 MHz  
**Figure 6-36. Output Ripple**



TIME (2  $\mu$ s/Div)

12 V<sub>IN</sub>, 1.2 V<sub>OUT</sub> at Full Load, BW = 20 MHz

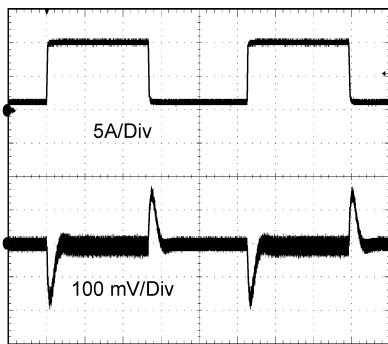
**Figure 6-37. Output Ripple**



TIME (2  $\mu$ s/Div)

12 V<sub>IN</sub>, 1.2 V<sub>OUT</sub> at Full Load, BW = 250 MHz

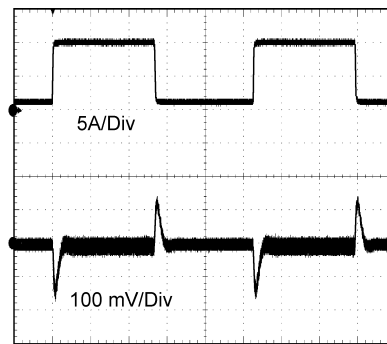
**Figure 6-38. Output Ripple**



TIME (500  $\mu$ s/Div)

12 V<sub>IN</sub>, 5 V<sub>OUT</sub> 1- to 10-A Step

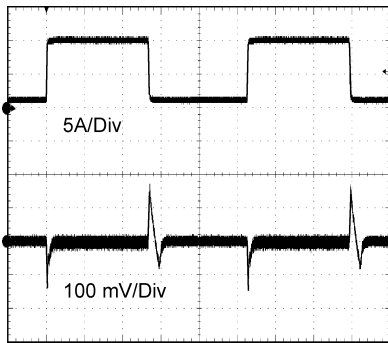
**Figure 6-39. Transient Response**



TIME (500  $\mu$ s/Div)

12 V<sub>IN</sub>, 3.3 V<sub>OUT</sub> 1- to 10-A Step

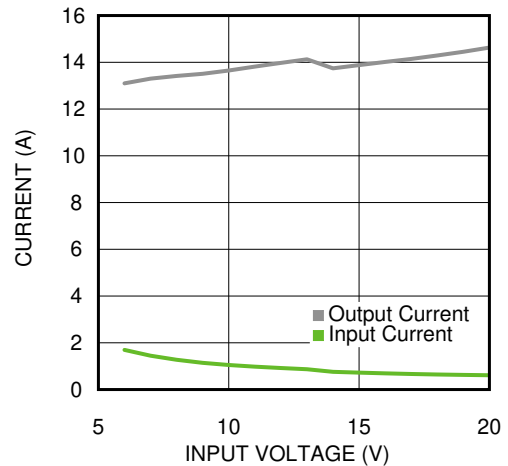
**Figure 6-40. Transient Response**



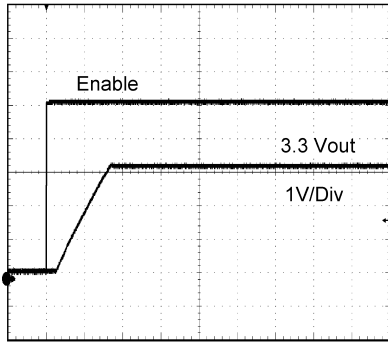
TIME (500  $\mu$ s/Div)

12 V<sub>IN</sub>, 1.2 V<sub>OUT</sub> 1- to 10-A Step

**Figure 6-41. Transient Response**



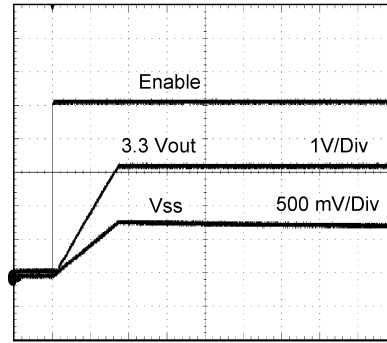
**Figure 6-42. Short Circuit Current vs Input Voltage**



TIME (1 ms/Div)

No  $C_{SS}$

**Figure 6-43. 3.3-V<sub>OUT</sub> Soft Start**



TIME (5 ms/Div)

$C_{SS} = 0.47 \mu\text{F}$

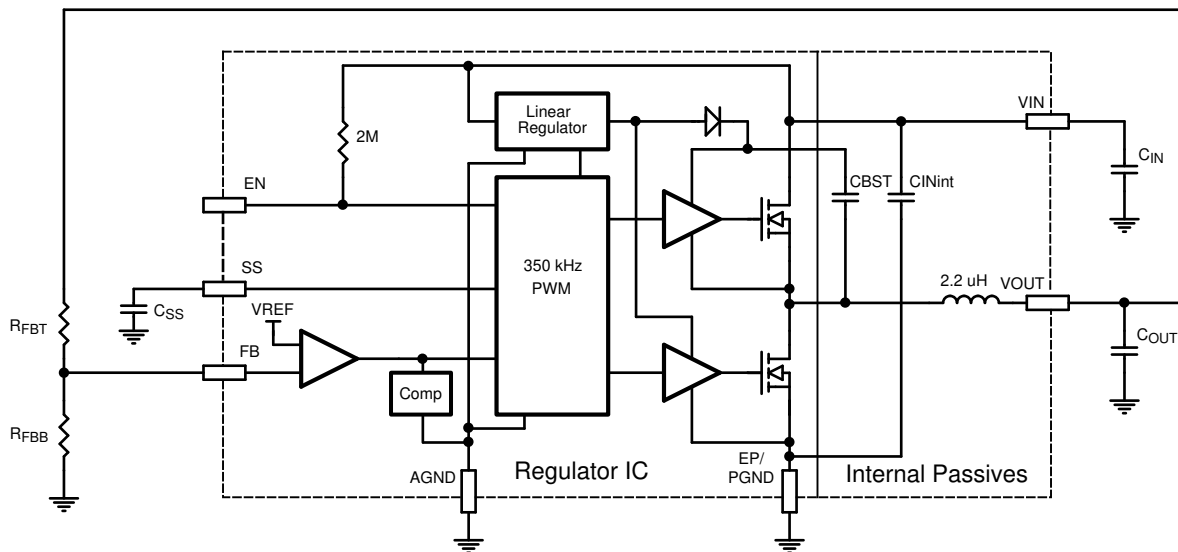
**Figure 6-44. 3.3-V<sub>OUT</sub> Soft Start**

## 7 Detailed Description

### 7.1 Overview

The architecture used is an internally compensated emulated peak current mode control, based on a monolithic synchronous SIMPLE SWITCHER core capable of supporting high load currents. The output voltage is maintained through feedback compared with an internal 0.8-V reference. For emulated peak current mode, the valley current is sampled on the down-slope of the inductor current. This is used as the DC value of current to start the next cycle. The primary application for emulated peak current mode is high input voltage to low output voltage operating at a narrow duty cycle. By sampling the inductor current at the end of the switching cycle and adding an external ramp, the minimum on time can be significantly reduced, without the need for blanking or filtering, which is normally required for peak current mode control.

### 7.2 Functional Block Diagram



### 7.3 Feature Description

#### 7.3.1 Output Overvoltage Protection

If the voltage at FB is greater than a 0.86-V internal reference, the output of the error amplifier is pulled toward ground, causing  $V_{OUT}$  to fall.

#### 7.3.2 Current Limit

The LMZ12010 is protected by both low-side (LS) and high-side (HS) current limit circuitry. The LS current limit detection is carried out during the off time by monitoring the current through the LS synchronous MOSFET. Referring to the [Functional Block Diagram](#), when the top MOSFET is turned off, the inductor current flows through the load, the PGND pin, and the internal synchronous MOSFET. If this current exceeds 13 A (typical), the current limit comparator disables the start of the next switching period. Switching cycles are prohibited until current drops below the limit.

#### Note

DC current limit is dependent on duty cycle as illustrated in the graph in [Section 6.6](#).

The HS current limit monitors the current of top-side MOSFET. Once HS current limit is detected (16 A typical), the HS MOSFET is shut off immediately until the next cycle. Exceeding HS current limit causes  $V_{OUT}$  to fall. Typical behavior of exceeding LS current limit is that  $f_{SW}$  drops to 1/2 of the operating frequency.

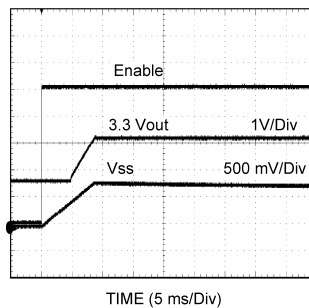
### 7.3.3 Thermal Protection

The junction temperature of the LMZ12010 must not be allowed to exceed its maximum ratings. Thermal protection is implemented by an internal thermal shutdown circuit, which activates at 165°C (typical), causing the device to enter a low power standby state. In this state, the main MOSFET remains off, causing  $V_{OUT}$  to fall, and the  $C_{SS}$  capacitor is discharged to ground. Thermal protection helps prevent catastrophic failures for accidental device overheating. When the junction temperature falls back below 150°C (typical hysteresis = 15°C), the SS pin is released,  $V_{OUT}$  rises smoothly, and normal operation resumes.

Applications requiring maximum output current, especially those at high input voltages, can require additional derating at elevated temperatures.

### 7.3.4 Prebiased Start-Up

The LMZ12010 will properly start up into a prebiased output. This start-up situation is common in multiple rail logic applications where current paths can exist between different power rails during the start-up sequence. [Figure 7-1](#) shows proper behavior in this mode. Trace one is Enable going high. Trace two is 1.8-V prebias rising to 3.3 V. Trace three is the SS voltage with a  $C_{SS} = 0.47 \mu\text{F}$ . Rise time is determined by  $C_{SS}$ .



**Figure 7-1. Prebiased Start-Up**

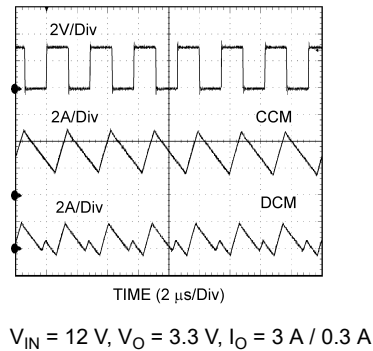
## 7.4 Device Functional Modes

### 7.4.1 Discontinuous Conduction and Continuous Conduction Modes

At light load, the regulator will operate in discontinuous conduction mode (DCM). With load currents above the critical conduction point, it will operate in continuous conduction mode (CCM). When operating in DCM, inductor current is maintained to an average value equaling  $I_{OUT}$ . In DCM, the low-side switch will turn off when the inductor current falls to zero. This causes the inductor current to resonate. Although it is in DCM, the current is allowed to go slightly negative to charge the bootstrap capacitor.

In CCM, current flows through the inductor through the entire switching cycle and never falls to zero during the off time.

Figure 7-2 is a comparison pair of waveforms showing both the CCM (upper) and DCM operating modes.



**Figure 7-2. CCM and DCM Operating Modes**

The approximate formula for determining the DCM/CCM boundary is:

$$I_{DCB} = \frac{(V_{IN} - V_{OUT}) \times D}{2 \times L \times f_{SW}} \quad (1)$$

The inductor internal to the module is 2.2  $\mu$ H. This value was chosen as a good balance between low and high input voltage applications. The main parameter affected by the inductor is the amplitude of the inductor ripple current ( $\Delta i_L$ ).  $\Delta i_L$  can be calculated with:

$$\Delta i_L = \frac{(V_{IN} - V_{OUT}) \times D}{L \times f_{SW}} \quad (2)$$

where

- $V_{IN}$  is the maximum input voltage.
- $f_{SW}$  is typically 359 kHz.

If the output current  $I_{OUT}$  is determined by assuming that  $I_{OUT} = I_L$ , the higher and lower peak of  $\Delta i_L$  can be determined.



## 8 Application and Implementation

### Note

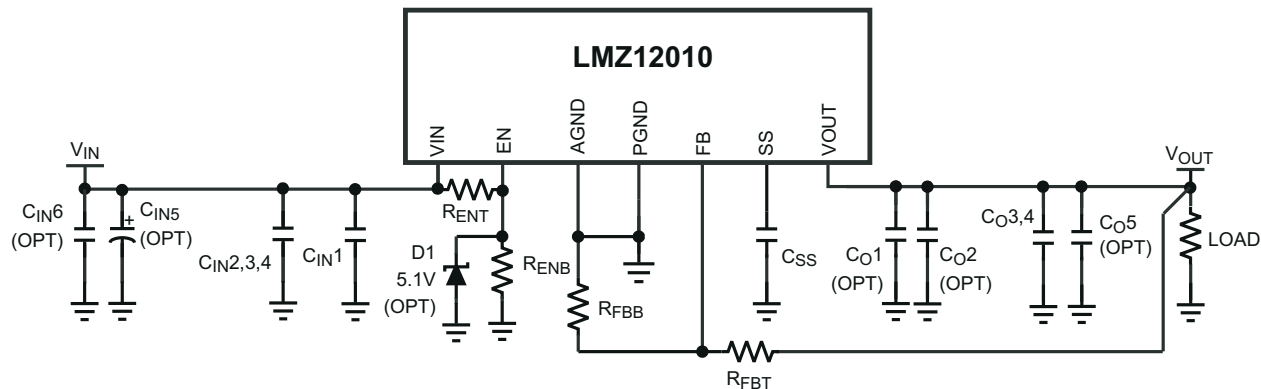
Information in the following applications sections is not part of the TI component specification, and TI does not warrant its accuracy or completeness. TI's customers are responsible for determining suitability of components for their purposes, as well as validating and testing their design implementation to confirm system functionality.

### 8.1 Application Information

The LMZ12010 is a step-down DC-to-DC power module. It is typically used to convert a higher DC voltage to a lower DC voltage with a maximum output current of 10 A. The following design procedure can be used to select components for the LMZ12010. Alternately, the WEBENCH software may be used to generate complete designs.

When generating a design, the WEBENCH software utilizes iterative design procedure and accesses comprehensive databases of components. Please go to [www.ti.com](http://www.ti.com) for more details.

### 8.2 Typical Application



**Figure 8-1. Typical Application Schematic Diagram**

#### 8.2.1 Design Requirements

For this example, the following application parameters exist.

- $V_{IN}$  range = up to 20 V
- $V_{OUT}$  = 0.8 V to 6 V
- $I_{OUT}$  = 10 A

#### 8.2.2 Detailed Design Procedure

The LMZ12010 is fully supported by WEBENCH which offers: component selection, and electrical and thermal simulations. Additionally, there are both evaluation and demonstration boards that can be used as a starting point for design. The following list of steps can be used to manually design the LMZ12010 application.

All references to values refer to the typical applications schematic [Figure 8-1](#).

1. Select minimum operating  $V_{IN}$  with enable divider resistors.
2. Program  $V_{OUT}$  with FB resistor divider selection.
3. Select  $C_{OUT}$ .
4. Select  $C_{IN}$ .
5. Determine module power dissipation,
6. Lay out PCB for required thermal performance.

### 8.2.2.1 Enable Divider, $R_{ENT}$ , $R_{ENB}$ , and $R_{ENH}$ Selection

Internal to the module is a 2-M $\Omega$  pullup resistor connected from  $V_{IN}$  to Enable. For applications not requiring precision undervoltage lockout (UVLO), the Enable input can be left open circuit and the internal resistor will always enable the module. In such case, the internal UVLO occurs typically at 4.3 V ( $V_{IN}$  rising).

In applications with separate supervisory circuits, Enable can be directly interfaced to a logic source. In the case of sequencing supplies, the divider is connected to a rail that becomes active earlier in the power-up cycle than the LMZ12010 output rail.

Enable provides a precise 1.274-V threshold to allow direct logic drive or connection to a voltage divider from a higher enable voltage such as  $V_{IN}$ . Additionally there is 13  $\mu$ A (typical) of switched offset current, allowing programmable hysteresis.

The function of the enable divider is to allow the designer to choose an input voltage below which the circuit will be disabled. This implements the feature of a programmable UVLO. The two resistors must be chosen based on the following ratio:

$$R_{ENT} / R_{ENB} = (V_{IN\ UVLO} / 1.274\ V) - 1 \quad (3)$$

The LMZ12010 typical application shows 12.7 k $\Omega$  for  $R_{ENB}$  and 42.2 k $\Omega$  for  $R_{ENT}$ , resulting in a rising UVLO of 5.51 V. Note that this divider presents 4.62 V to the EN input when  $V_{IN}$  is raised to 20 V. This upper voltage must always be checked, making sure that it never exceeds the absolute maximum 5.5-V limit for Enable. A 5.1-V Zener clamp can be applied in cases where the upper voltage would exceed the range of operation for the EN input. The Zener clamp is not required if the target application prohibits the maximum Enable input voltage from being exceeded.

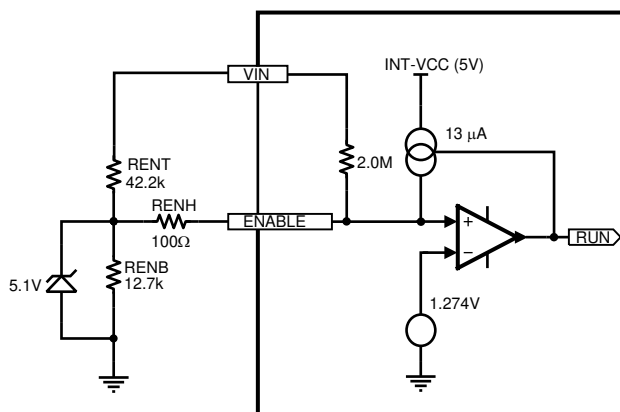
Additional enable voltage hysteresis can be added with the inclusion of  $R_{ENH}$ . It is possible to select values for  $R_{ENT}$  and  $R_{ENB}$  such that  $R_{ENH}$  is a value of zero allowing it to be omitted from the design.

Rising threshold can be calculated as follows:

$$V_{EN(\text{rising})} = 1.274 ( 1 + (R_{ENT} || 2\ \text{meg}) / R_{ENB} ) \quad (4)$$

Whereas the falling threshold level can be calculated using:

$$V_{EN(\text{falling})} = V_{EN(\text{rising})} - 13\ \mu\text{A} ( R_{ENT} || 2\ \text{meg} || R_{ENTB} + R_{ENH} ) \quad (5)$$



**Figure 8-2. Enable Input Detail**

### 8.2.2.2 Output Voltage Selection

Output voltage is determined by a divider of two resistors connected between  $V_{OUT}$  and AGND. The midpoint of the divider is connected to the FB input.

The regulated output voltage determined by the external divider resistors,  $R_{FBT}$  and  $R_{FBB}$ , is:

$$V_{OUT} = 0.795 \text{ V} \times (1 + R_{FBT} / R_{FBB}) \quad (6)$$

Rearranging terms, the ratio of the feedback resistors for a desired output voltage is:

$$R_{FBT} / R_{FBB} = (V_{OUT} / 0.795 \text{ V}) - 1 \quad (7)$$

These resistors must generally be chosen from values in the range of 1.0 kΩ to 10.0 kΩ.

For  $V_{OUT} = 0.8 \text{ V}$ , the FB pin can be connected to the output directly and  $R_{FBB}$  can be set to 8.06 kΩ to provide minimum output load.

Table 8-1 lists the values for  $R_{FBT}$ , and  $R_{FBB}$ .

**Table 8-1. Typical Application Bill of Materials**

Ref Des	Description	Case Size	Manufacturer	Manufacturer P/N
U1	SIMPLE SWITCHER	PFM-11	Texas Instruments	LMZ12010TZ
C <sub>IN</sub> 1,6 (OPT)	0.047 μF, 50 V, X7R	1206	Yageo America	CC1206KRX7R9BB473
C <sub>IN</sub> 2,3,4	10 μF, 50 V, X7R	1210	Taiyo Yuden	UMK325BJ106MM-T
C <sub>IN</sub> 5 (OPT)	CAP, AL, 150 μF, 50 V	Radial G	Panasonic	EEE-FK1H151P
C <sub>O</sub> 1,5 (OPT)	0.047 μF, 50 V, X7R	1206	Yageo America	CC1206KRX7R9BB473
C <sub>O</sub> 2 (OPT)	47 μF, 10 V, X7R	1210	Murata	GRM32ER61A476KE20L
C <sub>O</sub> 3,4	330 μF, 6.3 V, 0.015 Ω	CAPSMT_6_UE	Kemet	T520D337M006ATE015
R <sub>FBT</sub>	3.32 kΩ	0805	Panasonic	ERJ-6ENF3321V
R <sub>FBB</sub>	1.07 kΩ	0805	Panasonic	ERJ-6ENF1071V
R <sub>ENT</sub>	42.2 kΩ	0805	Panasonic	ERJ-6ENF4222V
R <sub>ENB</sub>	12.7 kΩ	0805	Panasonic	ERJ-6ENF1272V
C <sub>SS</sub>	0.47 μF, ±10%, X7R, 16 V	0805	AVX	0805YC474KAT2A
D1 (OPT)	5.1 V, 0.5 W	SOD-123	Diodes Inc.	MMSZ5231BS-7-F

### 8.2.2.3 Soft-Start Capacitor Selection

Programmable soft start permits the regulator to slowly ramp to its steady-state operating point after being enabled, thereby reducing current inrush from the input supply and slowing the output voltage rise time.

Upon turn-on, after all UVLO conditions have been passed, an internal 1.6-ms circuit slowly ramps the SS input to implement internal soft start. If 1.6 ms is an adequate turn-on time, then the C<sub>SS</sub> capacitor can be left unpopulated. Longer soft-start periods are achieved by adding an external capacitor to this input.

Soft-start duration is given by the formula:

$$t_{SS} = V_{REF} \times C_{SS} / I_{SS} = 0.795 \text{ V} \times C_{SS} / 50 \mu\text{A} \quad (8)$$

This equation can be rearranged as follows:

$$C_{SS} = t_{SS} \times 50 \mu\text{A} / 0.795 \text{ V} \quad (9)$$

Using a 0.22-μF capacitor results in 3.5-ms typical soft-start duration and 0.47 μF results in 7.5 ms typical. 0.47 μF is a recommended initial value.

As the soft-start input exceeds 0.795 V, the output of the power stage will be in regulation and the 50-μA current is deactivated. Note that the following conditions will reset the soft-start capacitor by discharging the SS input to ground with an internal current sink.

- The Enable input being *pulled low*
- A thermal shutdown condition
- $V_{IN}$  falling below 4.3 V (typical) and triggering the  $V_{CC}$  UVLO

### 8.2.2.4 Tracking Supply Divider Option

The tracking function allows the module to be connected as a slave supply to a primary voltage rail (often the 3.3-V system rail) where the slave module output voltage is lower than that of the master. Proper configuration allows the slave rail to power up coincident with the master rail such that the voltage difference between the rails during ramp-up is small (that is, < 0.15 V typical). The values for the tracking resistive divider must be selected such that the effect of the internal 50- $\mu$ A current source is minimized. In most cases, the ratio of the tracking divider resistors is the same as the ratio of the output voltage setting divider. Proper operation in tracking mode dictates the soft-start time of the slave rail be shorter than the master rail; a condition that is easy to satisfy because the  $C_{SS}$  capacitor is replaced by  $R_{TKB}$ . The tracking function is only supported for the power-up interval of the master supply; once the SS/TRK rises past 0.795 V, the input is no longer enabled and the 50- $\mu$ A internal current source is switched off.

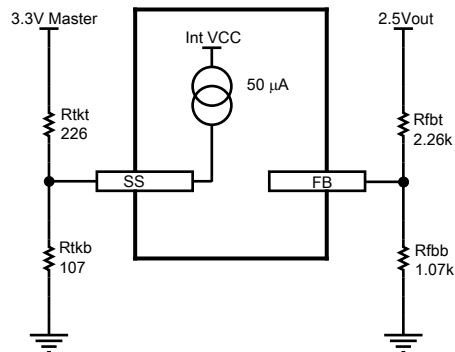


Figure 8-3. Tracking Option Input Detail

### 8.2.2.5 $C_{OUT}$ Selection

None of the required  $C_{OUT}$  output capacitance is contained within the module. A minimum value ranging from 330  $\mu$ F for 6  $V_{OUT}$  to 660  $\mu$ F for 1.2- $V_{OUT}$  applications is required based on the values of internal compensation in the error amplifier. These minimum values can be decreased if the effective capacitor ESR is higher than 15 m $\Omega$ .

A low-ESR (15 m $\Omega$ ) tantalum, organic semiconductor or specialty polymer capacitor types in parallel with a 47-nF X7R ceramic capacitor for high-frequency noise reduction is recommended for obtaining lowest ripple. The output capacitor  $C_{OUT}$  can consist of several capacitors in parallel placed in close proximity to the module. The output voltage ripple of the module depends on the equivalent series resistance (ESR) of the capacitor bank, and can be calculated by multiplying the ripple current of the module by the effective impedance of your chosen output capacitors. Electrolytic capacitors will have large ESR and lead to larger output ripple than ceramic or polymer types. For this reason, a combination of ceramic and polymer capacitors is recommended for low output ripple performance.

The output capacitor assembly must also meet the worst case ripple current rating of  $\Delta i_L$ . Loop response verification is also valuable to confirm closed loop behavior.

For applications with dynamic load steps; Equation 10 provides a good first pass approximation of  $C_{OUT}$  for load transient requirements.

$$C_{OUT} \geq \frac{I_{STEP}}{(\Delta V_{OUT} - I_{STEP} \times ESR) \times \left(\frac{f_{SW}}{V_{OUT}}\right)} \quad (10)$$

For 12  $V_{IN}$ , 3.3  $V_{OUT}$ , a transient voltage of 5% of  $V_{OUT} = 0.165$  V ( $\Delta V_{OUT}$ ), a 9-A load step ( $I_{STEP}$ ), an output capacitor effective ESR of 3 m $\Omega$ , and a switching frequency of 350 kHz ( $f_{SW}$ ):

$$C_{OUT} \geq \frac{9A}{(0.165V - 9A \times 0.003) \times \left(\frac{350e3}{3.3V}\right)} \geq 615 \mu F \quad (11)$$

---

**Note**

The stability requirement for minimum output capacitance must always be met.

---

One recommended output capacitor combination is two 330- $\mu$ F, 15-m $\Omega$  ESR tantalum polymer capacitors connected in parallel with a 47- $\mu$ F 6.3-V X5R ceramic. This combination provides excellent performance that can exceed the requirements of certain applications. Additionally some small 47-nF ceramic capacitors can be used for high-frequency EMI suppression.

### 8.2.2.6 $C_{IN}$ Selection

The LMZ12010 module contains two internal ceramic input capacitors. Additional input capacitance is required external to the module to handle the input ripple current of the application. The input capacitor can be several capacitors in parallel. This input capacitance must be located in very close proximity to the module. Input capacitor selection is generally directed to satisfy the input ripple current requirements rather than by capacitance value. Input ripple current rating is dictated by [Equation 12](#):

$$I_{CIN-RMS} = I_{OUT} \times \sqrt{D(1-D)} \quad (12)$$

where

- $D \cong V_{OUT} / V_{IN}$

As a point of reference, the worst case ripple current will occur when the module is presented with full load current and when  $V_{IN} = 2 \times V_{OUT}$ .

Recommended minimum input capacitance is 30- $\mu$ F X7R (or X5R) ceramic with a voltage rating at least 25% higher than the maximum applied input voltage for the application. TI also recommends to pay attention to the voltage and temperature derating of the capacitor selected.

---

**Note**

Ripple current rating of ceramic capacitors may be missing from the capacitor data sheet and the user may have to contact the capacitor manufacturer for this parameter.

---

If the system design requires a certain minimum value of peak-to-peak input ripple voltage ( $\Delta V_{IN}$ ) to be maintained then [Equation 13](#) may be used.

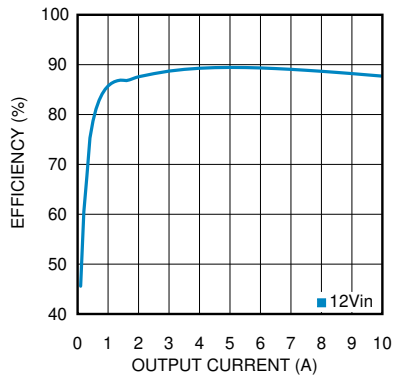
$$C_{IN} \geq \frac{I_{OUT} \times D \times (1 - D)}{f_{SW} \times \Delta V_{IN}} \quad (13)$$

If  $\Delta V_{IN}$  is 200 mV or 1.66% of  $V_{IN}$  for a 12-V input to 3.3-V output application and  $f_{SW} = 350$  kHz then:

$$C_{IN} \geq \frac{10A \times \left(\frac{3.3V}{12V}\right) \times \left(1 - \frac{3.3V}{12V}\right)}{350 \text{ kHz} \times 200 \text{ mV}} \geq 28 \mu F \quad (14)$$

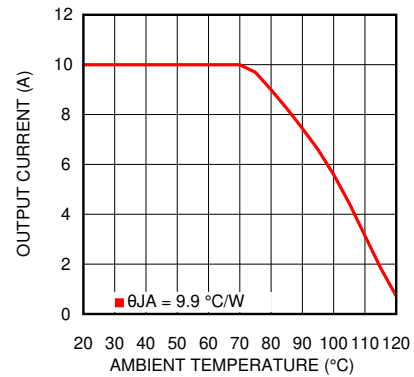
Additional bulk capacitance with higher ESR can be required to damp any resonant effects of the input capacitance and parasitic inductance of the incoming supply lines. The LMZ12010 typical applications schematic and evaluation board include a 150- $\mu$ F 50-V aluminum capacitor for this function. There are many situations where this capacitor is not necessary.

### 8.2.3 Application Curves



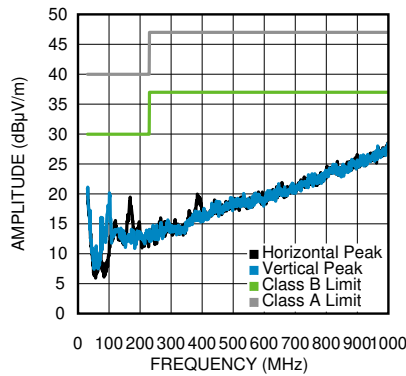
$V_{IN} = 12\text{ V}$ ,  $V_{OUT} = 3.3\text{ V}$

**Figure 8-4. Efficiency**



$V_{IN} = 12\text{ V}$ ,  $V_{OUT} = 3.3\text{ V}$

**Figure 8-5. Thermal Derating Curve**



$V_{IN} = 12\text{ V}$ ,  $V_{OUT} = 5\text{ V}$ ,  $I_{OUT} = 10\text{ A}$

**Figure 8-6. Radiated EMI (EN 55022)**

## 9 Power Supply Recommendations

The LMZ12010 device is designed to operate from an input voltage supply range between 6 V and 20 V. This input supply must be well regulated and able to withstand maximum input current and maintain a stable voltage. The resistance of the input supply rail must be low enough that an input current transient does not cause a high enough drop at the LMZ12010 supply voltage that can cause a false UVLO fault triggering and system reset. If the input supply is more than a few inches from the LMZ12010, additional bulk capacitance can be required in addition to the ceramic bypass capacitors. The amount of bulk capacitance is not critical, but a 47- $\mu$ F or 100- $\mu$ F electrolytic capacitor is a typical choice.

## 10 Layout

### 10.1 Layout Guidelines

PCB layout is an important part of DC-DC converter design. Poor board layout can disrupt the performance of a DC-DC converter and surrounding circuitry by contributing to EMI, ground bounce and resistive voltage drop in the traces. These can send erroneous signals to the DC-DC converter resulting in poor regulation or instability. Good layout can be implemented by following a few simple design rules. A good layout example is shown in [Section 10.2](#).

- **Minimize area of switched current loops.**

From an EMI reduction standpoint, it is imperative to minimize the high di/dt paths during PCB layout. The high current loops that do not overlap have high di/dt content that will cause observable high frequency noise on the output pin if the input capacitor ( $C_{IN}$ ) is placed at a distance away from the LMZ12010. Therefore place  $C_{IN}$  as close as possible to the LMZ12010  $V_{IN}$  and PGND exposed pad. This will minimize the high di/dt area and reduce radiated EMI. Additionally, grounding for both the input and output capacitor must consist of a localized top side plane that connects to the PGND exposed pad (EP).

- **Have a single point ground.**

The ground connections for the feedback, soft-start, and enable components must be routed to the AGND pin of the device. This prevents any switched or load currents from flowing in the analog ground traces. If not properly handled, poor grounding can result in degraded load regulation or erratic output voltage ripple behavior. Additionally provide a single point ground connection from pin 4 (AGND) to EP/PGND.

- **Minimize trace length to the FB pin.**

Both feedback resistors,  $R_{FBT}$  and  $R_{FBB}$  must be located close to the FB pin. Because the FB node is high impedance, maintain the copper area as small as possible. The traces from  $R_{FBT}$ ,  $R_{FBB}$  must be routed away from the body of the LMZ12010 to minimize possible noise pickup.

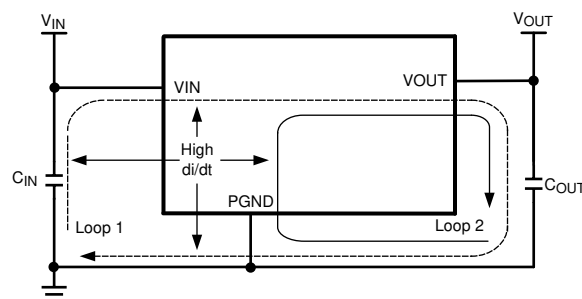
- **Make input and output bus connections as wide as possible.**

This reduces any voltage drops on the input or output of the converter and maximizes efficiency. To optimize voltage accuracy at the load, ensure that a separate feedback voltage sense trace is made to the load. Doing so will correct for voltage drops and provide optimum output accuracy.

- **Provide adequate device heat-sinking.**

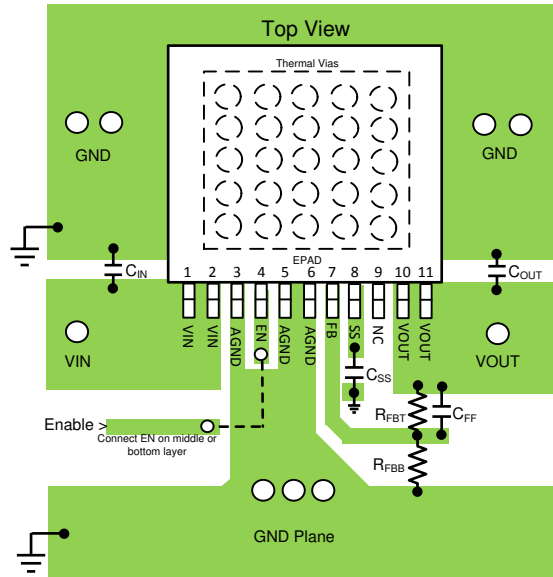
Use an array of heat-sinking vias to connect the exposed pad to the ground plane on the bottom PCB layer. If the PCB has multiple copper layers, these thermal vias can also be connected to inner layer heat-spreading ground planes. For best results use a  $10 \times 10$  via array or larger with a minimum via diameter of 8 mil thermal vias spaced 46.8 mil (1.5 mm). Ensure enough copper area is used for heat-sinking to keep the junction temperature below  $125^{\circ}\text{C}$ .

### 10.2 Layout Examples

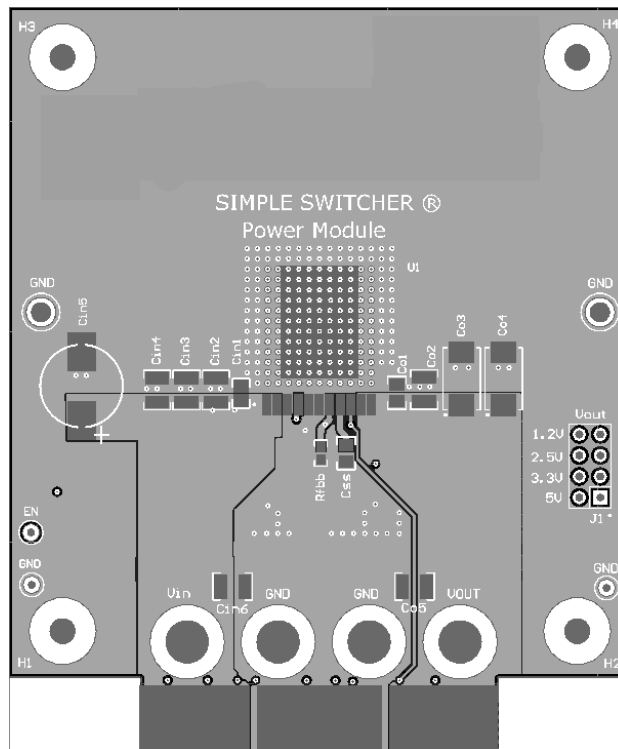


**Figure 10-1. Critical Current Loops to Minimize**

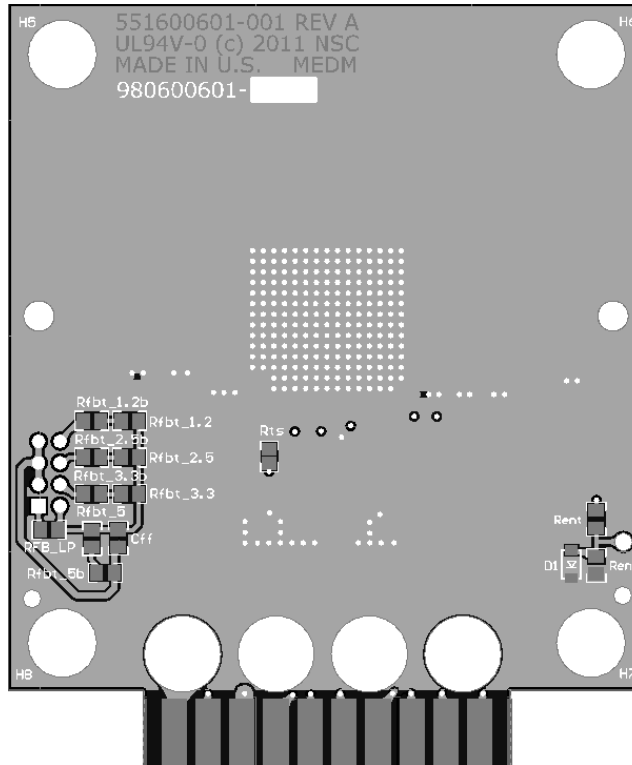




**Figure 10-2. PCB Layout Guide**



**Figure 10-3. Top View of Evaluation PCB**



**Figure 10-4. Bottom View of Evaluation PCB**

### 10.3 Power Dissipation and Thermal Considerations

When calculating module dissipation, use the maximum input voltage and the average output current for the application. Many common operating conditions are provided in the characteristic curves such that less common applications can be derived through interpolation. In all designs, the junction temperature must be kept below the rated maximum of 125°C.

For the design case of  $V_{IN} = 12\text{ V}$ ,  $V_{OUT} = 3.3\text{ V}$ ,  $I_{OUT} = 10\text{ A}$ , and  $T_{A-MAX} = 50^\circ\text{C}$ , the module must see a thermal resistance from case to ambient ( $\theta_{CA}$ ) of less than:

$$\theta_{CA} < \frac{T_{J-MAX} - T_{A-MAX}}{P_{IC\_LOSS}} - \theta_{JC} \quad (15)$$

Given the typical thermal resistance from junction to case ( $\theta_{JC}$ ) to be 1.0°C/W. Use the 85°C power dissipation curves in [Section 6.6](#) to estimate the  $P_{IC\_LOSS}$  for the application being designed. In this application it is 5.3 W.

$$\theta_{CA} < \frac{125^\circ\text{C} - 50^\circ\text{C}}{5.3\text{ W}} - 1.0 \frac{^\circ\text{C}}{\text{W}} < 13.15 \frac{^\circ\text{C}}{\text{W}} \quad (16)$$

To reach  $\theta_{CA} = 13.15$ , the PCB is required to dissipate heat effectively. With no airflow and no external heat-sink, a good estimate of the required board area covered by 2-oz. copper on both the top and bottom metal layers is:

$$\text{Board Area}_{\text{cm}^2} \geq \frac{500}{\theta_{CA}} \cdot \frac{^\circ\text{C} \times \text{cm}^2}{\text{W}} \quad (17)$$

As a result, approximately 38.02 square cm of 2-oz. copper on top and bottom layers is the minimum required area for the example PCB design. This is a 6.16-cm × 6.16-cm (2.42-in × 2.42-in) square. The PCB copper heat

sink must be connected to the exposed pad. For best performance, use approximately 100 8-mil thermal vias spaced 59 mil (1.5 mm) apart connect the top copper to the bottom copper.

Another way to estimate the temperature rise of a design is using  $\theta_{JA}$ . An estimate of  $\theta_{JA}$  for varying heat sinking copper areas and airflows can be found in the typical applications curves. If our design required the same operating conditions as before but had 225 LFPM of airflow. The required  $\theta_{JA}$  is located:

$$\theta_{JA} < \frac{T_{J-MAX} - T_{A-MAX}}{P_{IC\_LOSS}}$$

$$\theta_{JA} < \frac{(125 - 50) \text{ }^{\circ}\text{C}}{5.3 \text{ W}} < 14.15 \frac{\text{ }^{\circ}\text{C}}{\text{W}} \tag{18}$$

On the  $\theta_{JA}$  vs copper heatsinking curve, the copper area required for this application is now only two square inches. The airflow reduced the required heat sinking area by a factor of three.

To reduce the heat sinking copper area further, this package is compatible with D3-PAK surface mount heat sinks.

For an example of a high thermal performance PCB layout for SIMPLE SWITCHER power modules, refer to the following:

- [AN-2093 LMZ23610/8/6 and LMZ22010/8/6 Current Sharing Evaluation Board](#) user's guide
- [AN-2084 LMZ1420xEXT / LMZ1200xEXT Evaluation Board](#) user's guide
- [Step-Down DC-DC Converter with Integrated Low Dropout Regulator and Startup Mode](#) data sheet
- [AN-2020 Thermal Design By Insight, Not Hindsight](#) application report
- [AN-2026 Effect of PCB Design on Thermal Performance of SIMPLE SWITCHER Modules](#) application report

#### 10.4 Power Module SMT Guidelines

The recommendations below are for a standard module surface mount assembly

- Land Pattern — Follow the PCB land pattern with either soldermask defined or non-soldermask defined pads.
- Stencil Aperture
  - For the exposed die attach pad (DAP), adjust the stencil for approximately 80% coverage of the PCB land pattern.
  - For all other I/O pads, use a 1:1 ratio between the aperture and the land pattern recommendation.
- Solder Paste — Use a standard SAC Alloy such as SAC 305, type 3 or higher.
- Stencil Thickness — 0.125 to 0.15 mm
- Reflow — Refer to solder paste supplier recommendation and optimized per board size and density.
- Refer to the [Design Summary LMZ1xxx and LMZ2xxx Power Modules Family](#) application report for reflow information.
- Maximum number of reflows allowed is one.

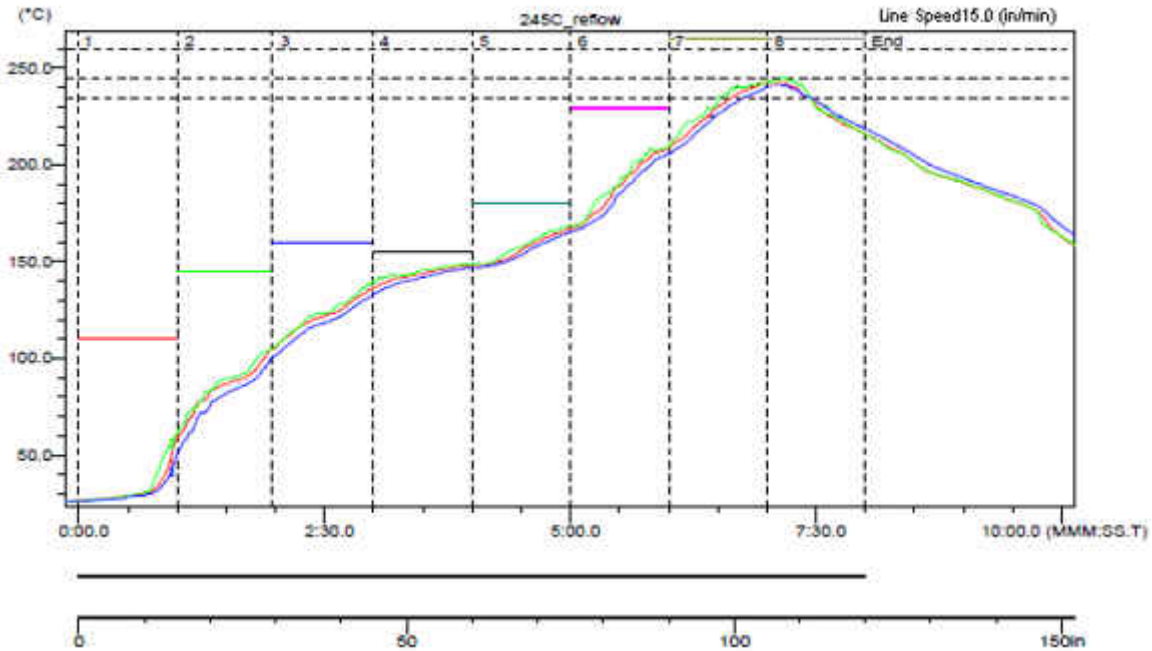


Figure 10-5. Sample Reflow Profile

Table 10-1. Sample Reflow Profile Table

Probe	Max Temp (°C)	Reached Max Temp	Time Above 235°C	Reached 235°C	Time Above 245°C	Reached 245°C	Time Above 260°C	Reached 260°C
1	242.5	6.58	0.49	6.39	0.00	—	0.00	—
2	242.5	7.10	0.55	6.31	0.00	7.10	0.00	—
3	241.0	7.09	0.42	6.44	0.00	—	0.00	—

## 11 Device and Documentation Support

### 11.1 Device Support

#### 11.1.1 Third-Party Products Disclaimer

TI'S PUBLICATION OF INFORMATION REGARDING THIRD-PARTY PRODUCTS OR SERVICES DOES NOT CONSTITUTE AN ENDORSEMENT REGARDING THE SUITABILITY OF SUCH PRODUCTS OR SERVICES OR A WARRANTY, REPRESENTATION OR ENDORSEMENT OF SUCH PRODUCTS OR SERVICES, EITHER ALONE OR IN COMBINATION WITH ANY TI PRODUCT OR SERVICE.

#### 11.1.2 Development Support

For developmental support, see the following:

WEBENCH Tool, <http://www.ti.com/webench>

### 11.2 Documentation Support

#### 11.2.1 Related Documentation

For related documentation, see the following:

- Texas Instruments, [Inverting Application for the LMZ14203 SIMPLE SWITCHER Power Module](#) application report
- Texas Instruments, [Absolute Maximum Ratings for Soldering](#) application report
- Texas Instruments, [LMZ1420x / LMZ1200x Evaluation Board](#) application report
- Texas Instruments, [LMZ23605/03, LMZ22005/03 Evaluation Board](#) application report
- Texas Instruments, [Evaluation Board for LM10000 - PowerWise AVS System Controller](#) application report
- Texas Instruments, [Thermal Design By Insight, Not Hindsight](#) application report
- Texas Instruments, [LMZ23610/8/6 and LMZ22010/8/6 Current Sharing Evaluation Board](#) application report
- Texas Instruments, [LMZ23605/03, LMZ22005/03 Demonstration Board](#) data sheet
- Texas Instruments, [Effect of PCB Design on Thermal Performance of SIMPLE SWITCHER Power Modules](#) application report
- Texas Instruments, [Design Summary LMZ1xxx and LMZ2xxx Power Modules Family](#) application report

### 11.3 Support Resources

TI E2E™ [support forums](#) are an engineer's go-to source for fast, verified answers and design help — straight from the experts. Search existing answers or ask your own question to get the quick design help you need.

Linked content is provided "AS IS" by the respective contributors. They do not constitute TI specifications and do not necessarily reflect TI's views; see TI's [Terms of Use](#).

### 11.4 Receiving Notification of Documentation Updates

To receive notification of documentation updates, navigate to the device product folder on [ti.com](http://ti.com). Click on [Subscribe to updates](#) to register and receive a weekly digest of any product information that has changed. For change details, review the revision history included in any revised document.

### 11.5 Trademarks

TI E2E™ is a trademark of Texas Instruments.

WEBENCH® and SIMPLE SWITCHER® are registered trademarks of Texas Instruments.

All trademarks are the property of their respective owners.

### 11.6 Electrostatic Discharge Caution



This integrated circuit can be damaged by ESD. Texas Instruments recommends that all integrated circuits be handled with appropriate precautions. Failure to observe proper handling and installation procedures can cause damage.

ESD damage can range from subtle performance degradation to complete device failure. Precision integrated circuits may be more susceptible to damage because very small parametric changes could cause the device not to meet its published specifications.

## 11.7 Glossary

[TI Glossary](#) This glossary lists and explains terms, acronyms, and definitions.

## 12 Mechanical, Packaging, and Orderable Information

The following pages include mechanical, packaging, and orderable information. This information is the most current data available for the designated devices. This data is subject to change without notice and revision of this document. For browser-based versions of this data sheet, refer to the left-hand navigation.

**PACKAGING INFORMATION**

Orderable Device	Status (1)	Package Type	Package Drawing	Pins	Package Qty	Eco Plan (2)	Lead finish/ Ball material (6)	MSL Peak Temp (3)	Op Temp (°C)	Device Marking (4/5)	Samples
LMZ12010TZ/NOPB	ACTIVE	PFM	NDY	11	32	RoHS & Green	SN	Level-3-245C-168 HR	-40 to 85	LMZ12010	<a href="#">Samples</a>
LMZ12010TZE/NOPB	ACTIVE	PFM	NDY	11	250	RoHS & Green	SN	Level-3-245C-168 HR	-40 to 85	LMZ12010	<a href="#">Samples</a>

(1) The marketing status values are defined as follows:

**ACTIVE:** Product device recommended for new designs.

**LIFEBUY:** TI has announced that the device will be discontinued, and a lifetime-buy period is in effect.

**NRND:** Not recommended for new designs. Device is in production to support existing customers, but TI does not recommend using this part in a new design.

**PREVIEW:** Device has been announced but is not in production. Samples may or may not be available.

**OBSOLETE:** TI has discontinued the production of the device.

(2) **RoHS:** TI defines "RoHS" to mean semiconductor products that are compliant with the current EU RoHS requirements for all 10 RoHS substances, including the requirement that RoHS substance do not exceed 0.1% by weight in homogeneous materials. Where designed to be soldered at high temperatures, "RoHS" products are suitable for use in specified lead-free processes. TI may reference these types of products as "Pb-Free".

**RoHS Exempt:** TI defines "RoHS Exempt" to mean products that contain lead but are compliant with EU RoHS pursuant to a specific EU RoHS exemption.

**Green:** TI defines "Green" to mean the content of Chlorine (Cl) and Bromine (Br) based flame retardants meet JS709B low halogen requirements of <=1000ppm threshold. Antimony trioxide based flame retardants must also meet the <=1000ppm threshold requirement.

(3) MSL, Peak Temp. - The Moisture Sensitivity Level rating according to the JEDEC industry standard classifications, and peak solder temperature.

(4) There may be additional marking, which relates to the logo, the lot trace code information, or the environmental category on the device.

(5) Multiple Device Markings will be inside parentheses. Only one Device Marking contained in parentheses and separated by a "~" will appear on a device. If a line is indented then it is a continuation of the previous line and the two combined represent the entire Device Marking for that device.

(6) Lead finish/Ball material - Orderable Devices may have multiple material finish options. Finish options are separated by a vertical ruled line. Lead finish/Ball material values may wrap to two lines if the finish value exceeds the maximum column width.

**Important Information and Disclaimer:**The information provided on this page represents TI's knowledge and belief as of the date that it is provided. TI bases its knowledge and belief on information provided by third parties, and makes no representation or warranty as to the accuracy of such information. Efforts are underway to better integrate information from third parties. TI has taken and continues to take reasonable steps to provide representative and accurate information but may not have conducted destructive testing or chemical analysis on incoming materials and chemicals. TI and TI suppliers consider certain information to be proprietary, and thus CAS numbers and other limited information may not be available for release.

In no event shall TI's liability arising out of such information exceed the total purchase price of the TI part(s) at issue in this document sold by TI to Customer on an annual basis.



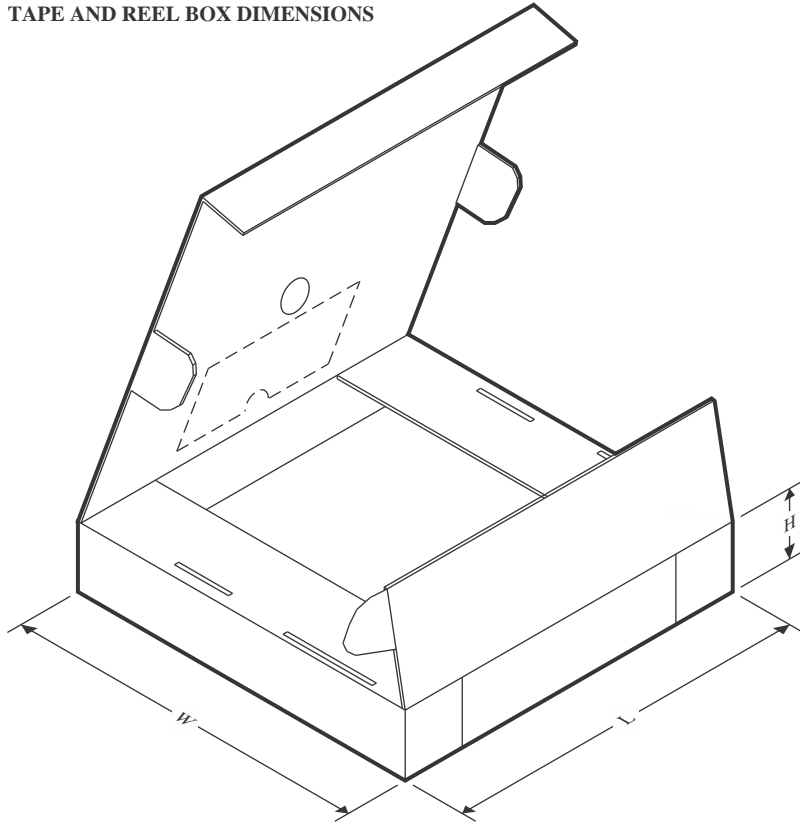


**TAPE AND REEL INFORMATION**

**QUADRANT ASSIGNMENTS FOR PIN 1 ORIENTATION IN TAPE**


\*All dimensions are nominal

Device	Package Type	Package Drawing	Pins	SPQ	Reel Diameter (mm)	Reel Width W1 (mm)	A0 (mm)	B0 (mm)	K0 (mm)	P1 (mm)	W (mm)	Pin1 Quadrant
LMZ12010TZE/NOPB	PFM	NDY	11	250	330.0	32.4	15.45	18.34	6.2	20.0	32.0	Q2

**TAPE AND REEL BOX DIMENSIONS**


\*All dimensions are nominal

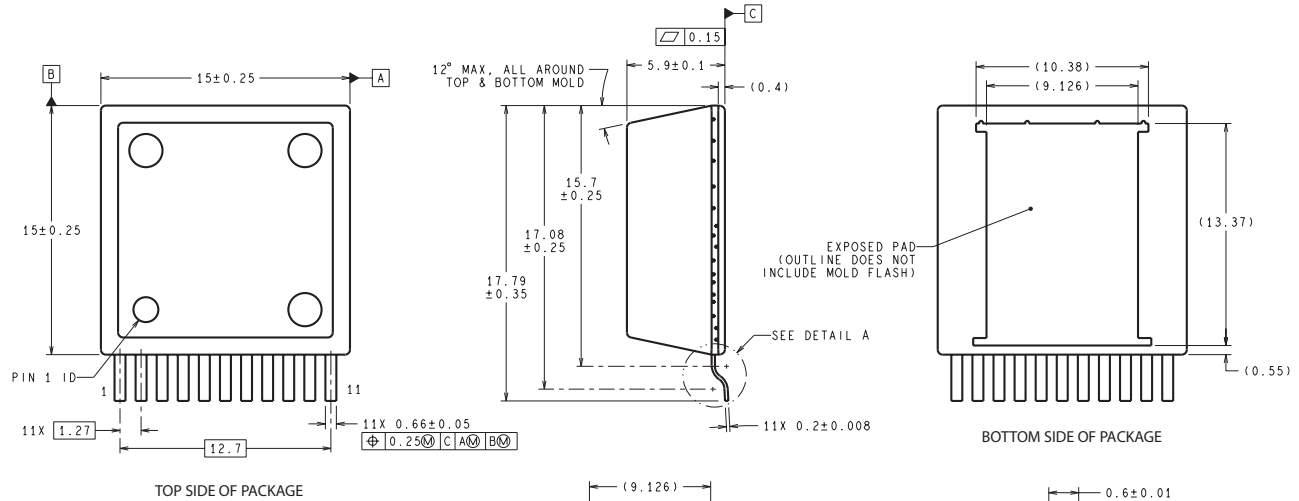
Device	Package Type	Package Drawing	Pins	SPQ	Length (mm)	Width (mm)	Height (mm)
LMZ12010TZE/NOPB	PFM	NDY	11	250	367.0	367.0	55.0

**TUBE**

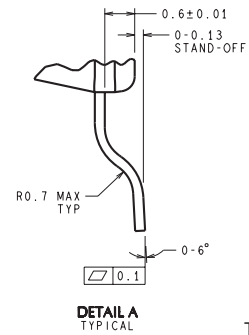
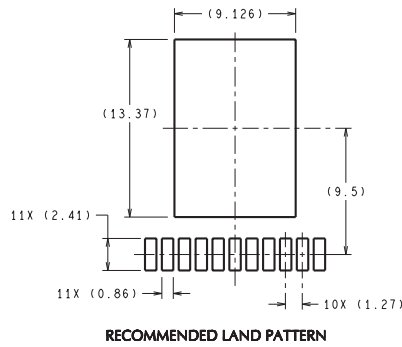

\*All dimensions are nominal

Device	Package Name	Package Type	Pins	SPQ	L (mm)	W (mm)	T (μm)	B (mm)
LMZ12010TZ/NOPB	NDY	TO-PMOD	11	32	502	22	7500	13.1

NDY0011A



DIMENSIONS ARE IN MILLIMETERS  
DIMENSIONS IN ( ) FOR REFERENCE ONLY



TZA11A (Rev F)

## IMPORTANT NOTICE AND DISCLAIMER

TI PROVIDES TECHNICAL AND RELIABILITY DATA (INCLUDING DATA SHEETS), DESIGN RESOURCES (INCLUDING REFERENCE DESIGNS), APPLICATION OR OTHER DESIGN ADVICE, WEB TOOLS, SAFETY INFORMATION, AND OTHER RESOURCES "AS IS" AND WITH ALL FAULTS, AND DISCLAIMS ALL WARRANTIES, EXPRESS AND IMPLIED, INCLUDING WITHOUT LIMITATION ANY IMPLIED WARRANTIES OF MERCHANTABILITY, FITNESS FOR A PARTICULAR PURPOSE OR NON-INFRINGEMENT OF THIRD PARTY INTELLECTUAL PROPERTY RIGHTS.

These resources are intended for skilled developers designing with TI products. You are solely responsible for (1) selecting the appropriate TI products for your application, (2) designing, validating and testing your application, and (3) ensuring your application meets applicable standards, and any other safety, security, regulatory or other requirements.

These resources are subject to change without notice. TI grants you permission to use these resources only for development of an application that uses the TI products described in the resource. Other reproduction and display of these resources is prohibited. No license is granted to any other TI intellectual property right or to any third party intellectual property right. TI disclaims responsibility for, and you will fully indemnify TI and its representatives against, any claims, damages, costs, losses, and liabilities arising out of your use of these resources.

TI's products are provided subject to [TI's Terms of Sale](#) or other applicable terms available either on [ti.com](http://ti.com) or provided in conjunction with such TI products. TI's provision of these resources does not expand or otherwise alter TI's applicable warranties or warranty disclaimers for TI products.

TI objects to and rejects any additional or different terms you may have proposed.

Mailing Address: Texas Instruments, Post Office Box 655303, Dallas, Texas 75265  
Copyright © 2022, Texas Instruments Incorporated