

# LOG300 40MHz, 98dB Logarithmic Detector With Integrated Low-Noise Amplifier

## 1 Features

- Input range:
  - LNA + log detector:  $7\mu\text{V}_\text{P}$  to  $200\text{mV}_\text{P}$
  - Log detector:  $20\mu\text{V}_\text{P}$  to  $1.6\text{V}_\text{P}$
- Adjustable output to input slope and response time.
- Dynamic range: 98dB with log conformance error (LCE) =  $\pm 1\text{dB}$
- Signal detection up to 40MHz; even higher with reduced LCE
- Input frequency detection, zero cross detect
- Supply: 3V to 5.25V

## 2 Applications

- [Ultrasonic distance and material sensing](#)
- [Flow cytometry](#)
- [ESD and high energy EMI signal detection](#)
- [Energy detection](#)
- [Bubble, occlusion detection](#)

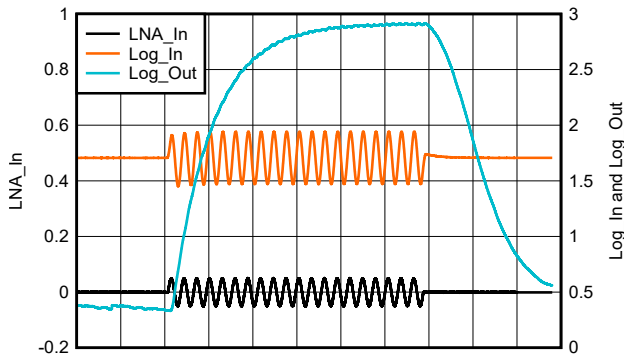

## 3 Description

The LOG300 is an integrated analog front end (AFE) consisting of low-noise amplifier (LNA) and a Log Detector block. This device supports an input frequency range of up-to 40MHz and a typical dynamic range of 98dB. The LOG300 is intended for use in applications that require a wide dynamic range of voltage and signal measurement. The Log Detector block of LOG300 supports both single-ended and differential inputs. The low input noise of the integrated LNA, allows measurement of signals as low as  $7\mu\text{V}_\text{P}$ . The transient output response can be adjusted by tuning the capacitor connected at the Log\_Out pin. The integrated frequency detect feature of LOG300 enables users to extract input signal frequency and zero-crossing information.

The LOG300 is available in a 16-pin SOIC and 16-pin VQFN package. The LOG300 is operational from a 3V to 5.25V supply and over the full ambient temperature range of  $-40^\circ\text{C}$  to  $+125^\circ\text{C}$ .

### Package Information

PART NUMBER	PACKAGE <sup>(1)</sup>	PACKAGE SIZE <sup>(2)</sup>
LOG300	D (SOIC, 16)	9.9mm × 6mm
	RGT (VQFN, 16)	3mm × 3mm

(1) For more information, see [Section 11](#).

(2) The package size (length × width) is a nominal value and includes pins, where applicable.

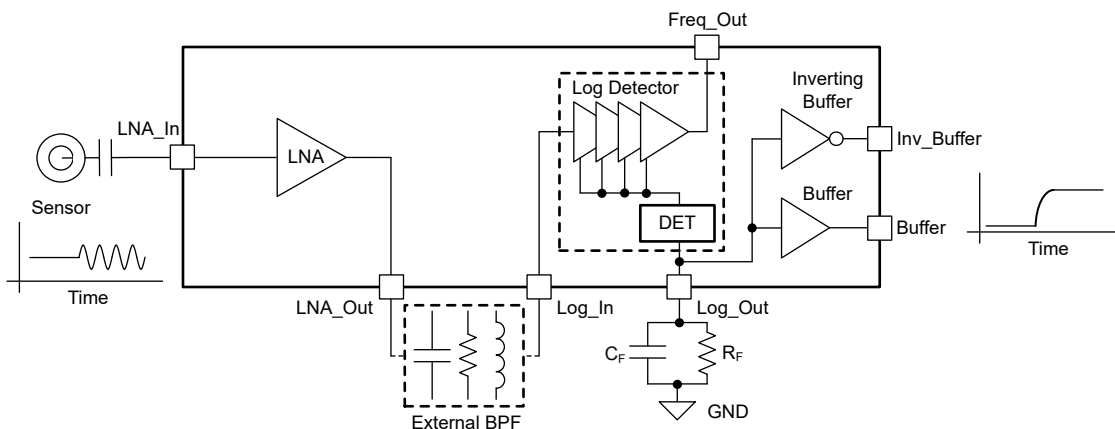

Logarithmic Detector and Envelope Detector



## Table of Contents

<b>1 Features</b> .....	1	7.2 Functional Block Diagram.....	17
<b>2 Applications</b> .....	1	7.3 Feature Description.....	17
<b>3 Description</b> .....	1	7.4 Device Functional Modes.....	19
<b>4 Pin Configuration and Functions</b> .....	3	<b>8 Application and Implementation</b> .....	20
<b>5 Specifications</b> .....	4	8.1 Application Information.....	20
5.1 Absolute Maximum Ratings .....	4	8.2 Typical Application.....	20
5.2 ESD Ratings.....	4	8.3 Power Supply Recommendations.....	22
5.3 Recommended Operating Conditions.....	4	8.4 Layout.....	23
5.4 Thermal Information.....	5	<b>9 Device and Documentation Support</b> .....	24
5.5 Electrical Characteristics Low Noise Amplifier (LNA) .....	5	9.1 Third-Party Products Disclaimer.....	24
5.6 Electrical Characteristics Log Detector.....	6	9.2 Receiving Notification of Documentation Updates....	24
5.7 Electrical Characteristics LNA + Log Detector (AFE).....	8	9.3 Support Resources.....	24
5.8 Typical Characteristics: VCC = 5V.....	9	9.4 Trademarks.....	24
5.9 Typical Characteristics: VCC = 3.3V .....	15	9.5 Electrostatic Discharge Caution.....	24
<b>6 Parameter Measurement Information</b> .....	16	9.6 Glossary.....	24
<b>7 Detailed Description</b> .....	17	<b>10 Revision History</b> .....	24
7.1 Overview.....	17	<b>11 Mechanical, Packaging, and Orderable Information</b> .....	25

## 4 Pin Configuration and Functions

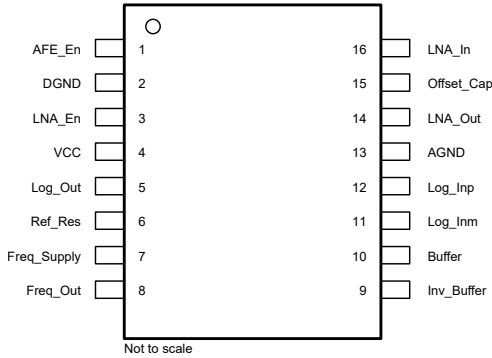

Figure 4-1. D Package, 16-Pin SOIC (top view)

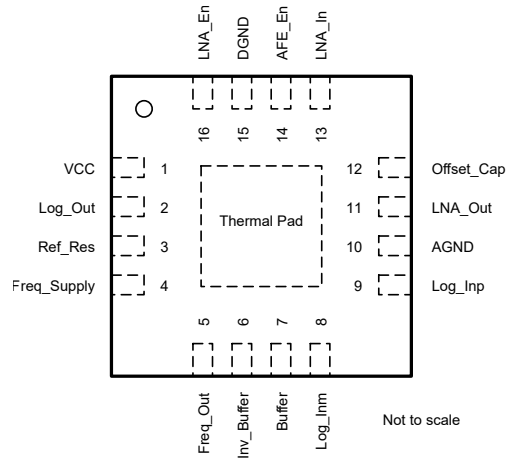

Figure 4-2. RGT Package, 16-Pin VQFN (top view)

Table 4-1. Pin Functions

NAME	PIN		TYPE <sup>(1)</sup>	DESCRIPTION
	D (SOIC)	RGT (VQFN)		
AFE_En	1	14	I	LNA and Log Detector block enable and disable pin. AFE_En = High for AFE enable. Floating this pin keeps both blocks enabled as well.
AGND	13	10	P	Analog ground for LNA and Log detector block
Buffer	10	7	O	Noninverting buffered output. $V_{\text{Buffer}} = V_{\text{Log\_Out}} \times 2$ .
DGND	2	15	P	Digital ground for Freq_Out pin
Freq_Out	8	5	O	This pin toggles at the same signal frequency applied at the Log_In.
Freq_Supply	7	4	P	Power supply for Freq_Out function. Float this pin if the frequency-detection feature is not required.
Inv_Buffer	9	6	O	Inverted buffered output. $V_{\text{Inv\_Buffer}} = V_{\text{CC}} - V_{\text{Log\_Out}} \times 2$ .
LNA_En	3	16	I	Low-noise amplifier enable and disable. LNA_En = High for LNA enable. Floating this pin keeps the LNA enabled as well.
LNA_In	16	13	I	Low-noise amplifier input
LNA_Out	14	11	O	Low-noise amplifier output
Log_Inm	11	8	I	Inverting input of Log Detector block. Connect an appropriate capacitor to ground when used in a single-ended input. Refer to <a href="#">Section 7.3.2</a> .
Log_Inp	12	9	I	Noninverting input of Log Detector block
Log_Out	5	2	O	Unbuffered output of Log Detector block. Connect an appropriate resistor $R_F$ (to set the input to output slope) and capacitor $C_F$ (to set the response time).
Offset_Cap	15	12	I	Connect a recommended capacitor from this pin to ground. This capacitor sets the pole of the internal offset correction loop. Refer to <a href="#">Section 7.3.1</a> for the recommended capacitor.
Ref_Res	6	3	I	Connect a 1% 56kΩ resistor to this pin. Float this pin if the default relaxed slope accuracy is acceptable.
VCC	4	1	P	Supply
Thermal Pad	—	Thermal Pad	P	Thermal pad. Electrically isolated from the device. Connect to a heat spreading plane, typically ground.

(1) I = input, O = output, I/O = input or output, G = ground, P = power.

## 5 Specifications

### 5.1 Absolute Maximum Ratings

Over operating free-air temperature range (unless otherwise noted)<sup>(1)</sup>

		MIN	MAX	UNIT
VCC	Supply voltage and Freq_Supply		5.5	V
	Supply turn-on and turn-off maximum dV/dT <sup>(3)</sup>		1	V/μs
	AFE_En and LNA_En	GND–0.5	VCC+0.5	V
LNA_In	LNA input voltage		±1	V <sub>P</sub>
Log_In	Single ended input voltage (Log_Inp and Log_Inm)		(VCC × 0.17) + 0.9	V <sub>P</sub>
I <sub>I</sub>	Continuous input current for all pins <sup>(2)</sup>		±10	mA
	Continuous power dissipation	See Thermal Information		
T <sub>J</sub>	Maximum junction temperature		150	°C
T <sub>stg</sub>	Storage temperature	–65	150	°C

- (1) Operation outside the *Absolute Maximum Ratings* can cause permanent device damage. *Absolute Maximum Ratings* do not imply functional operation of the device at these or any other conditions beyond those listed under *Recommended Operating Conditions*. If used outside the *Recommended Operating Conditions* but within the *Absolute Maximum Ratings*, the device may not be fully functional, and this may affect device reliability, functionality, performance, and shorten the device lifetime.
- (2) Input pins are diode-clamped to the power-supply rails. Current limit the input signals, which can swing more than 0.5V beyond the supply rails to 10mA or less. Can be easily achieved with a RC filter on VCC.
- (3) Do not exceed this ± supply turn-on edge rate to prevent the edge-triggered ESD absorption device across the supply pins from turning on.

### 5.2 ESD Ratings

			VALUE	UNIT
V <sub>(ESD)</sub>	Electrostatic discharge	Human-body model (HBM), per ANSI/ESDA/JEDEC JS-001 <sup>(1)</sup>	±1000	V
		Charged-device model (CDM), per ANSI/ESDA/JEDEC JS-002 <sup>(2)</sup>	±500	V

- (1) JEDEC document JEP155 states that 500V HBM allows safe manufacturing with a standard ESD control process.
- (2) JEDEC document JEP157 states that 250V CDM allows safe manufacturing with a standard ESD control process.

### 5.3 Recommended Operating Conditions

over operating free-air temperature range (unless otherwise noted)

		MIN	NOM	MAX	UNIT
VCC	Supply voltage	3		5.25	V
T <sub>A</sub>	Ambient temperature	–40	25	125	°C
Ref_Res	Recommended reference resistor to ground		56		kΩ
Log_In	Log detector input at 3.3V VCC <sup>(1)</sup>			1.2	V <sub>P</sub>
	Log detector input at 5V VCC <sup>(1)</sup>			1.6	

- (1) At room temperature, irrespective of the frequency and waveform of the input signal.

## 5.4 Thermal Information

THERMAL METRIC <sup>(1)</sup>		LOG300		UNIT
		D (SOIC)	VQFN (RGT)	
		16 PINS	16 PINS	
R <sub>θJA</sub>	Junction-to-ambient thermal resistance	81.1	48.2	°C/W
R <sub>θJC(top)</sub>	Junction-to-case (top) thermal resistance	43.3	56.0	°C/W
R <sub>θJB</sub>	Junction-to-board thermal resistance	43.5	23.4	°C/W
ψ <sub>JT</sub>	Junction-to-top characterization parameter	7.7	1.6	°C/W
ψ <sub>JB</sub>	Junction-to-board characterization parameter	43.1	23.4	°C/W
R <sub>θJC(bottom)</sub>	Junction-to-case (bottom) thermal resistance	N/A	8.2	°C/W

(1) For more information about traditional and new thermal metrics, see the [Semiconductor and IC Package Thermal Metrics](#) application report.

## 5.5 Electrical Characteristics Low Noise Amplifier (LNA)

at T<sub>A</sub> = 25°C, VCC = 3.3V to 5V, LNA\_Out = 1kΩ to AGND, R<sub>SOURCE</sub> = 50Ω, and input ac coupling capacitor (C<sub>IN</sub>) = 10nF (unless otherwise noted)

PARAMETER		TEST CONDITIONS	MIN	TYP	MAX	UNIT
<b>DC PERFORMANCE</b>						
G <sub>LNA</sub>	Internal gain			11		V/V
	Internal gain error	T <sub>A</sub> = -40°C to +125°C		±0.8	±1	%
<b>AC PERFORMANCE</b>						
SSBW	Small-signal bandwidth	LNA_Out = 20mV <sub>PP</sub>		39		MHz
LSBW	Large-signal bandwidth			36		MHz
SR	Slew rate	2V step at LNA_Out		200		V/μs
	Total input referred noise	f > 100kHz, includes gain and bias resistors		2.6		nV/√Hz
	Overdrive recovery time	2 × output overdrive		1		μs
	Capacitive drive <sup>(1)</sup>	< 3dB of peaking		∞		nF
<b>INPUT</b>						
V <sub>LNA_In</sub>	Linear input voltage	VCC = 5V			200	mV <sub>P</sub>
		VCC = 3.3V			140	
V <sub>BIAS</sub>	Internal bias voltage	At LNA_In, T <sub>A</sub> = -40°C to +125°C		VCC × 0.044		mV
	Input impedance of LNA			1.7    1.8		kΩ    pF
<b>OUTPUT</b>						
	Output bias point of LNA	LNA_In = open		V <sub>BIAS</sub> × 11		V
	Output impedance of LNA		0.850	1	1.150	kΩ
<b>POWER SUPPLY</b>						
	Quiescent operating current	LNA_Out = Open		2	2.7	mA
		T <sub>A</sub> = -40°C to +125°C				
<b>POWER DOWN</b>						
	LNA enable voltage threshold		VCC - 1.2			V
	LNA disable voltage threshold			GND + 0.6		V
	Turn-on time	Time from disable to enable		50		μs
	Turn off time	Time from enable to disable		130		ns

(1) Infinite capacitive drive possible due to presence of 1kΩ of isolation resistor.

## 5.6 Electrical Characteristics Log Detector

at  $T_A = 25^\circ\text{C}$ ,  $V_{CC} = 3.3\text{V}$  to  $5\text{V}$ ,  $C_F = 1\text{nF}$ ,  $R_F = 43\text{k}\Omega$  (slope =  $43\text{mV/dB}$ ) for  $V_{CC} = 5\text{V}$  and  $R_F = 30\text{k}\Omega$  for  $V_{CC} = 3.3\text{V}$ ,  $\text{Ref\_resistor} = 1\%$   $56\text{k}\Omega$ ,  $10\text{nF}$  capacitor to AGND or to source on  $\text{Log\_inp}$  and  $\text{Log\_inm}$  (unless otherwise noted)<sup>(1) (2)</sup>

PARAMETER		TEST CONDITIONS		MIN	TYP	MAX	UNIT	
<b>AC PERFORMANCE</b>								
LCE	Log conformance error <sup>(3)</sup>	f = 1MHz			$\pm 0.6$	$\pm 1$	dB	
			$T_A = -40^\circ\text{C}$ to $+125^\circ\text{C}$					$\pm 1.1$
		f = 40MHz			$\pm 2$			
			$T_A = -40^\circ\text{C}$ to $+125^\circ\text{C}$			$\pm 2.5$		
DR	Dynamic range <sup>(3)</sup>	LCE = $\pm 1\text{dB}$ , f = 1MHz, $V_{CC} = 5\text{V}$		96	98		dB	
	Log Detector slope <sup>(4)</sup>			$R_F$ value in $\text{k}\Omega$ <sup>(5)</sup>			mV/dB	
	Log Detector slope variation <sup>(3)</sup>	Ref_Res = $56\text{k}\Omega$ , f = 1MHz			$\pm 1$	$\pm 6$	%	
			$T_A = -40^\circ\text{C}$ to $+125^\circ\text{C}$					$\pm 6.8$
		Ref_Res = open, f = 1MHz			$\pm 4.5$			
			$T_A = -40^\circ\text{C}$ to $+125^\circ\text{C}$			$\pm 5.6$		
<b>INPUT</b>								
$V_{\text{Log\_In}}$	Typical input range	$V_{CC} = 3.3\text{V}$ , LCE = $\pm 2\text{dB}$ , f = 20MHz			$20\mu$	1.2	$V_P$	
			$T_A = -40^\circ\text{C}$ to $+85^\circ\text{C}$			$24\mu$		1
			$T_A = -40^\circ\text{C}$ to $+125^\circ\text{C}$			$26\mu$		0.8
		$V_{CC} = 5\text{V}$ , LCE = $\pm 2\text{dB}$ , f = 20MHz			$20\mu$	1.6		
			$T_A = -40^\circ\text{C}$ to $+85^\circ\text{C}$			$22\mu$		1.6
			$T_A = -40^\circ\text{C}$ to $+125^\circ\text{C}$			$32\mu$		1.6
	Differential input voltage	$(\text{Log\_Inp}) - (\text{Log\_Inm})$ , $T_A = -40^\circ\text{C}$ to $+125^\circ\text{C}$				$\pm 1.6$	V	
	Internal bias voltage	Log_Inp and Log_Inm			1.7		V	
	Input impedance	for Log_Inp and Log_Inm			$1.7 \parallel 10$		$\text{k}\Omega \parallel \text{pF}$	
<b>LOG_OUT</b>								
	Log_Out rise time	$C_F = 220\text{pF}$			20		$\mu\text{s}$	
		$C_F = 1\text{nF}$			95			
	Log_Out fall time	$C_F = 220\text{pF}$			27		$\mu\text{s}$	
		$C_F = 1\text{nF}$			100			
	Output overdrive recovery	$C_F = 220\text{pF}$			250		$\mu\text{s}$	
	Minimum output voltage <sup>(3) (6)</sup> Log_Inp = $10\text{nF}$ to AGND	QFN Package		82	142	233	mV	
			$T_A = -40^\circ\text{C}$ to $+125^\circ\text{C}$					301
		SOIC Package		90	130	162	mV	
			$T_A = -40^\circ\text{C}$ to $+125^\circ\text{C}$					250
	Maximum output voltage	$T_A = -40^\circ\text{C}$ to $+125^\circ\text{C}$		$V_{CC} - 0.3$			V	

## 5.6 Electrical Characteristics Log Detector (continued)

at  $T_A = 25^\circ\text{C}$ ,  $V_{CC} = 3.3\text{V}$  to  $5\text{V}$ ,  $C_F = 1\text{nF}$ ,  $R_F = 43\text{k}\Omega$  (slope =  $43\text{mV/dB}$ ) for  $V_{CC} = 5\text{V}$  and  $R_F = 30\text{k}\Omega$  for  $V_{CC} = 3.3\text{V}$ , Ref\_resistor =  $1\%$   $56\text{k}\Omega$ ,  $10\text{nF}$  capacitor to AGND or to source on Log\_inp and Log\_inm (unless otherwise noted)<sup>(1) (2)</sup>

PARAMETER	TEST CONDITIONS	MIN	TYP	MAX	UNIT
<b>BUFFER OUTPUT (<math>C_{LOAD} \parallel R_{LOAD} = 100\text{pF} \parallel 10\text{k}\Omega</math>)</b>					
Gain	$V_{Buffer}/V_{Log\_Out}$		+2		V/V
Output voltage equation			$2 \times$ Log_Out		V
Output-referred offset				30	mV
Output voltage	$T_A = -40^\circ\text{C}$ to $+125^\circ\text{C}$	GND + 0.1		$V_{CC} - 0.1$	V
Rise-and-fall time <sup>(5)</sup>	$C_{LOAD} \parallel R_{LOAD} = 100\text{pF} \parallel 10\text{k}\Omega$		1.5		$\mu\text{s}$
Short-circuit current	Source-and-sink current	10			mA
$Z_{OUT}$	Output impedance		5.3		$\Omega$
<b>INV_BUFFER OUTPUT (<math>C_{LOAD} \parallel R_{LOAD} = 100\text{pF} \parallel 10\text{k}\Omega</math>)</b>					
Gain	$V_{Inv\_Buffer}/V_{Log\_Out}$		-2		V/V
Output voltage equation			$V_{CC} -$ ( $2 \times$ Log_Out)		V
Output voltage	$T_A = -40^\circ\text{C}$ to $+125^\circ\text{C}$	GND + 0.1		$V_{CC} - 0.1$	V
Rise-and-fall time <sup>(5)</sup>	$C_{LOAD} \parallel R_{LOAD} = 100\text{pF} \parallel 10\text{k}\Omega$		1.5		$\mu\text{s}$
Output-referred offset				32	mV
Short-circuit current	Source-and-sink current	10			mA
Output impedance			6.3		$\Omega$
<b>FREQUENCY DETECT OUTPUT</b>					
Frequency detect block typical input sensitivity	Log_Inp signal of $f < 20\text{MHz}$	250 $\mu$		1.6	$V_P$
Frequency error	Averaged over 1ms, $T_A = -40^\circ\text{C}$ to $+125^\circ\text{C}$		0.15		%
Freq_Out swing		DGND		Freq_Supply	V
<b>POWER SUPPLY</b>					
Quiescent current	Current through VCC		3.6	4.6	mA
		$T_A = -40^\circ\text{C}$ to $+125^\circ\text{C}$		5.9	
	Current through Freq_Supply			0.37	

- (1) See [Offset Correction Loop](#) to calculate the value of capacitor on Offset\_Cap pin based on signal frequency.
- (2) The symbol f stands for a short burst of sine wave applied at the Log\_Inp pin. This definition applies across the data sheet.
- (3) Characterized through 32 units.
- (4) Log-Detector slope reduces with increased input signal frequency, see [Typical Characteristics](#).
- (5) See [Parameter Measurement Information](#) for definition of  $R_F$ .
- (6) Minimum output voltage is the lowest voltage that Log\_Out settles to when the inputs are shorted to the AGND pin using a high-value capacitor with no signal applied.

## 5.7 Electrical Characteristics LNA + Log Detector (AFE)

at  $T_A = 25^\circ\text{C}$ ,  $V_{CC} = 5\text{V}$ ,  $C_F = 1\text{nF}$  and  $R_F = 43\text{k}\Omega$  (slope =  $43\text{mV/dB}$  for  $f = 1\text{MHz}$ ), Ref\_resistor = 1%  $56\text{k}\Omega$ , with 2nd-order external band-pass filter (BPF) of gain =  $-7\text{dB}$ , and  $R_{SOURCE} = 50\Omega$ ,  $10\text{nF}$  capacitor to AGND or to source on LNA\_In (unless otherwise noted)

PARAMETER		TEST CONDITIONS		MIN	TYP	MAX	UNIT
<b>AFE AC PERFORMANCE</b>							
LCE	Log conformance error	$f = 1\text{MHz}$			$\pm 1$		dB
			$T_A = -40^\circ\text{C}$ to $+125^\circ\text{C}$		$\pm 1$		
DR	Dynamic range	For LCE = $\pm 1\text{dB}$ , $f = 1\text{MHz}$			91		dB
	Log Detector slope variation <sup>(1)</sup>	Ref_Res = open			$\pm 4.5$		%
		Ref_Res = $56\text{k}\Omega$			$\pm 1$	$\pm 7$	
		Ref_Res = $56\text{k}\Omega$	$T_A = -40^\circ\text{C}$ to $+125^\circ\text{C}$			$\pm 7.2$	
<b>AFE INPUT</b>							
	Typical input voltage	LCE = $\pm 1\text{dB}$ , $f = 1\text{MHz}$		$7\mu$	$200\text{m}$	V <sub>P</sub>	
			$T_A = -40^\circ\text{C}$ to $+125^\circ\text{C}$	$8\mu$	$200\text{m}$		
		LCE = $\pm 2\text{dB}$ , $f = 20\text{MHz}$		$12\mu$	$200\text{m}$		
			$T_A = -40^\circ\text{C}$ to $+125^\circ\text{C}$	$14\mu$	$200\text{m}$		
Output rise time	BPF = $180\text{kHz}$ , $C_F = 350\text{pF}$			35	$\mu\text{s}$		
	BPF = $1\text{MHz}$ , $C_F = 500\text{pF}$			50			
Output fall time	BPF = $180\text{kHz}$ , $C_F = 350\text{pF}$			65	$\mu\text{s}$		
	BPF = $1\text{MHz}$ , $C_F = 500\text{pF}$			45			
<b>LOG_OUT</b>							
	Minimum output voltage <sup>(1)</sup>	LNA_In = $10\text{nF}$ to AGND		290	335	mV	
			$T_A = -40^\circ\text{C}$ to $+125^\circ\text{C}$		450		
<b>POWER SUPPLY</b>							
	VCC quiescent current	Total AFE, LNA_Out = open		6	7.2	mA	
			$T_A = -40^\circ\text{C}$ to $+125^\circ\text{C}$		8.3		
<b>POWER DOWN</b>							
	VCC disabled current	Total AFE, VCC = $3.3\text{V}$	$T_A = -40^\circ\text{C}$ to $+125^\circ\text{C}$	65		$\mu\text{A}$	
		Total AFE, VCC = $5\text{V}$		130			
	AFE enable voltage threshold			VCC– 1.2		V	
	AFE disable voltage threshold			AGND + 0.6		V	

(1) Characterized through 32 devices.



### 5.8 Typical Characteristics: VCC = 5V

at  $T_A = 25^\circ\text{C}$ ,  $V_{CC} = 5\text{V}$ ,  $C_F = 1\text{nF}$ ,  $R_F = 43\text{k}\Omega$  (slope =  $43\text{mV/dB}$ ),  $\text{Ref\_Res} = 1\%$   $56\text{k}\Omega$ , and  $10\text{nF}$  capacitor to AGND on  $\text{Log\_Inp}$  and  $\text{Log\_Inm}$  (unless otherwise noted); for AFE, 2nd-order BPF centered around frequency  $f$  with gain =  $-7\text{dB}$  used between LNA and Log Detector block

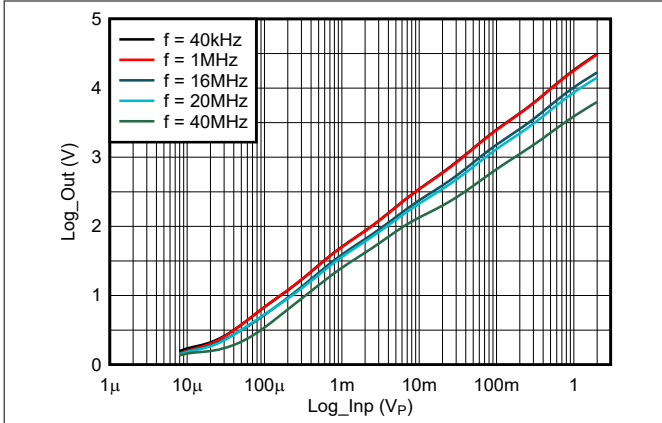

Figure 5-1. Log-Detector Output at Various Frequencies

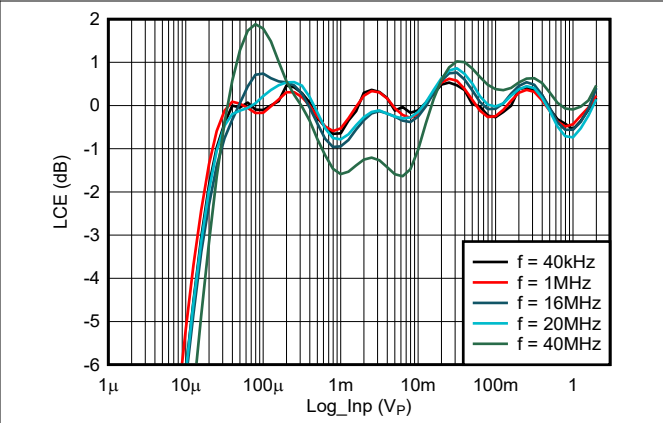

Figure 5-2. Log-Detector Conformance Error for Different Frequencies

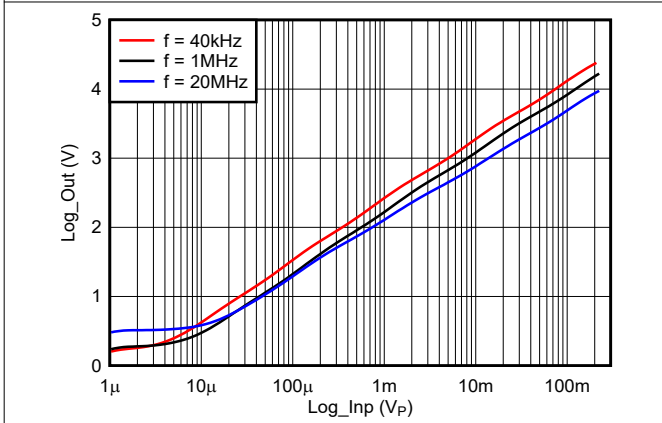

Figure 5-3. AFE Output at Various Frequencies

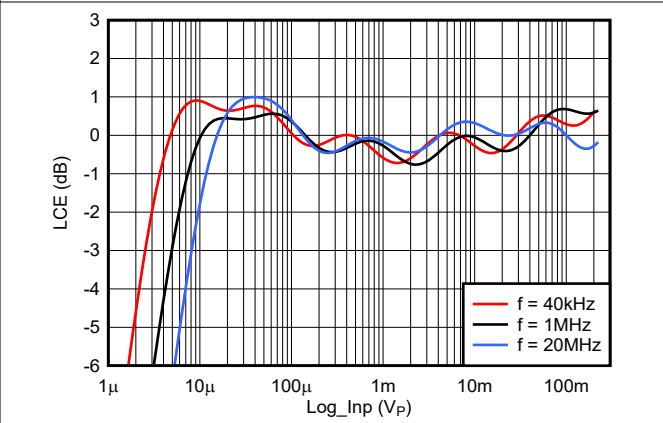

Figure 5-4. AFE Log-Conformance Error for Different Frequencies

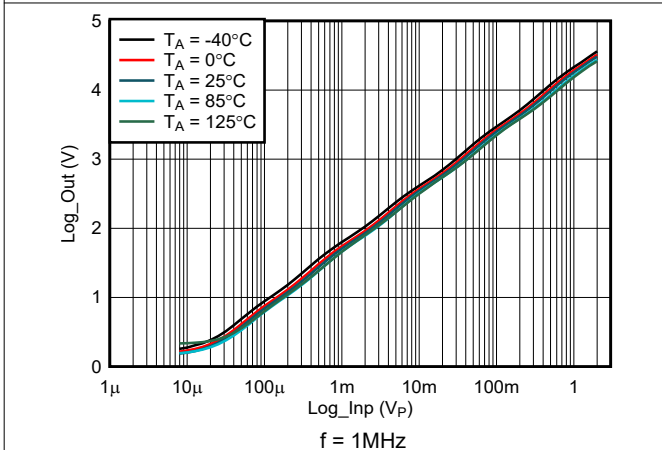

Figure 5-5. Log-Detector Output at Different Temperature Points

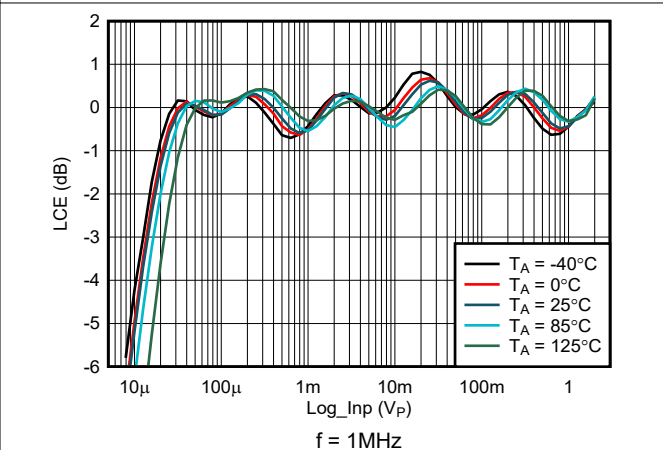

Figure 5-6. Log-Detector Conformance Error for Different Temperature Points

### 5.8 Typical Characteristics: VCC = 5V (continued)

at  $T_A = 25^\circ\text{C}$ ,  $V_{CC} = 5\text{V}$ ,  $C_F = 1\text{nF}$ ,  $R_F = 43\text{k}\Omega$  (slope =  $43\text{mV/dB}$ ),  $\text{Ref\_Res} = 1\%$   $56\text{k}\Omega$ , and  $10\text{nF}$  capacitor to AGND on  $\text{Log\_Inp}$  and  $\text{Log\_Inm}$  (unless otherwise noted); for AFE, 2nd-order BPF centered around frequency  $f$  with gain =  $-7\text{dB}$  used between LNA and Log Detector block

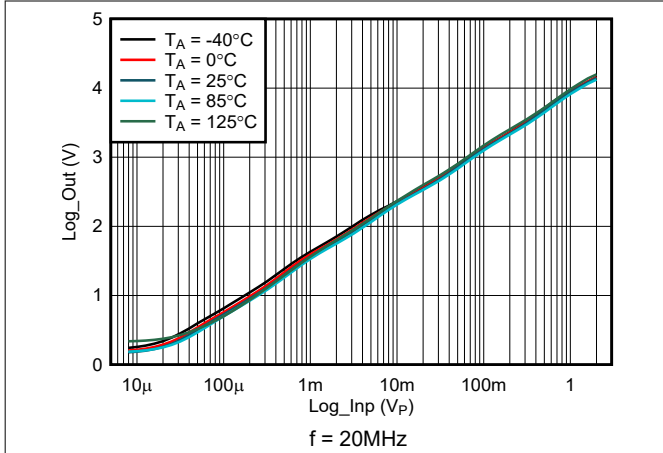

Figure 5-7. Log-Detector Output at Different Temperature Points

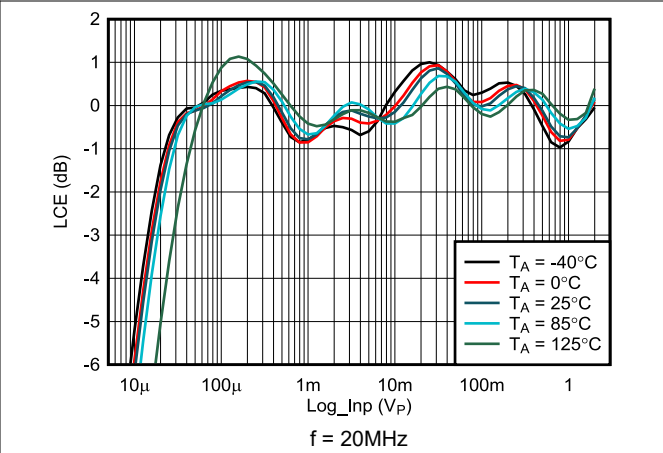

Figure 5-8. Log-Detector Conformance Error for Different Temperature Points

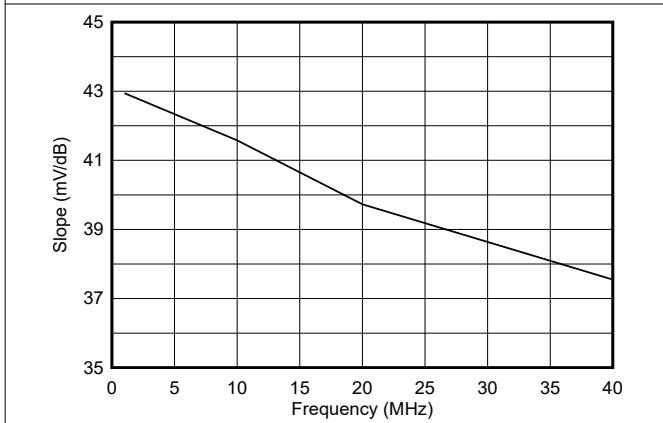

Figure 5-9. Log-Detector Slope Variation with Input Signal Frequency

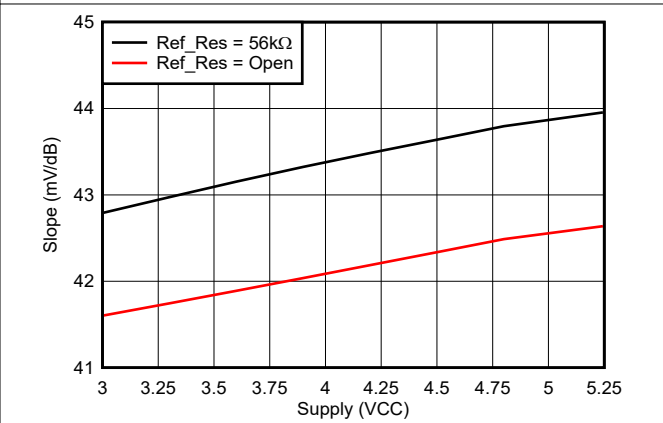

Figure 5-10. Log-Detector Slope Variation vs Supply

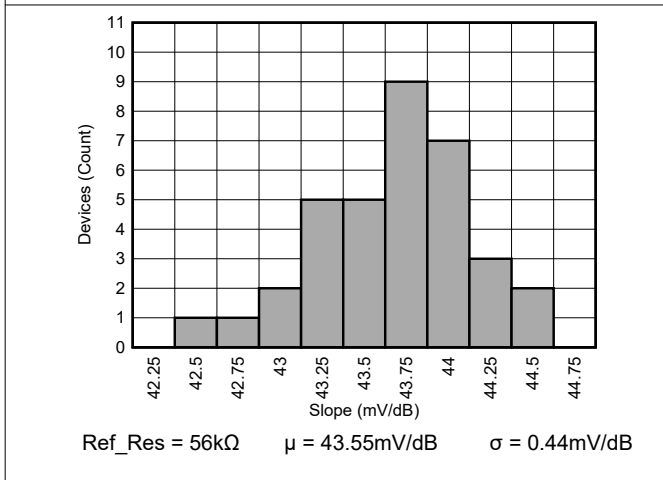

Figure 5-11. Log-Detector Slope Histogram With Ref\_Res

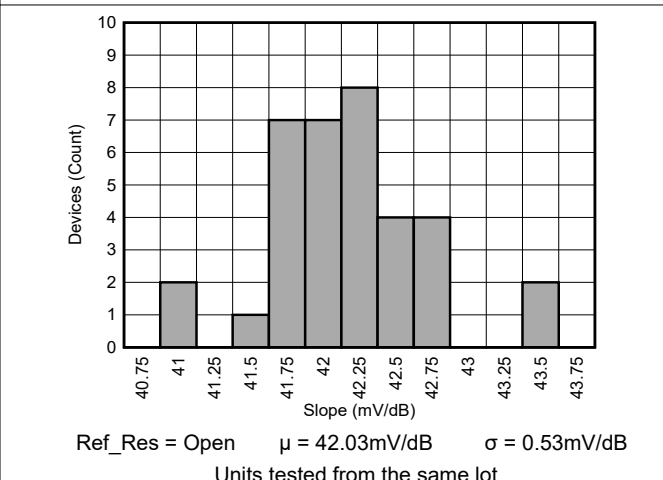
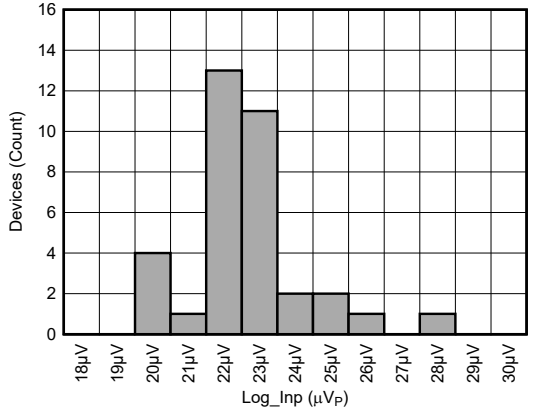

Figure 5-12. Log-Detector Slope Histogram Without Ref\_Res

### 5.8 Typical Characteristics: VCC = 5V (continued)

at  $T_A = 25^\circ\text{C}$ ,  $V_{CC} = 5\text{V}$ ,  $C_F = 1\text{nF}$ ,  $R_F = 43\text{k}\Omega$  (slope =  $43\text{mV/dB}$ ),  $\text{Ref\_Res} = 1\%$   $56\text{k}\Omega$ , and  $10\text{nF}$  capacitor to AGND on  $\text{Log\_Inp}$  and  $\text{Log\_Inm}$  (unless otherwise noted); for AFE, 2nd-order BPF centered around frequency  $f$  with gain =  $-7\text{dB}$  used between LNA and Log Detector block



LCE =  $\pm 1\text{dB}$ ,  $\mu = 22.15\mu\text{V}_P$   $\sigma = 1.59\mu\text{V}_P$   
f = 1MHz

**Figure 5-13. Minimum Input Sensitivity of Log\_Detector**

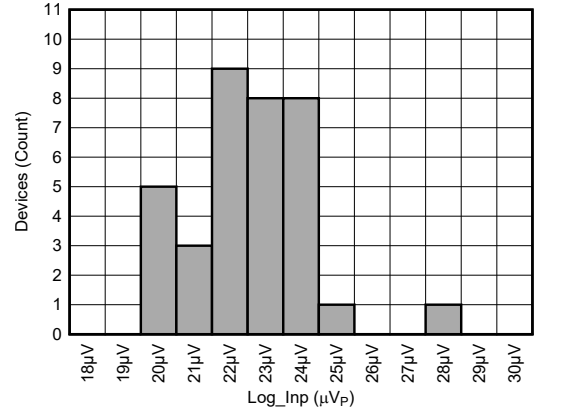

LCE =  $\pm 2\text{dB}$ ,  $\mu = 22.14\mu\text{V}_P$   $\sigma = 1.67\mu\text{V}_P$   
f = 20MHz

**Figure 5-14. Minimum Input Sensitivity of Log\_Detector**

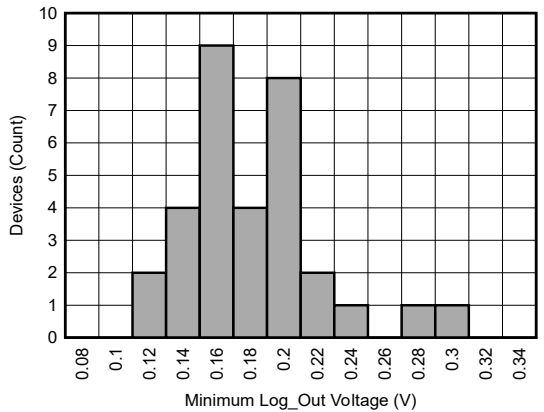

50Ω + 10nF at  $\mu = 0.17\text{V}$   $\sigma = 0.04\text{V}$   
Log\_Inp to AGND

**Figure 5-15. Minimum Output Voltage at Log\_Out**

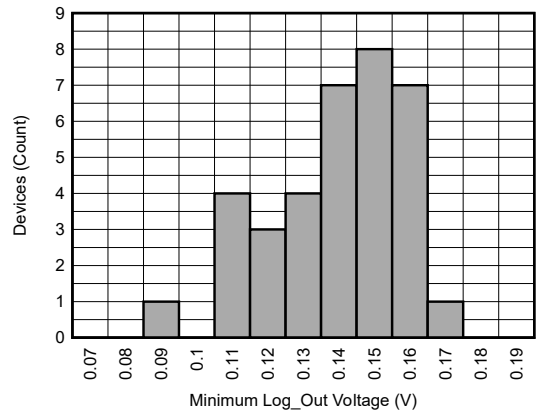

10nF at Log\_Inp to  $\mu = 0.13\text{V}$   $\sigma = 0.018\text{V}$   
AGND

**Figure 5-16. Minimum Output Voltage at Log\_Out**

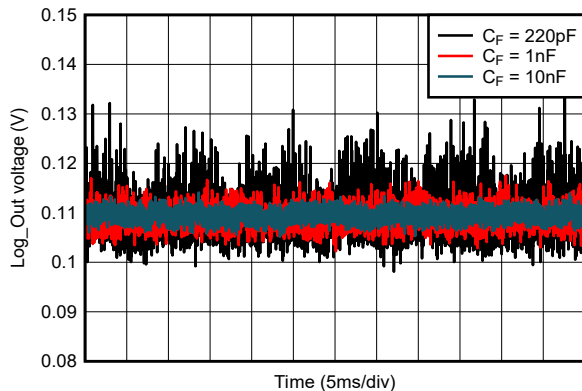

**Figure 5-17. Minimum Log\_Out Voltage vs Time**

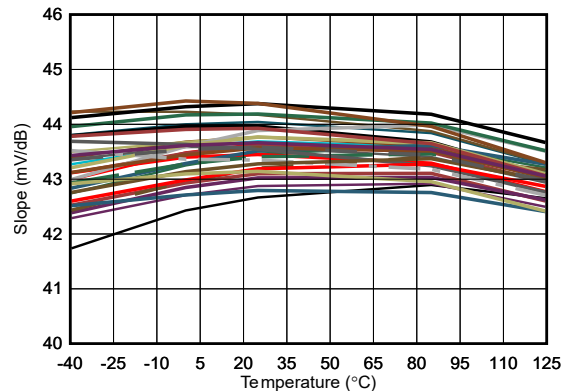

**Figure 5-18. Slope Variation vs Temperature**

### 5.8 Typical Characteristics: VCC = 5V (continued)

at  $T_A = 25^\circ\text{C}$ ,  $V_{CC} = 5\text{V}$ ,  $C_F = 1\text{nF}$ ,  $R_F = 43\text{k}\Omega$  (slope =  $43\text{mV/dB}$ ),  $\text{Ref\_Res} = 1\%$   $56\text{k}\Omega$ , and  $10\text{nF}$  capacitor to AGND on  $\text{Log\_Inp}$  and  $\text{Log\_Inm}$  (unless otherwise noted); for AFE, 2nd-order BPF centered around frequency  $f$  with gain =  $-7\text{dB}$  used between LNA and Log Detector block

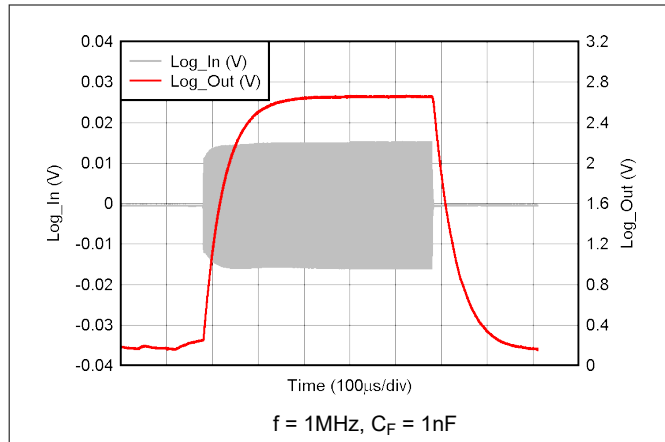

Figure 5-19. Log-Detector Rise and Fall Time

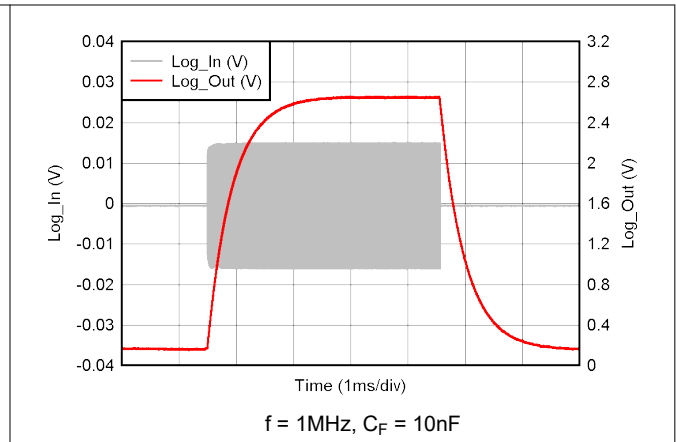

Figure 5-20. Log-Detector Rise and Fall Time

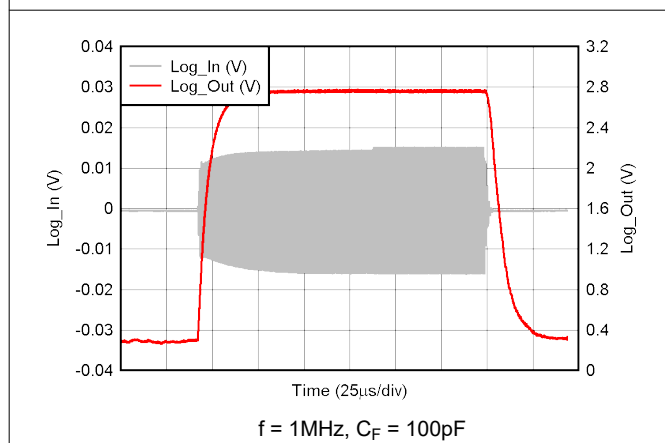

Figure 5-21. Log-Detector Rise and Fall Time

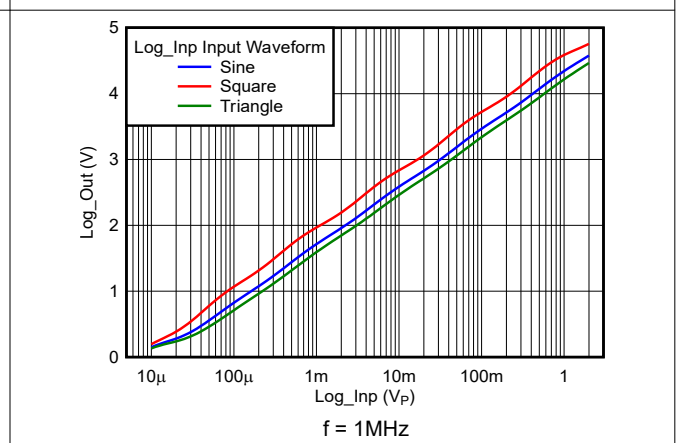

Figure 5-22. Log-Detector output for Various Input Waveforms

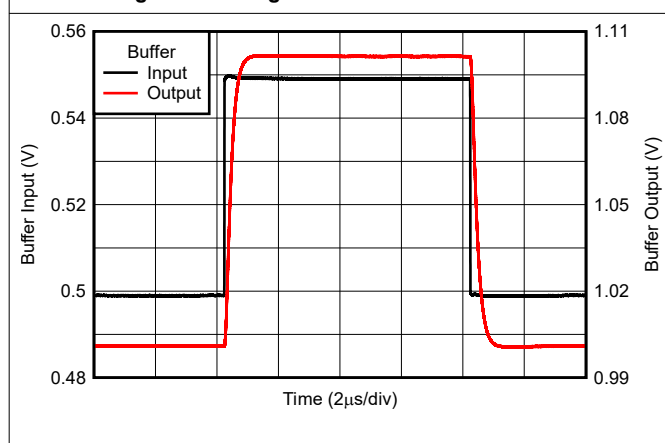

Figure 5-23. Small-Signal Step Response: Buffer

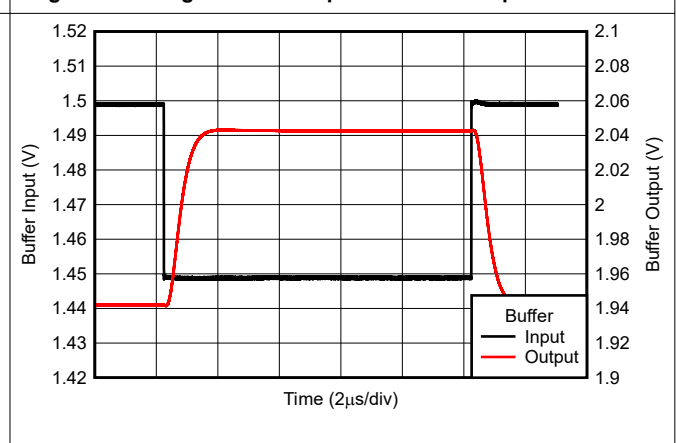

Figure 5-24. Small-Signal Step Response: Inverting Buffer

### 5.8 Typical Characteristics: VCC = 5V (continued)

at  $T_A = 25^\circ\text{C}$ ,  $V_{CC} = 5\text{V}$ ,  $C_F = 1\text{nF}$ ,  $R_F = 43\text{k}\Omega$  (slope =  $43\text{mV/dB}$ ),  $\text{Ref\_Res} = 1\%$   $56\text{k}\Omega$ , and  $10\text{nF}$  capacitor to AGND on  $\text{Log\_Inp}$  and  $\text{Log\_Inm}$  (unless otherwise noted); for AFE, 2nd-order BPF centered around frequency  $f$  with gain =  $-7\text{dB}$  used between LNA and Log Detector block

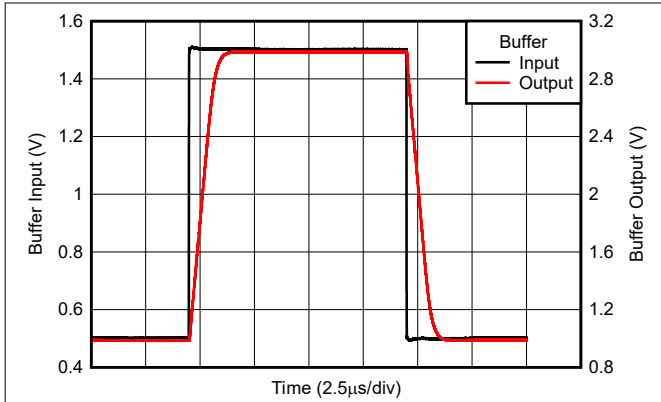

Figure 5-25. Large-Signal Step Response: Buffer

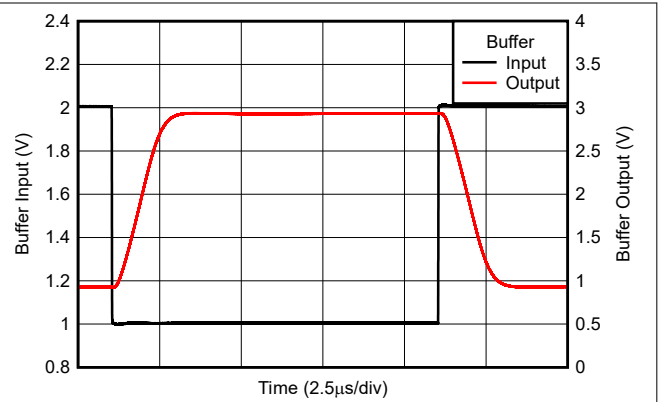

Figure 5-26. Large-Signal Step Response: Inverting Buffer

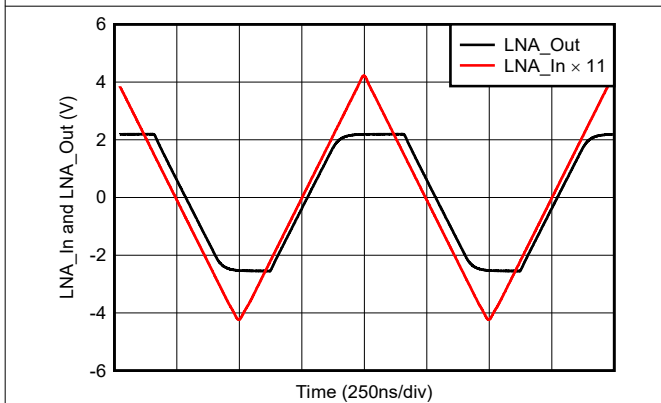

Figure 5-27. LNA Overdrive Recovery

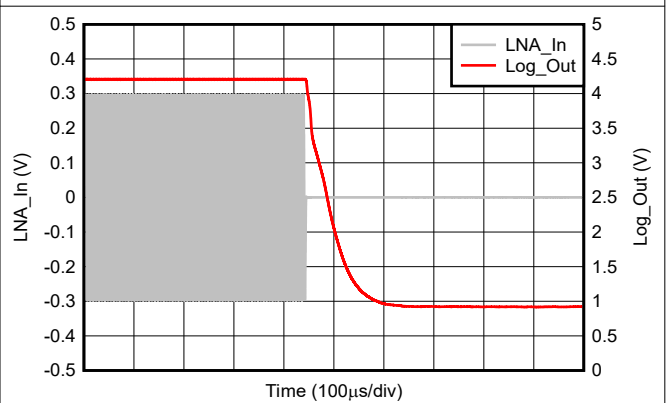

Figure 5-28. AFE Overdrive Recovery

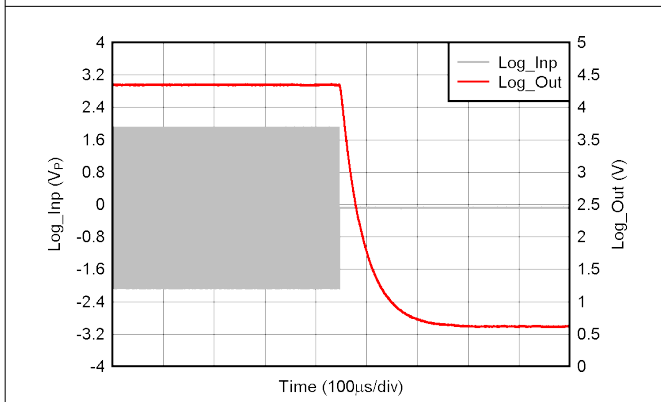

Figure 5-29. Log-Detector Input Stage Overdrive

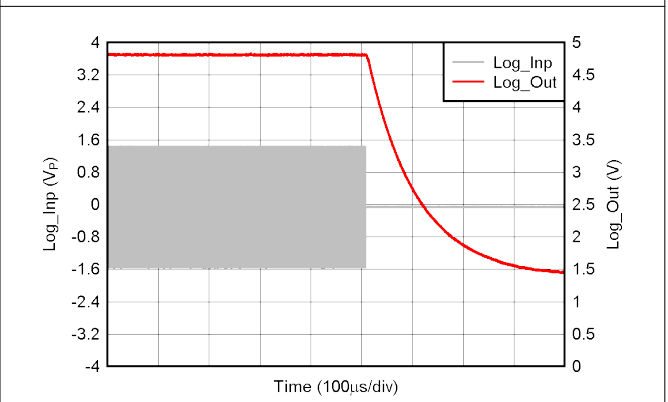

Figure 5-30. Log-Detector Output Stage Overdrive

### 5.8 Typical Characteristics: VCC = 5V (continued)

at  $T_A = 25^\circ\text{C}$ ,  $V_{CC} = 5\text{V}$ ,  $C_F = 1\text{nF}$ ,  $R_F = 43\text{k}\Omega$  (slope =  $43\text{mV/dB}$ ),  $\text{Ref\_Res} = 1\%$   $56\text{k}\Omega$ , and  $10\text{nF}$  capacitor to AGND on  $\text{Log\_Inp}$  and  $\text{Log\_Inm}$  (unless otherwise noted); for AFE, 2nd-order BPF centered around frequency  $f$  with gain =  $-7\text{dB}$  used between LNA and Log Detector block

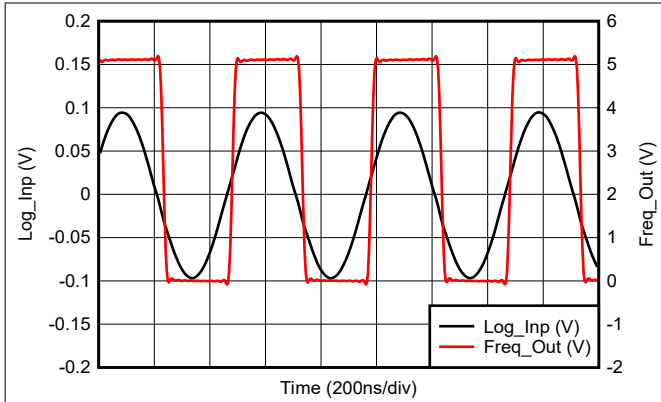
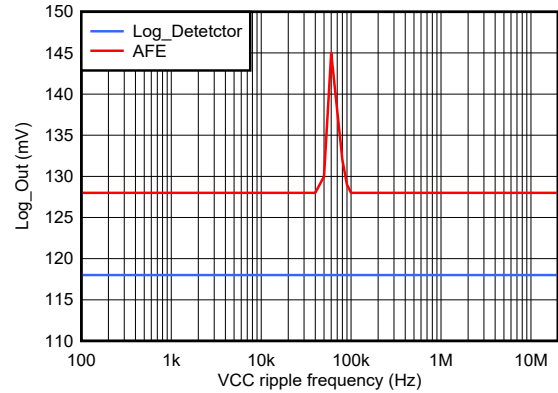
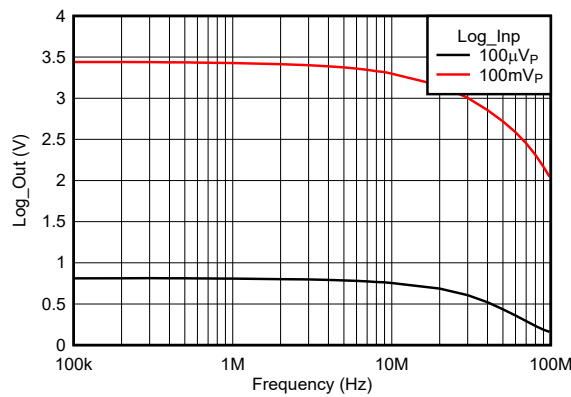

Figure 5-31. Frequency Detector Output Waveform



AFE; BPF =  $65\text{kHz}$ , RC filter on VCC of  $R = 50\Omega$ ,  $C = 12\mu\text{F}$   
Figure 5-32. Output vs 100mVpp Ripple Injected on VCC



$R_F = 42.2\text{k}\Omega$ ,  $\text{Offset\_Cap} = 100\text{nF}$   
Figure 5-33. Slope vs Frequency

### 5.9 Typical Characteristics: VCC = 3.3V

at  $T_A = 25^\circ\text{C}$ ,  $V_{CC} = 3.3\text{V}$ ,  $C_F = 1\text{nF}$ ,  $R_F = 30\text{k}\Omega$  (slope =  $30\text{mV/dB}$ ),  $\text{Ref\_Res} = 1\%$   $56\text{k}\Omega$ , and  $10\text{nF}$  capacitor to AGND on  $\text{Log\_Inp}$  and  $\text{Log\_Inm}$  (unless otherwise noted); for AFE, 2nd-order BPF centered around frequency  $f$  with gain =  $-7\text{dB}$  used between LNA and Log Detector block

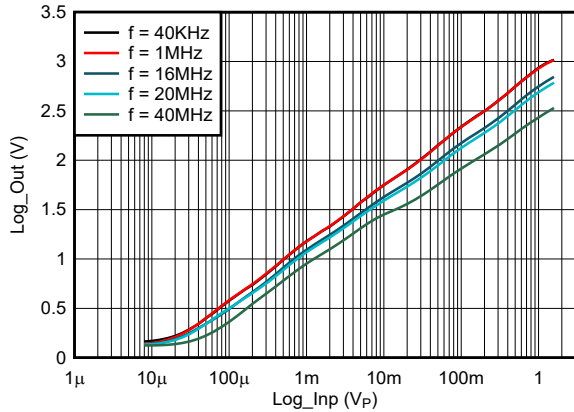

Figure 5-34. Log-Detector Output at Various Frequencies

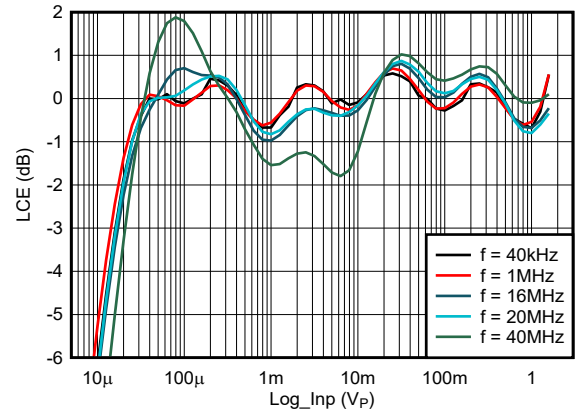

Figure 5-35. Log-Detector Conformance Error for Different Frequencies

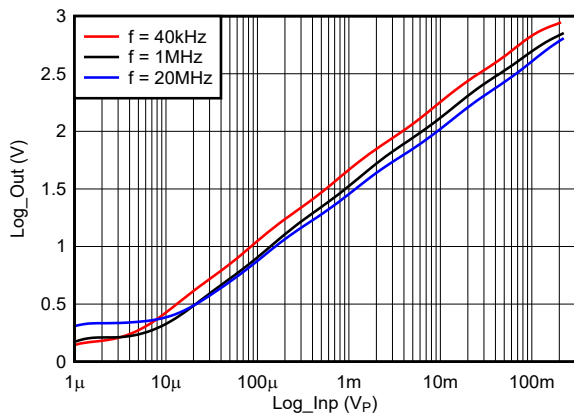

Figure 5-36. AFE Output at Various Frequencies

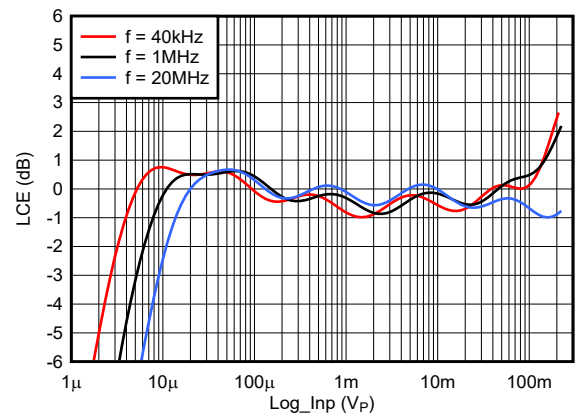

Figure 5-37. AFE Log-Conformance Error for Different Frequencies

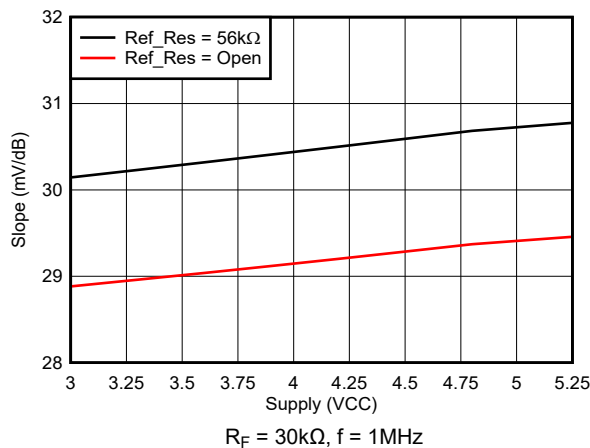

Figure 5-38. Log-Detector Slope Variation vs Supply

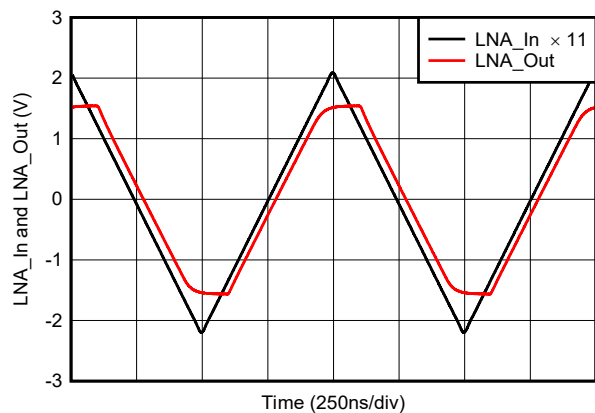

Figure 5-39. LNA Overdrive Recovery

## 6 Parameter Measurement Information

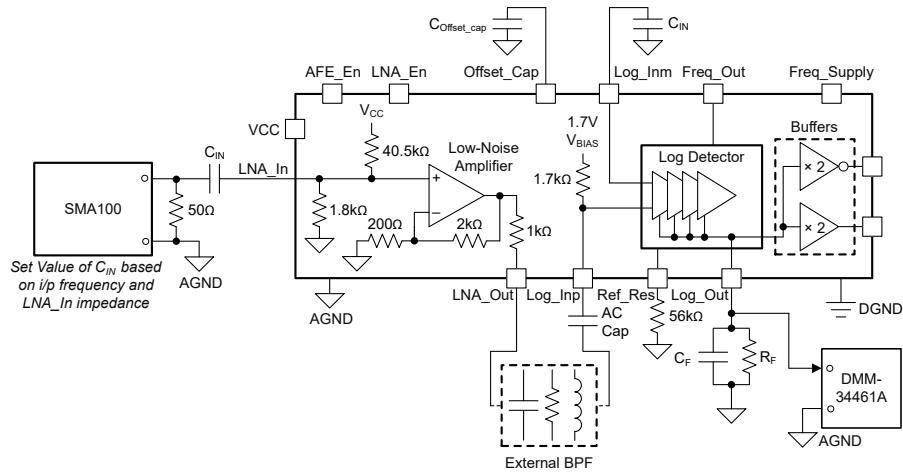

Figure 6-1. AFE (LNA + Log Detector) Slope Characterization

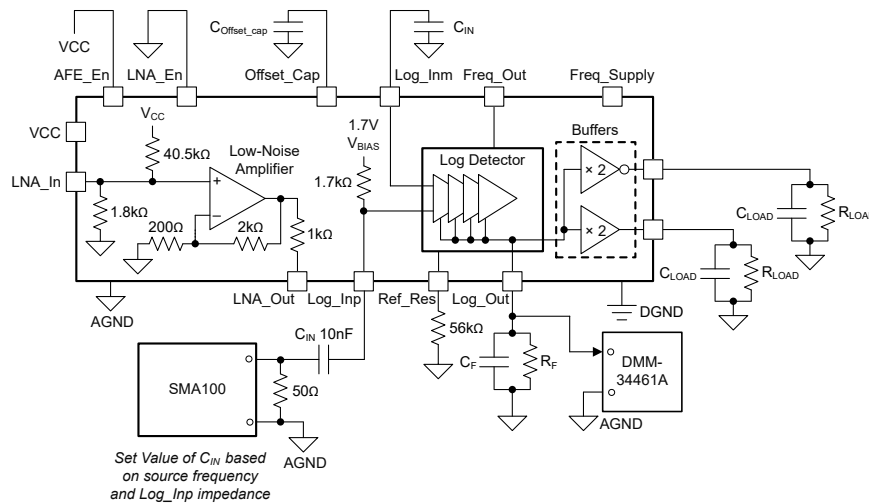

Figure 6-2. Log Detector Slope Characterization

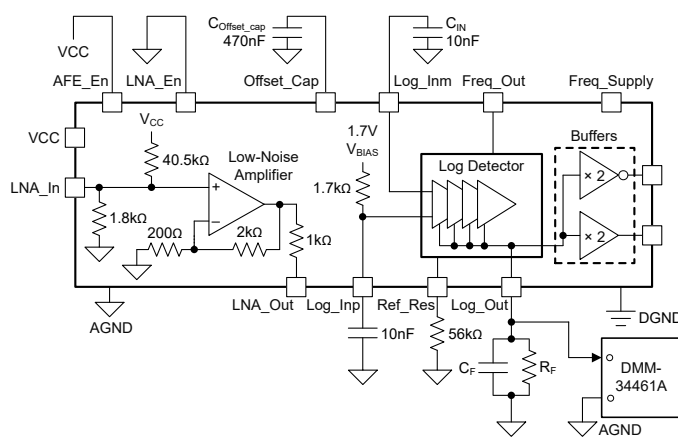

Figure 6-3. Log Detector Minimum Output Voltage Measurement



## 7 Detailed Description

### 7.1 Overview

The LOG300 is a highly sensitive analog front-end system for power measurements of up to 40MHz signals with a typical dynamic range of 98dB. The LOG300 is intended for use in a wide variety of applications like ultrasonic Rx signal chains, amplitude demodulation, signal power measurement, grid monitoring and so on. The LOG300 provides an analog envelope of an amplitude proportional to the log of the input signal. This behavior provides the application circuit precise input signal amplitude measurement without the need of high-speed signal acquisition components. The integrated frequency-detect feature enables zero-crossing and frequency measuring capability of the incoming signal.

### 7.2 Functional Block Diagram

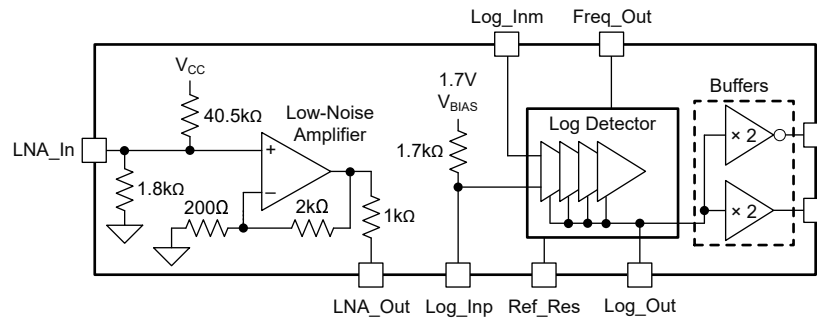

### 7.3 Feature Description

#### 7.3.1 Offset Correction Loop (OCL)

The LOG300 comes with an internal offset correction loop (OCL) designed to correct for any small offset voltage errors due to external factors or due to the internal gain mismatch. The LOG300 internal gain blocks offer very high gain; therefore, any small error voltage is sufficient to saturate the respective gain block resulting in degradation of dynamic range.

The Offset\_Cap (see [Section 6](#)) sets the time constant of the offset correction loop. Set the value of the OCL pole to less than the incoming signal frequency so that the OCL does not respond to the incoming signal. Use the following formula to calculate the value of Offset\_Cap based on the frequency of the incoming signal.

$$C_{Offset\_Cap} (nF) \geq \frac{6000}{Frequency\ of\ input\ signal\ (kHz)} \quad (1)$$

Where

- Offset capacitor must never be less than 1nF. If the formula yields a value of  $C_{Offset\_Cap}$  less than 1nF, use 1nF.
- Using a value of  $C_{Offset\_Cap}$  greater than the calculated value using above equation is acceptable since the OCL loop is set to a lower frequency.

### 7.3.2 Single and Differential Input

The Log Detector block of the LOG300 supports both single-ended and differential input signals. Irrespective of the type of input signal, the impedances from the Log\_Inp and Log\_Inm pins to AGND have to be matched.

The requirement for impedance matching arises from the fact that any supply noise or externally coupled noise passes through these impedances and generates an input voltage. If the impedances are mismatched at the two inputs a differential voltage is seen by the Log Detector block thereby increasing the minimum output voltage at the Log\_Out pin. This results in degradation of the dynamic range.

Impedance matching for differential input case can be easily achieved by replicating source impedance on both pins.

However for single-ended inputs, impedance matching can be quite complex. If board space is not limited TI recommends to copy the input structure at the Log\_Inp pin as, is on to the Log\_Inm input. Please take note of the default internal output impedance of the LNA of  $1k\Omega$  when copying the structure to the Log\_Inm pin.

If the above recommendation is not possible, match the impedances between the two pins at the frequency with the highest probability of noise coupling. For example if the VCC supply is being derived by a DC/DC converter switching at a frequency of 500kHz, using option 1 gives the best impedance matching between Log\_Inp and Log\_Inm. If the VCC ripple is at 100kHz then both option 1 and option 2 result in the same rejection response.

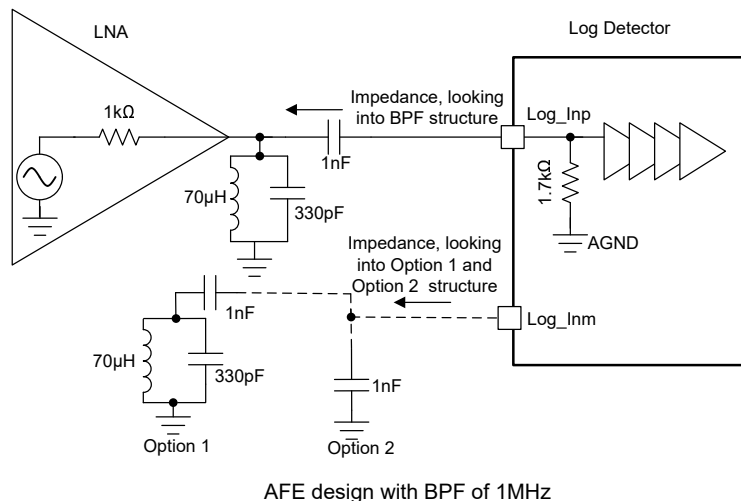

Figure 7-1. Impedance Structure at Log\_Inp and Log\_Inm

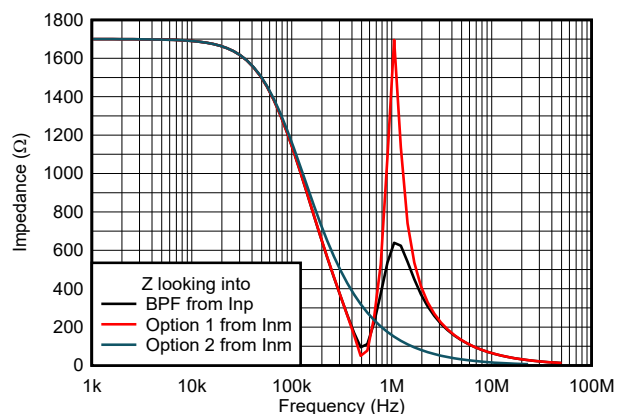

Figure 7-2. Impedance vs Frequency at Log\_Inp and Log\_Inm

### 7.3.3 Input Frequency Detect

The Log\_Out pin creates an envelope proportional to the incoming signal; therefore, the frequency and phase information of the input signal is lost. The frequency detect feature enables the LOG300 to recover this frequency information. The frequency detect pin toggles at the same frequency as the input, and can therefore be used to calculate the input signal frequency or the input signal zero crossing points.

The internal circuit consists of a comparator with one of the inputs connected to the pin Log\_In bias voltage and the other input of the comparator connected to the last stage of the Log Detector gain block (see Figure 7-3). Log\_In is ac coupled; therefore, the incoming signal is biased to the internal bias voltage.

The comparator compares the gained Log\_In (both single-ended and differential) signal biased at the internal bias voltage with the DC internal bias voltage, thereby toggling at every instance of a zero crossing. If the incoming signal is not a symmetric waveform or consists of multiple frequency content, the frequency detect feature compares the zero crossings of the incoming signal.

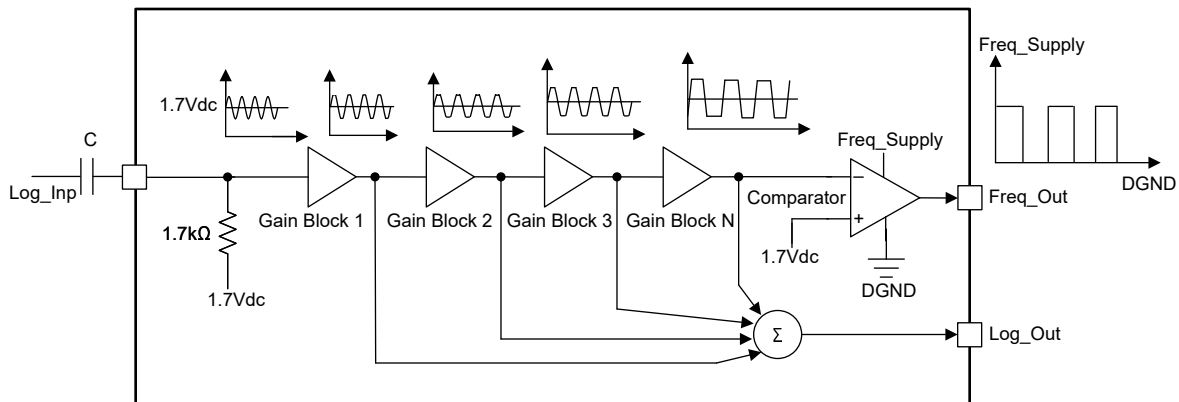

**Figure 7-3. Internal Block Diagram for Frequency Detect**

## 7.4 Device Functional Modes

The LOG300 offers three functional modes:

- AFE Disabled
  - In this mode, the complete AFE (LOG300) is disabled and consumes only about 100μA.
- LNA Disabled
  - In this mode, the LNA is disabled, while the Log Detector block is still operational. See Section 5.6 for detailed parameters in this mode.
  - Typically, this mode is used when the input sensitivity required is relaxed and the application prioritizes a lower quiescent current. Disabling the LNA helps save 2mA of quiescent current originally consumed by the LNA.
- Normal operating mode
  - In this mode, all blocks of the LOG300 are operational. See Section 5.7 for detailed parameters such as power consumption, acceptable supply, and input output range.
  - This mode can be entered by floating the LNA\_En and AFE\_En pins or by tying them to VCC.

## 8 Application and Implementation

### Note

Information in the following applications sections is not part of the TI component specification, and TI does not warrant its accuracy or completeness. TI's customers are responsible for determining suitability of components for their purposes, as well as validating and testing their design implementation to confirm system functionality.

### 8.1 Application Information

The LOG300 is a good fit for multiple applications involving ultrasound receive signal measurement, power, and energy measurements. The wide dynamic range and high input sensitivity makes the LOG300 an excellent option for applications such as the example in [Section 8.2.1](#) involving measurement of low amplitude signals without the need of expensive, high-bandwidth, low-noise components.

### 8.2 Typical Application

#### 8.2.1 Ultrasonic Distance Measurement

This design example demonstrates the circuit calculations and discrete component selection around the LOG300 to achieve a highly sensitive receive signal chain for a typical ultrasonic distance based measurement sensor.

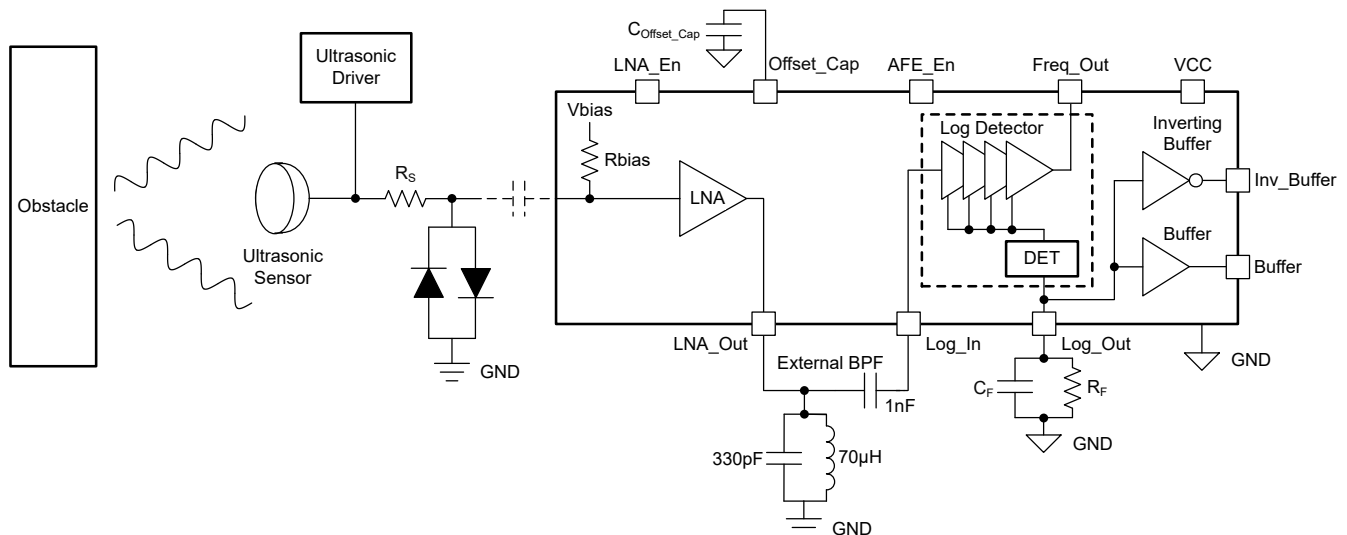

Figure 8-1. Ultrasonic Distance Sensor

#### 8.2.1.1 Design Requirements

Table 8-1. Design Parameters

PARAMETER	VALUE
Supply (VCC)	5V
Minimum input signal measuring capability	7µV <sub>P</sub>
Maximum input signal measuring capability: Linear	200mV <sub>P</sub>
Maximum input signal handling capability (V <sub>max</sub> )	100V <sub>P</sub>
Frequency of Tx and Rx signal	1MHz
Log_Out; Output range	0.5V to 4.5V

### 8.2.1.2 Detailed Design Procedure

The LOG300 supports a 5V VCC. Add a 10Ω and 10μF || 10nF close to the VCC pin to provide sufficient decoupling and immunity from external noise. This supply filter has a pole of 1.59kHz that is sufficiently less than the frequency of interest, which is 1MHz.

The absolute maximum voltage rating of pin LNA\_In is ±1V. Add a back-to-back diode along with a series resistor (R<sub>S</sub>) at the input of the LNA (see also [Figure 8-1](#)). The back-to-back diode protects the LNA\_In pin from being exposed to any high voltages, especially during the transmit operation. Choose the series resistance value in accordance to the maximum power rating (P<sub>MAX</sub>) of the back-to-back diode. The added series resistor contributes to the input noise and deteriorates the minimum input sensitivity.

$$R_S = \frac{(0.7V \times (V_{\max} - 0.7V))}{P_{\max}} \quad (2)$$

The maximum expected output voltage of the LNA with a back-to-back diode placed at the input is:

$$11V/V \times 0.7V_P = 7.7V_P \quad (3)$$

Since the LNA is only powered from a 5V supply; the maximum output is only 2.5V<sub>P</sub>.

The maximum input for the Log\_Inp pin is 1.7V<sub>P</sub> for 5VCC (see also [Section 5.1](#)); therefore, add a band-pass filter (BPF) of appropriate attenuation in the pass-band region so that the detector block absolute maximum voltage rating is not violated. In this particular case, ensure that the BPF has an attenuation of at least -3.3dB. A BPF of -4.3dB is shown in [Figure 8-1](#).

Choose an Offset\_Cap value based on [Section 7.3.1](#).

Choose the value of C<sub>F</sub> based on the required rise time of the Log\_Out pin voltage (V<sub>Log\_Out</sub>). A lower-value C<sub>F</sub> improves the rise time at the cost of higher ripple on the output envelope. For reference plots see also [Section 5.8](#). Connect an oscilloscope at the Log\_Out pin, triggered during the receive burst operation, to find the correct balance between the required rise time and the acceptable ripple.

The R<sub>F</sub> resistor decides the input-to-output slope. The value of R<sub>F</sub> in kΩ equals the input-to-output slope in mV/dB. In this example, calculate R<sub>F</sub> using the below set of equations:

$$\text{Slope (mV/dB)} = R_F \text{ k}\Omega = \frac{(\text{Saturated output voltage} - \text{Minimum output voltage})}{(20 \times \log (\text{Maximum LNA\_In} / \text{Minimum LNA\_In}))} \quad (4)$$

$$\text{Slope (mV/dB)} = R_F \text{ k}\Omega = \frac{(4.5V - 0.5V)}{(20 \times \log (200mV - 7\mu V))} \quad (5)$$

$$\text{Slope (mV/dB)} = 44mV/dB, \text{ hence use } R_F \text{ k}\Omega = 44k\Omega \quad (6)$$

---

#### Note

The maximum and minimum Log\_Out values have been relaxed to design for the output to operate well within the linear range. R<sub>F</sub> accuracy effects the slope accuracy.

---

The voltage measured at Log\_Out can be traced back to calculate the input amplitude using the below equation:

$$\text{Log\_Out}_A = \text{Slope} \times 20 \times \log \left( \frac{\text{Log\_In}_A}{\text{Log\_In}_B} \right) + \text{Log\_Out}_B \quad (7)$$

$$\text{Log\_In}_A = 10 \left( \frac{\text{Log\_Out}_A - \text{Log\_Out}_B}{\text{Slope} \times 20} \right) \times \text{Log\_In}_B \quad (8)$$

Where : A stands for values of Log\_Out and Log\_In at the required measurement point and B stands for Log\_Out and Log\_In values at a known input value measured during factory calibration or production.

### 8.2.1.3 Application Curves

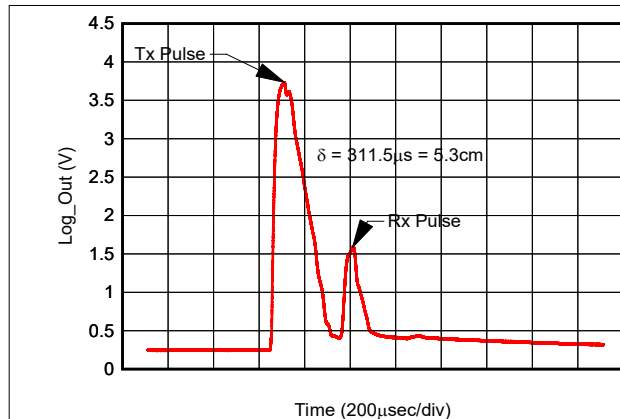

**Figure 8-2. Log\_Out Response for Ultrasonic Distance Measurement**

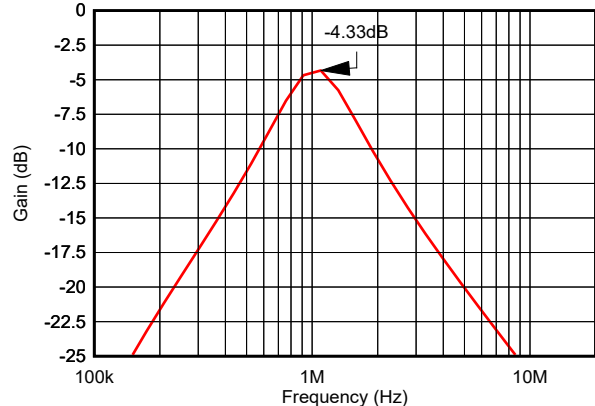

**Figure 8-3. Band-Pass Filter Frequency Response**

## 8.3 Power Supply Recommendations

The LOG300 contains two supply pins. The analog power supply pin (VCC) and the frequency detect block supply pin (Freq\_Supply). Both pins can be biased at any voltage between 3V to 5.25V with respect to the AGND. While both these pins are connected to different circuitry internally, TI recommends to connect both of these pins to the same potential. Provide separate decoupling capacitors, resistors, and ferrite beads to these supply pins (see [Section 8.4.2](#)) to maintain sufficient immunity against cross coupling.

The LOG300 is sensitive to the noise coupling through the supply pins. Use a low-pass filter on the supply line with a cutoff frequency less than the incoming frequency signal.

For example if the incoming signal is 100kHz, and the band-pass filter has been tuned to achieve a center frequency of 100kHz, design a RC filter on the supply with a cut off frequency of at least 10kHz. For a higher signal frequency the RC values start diminishing to smaller values and hence the cut off frequency can be parked to any appropriate value.

An external band-pass filter if used between the LNA and the LOG detector block, along with a low-pass filter on the supply pins provides enough power-supply rejection to keep Log\_Out unaffected.

## 8.4 Layout

### 8.4.1 Layout Guidelines

Follow these instructions to improve the performance and noise immunity of the LOG300:

- Provide a star connection style supply for Freq\_supply and VCC. This connection enables better noise immunity and decoupling.
- Design Log\_Inp, Log\_Inm and LNA\_In traces with guard traces to improve immunity against noise pickup. Use shielding when possible to improve radiated noise immunity.
- Place small capacitors on the AFE and LNA enable pins to allow high-frequency noise to be grounded before entering into the device.
- As per [Section 7.3.2](#) the impedance seen from Log\_Inp and Log\_Inm to the external circuit must be the same. The trace length to Log\_Inp and Log\_Inm must be kept similar to keep impedance matched.
- Keep minimal capacitance at the Freq\_Out pin either by placing the load circuit close to the pin or by removing the analog ground plane under the output trace or both.
- Dedicate one layer of the PCB for a solid analog ground pour to terminate all the capacitors used across the pins using sufficient vias.

### 8.4.2 Layout Example

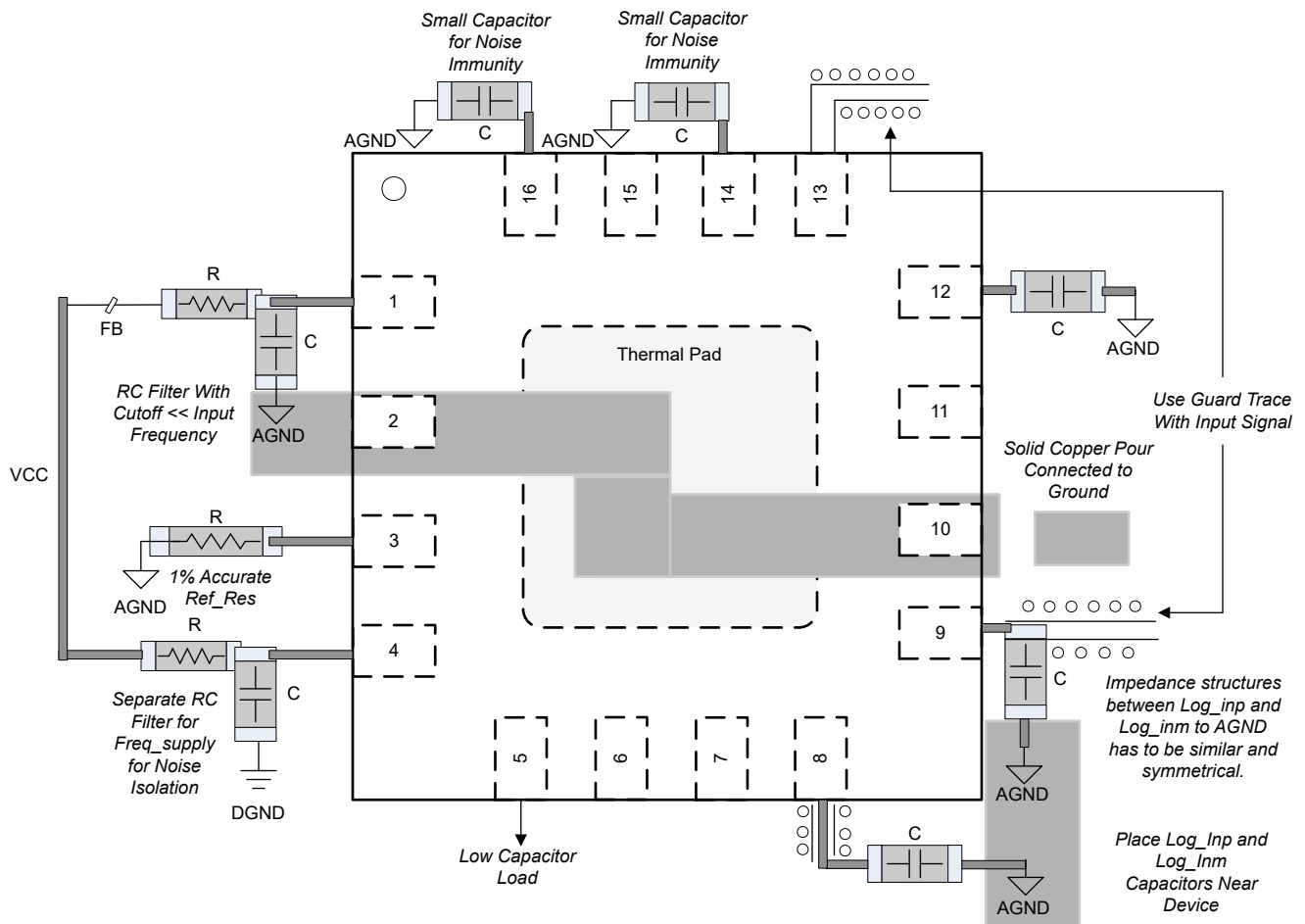

Figure 8-4. Layout Example

## 9 Device and Documentation Support

TI offers an extensive line of development tools. Tools and software to evaluate the performance of the device, generate code, and develop solutions are listed below.

### 9.1 Third-Party Products Disclaimer

TI'S PUBLICATION OF INFORMATION REGARDING THIRD-PARTY PRODUCTS OR SERVICES DOES NOT CONSTITUTE AN ENDORSEMENT REGARDING THE SUITABILITY OF SUCH PRODUCTS OR SERVICES OR A WARRANTY, REPRESENTATION OR ENDORSEMENT OF SUCH PRODUCTS OR SERVICES, EITHER ALONE OR IN COMBINATION WITH ANY TI PRODUCT OR SERVICE.

### 9.2 Receiving Notification of Documentation Updates

To receive notification of documentation updates, navigate to the device product folder on [ti.com](http://ti.com). Click on *Notifications* to register and receive a weekly digest of any product information that has changed. For change details, review the revision history included in any revised document.

### 9.3 Support Resources

[TI E2E™ support forums](#) are an engineer's go-to source for fast, verified answers and design help — straight from the experts. Search existing answers or ask your own question to get the quick design help you need.

Linked content is provided "AS IS" by the respective contributors. They do not constitute TI specifications and do not necessarily reflect TI's views; see TI's [Terms of Use](#).

### 9.4 Trademarks

TI E2E™ is a trademark of Texas Instruments.

All trademarks are the property of their respective owners.

### 9.5 Electrostatic Discharge Caution



This integrated circuit can be damaged by ESD. Texas Instruments recommends that all integrated circuits be handled with appropriate precautions. Failure to observe proper handling and installation procedures can cause damage.

ESD damage can range from subtle performance degradation to complete device failure. Precision integrated circuits may be more susceptible to damage because very small parametric changes could cause the device not to meet its published specifications.

### 9.6 Glossary

[TI Glossary](#) This glossary lists and explains terms, acronyms, and definitions.

## 10 Revision History

NOTE: Page numbers for previous revisions may differ from page numbers in the current version.

Changes from Revision A (October 2024) to Revision B (December 2024)	Page
• Added RGT package to data sheet.....	1
• Added minimum output voltage for RGT package.....	6
• Changed minimum output voltage at $T_A = -40^\circ\text{C}$ to $+125^\circ\text{C}$ in Electrical Charecteristics LNA + Log Detector (AFE).....	8
• Updated Figure 5-34, <i>Log-Detector Output at Various Frequencies</i> , to fix broken X-axis scale.....	15
• Updated Figure 7-1, <i>Impedance Structure at Log_Inp and Log_Inm</i> .....	18
• Updated Figure 7-2, <i>Impedance vs Frequency at Log_Inp and Log_Inm</i> .....	18

Changes from Revision * (September 2024) to Revision A (October 2024)	Page
• Changed document status from advanced information (preview) to production data (active).....	1



## 11 Mechanical, Packaging, and Orderable Information

The following pages include mechanical, packaging, and orderable information. This information is the most current data available for the designated devices. This data is subject to change without notice and revision of this document. For browser-based versions of this data sheet, refer to the left-hand navigation.

**PACKAGING INFORMATION**

Orderable Device	Status (1)	Package Type	Package Drawing	Pins	Package Qty	Eco Plan (2)	Lead finish/ Ball material (6)	MSL Peak Temp (3)	Op Temp (°C)	Device Marking (4/5)	Samples
LOG300DR	ACTIVE	SOIC	D	16	3000	RoHS & Green	NIPDAU	Level-1-260C-UNLIM	-40 to 125	LOG300D	<a href="#">Samples</a>
LOG300RGTR	ACTIVE	VQFN	RGT	16	3000	RoHS & Green	NIPDAU	Level-1-260C-UNLIM	-40 to 125	LOG300	<a href="#">Samples</a>
XLOG300RGTR	ACTIVE	VQFN	RGT	16	3000	TBD	Call TI	Call TI	-40 to 125		<a href="#">Samples</a>

(1) The marketing status values are defined as follows:

**ACTIVE:** Product device recommended for new designs.

**LIFEBUY:** TI has announced that the device will be discontinued, and a lifetime-buy period is in effect.

**NRND:** Not recommended for new designs. Device is in production to support existing customers, but TI does not recommend using this part in a new design.

**PREVIEW:** Device has been announced but is not in production. Samples may or may not be available.

**OBSOLETE:** TI has discontinued the production of the device.

(2) **RoHS:** TI defines "RoHS" to mean semiconductor products that are compliant with the current EU RoHS requirements for all 10 RoHS substances, including the requirement that RoHS substance do not exceed 0.1% by weight in homogeneous materials. Where designed to be soldered at high temperatures, "RoHS" products are suitable for use in specified lead-free processes. TI may reference these types of products as "Pb-Free".

**RoHS Exempt:** TI defines "RoHS Exempt" to mean products that contain lead but are compliant with EU RoHS pursuant to a specific EU RoHS exemption.

**Green:** TI defines "Green" to mean the content of Chlorine (Cl) and Bromine (Br) based flame retardants meet JS709B low halogen requirements of <=1000ppm threshold. Antimony trioxide based flame retardants must also meet the <=1000ppm threshold requirement.

(3) MSL, Peak Temp. - The Moisture Sensitivity Level rating according to the JEDEC industry standard classifications, and peak solder temperature.

(4) There may be additional marking, which relates to the logo, the lot trace code information, or the environmental category on the device.

(5) Multiple Device Markings will be inside parentheses. Only one Device Marking contained in parentheses and separated by a "-" will appear on a device. If a line is indented then it is a continuation of the previous line and the two combined represent the entire Device Marking for that device.

(6) Lead finish/Ball material - Orderable Devices may have multiple material finish options. Finish options are separated by a vertical ruled line. Lead finish/Ball material values may wrap to two lines if the finish value exceeds the maximum column width.

**Important Information and Disclaimer:**The information provided on this page represents TI's knowledge and belief as of the date that it is provided. TI bases its knowledge and belief on information provided by third parties, and makes no representation or warranty as to the accuracy of such information. Efforts are underway to better integrate information from third parties. TI has taken and continues to take reasonable steps to provide representative and accurate information but may not have conducted destructive testing or chemical analysis on incoming materials and chemicals. TI and TI suppliers consider certain information to be proprietary, and thus CAS numbers and other limited information may not be available for release.

In no event shall TI's liability arising out of such information exceed the total purchase price of the TI part(s) at issue in this document sold by TI to Customer on an annual basis.

**TAPE AND REEL INFORMATION**

**QUADRANT ASSIGNMENTS FOR PIN 1 ORIENTATION IN TAPE**

\*All dimensions are nominal

Device	Package Type	Package Drawing	Pins	SPQ	Reel Diameter (mm)	Reel Width W1 (mm)	A0 (mm)	B0 (mm)	K0 (mm)	P1 (mm)	W (mm)	Pin1 Quadrant
LOG300DR	SOIC	D	16	3000	330.0	16.4	6.5	10.3	2.1	8.0	16.0	Q1
LOG300RGTR	VQFN	RGT	16	3000	330.0	12.4	3.3	3.3	1.1	8.0	12.0	Q2

## TAPE AND REEL BOX DIMENSIONS



\*All dimensions are nominal

Device	Package Type	Package Drawing	Pins	SPQ	Length (mm)	Width (mm)	Height (mm)
LOG300DR	SOIC	D	16	3000	353.0	353.0	32.0
LOG300RGTR	VQFN	RGT	16	3000	367.0	367.0	35.0

D (R-PDSO-G16)

PLASTIC SMALL OUTLINE



- NOTES:
- A. All linear dimensions are in inches (millimeters).
  - B. This drawing is subject to change without notice.
  - C. Body length does not include mold flash, protrusions, or gate burrs. Mold flash, protrusions, or gate burrs shall not exceed 0.006 (0,15) each side.
  - D. Body width does not include interlead flash. Interlead flash shall not exceed 0.017 (0,43) each side.
  - E. Reference JEDEC MS-012 variation AC.

**RGT 16**

**GENERIC PACKAGE VIEW**

**VQFN - 1 mm max height**

PLASTIC QUAD FLATPACK - NO LEAD

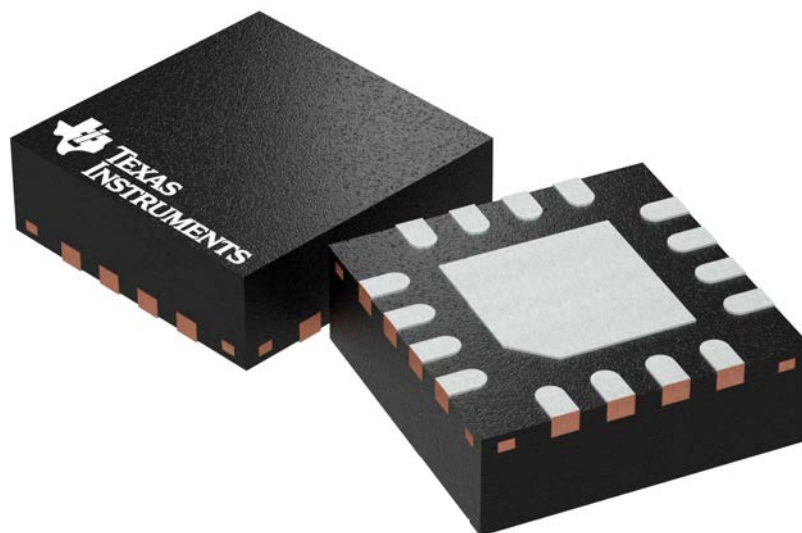

Images above are just a representation of the package family, actual package may vary.  
Refer to the product data sheet for package details.

4203495/1

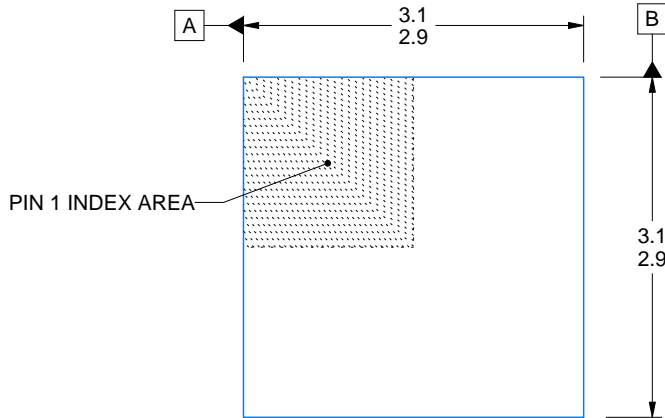
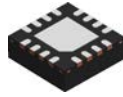

SIDE WALL METAL THICKNESS DIM A	
OPTION 1	OPTION 2
0.1	0.2

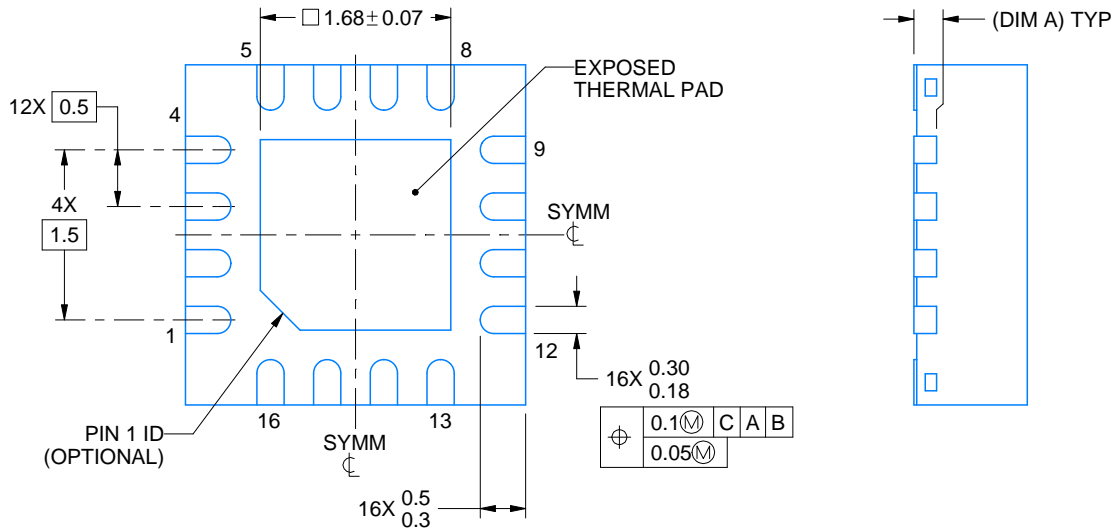
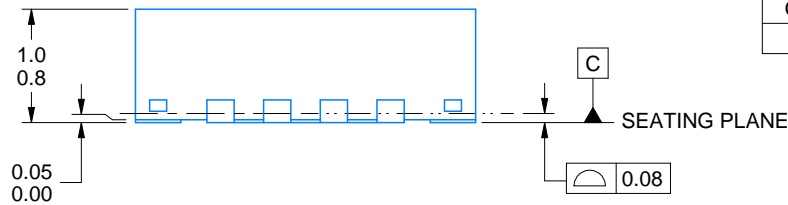

4222419/D 04/2022

NOTES:

1. All linear dimensions are in millimeters. Any dimensions in parenthesis are for reference only. Dimensioning and tolerancing per ASME Y14.5M.
2. This drawing is subject to change without notice.
3. The package thermal pad must be soldered to the printed circuit board for thermal and mechanical performance.



# EXAMPLE BOARD LAYOUT

RGT0016C

VQFN - 1 mm max height

PLASTIC QUAD FLATPACK - NO LEAD

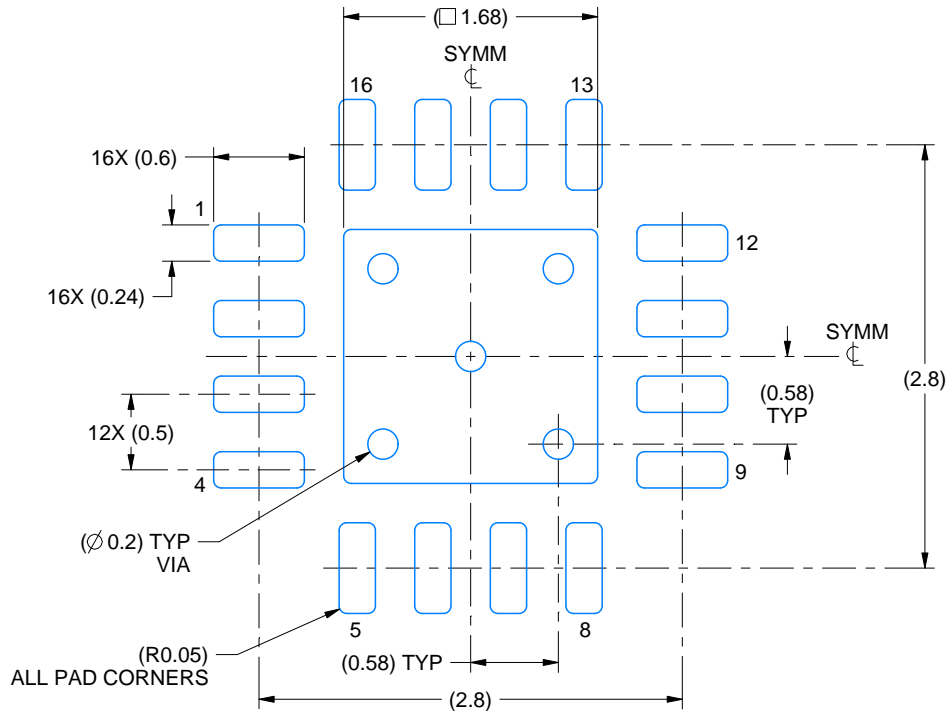

LAND PATTERN EXAMPLE  
EXPOSED METAL SHOWN  
SCALE:20X

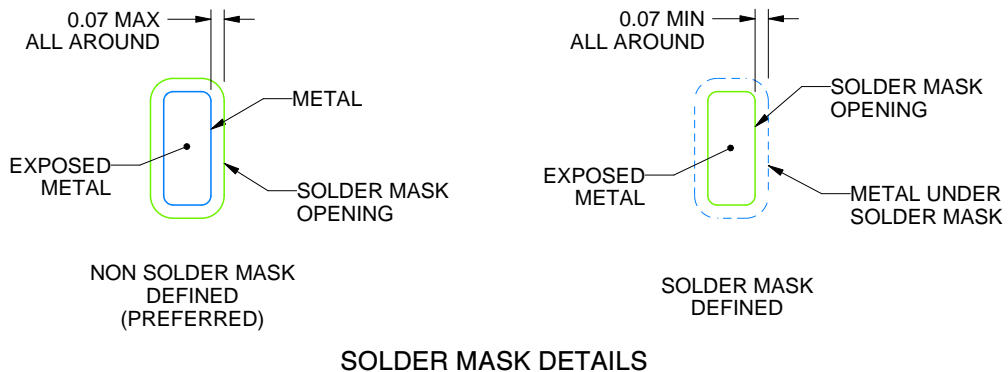

SOLDER MASK DETAILS

4222419/D 04/2022

NOTES: (continued)

4. This package is designed to be soldered to a thermal pad on the board. For more information, see Texas Instruments literature number SLUA271 ([www.ti.com/lit/slua271](http://www.ti.com/lit/slua271)).
5. Vias are optional depending on application, refer to device data sheet. If any vias are implemented, refer to their locations shown on this view. It is recommended that vias under paste be filled, plugged or tented.

# EXAMPLE STENCIL DESIGN

RGT0016C

VQFN - 1 mm max height

PLASTIC QUAD FLATPACK - NO LEAD

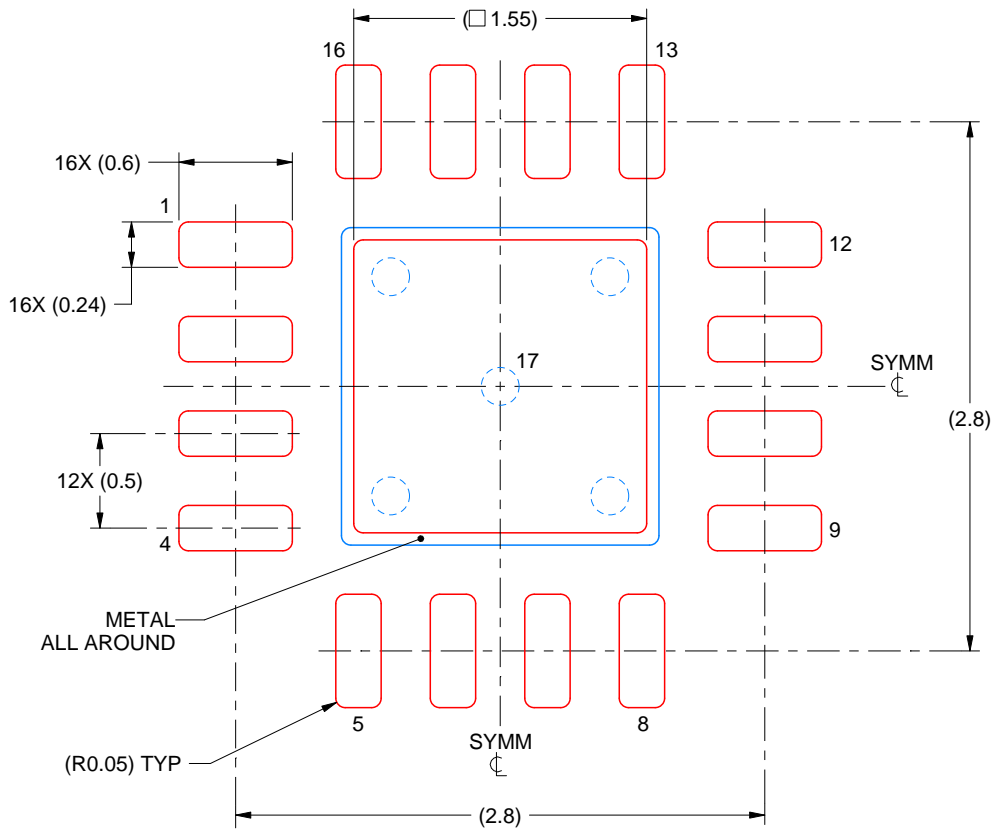

**SOLDER PASTE EXAMPLE**  
BASED ON 0.125 mm THICK STENCIL

EXPOSED PAD 17:  
85% PRINTED SOLDER COVERAGE BY AREA UNDER PACKAGE  
SCALE:25X

4222419/D 04/2022

NOTES: (continued)

6. Laser cutting apertures with trapezoidal walls and rounded corners may offer better paste release. IPC-7525 may have alternate design recommendations.

## IMPORTANT NOTICE AND DISCLAIMER

TI PROVIDES TECHNICAL AND RELIABILITY DATA (INCLUDING DATA SHEETS), DESIGN RESOURCES (INCLUDING REFERENCE DESIGNS), APPLICATION OR OTHER DESIGN ADVICE, WEB TOOLS, SAFETY INFORMATION, AND OTHER RESOURCES "AS IS" AND WITH ALL FAULTS, AND DISCLAIMS ALL WARRANTIES, EXPRESS AND IMPLIED, INCLUDING WITHOUT LIMITATION ANY IMPLIED WARRANTIES OF MERCHANTABILITY, FITNESS FOR A PARTICULAR PURPOSE OR NON-INFRINGEMENT OF THIRD PARTY INTELLECTUAL PROPERTY RIGHTS.

These resources are intended for skilled developers designing with TI products. You are solely responsible for (1) selecting the appropriate TI products for your application, (2) designing, validating and testing your application, and (3) ensuring your application meets applicable standards, and any other safety, security, regulatory or other requirements.

These resources are subject to change without notice. TI grants you permission to use these resources only for development of an application that uses the TI products described in the resource. Other reproduction and display of these resources is prohibited. No license is granted to any other TI intellectual property right or to any third party intellectual property right. TI disclaims responsibility for, and you will fully indemnify TI and its representatives against, any claims, damages, costs, losses, and liabilities arising out of your use of these resources.

TI's products are provided subject to [TI's Terms of Sale](#) or other applicable terms available either on [ti.com](https://www.ti.com) or provided in conjunction with such TI products. TI's provision of these resources does not expand or otherwise alter TI's applicable warranties or warranty disclaimers for TI products.

TI objects to and rejects any additional or different terms you may have proposed.

Mailing Address: Texas Instruments, Post Office Box 655303, Dallas, Texas 75265  
Copyright © 2024, Texas Instruments Incorporated