

# OPA396 Precision, Low $I_Q$ , Low Input Bias Current Op Amp

## 1 Features

- Low  $I_Q$ : 23.5  $\mu\text{A}$
- Gain bandwidth product: 1 MHz
- Low input bias current: 10 fA (typical)
- Low offset voltage:  $\pm 100 \mu\text{V}$  (maximum)
- Low drift:  $\pm 1.2 \mu\text{V}/^\circ\text{C}$
- Low supply voltage operation: 1.7 V to 5.5 V
- Input common mode range  $\pm 100 \text{ mV}$  beyond rail
- Fast slew rate: 1 V/ $\mu\text{s}$
- High load capacitance drive
- High output current drive: 60 mA
- Rail-to-rail output
- EMI/RFI filtered inputs
- Small packages: SC70 and WCSP (Preview)

## 2 Applications

- [Portable electronics](#)
- [Flow transmitter](#)
- [Blood glucose monitor](#)
- [Process analytics \(pH, gas, force, humidity\)](#)
- [Temperature transmitter](#)
- [Pressure transmitter](#)
- [Medical sensor patches](#)
- [Building automation](#)
- [Wearable fitness and activity monitor](#)
- [Gas detector](#)
- [Analog security camera](#)

## 3 Description

The OPA396 features a combination of high bandwidth (1 MHz) along with very low quiescent current (23.5  $\mu\text{A}$ ) in a high-precision amplifier. These features combined with rail-to-rail input and output make this device an exceptional choice in high-gain, low-power applications. Ultra-low input bias current of 10 fA, 100  $\mu\text{V}$  of offset (maximum), and 1.2  $\mu\text{V}/^\circ\text{C}$  of drift over temperature help maintain high precision in ratiometric and amperometric sensor front ends that have demanding low-power requirements.

The OPA396 uses Texas Instrument's proprietary e-trim™ operational amplifier technology, enabling a unique combination of ultra-low offset and low input offset drift without the need for any input switching or auto-zero techniques. The CMOS-based technology platform also features a modern, robust output stage design that is tolerant of high output capacitance, alleviating stability problems that are common in typical low-power amplifiers.

### Device Information

PART NUMBER	PACKAGE <sup>(1)</sup>	BODY SIZE (NOM)
OPA396	SC-70 (5)	2.00 mm x 1.25 mm

(1) For all available packages, see the package option addendum at the end of the data sheet.

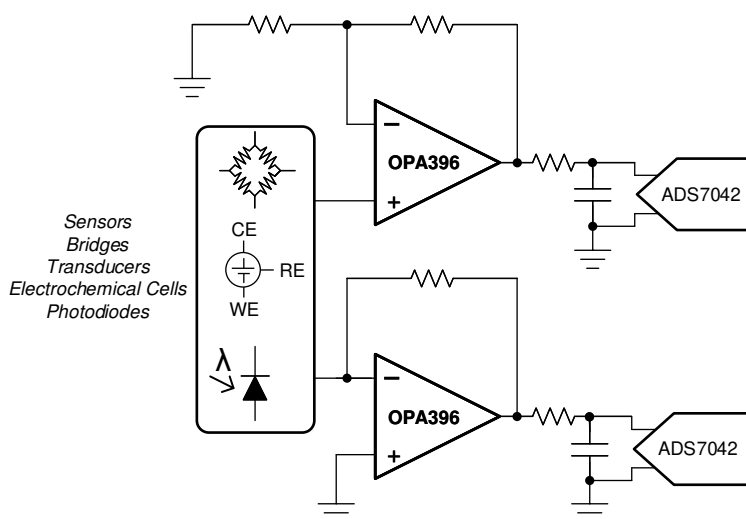

**High-Input-Impedance, Low-Offset Buffer**



## Table of Contents

<b>1 Features</b> .....	<b>1</b>	<b>8 Application and Implementation</b> .....	<b>17</b>
<b>2 Applications</b> .....	<b>1</b>	8.1 Application Information.....	17
<b>3 Description</b> .....	<b>1</b>	8.2 Typical Applications.....	17
<b>4 Revision History</b> .....	<b>2</b>	<b>9 Power Supply Recommendations</b> .....	<b>21</b>
<b>5 Pin Configuration and Functions</b> .....	<b>3</b>	<b>10 Layout</b> .....	<b>21</b>
<b>6 Specifications</b> .....	<b>4</b>	10.1 Layout Guidelines.....	21
6.1 Absolute Maximum Ratings .....	4	10.2 Layout Example.....	21
6.2 ESD Ratings .....	4	<b>11 Device and Documentation Support</b> .....	<b>22</b>
6.3 Recommended Operating Conditions .....	4	11.1 Device Support.....	22
6.4 Thermal Information .....	4	11.2 Documentation Support.....	22
6.5 Electrical Characteristics .....	5	11.3 Receiving Notification of Documentation Updates..	22
6.6 Typical Characteristics.....	7	11.4 Support Resources.....	22
<b>7 Detailed Description</b> .....	<b>14</b>	11.5 Trademarks.....	22
7.1 Overview.....	14	11.6 Electrostatic Discharge Caution.....	22
7.2 Functional Block Diagram.....	14	11.7 Glossary.....	23
7.3 Feature Description.....	15	<b>12 Mechanical, Packaging, and Orderable</b>	
7.4 Device Functional Modes.....	16	<b>Information</b> .....	<b>23</b>

## 4 Revision History

DATE	REVISION	NOTES
July 2021	*	Initial Release

## 5 Pin Configuration and Functions

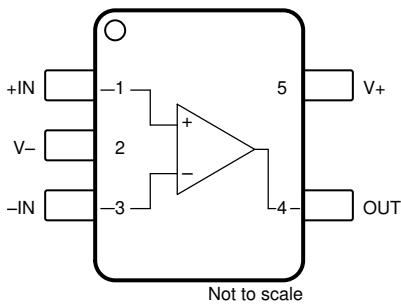

**Figure 5-1. DCK Package, 5-Pin SC70, Top View**

**Table 5-1. Pin Functions**

PIN		I/O	DESCRIPTION
NAME	NO.		
-IN	3	I	Inverting input
+IN	1	I	Noninverting input
OUT	4	O	Output
V-	2	—	Negative (lowest) power supply
V+	5	—	Positive (highest) power supply

## 6 Specifications

### 6.1 Absolute Maximum Ratings

over operating free-air temperature range (unless otherwise noted)<sup>(1)</sup>

			MIN	MAX	UNIT
V <sub>S</sub>	Supply voltage, V <sub>S</sub> = (V+) – (V–)	Single-supply		6	V
		Dual-supply		±3	
	Input voltage, all pins	Common-mode	(V–) – 0.5	(V+) + 0.5	V
		Differential		(V+) – (V–) + 0.5	
	Input current, all pins			±10	mA
	Output short circuit <sup>(2)</sup>		Continuous	Continuous	
T <sub>A</sub>	Operating temperature		–55	150	°C
T <sub>stg</sub>	Storage temperature		–65	150	°C

- (1) Operation outside the Absolute Maximum Ratings may cause permanent device damage. Absolute Maximum Ratings do not imply functional operation of the device at these or any other conditions beyond those listed under Recommended Operating Conditions. If used outside the Recommended Operating Conditions but within the Absolute Maximum Ratings, the device may not be fully functional, and this may affect device reliability, functionality, performance, and shorten the device lifetime.
- (2) Short-circuit to ground, one amplifier per package.

### 6.2 ESD Ratings

			VALUE	UNIT
V <sub>(ESD)</sub>	Electrostatic discharge	Human-body model (HBM), per ANSI/ESDA/JEDEC JS-001 <sup>(1)</sup>	±2000	V
		Charged-device model (CDM), per JEDEC specification JESD22-C101 <sup>(2)</sup>	±500	

- (1) JEDEC document JEP155 states that 500-V HBM allows safe manufacturing with a standard ESD control process.
- (2) JEDEC document JEP157 states that 250-V CDM allows safe manufacturing with a standard ESD control process.

### 6.3 Recommended Operating Conditions

over operating free-air temperature range (unless otherwise noted)

			MIN	NOM	MAX	UNIT
V <sub>S</sub>	Supply voltage, V <sub>S</sub> = (V+) – (V–)	Single-supply	1.7		5.5	V
		Dual-supply	±0.85		±2.75	
	Input voltage	Differential	–0.5		+0.5	
T <sub>A</sub>	Specified temperature		–40		125	°C

### 6.4 Thermal Information

THERMAL METRIC <sup>(1)</sup>		OPA396	UNIT
		DCK (SC70)	
		5 PINS	
R <sub>θJA</sub>	Junction-to-ambient thermal resistance	214	°C/W
R <sub>θJC(top)</sub>	Junction-to-case (top) thermal resistance	115	°C/W
R <sub>θJB</sub>	Junction-to-board thermal resistance	58	°C/W
Ψ <sub>JT</sub>	Junction-to-top characterization parameter	29	°C/W
Ψ <sub>JB</sub>	Junction-to-board characterization parameter	58	°C/W
R <sub>θJC(bot)</sub>	Junction-to-case (bottom) thermal resistance	N/A	°C/W

- (1) For more information about traditional and new thermal metrics, see the [Semiconductor and IC Package Thermal Metrics](#) application report.

## 6.5 Electrical Characteristics

at  $V_S = 1.7\text{ V to }5.5\text{ V}$ ,  $T_A = 25^\circ\text{C}$ , and  $V_{CM} = V_S / 2$  (unless otherwise noted)

PARAMETER		TEST CONDITIONS	MIN	TYP	MAX	UNIT
<b>OFFSET VOLTAGE</b>						
$V_{OS}$	Input offset voltage	$V_S = 5.0\text{ V}$		$\pm 10$	$\pm 100$	$\mu\text{V}$
		$V_{CM} = (V+) - 0.3\text{ V}$ , $V_S = 5.0\text{ V}$		$\pm 60$	$\pm 750$	
		$V_{CM} = (V-) - 0.1\text{ V}$		$\pm 15$	$\pm 100$	
		$T_A = -40^\circ\text{C to }+125^\circ\text{C}^{(1)}$			$\pm 600$	
$dV_{OS}/dT$	Input offset voltage drift	$T_A = 0^\circ\text{C to }85^\circ\text{C}^{(1)}$		$\pm 1$	$\pm 5$	$\mu\text{V}/^\circ\text{C}$
		$T_A = -40^\circ\text{C to }+125^\circ\text{C}^{(1)}$		$\pm 1.2$	$\pm 6$	
PSRR	Power supply rejection ratio	$V_{CM} = (V-) - 0.1\text{ V}$			40	$\mu\text{V/V}$
<b>INPUT BIAS CURRENT</b>						
$I_B$	Input bias current	$T_A = 25^\circ\text{C}^{(1)}$		$\pm 0.01$	10	$\text{pA}$
		$T_A = -40^\circ\text{C to }+125^\circ\text{C}^{(1)}$		$\pm 3.78$		
$I_{OS}$	Input offset current	$T_A = 25^\circ\text{C}^{(1)}$		$\pm 0.01$	10	$\text{pA}$
		$T_A = -40^\circ\text{C to }+125^\circ\text{C}^{(1)}$		$\pm 1.00$		
<b>NOISE</b>						
	Input voltage noise	$f = 0.1\text{ Hz to }10\text{ Hz}$ , $V_{CM} = V$		0.91		$\mu\text{V}_{RMS}$
				6.0		$\mu\text{V}_{PP}$
$e_n$	Input voltage noise density	$f = 10\text{ Hz}$		130		$\text{nV}/\sqrt{\text{Hz}}$
		$f = 1\text{ kHz}$		60		
		$f = 10\text{ kHz}$		55		
$i_n$	Input current noise density	$f = 1\text{ kHz}$		30		$\text{fA}/\sqrt{\text{Hz}}$
<b>INPUT VOLTAGE</b>						
$V_{CM}$	Common-mode voltage	$T_A = -40^\circ\text{C to }+125^\circ\text{C}^{(1)}$	$(V-) - 0.1\text{ V}$		$(V+) + 0.1\text{ V}$	V
CMRR	Common-mode rejection ratio	$(V-) - 0.1\text{ V} \leq V_{CM} \leq (V+) - 1.5\text{ V}$		89	100	dB
			$(V-) - 0.1\text{ V} \leq V_{CM} \leq (V+) - 1.5\text{ V}$ , $V_S = 5.5\text{ V}$		100	
		$(V+) - 0.6\text{ V} \leq V_{CM} \leq (V+) + 0.1\text{ V}$	$T_A = -40^\circ\text{C to }+125^\circ\text{C}^{(1)}$	90	100	
					69	
<b>INPUT IMPEDANCE</b>						
$Z_{id}$	Differential input impedance			$0.1 \parallel 1$		$\text{G}\Omega \parallel \text{pF}$
$Z_{ic}$	Common-mode input impedance			$1 \parallel 1$		$\text{T}\Omega \parallel \text{pF}$

## 6.5 Electrical Characteristics (continued)

at  $V_S = 1.7\text{ V}$  to  $5.5\text{ V}$ ,  $T_A = 25^\circ\text{C}$ , and  $V_{CM} = V_S / 2$  (unless otherwise noted)

PARAMETER		TEST CONDITIONS		MIN	TYP	MAX	UNIT
<b>OPEN-LOOP GAIN</b>							
$A_{OL}$	Open-loop voltage gain	$V_S = 5.5\text{ V}$	$(V^-) + 0.1\text{ V} < V_O < (V^+) - 0.1\text{ V}$ , $V_{CM} = (V^-) - 100\text{ mV}$ , $R_L = 10\text{ k}\Omega$	100	121		dB
			$(V^-) + 0.45\text{ V} < V_O < (V^+) - 0.45\text{ V}$ , $V_{CM} = (V^-) - 100\text{ mV}$ , $R_L = 2\text{ k}\Omega$	100	121		
		$V_S = 1.7\text{ V}$	$(V^-) + 0.1\text{ V} < V_O < (V^+) - 0.1\text{ V}$ , $V_{CM} = (V^+) - 1.5\text{ V}$ , $R_L = 10\text{ k}\Omega$	90	113		
			$(V^-) + 0.45\text{ V} < V_O < (V^+) - 0.45\text{ V}$ , $V_{CM} = (V^+) - 1.5\text{ V}$ , $R_L = 2\text{ k}\Omega$	90	107		
<b>FREQUENCY RESPONSE</b>							
UGB	Unity-gain bandwidth	$G = 1$	$I_{OUT} = 0\text{ }\mu\text{A}$ , $R_L = 10\text{ k}\Omega$		450		kHz
			$I_{OUT} = 0\text{ }\mu\text{A}$ , $R_L = 50\text{ k}\Omega$		0.85		MHz
			$I_{OUT} = 100\text{ }\mu\text{A}$ , $R_L = 10\text{ k}\Omega$		0.75		
GBW	Gain-bandwidth product				1		MHz
SR	Slew rate	$G = -1, 4\text{-V step}$			1		V/ $\mu\text{s}$
$t_s$	Settling time	To 0.1%, $V_S = 5.5$ , $G = 1$ , 1-V step			8		$\mu\text{s}$
$t_{OR}$	Overload recovery time	$V_{IN} \times G = V_S$			15		$\mu\text{s}$
<b>OUTPUT</b>							
$V_O$	Voltage output swing from rail	No load				3	mV
		$R_L = 10\text{ k}\Omega$				10	
		$R_L = 2\text{ k}\Omega$				40	
		$T_A = -40^\circ\text{C}$ to $+125^\circ\text{C}$ , both rails, $R_L = 10\text{ k}\Omega$ <sup>(1)</sup>				10	
$I_{SC}$	Short-circuit current	$V_S = 5.5\text{ V}$			60		mA
$Z_O$	Open-loop output impedance	$f = 1\text{ MHz}$ , $I_{OUT} = 100\text{ }\mu\text{A}$			4		$\text{k}\Omega$
<b>POWER SUPPLY</b>							
$I_Q$	Quiescent current per amplifier	$V_{CM} = (V^+) - 1.5\text{ V}$			23.5	30	$\mu\text{A}$
			$T_A = -40^\circ\text{C}$ to $+125^\circ\text{C}$ <sup>(1)</sup>			32	

(1) Specification established from device population bench system measurements across multiple lots.

## 6.6 Typical Characteristics

at  $T_A = 25^\circ\text{C}$ ,  $V_S = 5.0\text{ V}$ ,  $V_{CM} = V_S / 2$ ,  $R_{LOAD} = 10\text{ k}\Omega$  connected to  $V_S / 2$ , and  $C_L = 100\text{ pF}$  (unless otherwise noted)

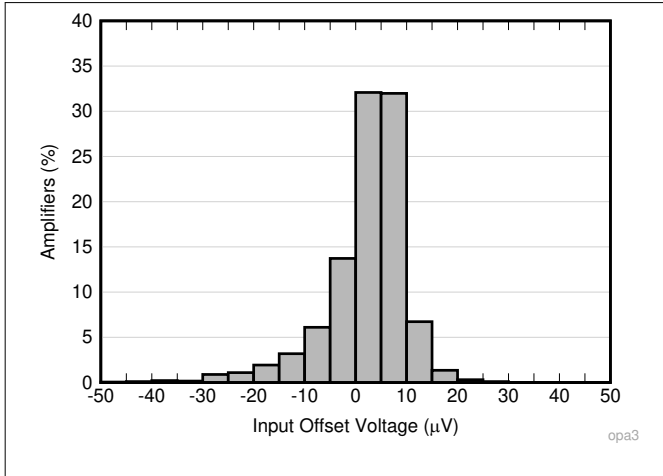

**Figure 6-1. Offset Voltage Distribution**

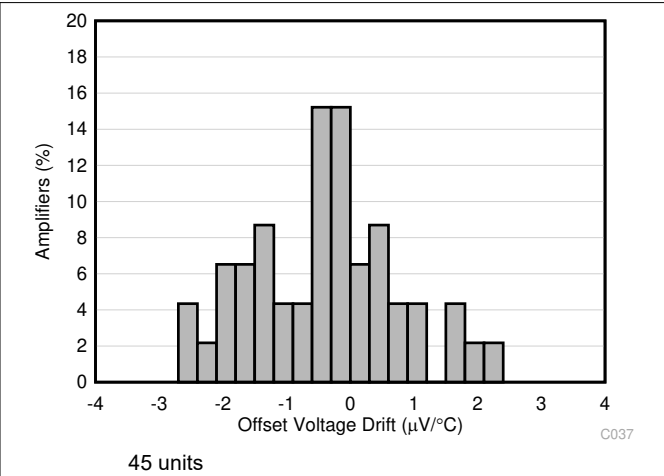

**Figure 6-2. Offset Voltage Drift Distribution ( $-40^\circ\text{C}$  to  $+125^\circ\text{C}$ )**

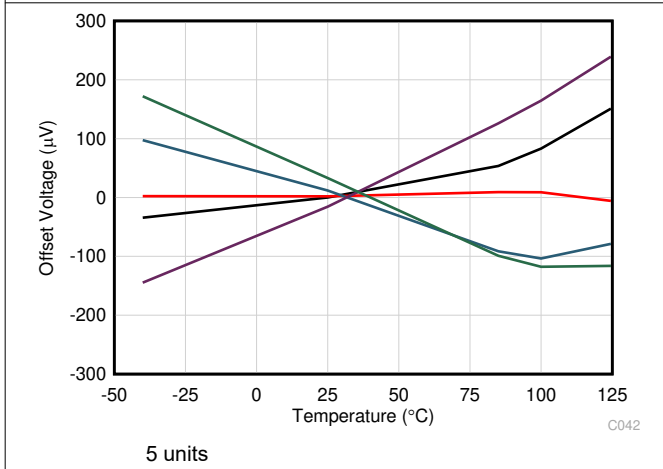

**Figure 6-3. Offset Voltage vs Temperature**

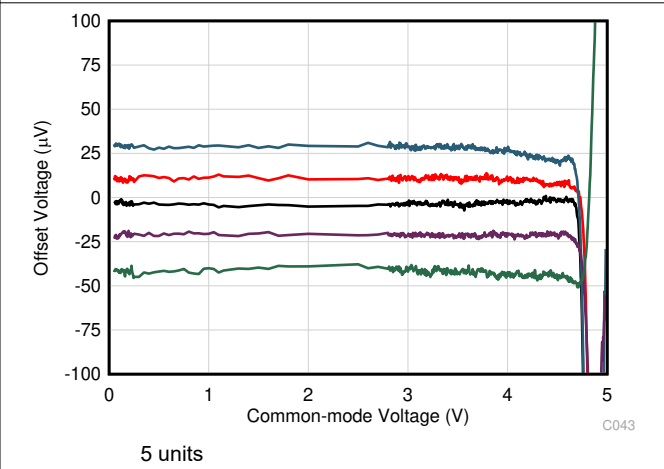

**Figure 6-4. Offset Voltage vs Common-Mode Voltage**

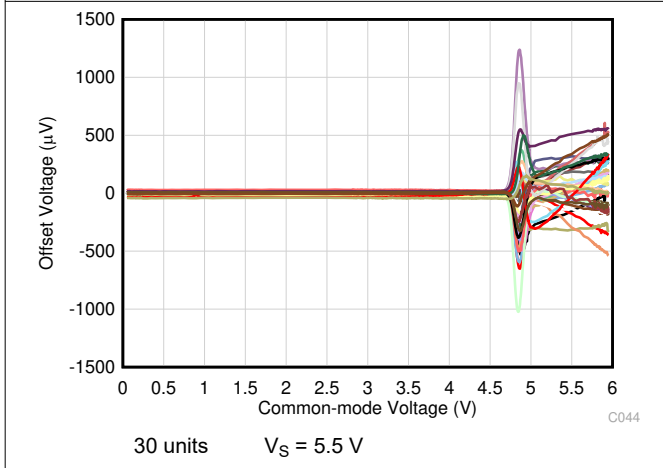

**Figure 6-5. Offset Voltage vs Common-Mode Voltage**

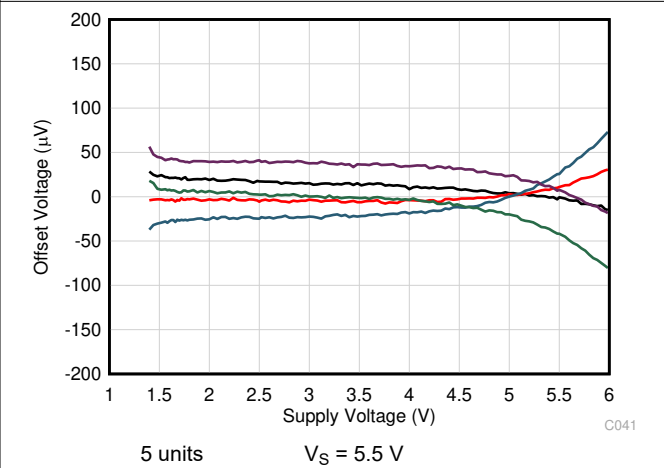

**Figure 6-6. Offset Voltage vs Supply Voltage**

## 6.6 Typical Characteristics (continued)

at  $T_A = 25^\circ\text{C}$ ,  $V_S = 5.0\text{ V}$ ,  $V_{CM} = V_S / 2$ ,  $R_{LOAD} = 10\text{ k}\Omega$  connected to  $V_S / 2$ , and  $C_L = 100\text{ pF}$  (unless otherwise noted)

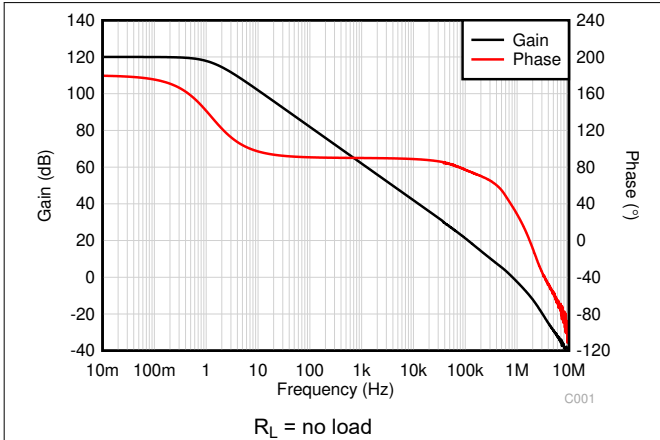

Figure 6-7. Open-Loop Gain and Phase vs Frequency

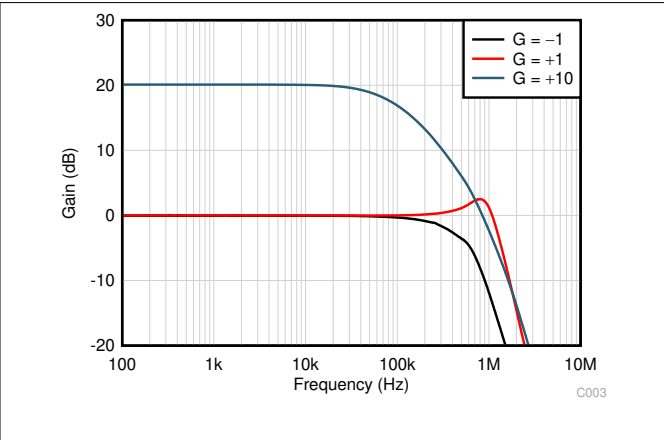

Figure 6-8. Closed-Loop Gain and Phase vs Frequency

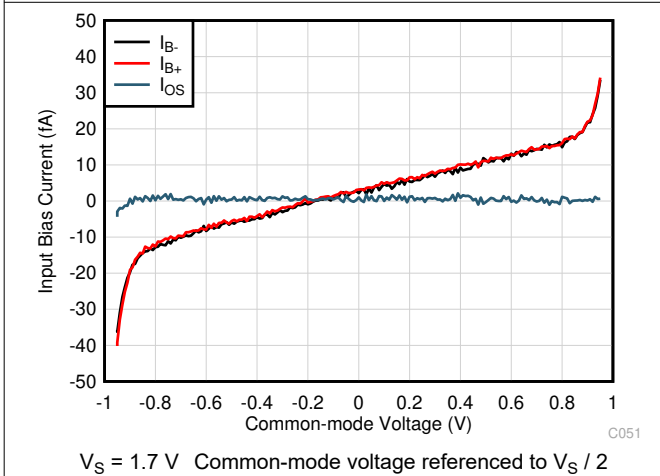

Figure 6-9. Input Bias Current vs Common-Mode Voltage

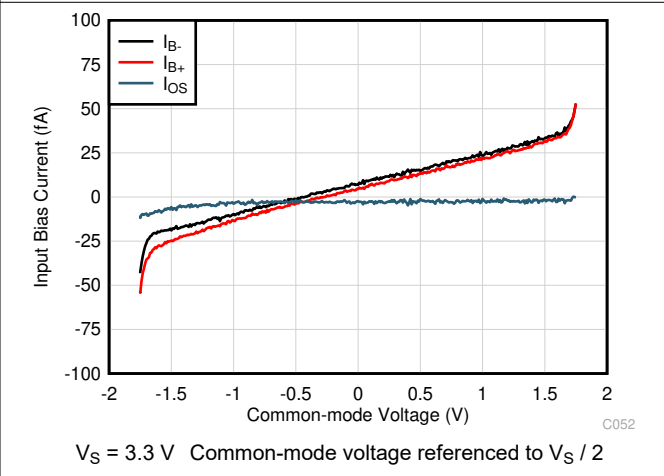

Figure 6-10. Input Bias Current vs Common-Mode Voltage

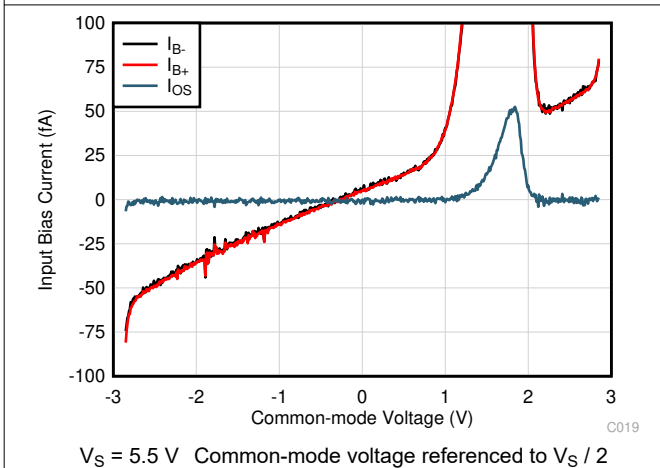

Figure 6-11. Input Bias Current vs Common-Mode Voltage

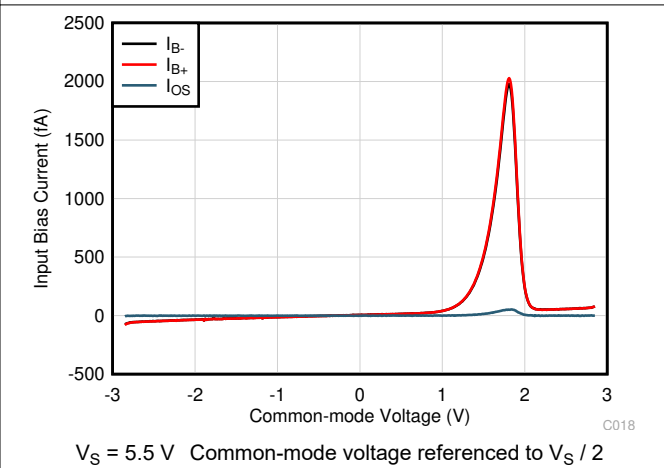
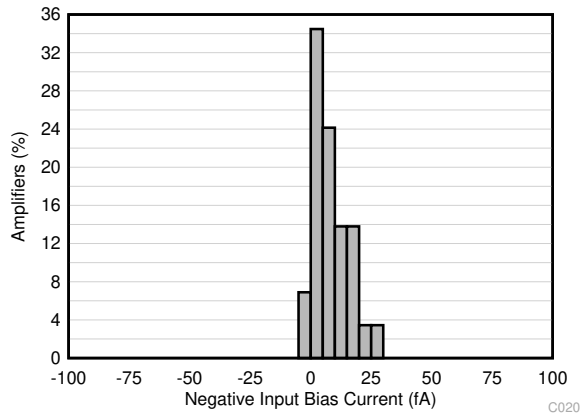

Figure 6-12. Input Bias Current vs Common-Mode Voltage



## 6.6 Typical Characteristics (continued)

at  $T_A = 25^\circ\text{C}$ ,  $V_S = 5.0\text{ V}$ ,  $V_{CM} = V_S / 2$ ,  $R_{LOAD} = 10\text{ k}\Omega$  connected to  $V_S / 2$ , and  $C_L = 100\text{ pF}$  (unless otherwise noted)



**Figure 6-13. Negative Input Bias Current Distribution**

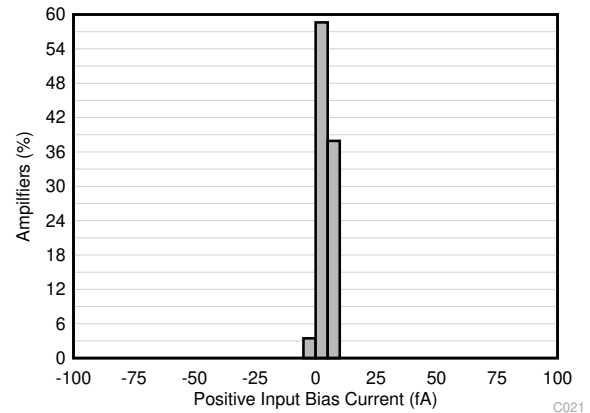

**Figure 6-14. Positive Input Bias Current Distribution**

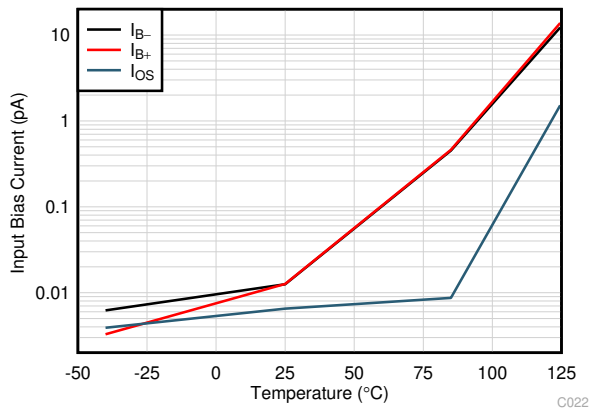

**Figure 6-15. Input Bias Current vs Temperature**

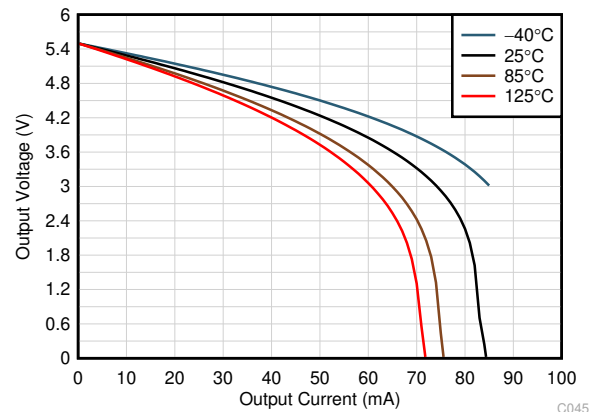

**Figure 6-16. Output Voltage Swing vs Output Current (Maximum Supply)**

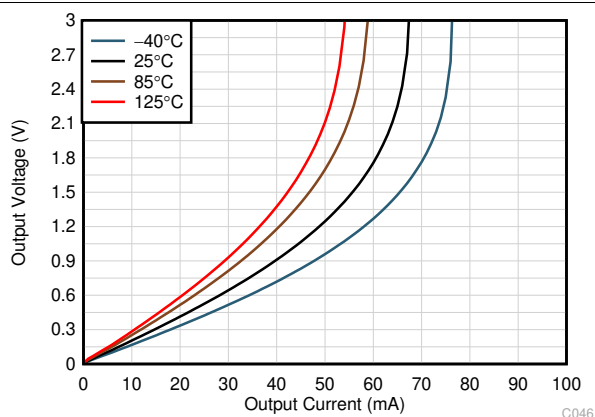

**Figure 6-17. Output Voltage Swing vs Output Current (Maximum Supply)**

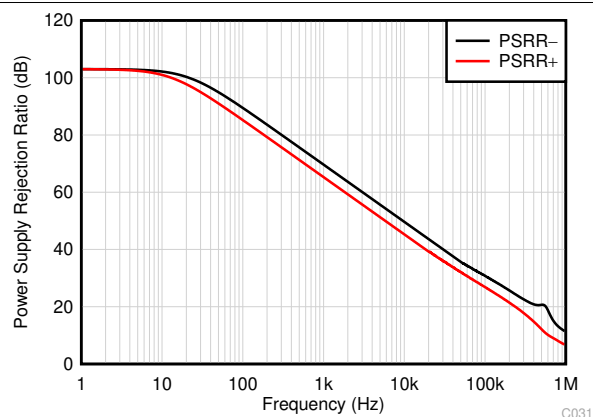

**Figure 6-18. PSRR vs Frequency**

## 6.6 Typical Characteristics (continued)

at  $T_A = 25^\circ\text{C}$ ,  $V_S = 5.0\text{ V}$ ,  $V_{CM} = V_S / 2$ ,  $R_{LOAD} = 10\text{ k}\Omega$  connected to  $V_S / 2$ , and  $C_L = 100\text{ pF}$  (unless otherwise noted)

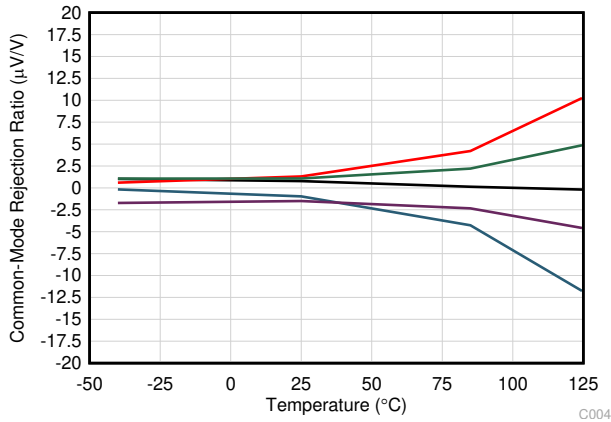

5 units

Figure 6-19. CMRR vs Temperature

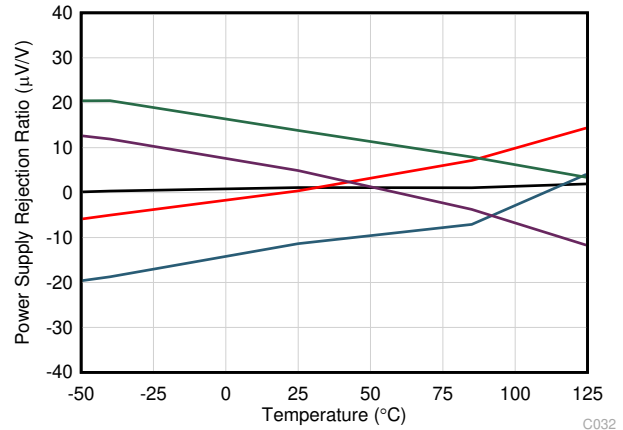

5 units

Figure 6-20. PSRR vs Temperature

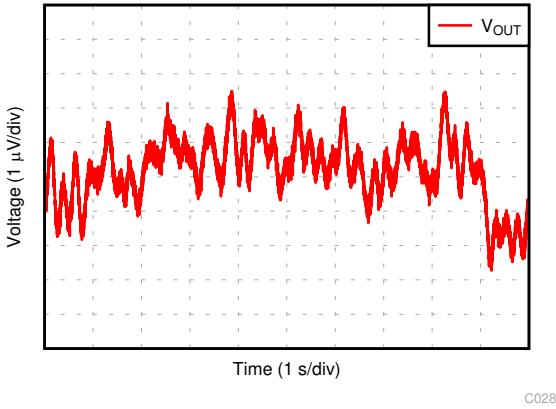

C028

Figure 6-21. 0.1-Hz to 10-Hz Noise

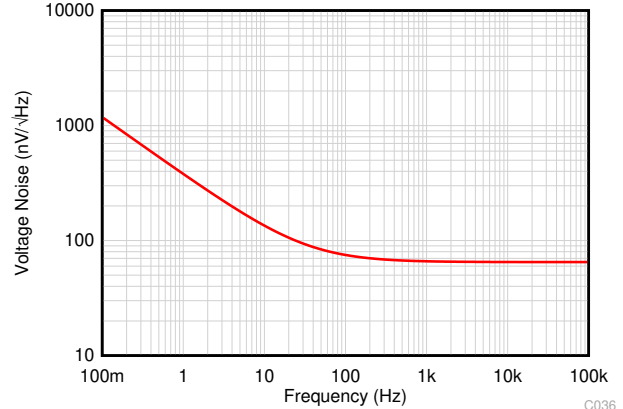

C036

Figure 6-22. Input Voltage Noise Spectral Density vs Frequency

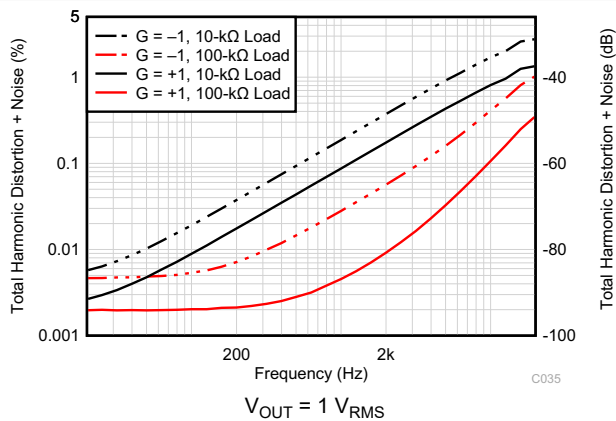

C035

$V_{OUT} = 1\text{ V}_{RMS}$

Figure 6-23. THD+N Ratio vs Frequency

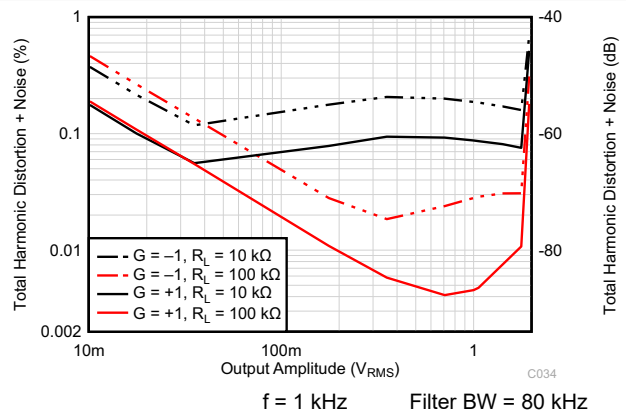

C034

$f = 1\text{ kHz}$  Filter BW = 80 kHz

Figure 6-24. THD+N vs Output Amplitude

## 6.6 Typical Characteristics (continued)

at  $T_A = 25^\circ\text{C}$ ,  $V_S = 5.0\text{ V}$ ,  $V_{CM} = V_S / 2$ ,  $R_{LOAD} = 10\text{ k}\Omega$  connected to  $V_S / 2$ , and  $C_L = 100\text{ pF}$  (unless otherwise noted)

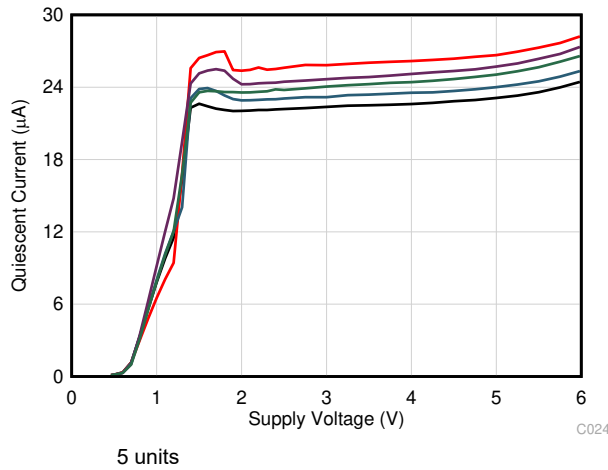

Figure 6-25. Quiescent Current vs Supply Voltage

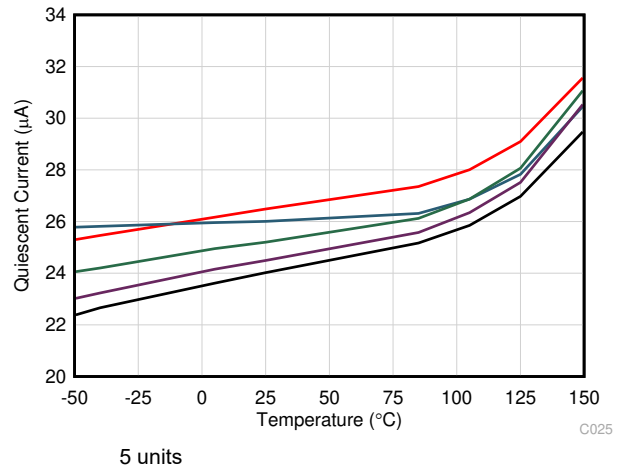

Figure 6-26. Quiescent Current vs Temperature

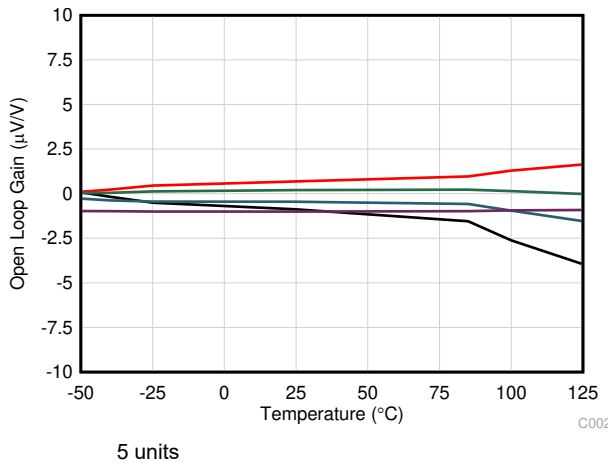

Figure 6-27. Open-Loop Gain vs Temperature

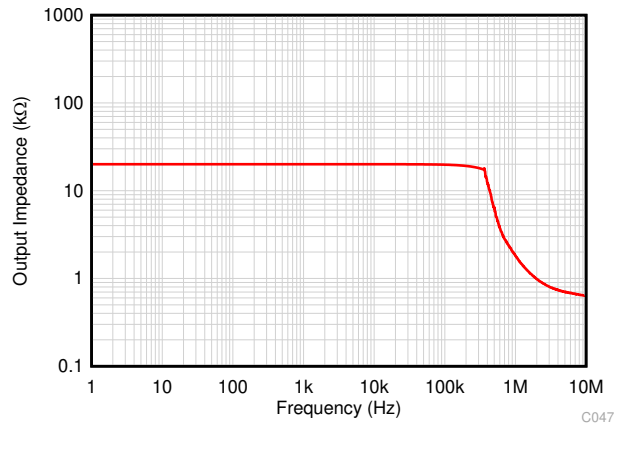

Figure 6-28. Open-Loop Output Impedance vs Frequency

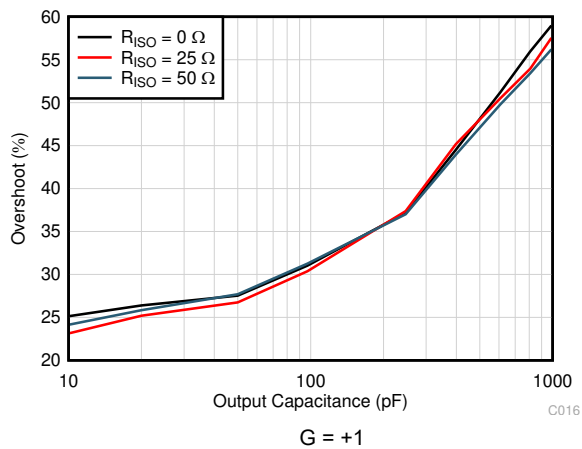

Figure 6-29. Small-Signal Overshoot vs Capacitive Load (10-mV Step)

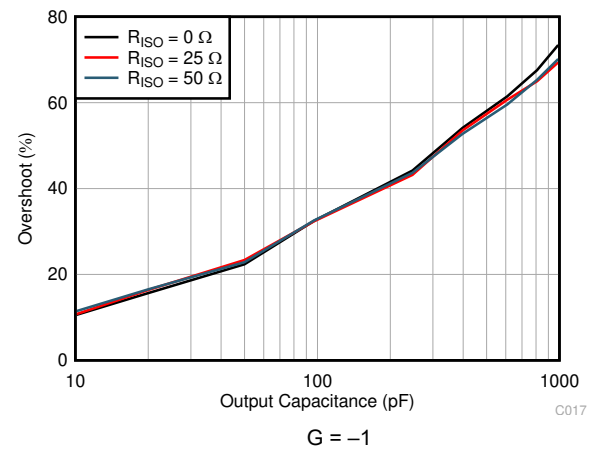
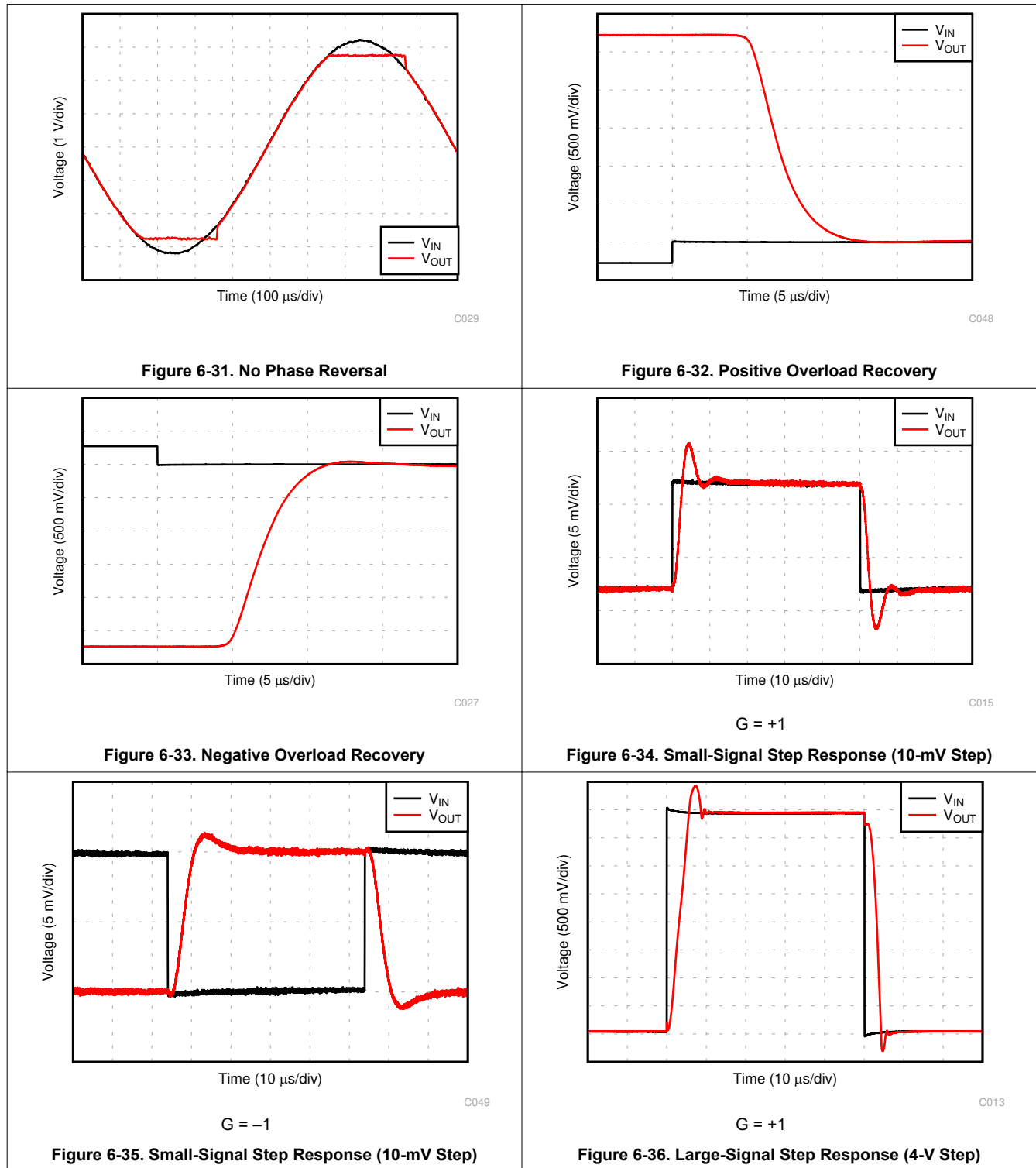

Figure 6-30. Small-Signal Overshoot vs Capacitive Load (10-mV Step)

## 6.6 Typical Characteristics (continued)

at  $T_A = 25^\circ\text{C}$ ,  $V_S = 5.0\text{ V}$ ,  $V_{CM} = V_S / 2$ ,  $R_{LOAD} = 10\text{ k}\Omega$  connected to  $V_S / 2$ , and  $C_L = 100\text{ pF}$  (unless otherwise noted)



## 6.6 Typical Characteristics (continued)

at  $T_A = 25^\circ\text{C}$ ,  $V_S = 5.0\text{ V}$ ,  $V_{CM} = V_S / 2$ ,  $R_{LOAD} = 10\text{ k}\Omega$  connected to  $V_S / 2$ , and  $C_L = 100\text{ pF}$  (unless otherwise noted)

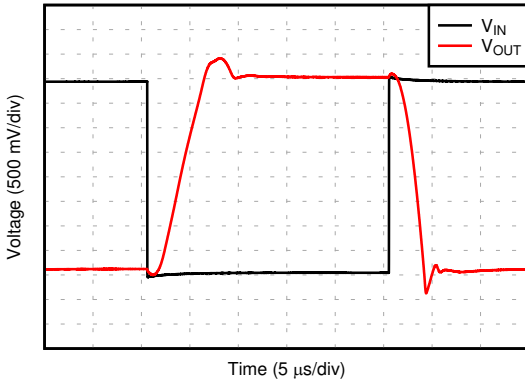

C014

$G = -1$

Figure 6-37. Large-Signal Step Response (4-V Step)

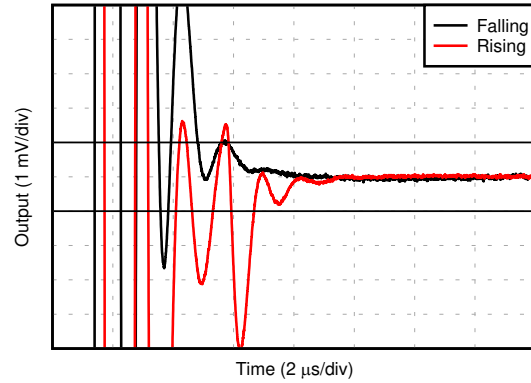

C033

Figure 6-38. Settling Time (1-V Positive Step)

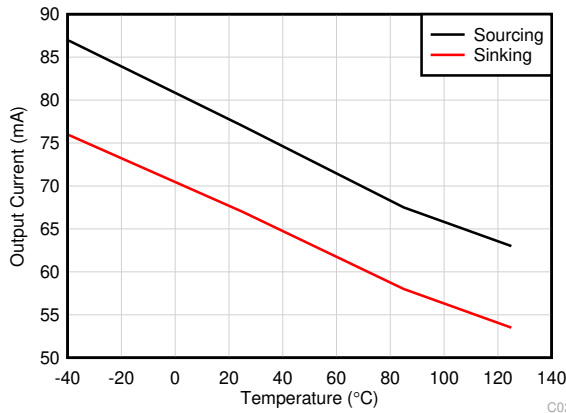

C026

Figure 6-39. Short-Circuit Current vs Temperature

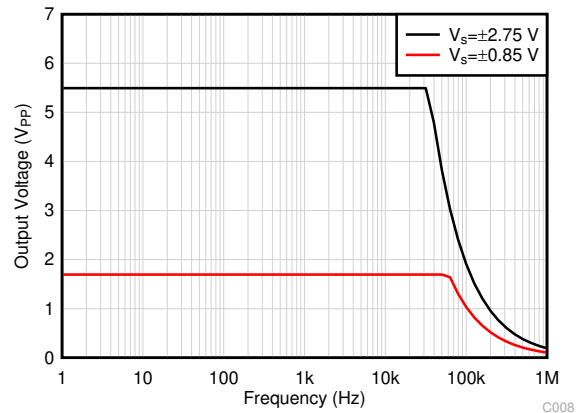

C008

Figure 6-40. Maximum Output Voltage vs Frequency

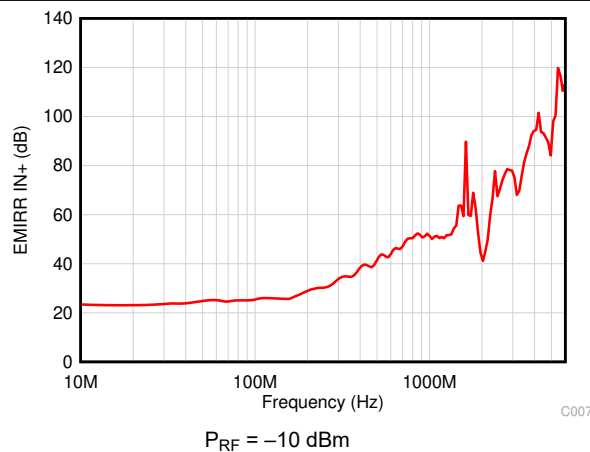

C007

$P_{RF} = -10\text{ dBm}$

Figure 6-41. EMIRR vs Frequency

## 7 Detailed Description

### 7.1 Overview

The OPA396 is a low-offset, low-power e-trim operational amplifier (op amp) that uses a proprietary offset trim technique. This op amp offers ultra-low input offset voltage, drift and input bias current while achieving an excellent bandwidth-to-quiescent-current ratio. The OPA396 operates from 1.7 V to 5.5 V, is unity-gain stable, and is designed for a wide range of general-purpose and precision applications.

The output features an advanced output stage that tolerates high capacitive loading for solid and stable performance. The OPA396 strengths make this device an excellent amplifier for high-impedance sensors, where input bias current, offset voltage, and power consumption are critical.

### 7.2 Functional Block Diagram

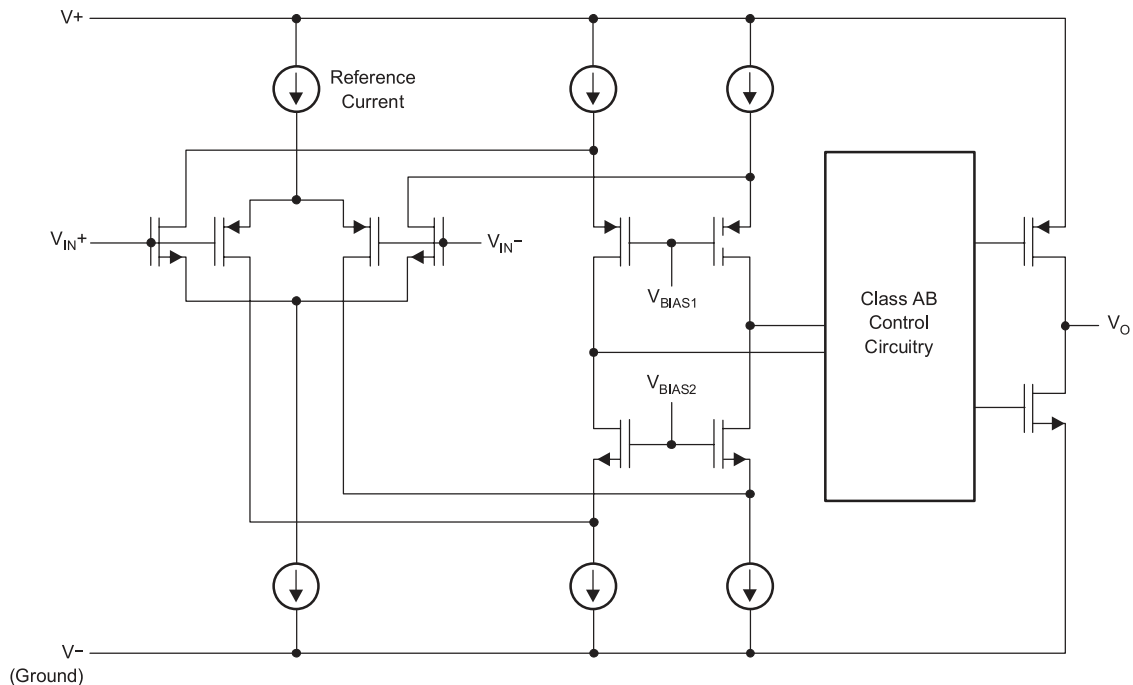

## 7.3 Feature Description

### 7.3.1 Low Input Bias Current

The OPA396 achieves very low input bias current as a result of CMOS inputs and advanced ESD protection circuitry. Input bias current ( $I_B$ ) is primarily a function of the input protection scheme in CMOS input amplifiers. If careful consideration is not taken with the ESD cells, a CMOS input device can exhibit large input bias currents, especially over temperature. The OPA396 achieves excellent input bias current ratings of  $\pm 30$  pA maximum at  $125^\circ\text{C}$ .

### 7.3.2 Input Differential Voltage

The OPA396 does not have any diodes connected between the input nodes, allowing for input voltages anywhere between the supply voltage. The input structure can be seen in [Figure 7-1](#). Although the device can tolerate any differential input voltage that does not exceed the supply voltage, do not operate continuously at differential input voltages greater than 0.5 V.

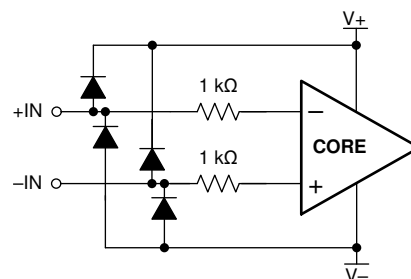

**Figure 7-1. Equivalent Input Circuit**

### 7.3.3 Capacitive Load Drive

The OPA396 features advanced output drive circuitry that can maintain stability even with capacitive loads as high as 1 nF. Many low-quiescent-current amplifiers exhibit poor stability when connected to a capacitive load as a result of the low levels of current used to bias the output stage. The OPA396 is designed with an output stage that adapts to high capacitive loads without sacrificing additional current consumption. This feature gives a highly stable device across all temperature and supply conditions, enabling robust system performance.

### 7.3.4 EMI Rejection

The OPA396 uses integrated electromagnetic interference (EMI) filtering to reduce the effects of EMI interference from sources such as wireless communications and densely-populated boards with a mix of analog signal chain and digital components. EMI immunity can be improved with circuit design techniques; the OPA396 benefits from these design improvements. Texas Instruments has developed the ability to accurately measure and quantify the immunity of an operational amplifier over a broad frequency spectrum extending from 10 MHz to 6 GHz. [Figure 7-2](#) shows the results of this testing on the OPA396. [Table 7-1](#) lists the EMIRR +IN values for the OPA396 at particular frequencies commonly encountered in real-world applications. Applications listed in [Table 7-1](#) may be centered on or operated near the particular frequency shown. Detailed information can also be found in the [EMI Rejection Ratio of Operational Amplifiers application report](#), available for download from [www.ti.com](http://www.ti.com).

The electromagnetic interference (EMI) rejection ratio, or EMIRR, describes the EMI immunity of operational amplifiers. An adverse effect that is common to many op amps is a change in the offset voltage as a result of RF signal rectification. An op amp that is more efficient at rejecting this change in offset as a result of EMI has a higher EMIRR and is quantified by a decibel value. Measuring EMIRR can be performed in many ways, but this section provides the EMIRR +IN, which specifically describes the EMIRR performance when the RF signal is applied to the noninverting input pin of the op amp. In general, only the noninverting input is tested for EMIRR for the following three reasons:

1. Op amp input pins are known to be the most sensitive to EMI, and typically rectify RF signals better than the supply or output pins.
2. The noninverting and inverting op amp inputs have symmetrical physical layouts and exhibit nearly matching EMIRR performance.
3. EMIRR is more simple to measure on noninverting pins than on other pins because the noninverting input terminal can be isolated on a PCB. This isolation allows the RF signal to be applied directly to the noninverting input terminal with no complex interactions from other components or connecting PCB traces.

High-frequency signals conducted or radiated to any pin of the operational amplifier may result in adverse effects because the amplifier does not have sufficient loop gain to correct for signals with spectral content outside the bandwidth. Conducted or radiated EMI on inputs, power supply, or output may result in unexpected dc offsets, transient voltages, or other unknown behavior. Make sure to properly shield and isolate sensitive analog nodes from noisy radio signals, digital clocks, and interfaces.

The EMIRR +IN of the OPA396 is plotted versus frequency as shown in [Figure 7-2](#). The OPA396 unity-gain bandwidth is 1 MHz. EMIRR performance less than this frequency denotes interfering signals that fall within the op amp bandwidth.

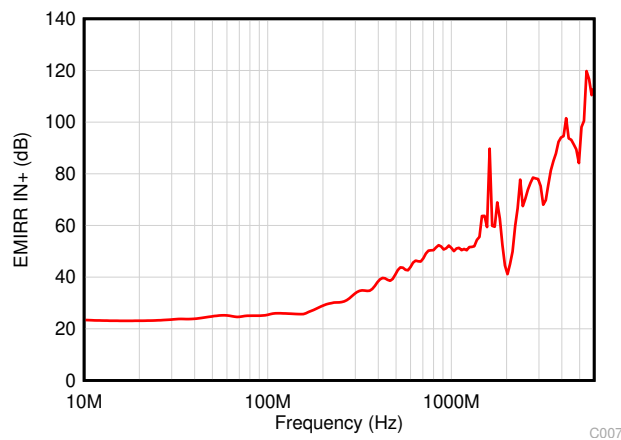

**Figure 7-2. EMIRR Testing**

**Table 7-1. OPA396 EMIRR IN+ for Frequencies of Interest**

FREQUENCY	APPLICATION AND ALLOCATION	EMIRR IN+
400 MHz	Mobile radio, mobile satellite, space operation, weather, radar, ultra-high frequency (UHF) applications	39.1 dB
900 MHz	Global system for mobile communications (GSM) applications, radio communication, navigation, GPS (to 1.6 GHz), GSM, aeronautical mobile, UHF applications	46.5 dB
1.8 GHz	GSM applications, mobile personal communications, broadband, satellite, L-band (1 GHz to 2 GHz)	61.3 dB
2.4 GHz	802.11b, 802.11g, 802.11n, Bluetooth®, mobile personal communications, industrial, scientific and medical (ISM) radio band, amateur radio and satellite, S-band (2 GHz to 4 GHz)	69.8 dB
3.6 GHz	Radiolocation, aero communication and navigation, satellite, mobile, S-band	82.5 dB
5 GHz	802.11a, 802.11n, aero communication and navigation, mobile communication, space and satellite operation, C-band (4 GHz to 8 GHz)	83.6 dB

## 7.4 Device Functional Modes

The OPA396 has a single functional mode and is operational when the power-supply voltage is greater than 1.7 V ( $\pm 0.85$  V). The maximum specified power-supply voltage for the OPA396 is 5.5 V ( $\pm 2.75$  V).



## 8 Application and Implementation

### Note

Information in the following applications sections is not part of the TI component specification, and TI does not warrant its accuracy or completeness. TI's customers are responsible for determining suitability of components for their purposes, as well as validating and testing their design implementation to confirm system functionality.

### 8.1 Application Information

The OPA396 is a unity-gain stable, precision operational amplifier free from unexpected output and phase reversal. The OPA396 is optimized for full rail-to-rail input, allowing for low-voltage, single-supply operation or split-supply use. These miniature, high-precision, low-noise amplifiers offer high-impedance inputs that have a common-mode range 100 mV beyond the supplies and can tolerate the full supply voltage across the input. The OPA396 precision amplifier is designed for sensor amplification, low-power analog signal chain applications in low or high gains, as well as a low-power discrete MOSFET or bipolar driver.

### 8.2 Typical Applications

#### 8.2.1 Three-Terminal CO Gas Sensor

Figure 8-1 shows a simple micropower potentiostat circuit for use with three-terminal unbiased CO sensors. This same design is applicable to many other type of three-terminal gas sensors or electrochemical cells. The basic sensor has three electrodes: the sense or working electrode (WE), counter electrode (CE) and reference electrode (RE). A current flows between CE and WE proportional to the detected concentration. The RE monitors the potential of the internal reference point. For an unbiased sensor, the WE and RE must be maintained at the same potential by adjusting the bias on CE. Through the potentiostat circuit formed by U1, the servo feedback action maintains the RE pin at a potential set by  $V_{REF}$ . R1 maintains stability as a result of the large capacitance of the sensor. C1 and R2 form the potentiostat integrator and set the feedback time constant. U2 forms a transimpedance amplifier (TIA) to convert the resulting sensor current into a proportional voltage. The transimpedance gain, and resulting sensitivity, is set by  $R_F$  according to Equation 1:

$$V_{TIA} = (-I * R_F) + V_{REF} \quad (1)$$

$R_{LOAD}$  is a load resistor with a value that is normally specified by the sensor manufacturer (typically, 10  $\Omega$ ). The potential at WE is set by the applied  $V_{REF}$ .

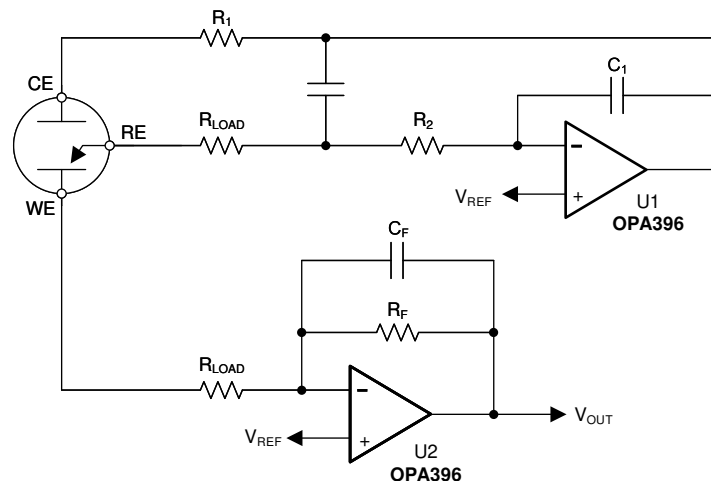
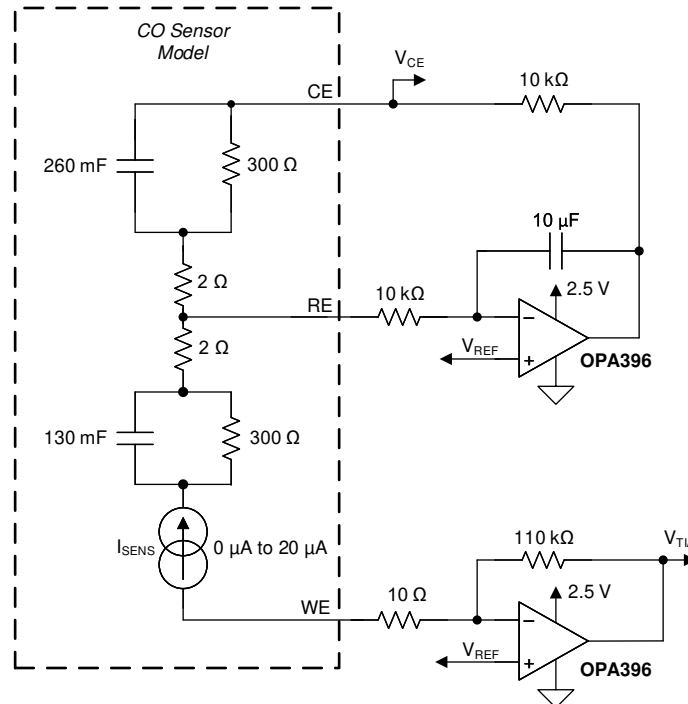

Figure 8-1. Three-Terminal CO Gas Sensor

### 8.2.1.1 Design Requirements

For this example, an electrical model of a CO sensor is used to simulate the sensor performance, as shown in Figure 8-2. The simulation is designed to model a CO sensor with a sensitivity of 69 nA/ppm. The supply voltage and maximum analog-to-digital converter (ADC) input voltage is 2.5 V, and the maximum concentration is 300 ppm.



**Figure 8-2. CO Sensor Simulation Schematic**

### 8.2.1.2 Detailed Design Procedure

First, determine the  $V_{REF}$  voltage. This voltage is a compromise between maximum headroom and resolution, as well as allowance for the minimum swing on the CE terminal because the CE terminal generally goes negative in relation to the RE potential as the concentration (sensor current) increases. Bench measurements found the difference between CE and RE to be 180 mV at 300 ppm for this particular sensor. To allow for negative CE swing, footroom, and voltage drop across the 10-kΩ resistor, 300 mV is chosen for  $V_{REF}$ .

$$V_{ZERO} = V_{REF} = 300 \text{ mV} \quad (2)$$

where

- $V_{REF}$  is the reference voltage (300 mV).
- $V_{ZERO}$  is the concentration voltage (300 mV).

Next, calculate the maximum sensor current at highest expected concentration:

$$I_{SENSMAX} = I_{PERPPM} * \text{ppmMAX} = 69 \text{ nA} * 300 \text{ ppm} = 20.7 \text{ } \mu\text{A} \quad (3)$$

where

- $I_{SENSMAX}$  is the maximum expected sensor current.
- $I_{PERPPM}$  is the manufacturer specified sensor current in amperes per ppm.
- $\text{ppmMAX}$  is the maximum required ppm reading.

Then, find the available output swing range greater than the reference voltage available for the measurement:

$$V_{\text{SWING}} = V_{\text{OUTMAX}} - V_{\text{ZERO}} = 2.5 \text{ V} - 0.3 \text{ V} = 2.2 \text{ V} \quad (4)$$

where

- $V_{\text{SWING}}$  is the expected change in output voltage.
- $V_{\text{OUTMAX}}$  is the maximum amplifier output swing.

Finally, calculate the transimpedance resistor ( $R_F$ ) value using the maximum swing and the maximum sensor current:

$$R_F = V_{\text{SWING}} / I_{\text{SENSMAX}} = 2.2 \text{ V} / 20.7 \mu\text{A} = 106.28 \text{ k}\Omega \text{ (use } 110 \text{ k}\Omega \text{ for a common value)} \quad (5)$$

### 8.2.1.3 Application Curve

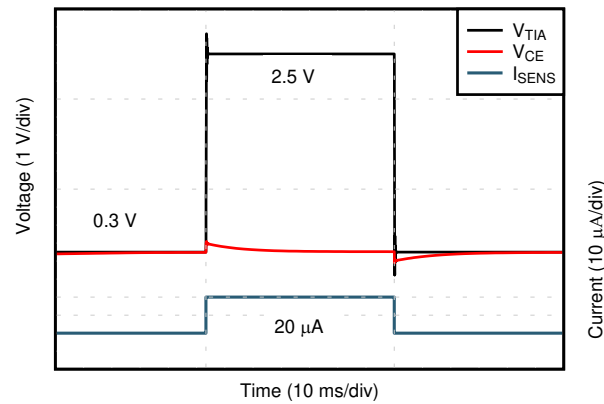

C012

**Figure 8-3. Sensor Transient Response to Simulated 300-ppm CO Exposure**

### 8.2.2 4-mA to 20-mA Loop Design

Factory automation systems commonly use the 4-mA to 20-mA (4-20 mA) communication protocol to enable process automation. In typical 2-wire, 4-mA to 20-mA loop applications, power to the remote transmitter is limited to less than 4 mA total consumption. As a result of the power limitations, low power consumption is essential. The OPA396 solves many design challenges in 4-mA to 20-mA loop applications, where low power, high accuracy, and high bandwidth are required.

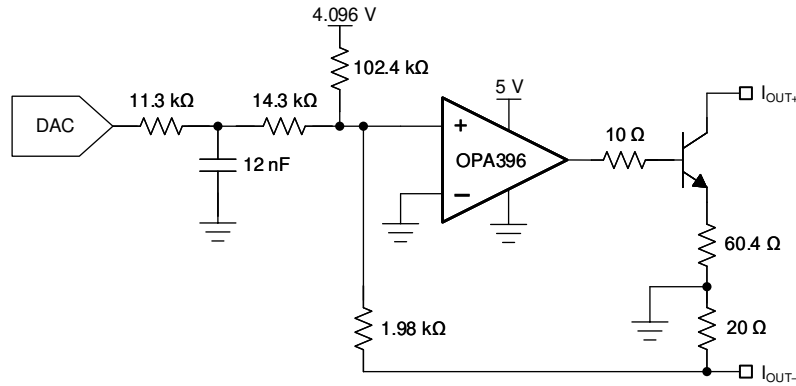

Figure 8-4. 4-20 mA Loop Interface Schematic

#### 8.2.2.1 Design Requirements

Table 8-1. Design Parameters

PARAMETER	VALUE
Total current consumption	< 100 $\mu$ A
DAC control voltage	0 V to 4.096 V
Output current	4 mA to 20 mA

#### 8.2.2.2 Application Curve

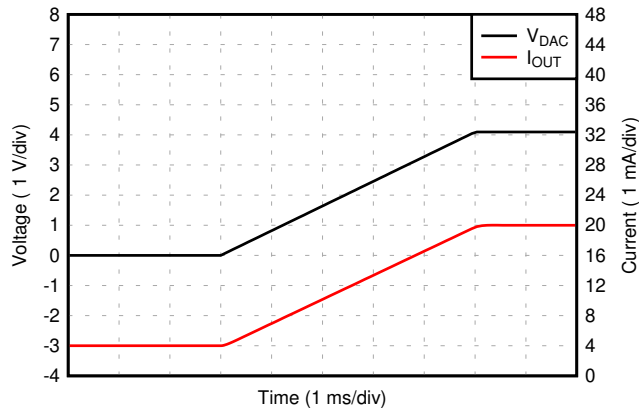

Figure 8-5. 4-mA to 20-mA Loop Response

## 9 Power Supply Recommendations

The OPA396 device is specified for operation from 1.7 V to 5.5 V ( $\pm 0.85$  V to  $\pm 2.75$  V).

## 10 Layout

### 10.1 Layout Guidelines

Paying attention to good layout practice is always recommended. Keep traces short, and when possible, use a printed-circuit board (PCB) ground plane with surface-mount components placed as close as possible to the device pins. Place a 0.1- $\mu$ F capacitor closely across the supply pins. These guidelines must be applied throughout the analog circuit to improve performance and provide benefits, such as reducing the electromagnetic interference (EMI) susceptibility.

### 10.2 Layout Example

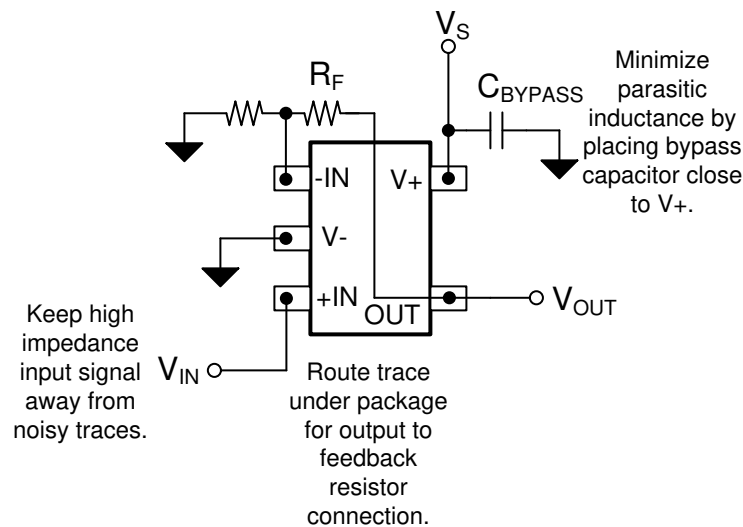

**Figure 10-1. OPA396 Layout Example**

## 11 Device and Documentation Support

### 11.1 Device Support

#### 11.1.1 Development Support

##### 11.1.1.1 TINA-TI™ Simulation Software (Free Download)

TINA-TI™ software is a simple, powerful, and easy-to-use circuit simulation program based on a SPICE engine. TINA-TI software is a free, fully-functional version of the TINA™ software, preloaded with a library of macromodels in addition to a range of both passive and active models. TINA-TI simulation software provides all the conventional dc, transient, and frequency domain analysis of SPICE, as well as additional design capabilities.

Available as a [free download](#) from the Analog eLab Design Center, TINA-TI software offers extensive post-processing capability that allows users to format results in a variety of ways. Virtual instruments offer the ability to select input waveforms and probe circuit nodes, voltages, and waveforms, creating a dynamic quick-start tool.

---

#### Note

These files require that either the TINA software (from DesignSoft™) or TINA-TI software be installed. Download the free TINA-TI software from the [TINA-TI website](#).

---

### 11.2 Documentation Support

#### 11.2.1 Related Documentation

For related documentation see the following:

- Texas Instruments, [Highly-Accurate, Loop-Powered, 4mA to 20mA Field Transmitter With HART Modem reference design](#)
- Texas Instruments, [Micropower Electrochemical Gas Sensor Amplifier reference design](#)
- Texas Instruments, [Compensate Transimpedance Amplifiers Intuitively application report](#)
- Texas Instruments, [Designing With pH Electrodes application report](#)

#### 11.3 Receiving Notification of Documentation Updates

To receive notification of documentation updates, navigate to the device product folder on [ti.com](#). Click on [Subscribe to updates](#) to register and receive a weekly digest of any product information that has changed. For change details, review the revision history included in any revised document.

#### 11.4 Support Resources

[TI E2E™ support forums](#) are an engineer's go-to source for fast, verified answers and design help — straight from the experts. Search existing answers or ask your own question to get the quick design help you need.

Linked content is provided "AS IS" by the respective contributors. They do not constitute TI specifications and do not necessarily reflect TI's views; see TI's [Terms of Use](#).

#### 11.5 Trademarks

e-trim™, TINA-TI™, and TI E2E™ are trademarks of Texas Instruments.

TINA™ and DesignSoft™ are trademarks of DesignSoft, Inc.

Bluetooth® is a registered trademark of Bluetooth SIG, Inc.

All trademarks are the property of their respective owners.

#### 11.6 Electrostatic Discharge Caution



This integrated circuit can be damaged by ESD. Texas Instruments recommends that all integrated circuits be handled with appropriate precautions. Failure to observe proper handling and installation procedures can cause damage.

ESD damage can range from subtle performance degradation to complete device failure. Precision integrated circuits may be more susceptible to damage because very small parametric changes could cause the device not to meet its published specifications.

## 11.7 Glossary

[TI Glossary](#) This glossary lists and explains terms, acronyms, and definitions.

## 12 Mechanical, Packaging, and Orderable Information

The following pages include mechanical packaging and orderable information. This information is the most current data available for the designated devices. This data is subject to change without notice and revision of this document. For browser-based versions of this data sheet, refer to the left-hand navigation.

**PACKAGING INFORMATION**

Orderable Device	Status (1)	Package Type	Package Drawing	Pins	Package Qty	Eco Plan (2)	Lead finish/ Ball material (6)	MSL Peak Temp (3)	Op Temp (°C)	Device Marking (4/5)	Samples
OPA396DCKR	ACTIVE	SC70	DCK	5	3000	RoHS & Green	NIPDAU	Level-2-260C-1 YEAR	-40 to 125	1JJ	<a href="#">Samples</a>
OPA396DCKT	ACTIVE	SC70	DCK	5	250	RoHS & Green	NIPDAU	Level-2-260C-1 YEAR	-40 to 125	1JJ	<a href="#">Samples</a>

(1) The marketing status values are defined as follows:

**ACTIVE:** Product device recommended for new designs.

**LIFEBUY:** TI has announced that the device will be discontinued, and a lifetime-buy period is in effect.

**NRND:** Not recommended for new designs. Device is in production to support existing customers, but TI does not recommend using this part in a new design.

**PREVIEW:** Device has been announced but is not in production. Samples may or may not be available.

**OBSELETE:** TI has discontinued the production of the device.

(2) **RoHS:** TI defines "RoHS" to mean semiconductor products that are compliant with the current EU RoHS requirements for all 10 RoHS substances, including the requirement that RoHS substance do not exceed 0.1% by weight in homogeneous materials. Where designed to be soldered at high temperatures, "RoHS" products are suitable for use in specified lead-free processes. TI may reference these types of products as "Pb-Free".

**RoHS Exempt:** TI defines "RoHS Exempt" to mean products that contain lead but are compliant with EU RoHS pursuant to a specific EU RoHS exemption.

**Green:** TI defines "Green" to mean the content of Chlorine (Cl) and Bromine (Br) based flame retardants meet JS709B low halogen requirements of <=1000ppm threshold. Antimony trioxide based flame retardants must also meet the <=1000ppm threshold requirement.

(3) MSL, Peak Temp. - The Moisture Sensitivity Level rating according to the JEDEC industry standard classifications, and peak solder temperature.

(4) There may be additional marking, which relates to the logo, the lot trace code information, or the environmental category on the device.

(5) Multiple Device Markings will be inside parentheses. Only one Device Marking contained in parentheses and separated by a "~" will appear on a device. If a line is indented then it is a continuation of the previous line and the two combined represent the entire Device Marking for that device.

(6) Lead finish/Ball material - Orderable Devices may have multiple material finish options. Finish options are separated by a vertical ruled line. Lead finish/Ball material values may wrap to two lines if the finish value exceeds the maximum column width.

**Important Information and Disclaimer:**The information provided on this page represents TI's knowledge and belief as of the date that it is provided. TI bases its knowledge and belief on information provided by third parties, and makes no representation or warranty as to the accuracy of such information. Efforts are underway to better integrate information from third parties. TI has taken and continues to take reasonable steps to provide representative and accurate information but may not have conducted destructive testing or chemical analysis on incoming materials and chemicals. TI and TI suppliers consider certain information to be proprietary, and thus CAS numbers and other limited information may not be available for release.

In no event shall TI's liability arising out of such information exceed the total purchase price of the TI part(s) at issue in this document sold by TI to Customer on an annual basis.



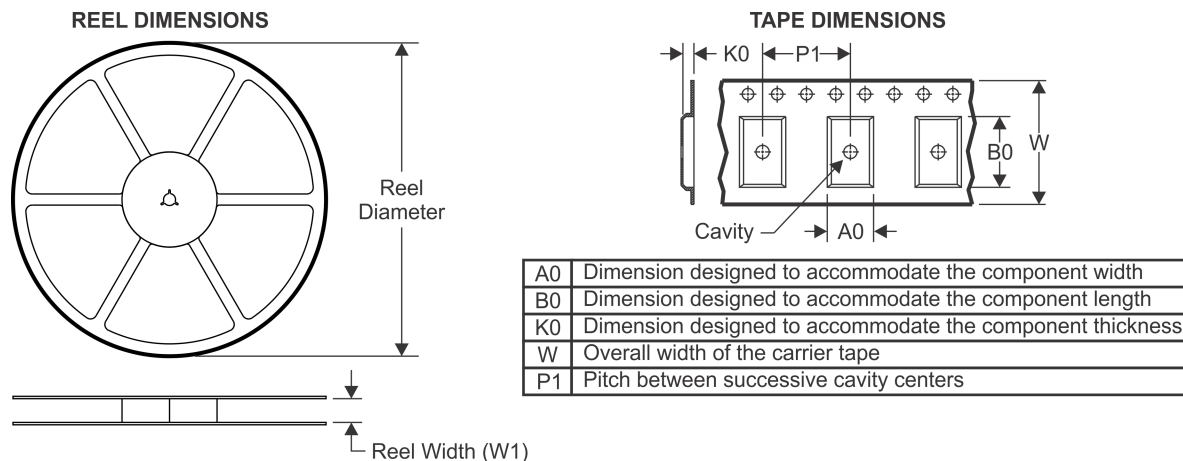

**TAPE AND REEL INFORMATION**

**QUADRANT ASSIGNMENTS FOR PIN 1 ORIENTATION IN TAPE**

\*All dimensions are nominal

Device	Package Type	Package Drawing	Pins	SPQ	Reel Diameter (mm)	Reel Width W1 (mm)	A0 (mm)	B0 (mm)	K0 (mm)	P1 (mm)	W (mm)	Pin1 Quadrant
OPA396DCKR	SC70	DCK	5	3000	178.0	9.0	2.4	2.5	1.2	4.0	8.0	Q3
OPA396DCKT	SC70	DCK	5	250	178.0	9.0	2.4	2.5	1.2	4.0	8.0	Q3

**TAPE AND REEL BOX DIMENSIONS**

\*All dimensions are nominal

Device	Package Type	Package Drawing	Pins	SPQ	Length (mm)	Width (mm)	Height (mm)
OPA396DCKR	SC70	DCK	5	3000	190.0	190.0	30.0
OPA396DCKT	SC70	DCK	5	250	190.0	190.0	30.0



# EXAMPLE BOARD LAYOUT

DCK0005A

SOT - 1.1 max height

SMALL OUTLINE TRANSISTOR

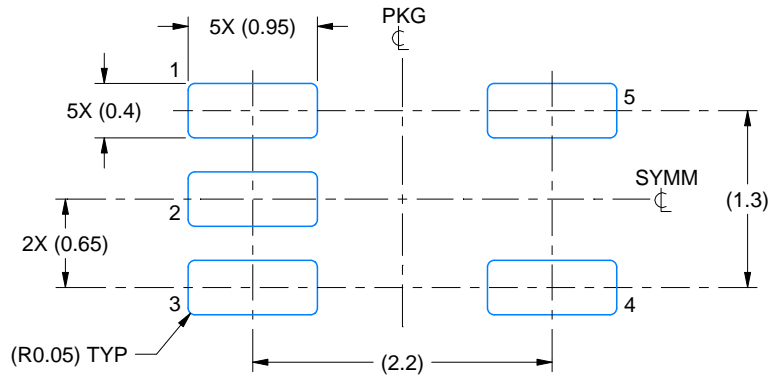

LAND PATTERN EXAMPLE  
EXPOSED METAL SHOWN  
SCALE:18X

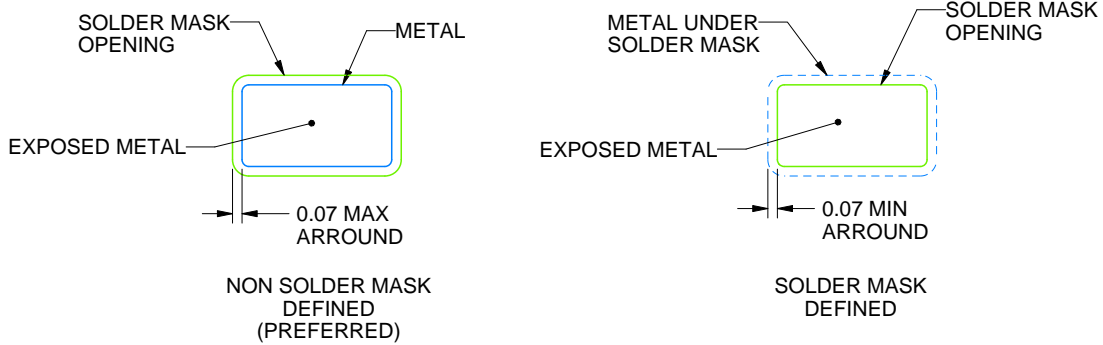

SOLDER MASK DETAILS

4214834/E 06/2024

NOTES: (continued)

- 7. Publication IPC-7351 may have alternate designs.
- 8. Solder mask tolerances between and around signal pads can vary based on board fabrication site.

# EXAMPLE STENCIL DESIGN

DCK0005A

SOT - 1.1 max height

SMALL OUTLINE TRANSISTOR

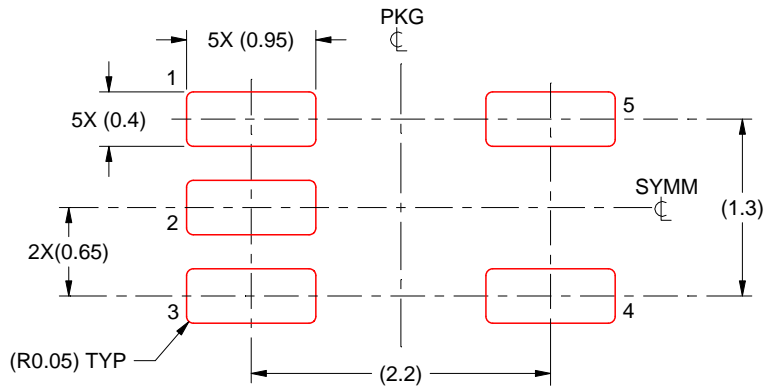

SOLDER PASTE EXAMPLE  
BASED ON 0.125 THICK STENCIL  
SCALE: 18X

4214834/E 06/2024

NOTES: (continued)

9. Laser cutting apertures with trapezoidal walls and rounded corners may offer better paste release. IPC-7525 may have alternate design recommendations.
10. Board assembly site may have different recommendations for stencil design.

## IMPORTANT NOTICE AND DISCLAIMER

TI PROVIDES TECHNICAL AND RELIABILITY DATA (INCLUDING DATA SHEETS), DESIGN RESOURCES (INCLUDING REFERENCE DESIGNS), APPLICATION OR OTHER DESIGN ADVICE, WEB TOOLS, SAFETY INFORMATION, AND OTHER RESOURCES "AS IS" AND WITH ALL FAULTS, AND DISCLAIMS ALL WARRANTIES, EXPRESS AND IMPLIED, INCLUDING WITHOUT LIMITATION ANY IMPLIED WARRANTIES OF MERCHANTABILITY, FITNESS FOR A PARTICULAR PURPOSE OR NON-INFRINGEMENT OF THIRD PARTY INTELLECTUAL PROPERTY RIGHTS.

These resources are intended for skilled developers designing with TI products. You are solely responsible for (1) selecting the appropriate TI products for your application, (2) designing, validating and testing your application, and (3) ensuring your application meets applicable standards, and any other safety, security, regulatory or other requirements.

These resources are subject to change without notice. TI grants you permission to use these resources only for development of an application that uses the TI products described in the resource. Other reproduction and display of these resources is prohibited. No license is granted to any other TI intellectual property right or to any third party intellectual property right. TI disclaims responsibility for, and you will fully indemnify TI and its representatives against, any claims, damages, costs, losses, and liabilities arising out of your use of these resources.

TI's products are provided subject to [TI's Terms of Sale](#) or other applicable terms available either on [ti.com](https://www.ti.com) or provided in conjunction with such TI products. TI's provision of these resources does not expand or otherwise alter TI's applicable warranties or warranty disclaimers for TI products.

TI objects to and rejects any additional or different terms you may have proposed.

Mailing Address: Texas Instruments, Post Office Box 655303, Dallas, Texas 75265  
Copyright © 2024, Texas Instruments Incorporated