

DC TO 4-GBPS DUAL 1:2 MULTIPLEXER/REPEATER/EQUALIZER

FEATURES

- Receiver Equalization and Selectable Driver Preemphasis to Counteract High-Frequency Transmission Line Losses
- Integration of Two-Serial Port
- Selectable Loopback
- Typical Power Consumption 650 mW
- 30-ps Deterministic Jitter
- On-Chip 100- Ω Receiver and Driver Differential Termination Resistors Eliminate External Components and Reflection from Stubs
- 3.3-V Nominal Power Supply

- 48-Terminal QFN (Quad Flatpack) 7 mm \times 7 mm \times 1 mm, 0.5-mm Terminal Pitch
- Temperature Range: -40°C to 85°C

APPLICATIONS

- Bidirectional Link Replicator
- Signal Conditioner
- XAUI 802.3ae Protocol Backplane Redundancy
- Host Adapter (Applications With Internal and External Connection to SERDES)
- Signaling Rates DC to 4 Gbps Including XAUI, GbE, FC, HDTV

DESCRIPTION

The SN65LVCP40 is a signal conditioner and data multiplexer optimized for backplanes. Input equalization and programmable output preemphasis support data rates up to 4 Gbps. Common applications are redundancy switching, signal buffering, or performance improvements on legacy backplane hardware.

The SN65LVCP40 combines a pair of 1:2 buffers with a pair of 2:1 multiplexers (mux). Selectable switch-side loopback supports system testing. System interconnects and serial backplane applications of up to 4 Gbps are supported. Each of the two independent channels consists of a transmitter with a fan-out of two, and a receiver with a 2:1 input multiplexer.

The drivers provide four selectable levels of preemphasis to compensate for transmission line losses. The receivers incorporate receive equalization and compensates for input transmission line loss. This minimizes deterministic jitter in the link. The equalization is optimized to compensate for a FR-4 backplane trace with 5-dB, high-frequency loss between 375 MHz and 1.875 GHz. This corresponds to a 24-inch long FR-4 trace with 6-mil trace width.

This device operates from a single 3.3-V supply. The device has integrated 100- Ω line termination and provides self-biasing. The input tolerates most differential signaling levels such as LVDS, LVPECL or CML. The output impedance matches 100- Ω line impedance. The inputs and outputs may be ac coupled for best interconnectivity with other devices such as SERDES I/O or additional XAUI multiplexer buffer. With ac coupling, jitter is the lowest.

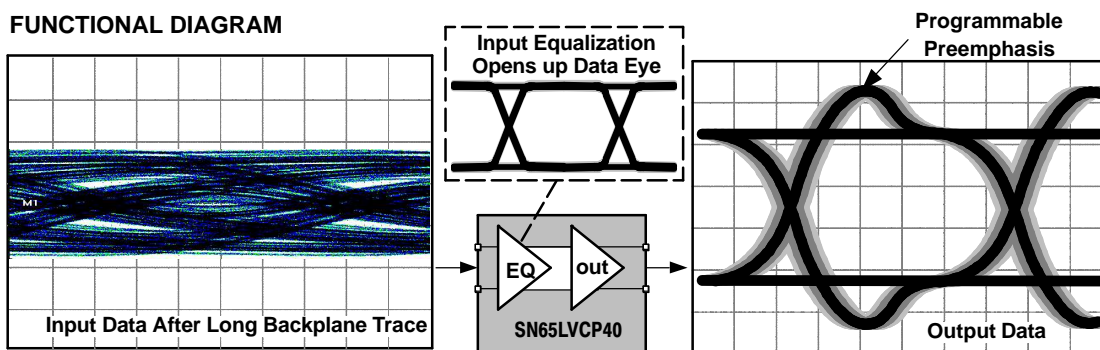

Please be aware that an important notice concerning availability, standard warranty, and use in critical applications of Texas Instruments semiconductor products and disclaimers thereto appears at the end of this data sheet.



These devices have limited built-in ESD protection. The leads should be shorted together or the device placed in conductive foam during storage or handling to prevent electrostatic damage to the MOS gates.

DESCRIPTION (CONTINUED)

The SN65LVCP40 is packaged in a 7 mm × 7 mm × 1 mm QFN (quad flatpack no-lead) lead-free package, and is characterized for operation from -40°C to 85°C.

AVAILABLE OPTIONS

T _A	DESCRIPTION	PACKAGED DEVICE ⁽¹⁾
		RGZ (48 pin)
-40°C to 85°C	Serial multiplexer	SN65LVCP40

(1) The package is available taped and reeled. Add an R suffix to device types (e.g., SN65LVCP40RGZR).

ABSOLUTE MAXIMUM RATINGS

over operating free-air temperature range (unless otherwise noted)⁽¹⁾

		UNIT
V _{CC}	Supply voltage range ⁽²⁾	-0.5 V to 6 V
Voltage range		Control inputs, all outputs
		Receiver inputs
ESD	Human Body Model ⁽³⁾	All pins
	Charged-Device Model ⁽⁴⁾	All pins
T _J	Maximum junction temperature	See Package Thermal Characteristics Table

- (1) Stresses beyond those listed under absolute maximum ratings may cause permanent damage to the device. These are stress ratings only and functional operation of the device at these or any other conditions beyond those indicated under recommended operating conditions is not implied. Exposure to absolute-maximum-rated conditions for extended periods may affect device reliability.
- (2) All voltage values, except differential I/O bus voltages, are with respect to network ground terminal.
- (3) Tested in accordance with JEDEC Standard 22, Test Method A114-A.
- (4) Tested in accordance with JEDEC Standard 22, Test Method C101.

PACKAGE THERMAL CHARACTERISTICS

PACKAGE THERMAL CHARACTERISTICS ⁽¹⁾		NOM	UNIT
θ _{JA} (junction-to-ambient)	4-layer JEDEC Board (JESD51-7) using eight GND-vias Ø-0.2 on the center pad as shown in the section: <i>Recommended pcb footprint</i> with boundary and environment conditions of JEDEC Board (JESD51-2)	33	°C/W
θ _{JB} (junction-to-board)		20	°C/W
θ _{JC} (junction-to-case)		23.6	°C/W
PSI-jt (junction-to-top pseudo)		0.6	°C/W
PSI-jb (junction-to-board pseudo)		19.4	°C/W
θ _{JP} (junction-to-pad)		5.4	°C/W

(1) See application note [SPRA953](http://www-s.ti.com/sc/psheets/spra953/spra953.pdf) for a detailed explanation of thermal parameters (<http://www-s.ti.com/sc/psheets/spra953/spra953.pdf>).

RECOMMENDED OPERATING CONDITIONS

		MIN	NOM	MAX	UNIT	
dR	Operating data rate			4	Gbps	
V _{CC}	Supply voltage	3.135	3.3	3.465	V	
V _{CC(N)}	Supply voltage noise amplitude	10 Hz to 2 GHz		20	mV	
T _J	Junction temperature			125	°C	
T _A	Operating free-air temperature ⁽¹⁾	-40		85	°C	
DIFFERENTIAL INPUTS						
V _{ID}	Receiver peak-to-peak differential input voltage ⁽²⁾	dR _(in) ≤ 1.25 Gbps		100	1750	mVpp
		1.25 Gbps < dR _(in) ≤ 3.125 Gbps		100	1560	mVpp
		dR _(in) > 3.125 Gbps		100	1000	mVpp
V _{ICM}	Receiver common-mode input voltage	Note: for best jitter performance ac coupling is recommended.		1.5	1.6 V _{CC} - $\frac{ V_{ID} }{2}$	V
CONTROL INPUTS						
V _{IH}	High-level input voltage	2		V _{CC} + 0.3	V	
V _{IL}	Low-level input voltage	-0.3		0.8	V	
DIFFERENTIAL OUTPUTS						
R _L	Differential load resistance	80	100	120	Ω	

(1) Maximum free-air temperature operation is allowed as long as the device maximum junction temperature is not exceeded.

(2) Differential input voltage V_{ID} is defined as |IN+ – IN–|.

ELECTRICAL CHARACTERISTICS

over operating free-air temperature range (unless otherwise noted)

PARAMETER	TEST CONDITIONS	MIN	TYP ⁽¹⁾	MAX	UNIT
DIFFERENTIAL INPUTS					
V _{IT+}	Positive going differential input high threshold			50	mV
V _{IT–}	Negative going differential input low threshold	-50			mV
A _(EQ)	Equalizer gain	From 375 MHz to 1.875 GHz		5	dB
R _{T(D)}	Termination resistance, differential	80	100	120	Ω
V _{BB}	Open-circuit Input voltage (input self-bias voltage)	AC-coupled inputs		1.6	V
R _(BBDC)	Biasing network dc impedance		30		kΩ
R _(BBAC)	Biasing network ac impedance	375 MHz	42		Ω
		1.875 GHz	8.4		
DIFFERENTIAL OUTPUTS					
V _{OH}	High-level output voltage	R _L = 100 Ω±1%, PRES_1 = PRES_0=0; PREL_1 = PREL_0=0; 4 Gbps alternating 1010-pattern; Figure 1		650	mVpp
V _{OL}	Low-level output voltage			-650	mVpp
V _{ODB(PP)}	Output differential voltage without preemphasis ⁽²⁾	1000	1300	1500	mVpp
V _{OCM}	Output common mode voltage		1.65		V
ΔV _{OC(SS)}	Change in steady-state common-mode output voltage between logic states	See Figure 6		1	mV

(1) All typical values are at T_A = 25°C and V_{CC} = 3.3 V supply unless otherwise noted. They are for reference purposes and are not production tested.

(2) Differential output voltage V_(ODB) is defined as |OUT+ – OUT–|.

ELECTRICAL CHARACTERISTICS (continued)

over operating free-air temperature range (unless otherwise noted)

PARAMETER		TEST CONDITIONS		MIN	TYP ⁽¹⁾	MAX	UNIT
$V_{(PE)}$	Output preemphasis voltage ratio, $\frac{V_{ODB(PP)}}{V_{ODPE(PP)}}$	$R_L = 100 \Omega \pm 1\%$; $x = L$ or S ; See Figure 1	PRE _{x_1} :PRE _{x_0} = 00		0		dB
			PRE _{x_1} :PRE _{x_0} = 01		3		
			PRE _{x_1} :PRE _{x_0} = 10		6		
			PRE _{x_1} :PRE _{x_0} = 11		9		
$t_{(PRE)}$	Preemphasis duration measurement	Output preemphasis is set to 9 dB during test PRE _{x_x} = 1; Measured with a 100-MHz clock signal; $R_L = 100 \Omega, \pm 1\%$, See Figure 2			175		ps
r_o	Output resistance	Differential on-chip termination between OUT+ and OUT–			100		Ω
CONTROL INPUTS							
I_{IH}	High-level Input current	VIN = VCC				5	μA
I_{IL}	Low-level Input current	VIN = GND			90	125	μA
$R_{(PU)}$	Pullup resistance				35		k Ω
POWER CONSUMPTION							
P_D	Device power dissipation	All outputs terminated 100 Ω			650	880	mW
I_{CC}	Device current consumption	All outputs terminated 100 Ω	PRBS 2 ⁷ -1 pattern at 4 Gbps			254	mA

SWITCHING CHARACTERISTICS

over operating free-air temperature range (unless otherwise noted)

PARAMETER		TEST CONDITIONS		MIN	TYP ⁽¹⁾	MAX	UNIT
MULTIPLEXER							
$t_{(SM)}$	Multiplexer switch time	Multiplexer or loopback control to valid output			3	6	ns
DIFFERENTIAL OUTPUTS							
t_{PLH}	Low-to-high propagation delay	Propagation delay input to output See Figure 4			0.5	1	ns
t_{PHL}	High-to-low propagation delay				0.5	1	ns
t_r	Rise time	20% to 80% of $V_{O(DB)}$; Test Pattern: 100-MHz clock signal; See Figure 3 and Figure 7			80		ps
t_f	Fall time				80		ps
$t_{sk(p)}$	Pulse skew, $ t_{PHL} - t_{PLH} $ ⁽²⁾					20	ps
$t_{sk(o)}$	Output skew ⁽³⁾	All outputs terminated with 100 Ω			25	200	ps
$t_{sk(pp)}$	Part-to-part skew ⁽⁴⁾					500	ps
RJ	Device random jitter, rms	See Figure 7 for test circuit. BERT setting 10 ⁻¹⁵ Alternating 10-pattern.			0.8	2	ps-rms

(1) All typical values are at 25°C and with 3.3 V supply unless otherwise noted.

(2) $t_{sk(p)}$ is the magnitude of the time difference between the t_{PLH} and t_{PHL} of any output of a single device.(3) $t_{sk(o)}$ is the magnitude of the time difference between the t_{PLH} and t_{PHL} of any two outputs of a single device.(4) $t_{sk(pp)}$ is the magnitude of the difference in propagation delay times between any specified terminals of two devices when both devices operate with the same supply voltages, at the same temperature, and have identical packages and test circuits.

SWITCHING CHARACTERISTICS (continued)

over operating free-air temperature range (unless otherwise noted)

PARAMETER		TEST CONDITIONS		MIN	TYP ⁽¹⁾	MAX	UNIT
DJ	Intrinsic deterministic device jitter ⁽⁵⁾⁽⁶⁾ , peak-to-peak	0 dB preemphasis (PRE _x = 0); See Figure 7 for the test circuit.	PRBS 2 ⁷⁻¹ pattern			30	ps
	Absolute deterministic output jitter ⁽⁷⁾ , peak-to-peak	0 dB preemphasis (PRE _x = 0); See Figure 7 for the test circuit.	PRBS 2 ⁷⁻¹ pattern		7		ps
					20		ps

- (5) Intrinsic deterministic device jitter is a measurement of the deterministic jitter contribution from the device. It is derived by the equation $(DJ_{(OUT)} - DJ_{(IN)})$, where $DJ_{(OUT)}$ is the total peak-to-peak deterministic jitter measured at the output of the device in pspp. $DJ_{(IN)}$ is the peak-to-peak deterministic jitter of the pattern generator driving the device.
- (6) The SN65LVCP40 built-in passive input equalizer compensates for ISI. For a 20-inch FR4 transmission line with 8-mil trace width, the LVCP40 typically reduces jitter by 60 ps from the device input to the device output.
- (7) Absolute deterministic output jitter reflects the deterministic jitter measured at the SN65LVCP40 output. The value is a real measured value with a Bit error tester as described in Figure 7. The absolute DJ reflects the sum of all deterministic jitter components accumulated over the link: $DJ_{(absolute)} = DJ_{(signal\ generator)} + DJ_{(transmission\ line)} + DJ_{(intrinsic(LVCP40))}$.

PIN ASSIGNMENTS

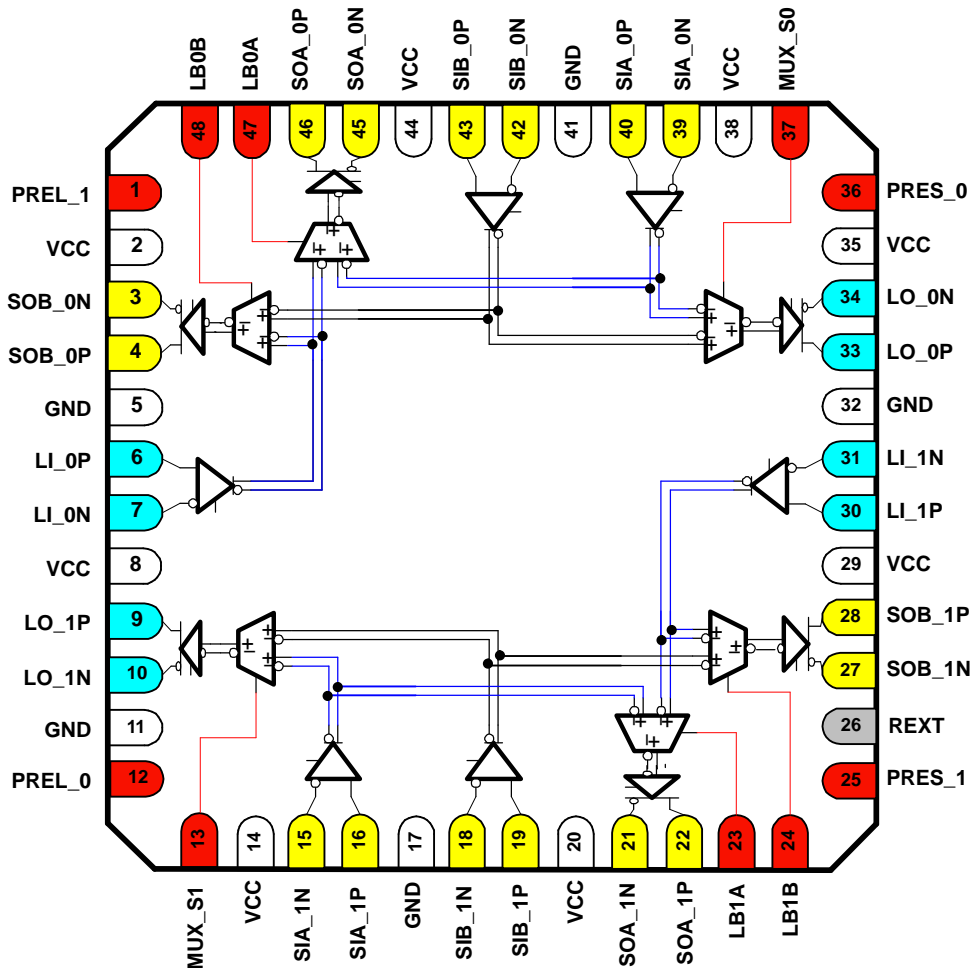
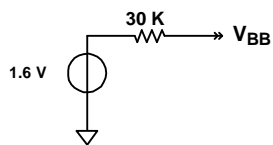
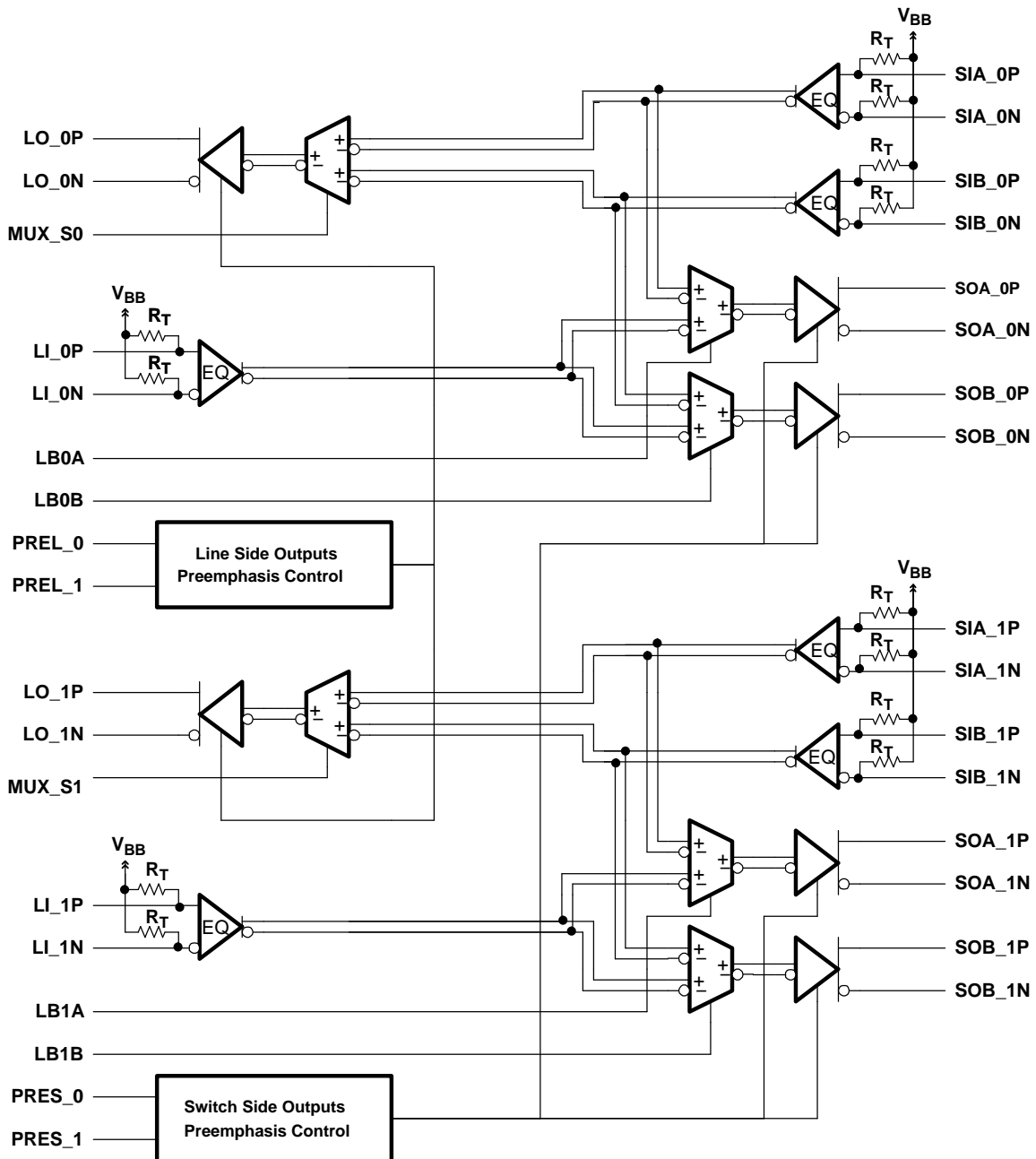

Table 1. Signal Descriptions

SIGNAL	PIN(S)	TYPE	SIGNAL TYPE	DESCRIPTION
LINE SIDE HIGH-SPEED I/O				
LI_0P LI_0N	6 7	I (w/ 50-Ω termination to VBB)	PECL/CML compatible	Differential input, port_0 line side
LI_1P LI_1N	30 31	I (w/ 50-Ω termination to VBB)	PECL/CML compatible	Differential input, port_1 line side
LO_0P LO_0N	33 34	O	VML ⁽¹⁾	Differential output, port_0 line side
LO_1P LO_1N	9 10	O	VML ⁽¹⁾	Differential output, port_1 line side
SWITCH SIDE HIGH-SPEED I/O				
SIA_0P SIA_0N	40 39	I (w/ 50-Ω termination to VBB)	CML/PECL compatible	Differential input, mux_0 switch_A_side
SIB_0P SIB_0N	43 42	I (w/ 50-Ω termination to VBB)	CML/PECL compatible	Differential input, mux_0 switch_B_side
SIA_1P SIA_1N	16 15	I (w/ 50-Ω termination to VBB)	CML/PECL compatible	Differential input, mux_1 switch_A_side
SIB_1P SIB_1N	19 18	I (w/ 50-Ω termination to VBB)	CML/PECL compatible	Differential input, mux_1 switch_B_side
SOA_0P SOA_0N	46 45	O	VML ⁽¹⁾	Differential output, mux_0 switch_A_side
SOB_0P SOB_0N	4 3	O	VML ⁽¹⁾	Differential output, mux_0 switch_B_side
SOA_1P SOA_1N	22 21	O	VML ⁽¹⁾	Differential output, mux_1 switch_A_side
SOB_1P SOB_1N	28 27	O	VML ⁽¹⁾	Differential output, mux_1 switch_B_side
CONTROL SIGNALS				
PREL_0 PREL_1	12 1	I (w/ 35-kΩ pullup)	LVTTTL	Output preemphasis control, line side port_0 and port_1. Has internal pull-up. See Preemphasis Controls PREL_0, PREL_1, PRES_0 and PRES for function definition.
PRES_0 PRES_1	36 25	I (w/ 35-kΩ pullup)	LVTTTL	Output preemphasis control, switch side port_0 and port_1. See Preemphasis Controls PREL_0, PREL_1, PRES_0 and PRES for function definition.
LB0A LB0B	47 48	I (w/ 35-kΩ pullup)	LVTTTL	Loopback control for mux_0 switch side. See Loopback Controls LB0A, LB0B, LB1A and LB1B for function definition.
LB1A LB1B	23 24	I (w/ 35-kΩ pullup)	LVTTTL	Loopback control for mux_1 switch side. See Loopback Controls LB0A, LB0B, LB1A and LB1B for function definition.
MUX_S0 MUX_S1	37 13	I (w/ 35-kΩ pullup)	LVTTTL	Port A and B multiplex control of mux_0 and mux_1. See Multiplex Controls MUX_S0 and MUX_S1 for function definition.
REXT	26		N/A	No connect. This pin is unused and can be left open or tied to GND with any resistor.
POWER SUPPLY				
VCC	2, 8, 14, 20, 29, 35, 38, 44	PWR		Power supply 3.3 V ±5%
GND	5, 11, 17, 32, 41	PWR		Power supply return
GND Center Pad		PWR		The ground center pad is the metal contact at the bottom of the 48-pin package. It must be connected to the GND plane. At least 4 vias are recommended to minimize inductance and provide a solid ground. See the package drawing for the via placement.

(1) VML stands for Voltage Mode logic; VML provides a differential output impedance of 100-Ω. VML offers the benefits of CML and consumes less power.

FUNCTIONAL BLOCK DIAGRAM



- Note:**
- V_{BB}:** Receiver input internal biasing voltage (allows ac coupling)
 - EQ:** Input Equalizer (compensates for frequency dependent transmission line loss of backplanes)
 - R_T:** Internal 50-Ohm receiver termination (100-Ohm differential)
- Preemphasis:** Output precompensation for transmission line losses

FUNCTIONAL DEFINITIONS

Table 2. Multiplex Controls MUX_S0 and MUX_S1

MUX_Sn ⁽¹⁾	MUX FUNCTION
0	MUX_n select input B
1	MUX_n select input A

(1) n = 0 or 1

Table 3. Loopback Controls LB0A, LB0B, LB1A and LB1B

LBnx ⁽¹⁾	LOOPBACK FUNCTION
0	Enable loopback of S _{lx} input to SO _x output
1	Disable loopback of S _{lx} input to SO _x output

(1) n = 0 or 1, x = A or B

Table 4. Multiplexer and Loopback Controls

INPUTS / OUTPUTS	SOA_0	SOB_0	SOA_1	SOB_1	LO_0	LO_1
SIA_0	LB0A = 0	x	x	x	MUX_S0 = 1	x
SIB_0	x	LB0B = 0	x	x	MUX_S0 = 0	x
SIA_1	x	x	LB1A = 0	x	x	MUX_S1 = 1
SIB_1	x	x	x	LB1B = 0	x	MUX_S1 = 0
LI_0	LB0A = 1	LB0B = 1	x	x	x	x
LI_1	x	x	LB1A = 1	LB1B = 1	x	x

Table 5. Preemphasis Controls PREL_0, PREL_1, PRES_0, and PRES_1

PREx_1 ⁽¹⁾	PREx_0 ⁽¹⁾	OUTPUT PREEMPHASIS LEVEL IN dB	OUTPUT LEVEL IN mVpp		TYPICAL FR4 TRACE LENGTH
			DEEMPHASIZED	PREEMPHASIZED	
0	0	0 dB	1200	1200	10 inches of FR4 trace
0	1	3 dB	850	1200	20 inches of FR4 trace
1	0	6 dB	600	1200	30 inches of FR4 trace
1	1	9 dB	425	1200	40 inches of FR4 trace

(1) x = L or S

Preemphasis is the primary signal conditioning mechanism. See [Figure 1](#) and [Figure 2](#) for further definition.

Equalization is secondary signal conditioning mechanism. The input stage provides 5-dB of fixed equalization gain from 375 MHz to 1.875 GHz (optimized for 3.75-Gbps 8B10B coded data).

PARAMETER MEASUREMENT INFORMATION

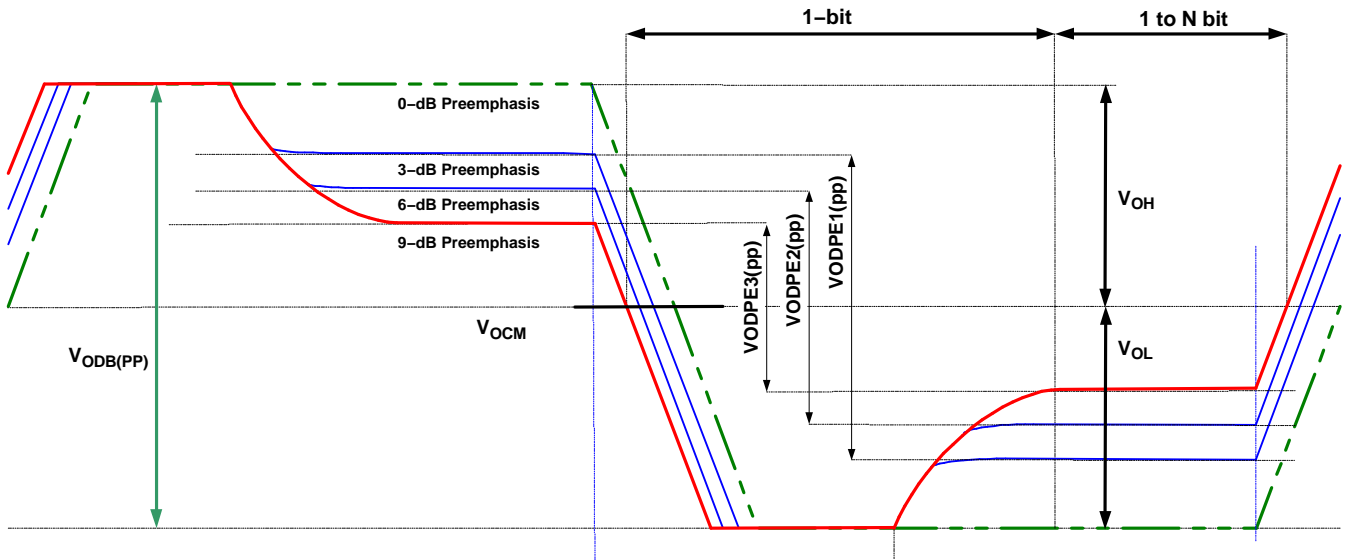

Figure 1. Preemphasis and Output Voltage Waveforms and Definitions

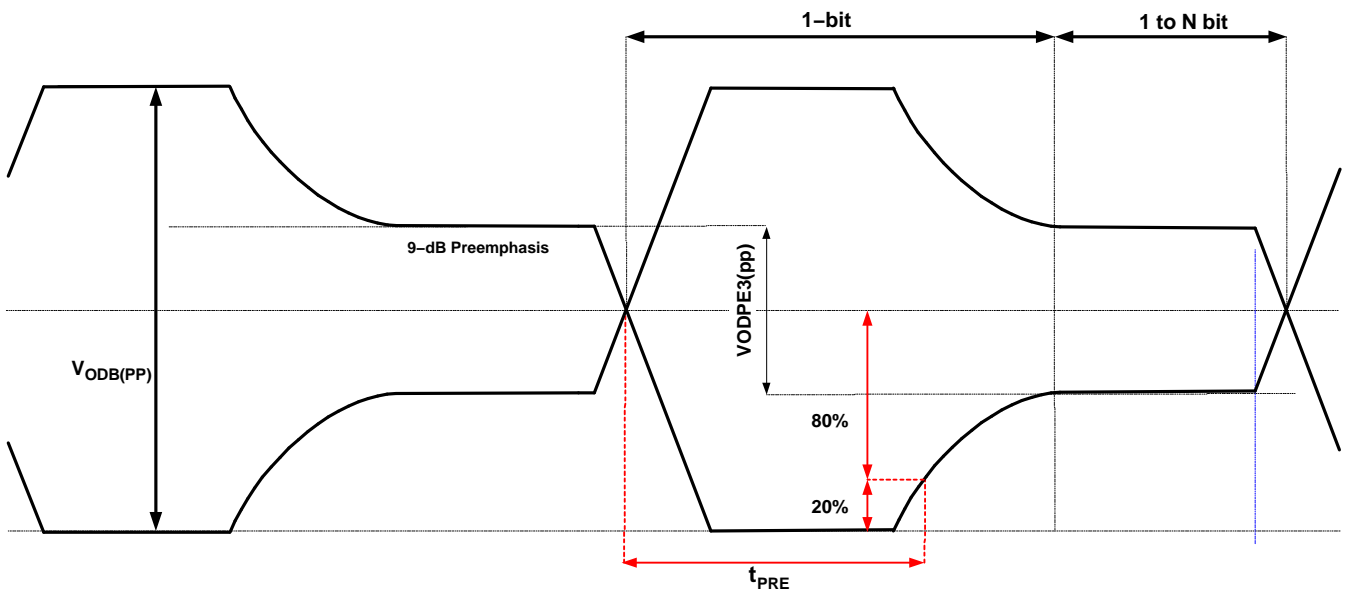

Figure 2. t_{PRE} Preemphasis Duration Measurement

PARAMETER MEASUREMENT INFORMATION (continued)

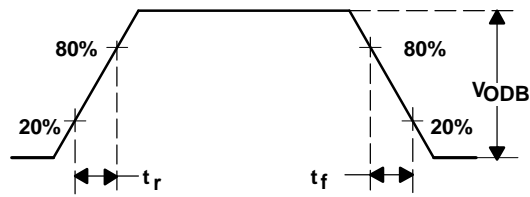

Figure 3. Driver Output Transition Time

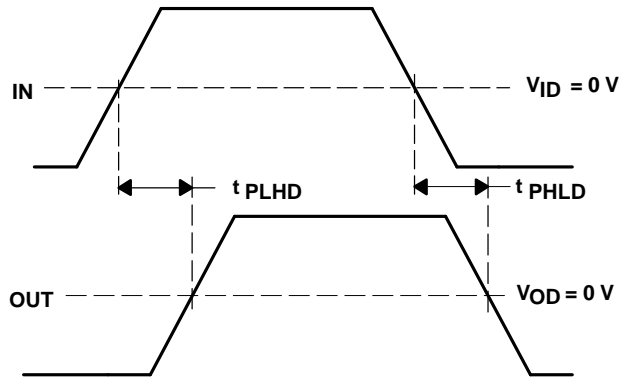

Figure 4. Propagation Delay Input to Output

CIRCUIT DIAGRAMS

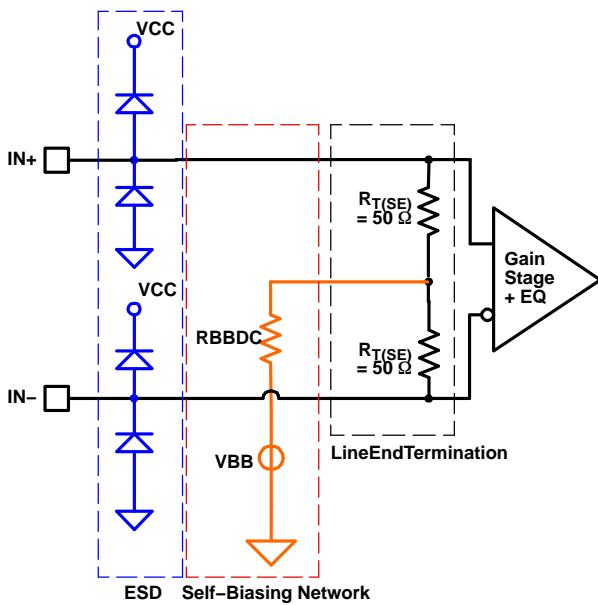

Figure 5. Equivalent Input Circuit Design

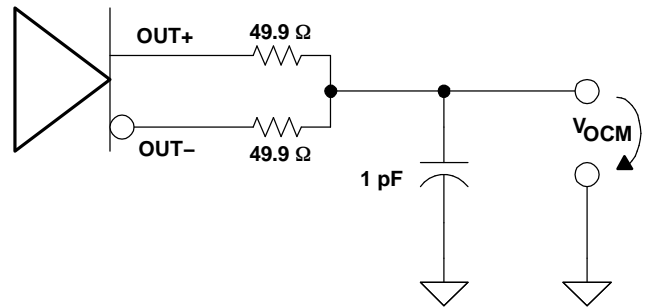
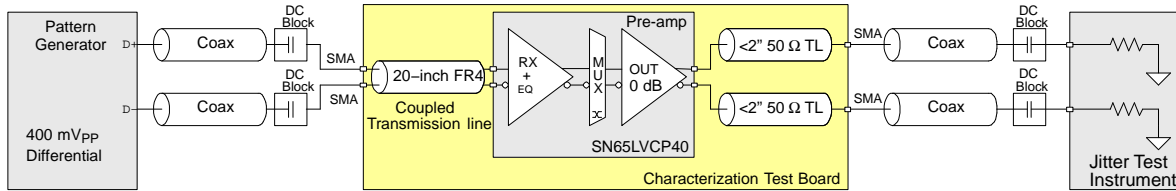

Figure 6. Common-Mode Output Voltage Test Circuit

JITTER TEST CIRCUIT



NOTE: For the Jitter Test, the preemphasis level of the output is set to 0 dB (PREx_x=0)

Figure 7. AC Test Circuit – Jitter and Output Rise Time Test Circuit

The SN65LVCP40 input equalizer provides 5-dB frequency gain to compensate for frequency loss of a shorter backplane transmission line. For characterization purposes, a 24-inch FR-4 coupled transmission line is used in place of the backplane trace. The 24-inch trace provides roughly 5 dB of attenuation between 375 MHz and 1.875 GHz, representing closely the characteristics of a short backplane trace. The loss tangent of the FR4 in the test board is 0.018 with an effective $\epsilon(r)$ of 3.1.

TYPICAL DEVICE BEHAVIOR

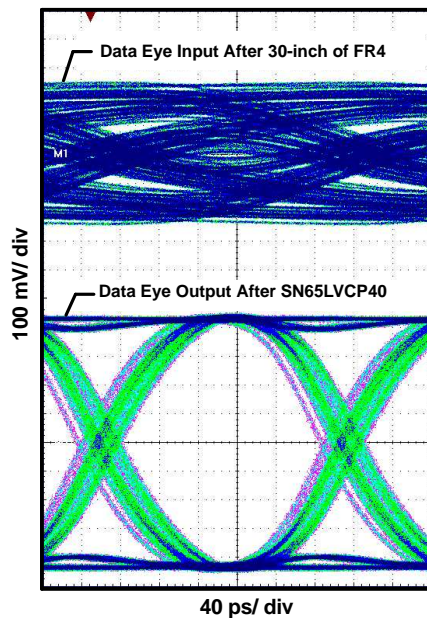

NOTE: 30 Inch Input Trace, dR = 4 Gbps; 2^{7-1} PRBS

Figure 8. Data Input and Output Pattern

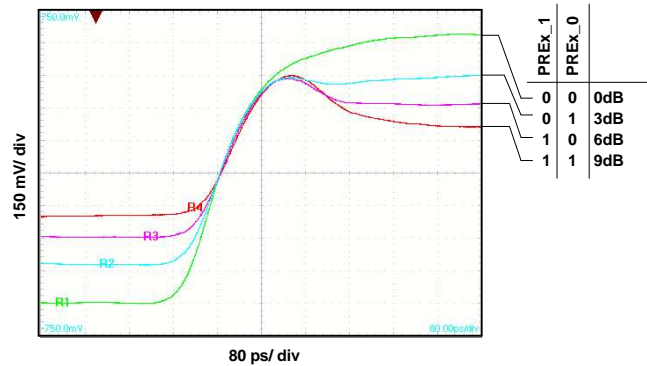

Figure 9. Preemphasis Signal Shape

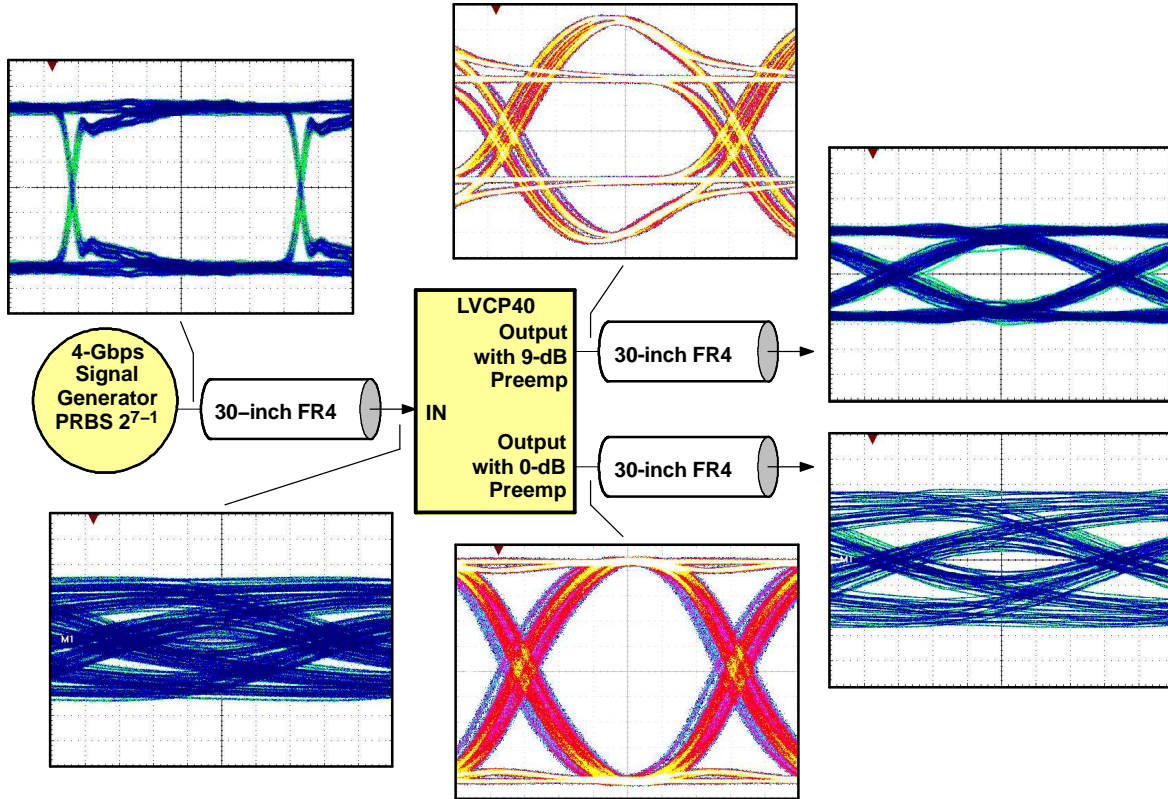

Figure 10. Data Output Pattern

TYPICAL CHARACTERISTICS

DETERMINISTIC OUTPUT JITTER
VS
DATA RATE

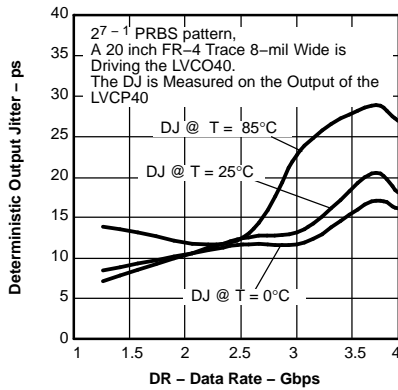

Figure 11.

DETERMINISTIC OUTPUT JITTER
VS
DIFFERENTIAL INPUT AMPLITUDE

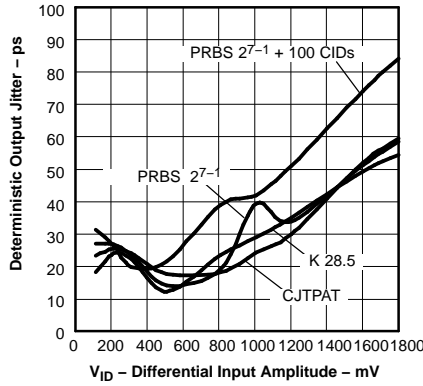

Figure 12.

DETERMINISTIC OUTPUT JITTER
VS
DIFFERENTIAL INPUT AMPLITUDE

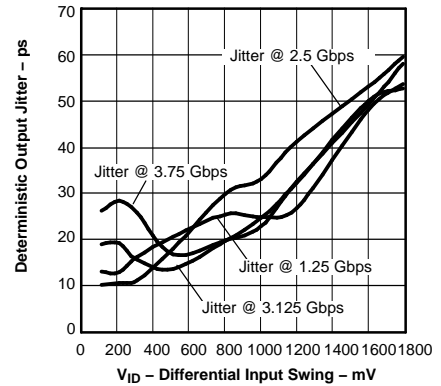

Figure 13.

DETERMINISTIC OUTPUT JITTER
VS
INPUT TRACE LENGTH

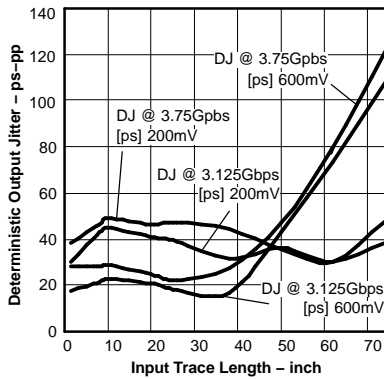

Figure 14.

RANDOM OUTPUT JITTER
VS
DATA RATE

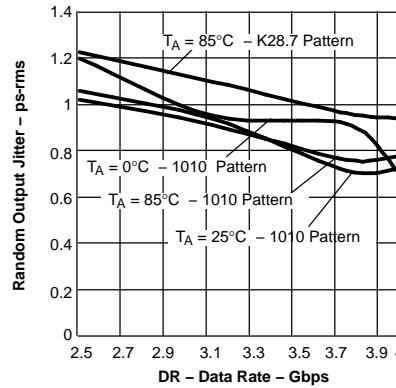

Figure 15.

RANDOM OUTPUT JITTER
VS
DIFFERENTIAL INPUT SWING

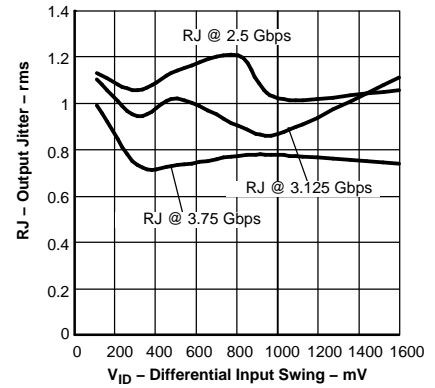

Figure 16.

RANDOM OUTPUT JITTER
VS
INPUT TRACE LENGTH

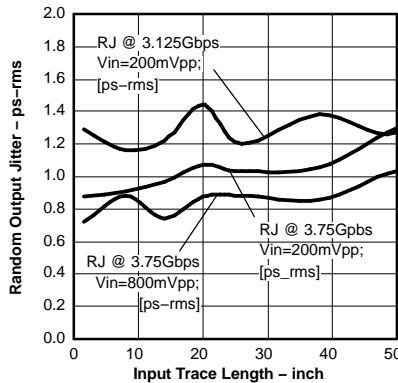

Figure 17.

TOTAL OUTPUT JITTER
VS
POWER SUPPLY NOISE

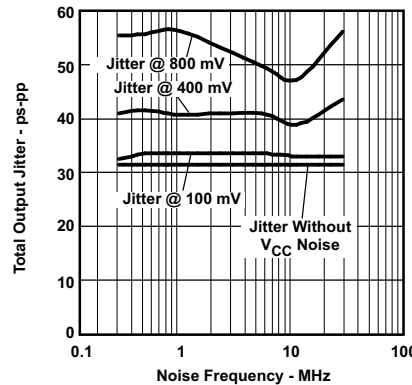

Figure 18.

DJ/RJ OUTPUT JITTER
VS
COMMON-MODE INPUT VOLTAGE

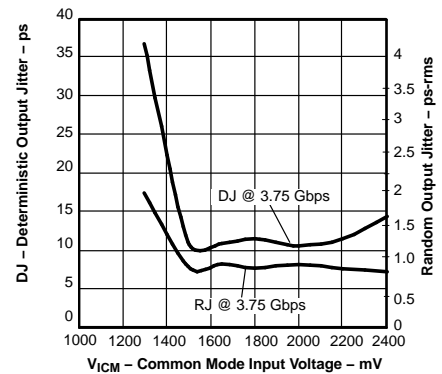

Figure 19.

TYPICAL CHARACTERISTICS (continued)

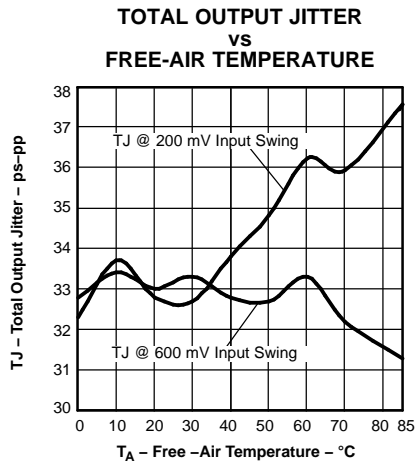

Figure 20.

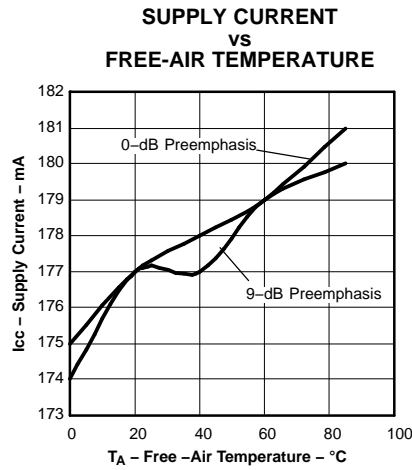

Figure 21.

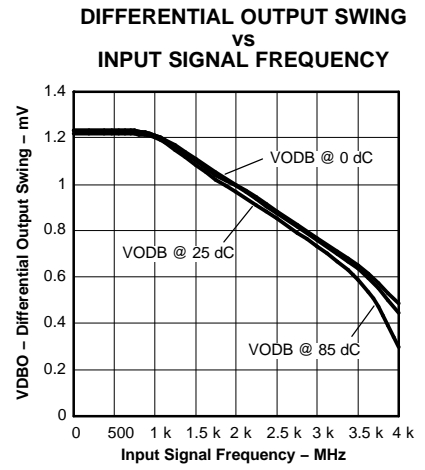

Figure 22.

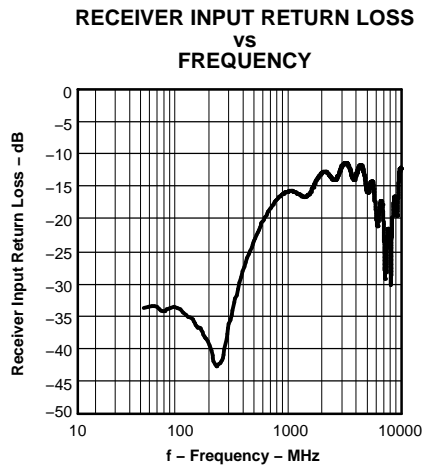

Figure 23.

APPLICATION INFORMATION

BANDWIDTH REQUIREMENTS

Error free transmission of data over a transmission line has specific bandwidth demands. It is helpful to analyze the frequency spectrum of the transmit data first. For an 8B10B coded data stream at 3.75 Gbps of random data, the highest bit transition density occurs with a 1010 pattern (1.875 GHz). The least transition density in 8B10B allows for five consecutive ones or zeros. Hence, the lowest frequency of interest is $1.875 \text{ GHz}/5 = 375 \text{ MHz}$. Real data signals consist of higher frequency components than sine waves due to the fast rise time. The faster the rise time, the more bandwidth becomes required. For 80-ps rise time, the highest important frequency component is at least $0.6/(\pi \times 80 \text{ ps}) = 2.4 \text{ GHz}$. Figure 24 shows the Fourier transformation of the 375-MHz and 1.875-GHz trapezoidal signal.

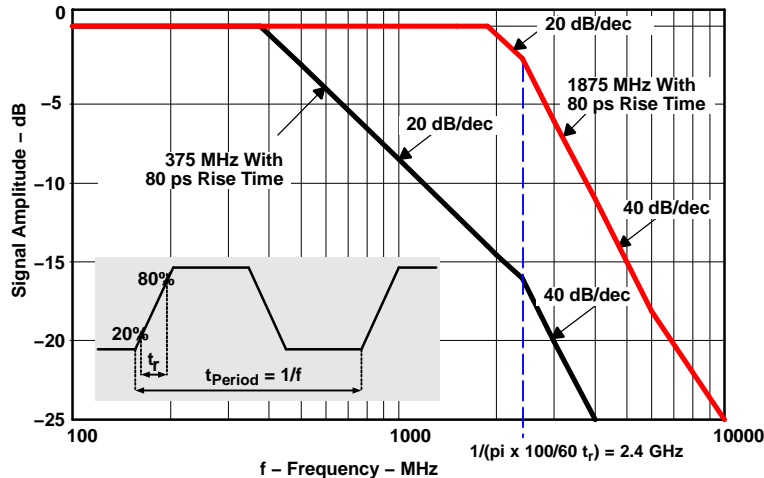

Figure 24. Approximate Frequency Spectrum of the Transmit Output Signal With 80 ps Rise Time

The spectrum analysis of the data signal suggests building a backplane with little frequency attenuation up to 2 GHz. Practically, this is achievable only with expensive, specialized PCB material. To support material like FR4, a compensation technique is necessary to compensate for backplane imperfections.

EXPLANATION OF EQUALIZATION

Backplane designs differ widely in size, layer stack-up, and connector placement. In addition, the performance is impacted by trace architecture (trace width, coupling method) and isolation from adjacent signals. Common to most commercial backplanes is the use of FR4 as board material and its related high-frequency signal attenuation. Within a backplane, the shortest to longest trace lengths differ substantially – often ranging from 8 inches up to 40 inches. Increased loss is associated with longer signal traces. In addition, the backplane connector often contributes a good amount of signal attenuation. As a result, the frequency signal attenuation for a 300-MHz signal might range from 1 dB to 4 dB while the corresponding attenuation for a 2-GHz signal might span 6 dB to 24 dB. This frequency dependent loss causes distortion jitter on the transmitted signal. Each LVCP40 receiver input incorporates an equalizer and compensates for such frequency loss. The SN65LVCP40 equalizer provides 5 dB of frequency gain between 375 MHz and 1.875 GHz, compensating roughly for 20 inches of FR4 material with 8-mil trace width. Distortion jitter improvement is substantial, often providing more than 30-ps jitter reduction. The 5-dB compensation is sufficient for most short backplane traces. For longer trace lengths, it is recommended to enable transmit preemphasis in addition.

SETTING THE PREEMPHASIS LEVEL

The receive equalization compensates for ISI. This reduces jitter and opens the data eye. In order to find the best preemphasis setting for each link, calibration of every link is recommended. Assuming each link consists of a transmitter (with adjustable pre-emphasis such as LVCP40) and the LVCP40 receiver, the following steps are necessary:

1. Set the transmitter and receiver to 0-dB preemphasis; record the data eye on the LVCP40 receiver output.
2. Increase the transmitter preemphasis until the data eye on the LVCP40 receiver output looks the cleanest.

APPLICATION INFORMATION (continued)

RECEIVER FAIL-SAFE RESPONSE

If the input is removed from a powered receiver of the 'LVCP40, there are no internal fail-safe provisions to prevent noise from switching the output. [Figure 25](#) shows one remedy using 1.6 k Ω resistors to pull up on one input to the SN65LVCP40 supply, and pull down the other input to its ground. Assuming the differential noise in the system is less than 25 mV, this maintains a valid output with no input. If the noise is greater than 25 mV, lower fail-safe resistance is required.

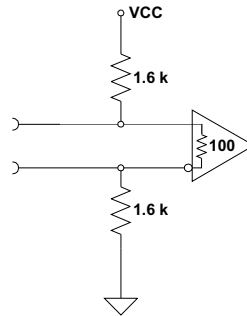

Figure 25. Fail-Safe Bias Resistors

If the driver is another SN65LVCP40, attenuation from the driver to receiver must be less than 250 mV or 6 dB. This value comes from the minimum output of 500 mV into 100 Ω less the minimum recommended input voltage of 100 mV, 25 mV for noise, and 125 mV for the maximum fail-safe bias.

The fail-safe bias also introduces additional *eye-pattern* jitter depending upon the input voltage transition time, but is designed to be less than 10% of the unit interval.

The only other options are to have a hardware interlock that removed power to the receiver, or switched in a fail-safe bias, or rely on error detection to ignore random inputs.

PACKAGING INFORMATION

Orderable Device	Status (1)	Package Type	Package Drawing	Pins	Package Qty	Eco Plan (2)	Lead finish/ Ball material (6)	MSL Peak Temp (3)	Op Temp (°C)	Device Marking (4/5)	Samples
SN65LVCP40RGZ	OBSOLETE	VQFN	RGZ	48		TBD	Call TI	Call TI	-40 to 85	LVCP40	
SN65LVCP40RGZR	OBSOLETE	VQFN	RGZ	48		TBD	Call TI	Call TI	-40 to 85	LVCP40	
SN65LVCP40RGZT	OBSOLETE	VQFN	RGZ	48		TBD	Call TI	Call TI	-40 to 85	LVCP40	

(1) The marketing status values are defined as follows:

ACTIVE: Product device recommended for new designs.

LIFEBUY: TI has announced that the device will be discontinued, and a lifetime-buy period is in effect.

NRND: Not recommended for new designs. Device is in production to support existing customers, but TI does not recommend using this part in a new design.

PREVIEW: Device has been announced but is not in production. Samples may or may not be available.

OBSOLETE: TI has discontinued the production of the device.

(2) **RoHS:** TI defines "RoHS" to mean semiconductor products that are compliant with the current EU RoHS requirements for all 10 RoHS substances, including the requirement that RoHS substance do not exceed 0.1% by weight in homogeneous materials. Where designed to be soldered at high temperatures, "RoHS" products are suitable for use in specified lead-free processes. TI may reference these types of products as "Pb-Free".

RoHS Exempt: TI defines "RoHS Exempt" to mean products that contain lead but are compliant with EU RoHS pursuant to a specific EU RoHS exemption.

Green: TI defines "Green" to mean the content of Chlorine (Cl) and Bromine (Br) based flame retardants meet JS709B low halogen requirements of <=1000ppm threshold. Antimony trioxide based flame retardants must also meet the <=1000ppm threshold requirement.

(3) MSL, Peak Temp. - The Moisture Sensitivity Level rating according to the JEDEC industry standard classifications, and peak solder temperature.

(4) There may be additional marking, which relates to the logo, the lot trace code information, or the environmental category on the device.

(5) Multiple Device Markings will be inside parentheses. Only one Device Marking contained in parentheses and separated by a "~" will appear on a device. If a line is indented then it is a continuation of the previous line and the two combined represent the entire Device Marking for that device.

(6) Lead finish/Ball material - Orderable Devices may have multiple material finish options. Finish options are separated by a vertical ruled line. Lead finish/Ball material values may wrap to two lines if the finish value exceeds the maximum column width.

Important Information and Disclaimer:The information provided on this page represents TI's knowledge and belief as of the date that it is provided. TI bases its knowledge and belief on information provided by third parties, and makes no representation or warranty as to the accuracy of such information. Efforts are underway to better integrate information from third parties. TI has taken and continues to take reasonable steps to provide representative and accurate information but may not have conducted destructive testing or chemical analysis on incoming materials and chemicals. TI and TI suppliers consider certain information to be proprietary, and thus CAS numbers and other limited information may not be available for release.

In no event shall TI's liability arising out of such information exceed the total purchase price of the TI part(s) at issue in this document sold by TI to Customer on an annual basis.

GENERIC PACKAGE VIEW

RGZ 48

VQFN - 1 mm max height

7 x 7, 0.5 mm pitch

PLASTIC QUADFLAT PACK- NO LEAD

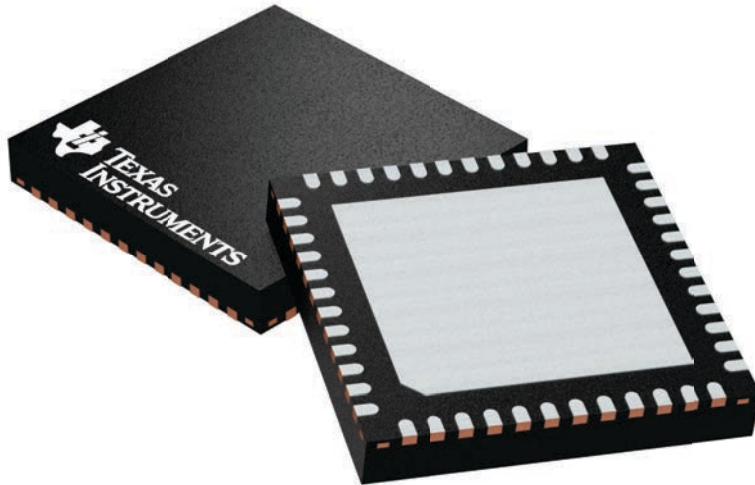

Images above are just a representation of the package family, actual package may vary.
Refer to the product data sheet for package details.

4224671/A

IMPORTANT NOTICE AND DISCLAIMER

TI PROVIDES TECHNICAL AND RELIABILITY DATA (INCLUDING DATA SHEETS), DESIGN RESOURCES (INCLUDING REFERENCE DESIGNS), APPLICATION OR OTHER DESIGN ADVICE, WEB TOOLS, SAFETY INFORMATION, AND OTHER RESOURCES "AS IS" AND WITH ALL FAULTS, AND DISCLAIMS ALL WARRANTIES, EXPRESS AND IMPLIED, INCLUDING WITHOUT LIMITATION ANY IMPLIED WARRANTIES OF MERCHANTABILITY, FITNESS FOR A PARTICULAR PURPOSE OR NON-INFRINGEMENT OF THIRD PARTY INTELLECTUAL PROPERTY RIGHTS.

These resources are intended for skilled developers designing with TI products. You are solely responsible for (1) selecting the appropriate TI products for your application, (2) designing, validating and testing your application, and (3) ensuring your application meets applicable standards, and any other safety, security, regulatory or other requirements.

These resources are subject to change without notice. TI grants you permission to use these resources only for development of an application that uses the TI products described in the resource. Other reproduction and display of these resources is prohibited. No license is granted to any other TI intellectual property right or to any third party intellectual property right. TI disclaims responsibility for, and you will fully indemnify TI and its representatives against, any claims, damages, costs, losses, and liabilities arising out of your use of these resources.

TI's products are provided subject to [TI's Terms of Sale](#) or other applicable terms available either on [ti.com](https://www.ti.com) or provided in conjunction with such TI products. TI's provision of these resources does not expand or otherwise alter TI's applicable warranties or warranty disclaimers for TI products.

TI objects to and rejects any additional or different terms you may have proposed.

Mailing Address: Texas Instruments, Post Office Box 655303, Dallas, Texas 75265
Copyright © 2024, Texas Instruments Incorporated