

SN74LV125A Quadruple Bus Buffer Gates With 3-State Outputs

1 Features

- 2-V to 5.5-V V_{CC} Operation
- Max t_{pd} of 6 ns at 5 V
- Typical V_{OLP} (Output Ground Bounce) < 0.8 V at $V_{CC} = 3.3$ V, $T_A = 25^\circ\text{C}$
- Typical V_{OHV} (Output V_{OH} Undershoot) > 2.3 V at $V_{CC} = 3.3$ V, $T_A = 25^\circ\text{C}$
- Support Mixed-Mode Voltage Operation on All Ports
- I_{off} Supports Partial-Power-Down Mode Operation
- Latch-Up Performance Exceeds 250 mA Per JESD 17
- ESD Protection Exceeds JESD 22
 - 4000-V Human-Body Model
 - 200-V Machine Model
 - 2000-V Charged-Device Model

2 Applications

- Flow Meters
- Solid State Drives (SSDs): Enterprise
- Power Over Ethernet (PoE)
- Programmable Logic Controllers
- Motor Drives and Controls
- Electronic Points of Sale

3 Description

The SN74LV125A quadruple bus buffer gate is designed for 2-V to 5.5-V V_{CC} operation.

Device Information

PART NUMBER ⁽¹⁾	PACKAGE	BODY SIZE (NOM)
SN74LV125A	DGV (TVSOP, 14)	3.60 mm x 4.40 mm
	D (SOIC, 14)	8.65 mm x 3.90 mm
	NS (SO, 14)	10.20 mm x 5.30 mm
	DB (SSOP, 14)	6.20 mm x 5.30 mm
	PW (TSSOP, 14)	5.00 mm x 4.40 mm

(1) For all available packages, see the orderable addendum at the end of the data sheet.

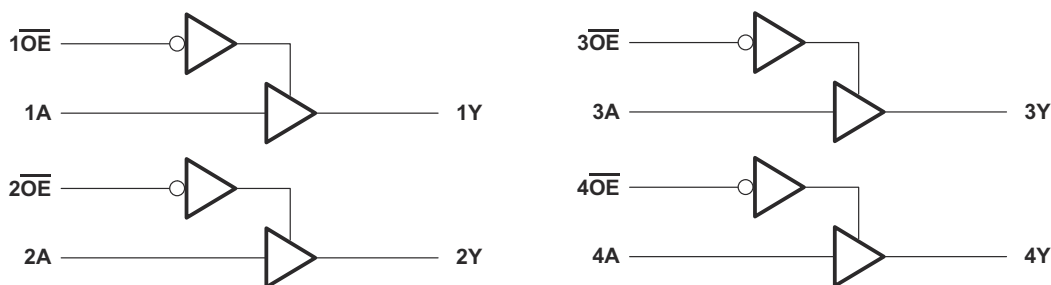

Simplified Schematic



Table of Contents

1 Features	1	8 Detailed Description	9
2 Applications	1	8.1 Overview.....	9
3 Description	1	8.2 Functional Block Diagram.....	9
4 Revision History	2	8.3 Feature Description.....	9
5 Pin Configuration and Functions	3	8.4 Device Functional Modes.....	9
Pin Functions.....	3	9 Application and Implementation	10
6 Specifications	4	9.1 Application Information.....	10
6.1 Absolute Maximum Ratings.....	4	9.2 Typical Application.....	10
6.2 ESD Ratings.....	4	10 Power Supply Recommendations	11
6.3 Recommended Operating Conditions.....	5	11 Layout	12
6.4 Thermal Information.....	5	11.1 Layout Guidelines.....	12
6.5 Electrical Characteristics.....	6	11.2 Layout Example.....	12
6.6 Switching Characteristics, $V_{CC} = 2.5\text{ V} \pm 0.2\text{ V}$	6	12 Device and Documentation Support	12
6.7 Switching Characteristics, $V_{CC} = 3.3\text{ V} \pm 0.3\text{ V}$	6	12.1 Related Links.....	12
6.8 Switching Characteristics, $V_{CC} = 5\text{ V} \pm 0.5\text{ V}$	7	12.2 Trademarks.....	12
6.9 Noise Characteristics.....	7	12.3 Electrostatic Discharge Caution.....	12
6.10 Operating Characteristics.....	7	12.4 Glossary.....	12
6.11 Typical Characteristics.....	7	13 Mechanical, Packaging, and Orderable Information	12
7 Parameter Measurement Information	8		

4 Revision History

Changes from Revision N (January 2015) to Revision O (May 2022)	Page
• Updated the numbering, formatting, tables, figures, and cross-references throughout the document to reflect modern data sheet standards.....	4
Changes from Revision M (December 2014) to Revision N (January 2015)	Page
• Added T_j spec to <i>Absolute Maximum Ratings</i> table.....	4
• Added text to <i>Overview</i> section	9
Changes from Revision L (April 2005) to Revision M (December 2014)	Page
• Added <i>Applications</i> , <i>Device Information</i> table, <i>Pin Functions</i> table, <i>ESD Ratings</i> table, <i>Thermal Information</i> table, <i>Typical Characteristics</i> , <i>Feature Description</i> section, <i>Device Functional Modes</i> , <i>Application and Implementation</i> section, <i>Power Supply Recommendations</i> section, <i>Layout</i> section, <i>Device and Documentation Support</i> section, and <i>Mechanical, Packaging, and Orderable Information</i> section.....	1
• Deleted <i>Ordering Information</i> table.....	1
• Changed MAX operating temperature to 125°C in <i>Recommended Operating Conditions</i> table.	5

5 Pin Configuration and Functions

SN74LV125A . . . D, DB, DGV, N, NS,
OR PW PACKAGE
(TOP VIEW)

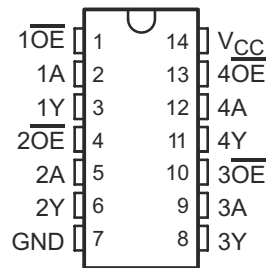

SN74LV125A . . . RGY PACKAGE
(TOP VIEW)

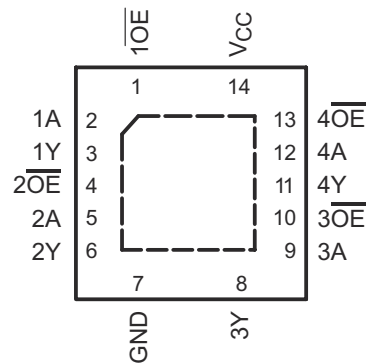

Pin Functions

PIN		TYPE ⁽¹⁾	DESCRIPTION
NO.	NAME		
1	$\overline{1OE}$	I	Output Enable 1, Active Low
2	1A	I	1A Input
3	1Y	O	1Y Output
4	$\overline{2OE}$	I	Output Enable 2, Active Low
5	2A	I	2A Input
6	2Y	O	2Y Output
7	GND	—	Ground Pin
8	3Y	O	3Y Output
9	3A	I	3A Input
10	$\overline{3OE}$	I	Output Enable 3, Active Low
11	4Y	O	4Y Output
12	4A	I	4A Input
13	$\overline{4OE}$	I	Output Enable 4, Active Low
14	V _{CC}	—	Power Pin

(1) Signal Types: I = Input, O = Output, I/O = Input or Output.

6 Specifications

6.1 Absolute Maximum Ratings

over operating free-air temperature range (unless otherwise noted)

		MIN ⁽¹⁾	MAX	UNIT	
V _{CC}	Supply voltage	-0.5	7	V	
V _I	Input voltage range ⁽²⁾	-0.5	7	V	
V _O	Voltage range applied to any output in the high-impedance or power-off state ⁽²⁾	-0.5	7	V	
V _O	Output voltage range ^{(2) (3)}	-0.5	V _{CC} + 0.5	V	
I _{IK}	Input clamp current	V _I < 0		-20	mA
I _{OK}	Output clamp current	V _O < 0		-50	mA
I _O	Continuous output current	V _O = 0 to V _{CC}		±35	mA
	Continuous current through V _{CC} or GND			±70	mA
T _J	Junction temperature			150	°C
T _{stg}	Storage temperature	-65	150	°C	

- (1) Stresses beyond those listed under *Absolute Maximum Ratings* may cause permanent damage to the device. These are stress ratings only, and functional operation of the device at these or any other conditions beyond those indicated under [Section 6.3](#) is not implied. Exposure to absolute-maximum-rated conditions for extended periods may affect device reliability.
- (2) The input and output negative-voltage ratings may be exceeded if the input and output current ratings are observed.
- (3) This value is limited to 5.5-V maximum.

6.2 ESD Ratings

		MAX	UNIT
V _(ESD)	Electrostatic discharge	Human body model (HBM), per ANSI/ESDA/JEDEC JS-001, all pins ⁽¹⁾	±4000
		Charged device model (CDM), per JEDEC specification JESD22-C101, all pins ⁽²⁾	±2000
		Machine Model (MM)	±200

- (1) JEDEC document JEP155 states that 500-V HBM allows safe manufacturing with a standard ESD control process.
- (2) JEDEC document JEP157 states that 250-V CDM allows safe manufacturing with a standard ESD control process.

6.3 Recommended Operating Conditions

over operating free-air temperature range (unless otherwise noted)⁽¹⁾

		SN74LV125A		UNIT	
		MIN	MAX		
V _{CC}	Supply voltage	2	5.5	V	
V _{IH}	High-level input voltage	V _{CC} = 2 V	1.5	V	
		V _{CC} = 2.3 V to 2.7 V	V _{CC} × 0.7		
		V _{CC} = 3 V to 3.6 V	V _{CC} × 0.7		
		V _{CC} = 4.5 V to 5.5 V	V _{CC} × 0.7		
V _{IL}	Low-level input voltage	V _{CC} = 2 V	0.5	V	
		V _{CC} = 2.3 V to 2.7 V	V _{CC} × 0.3		
		V _{CC} = 3 V to 3.6 V	V _{CC} × 0.3		
		V _{CC} = 4.5 V to 5.5 V	V _{CC} × 0.3		
V _I	Input voltage	0	5.5	V	
V _O	Output voltage	High or low state	0	V _{CC}	V
		3-state	0	5.5	
I _{OH}	High-level output current	V _{CC} = 2 V		-50	μA
		V _{CC} = 2.3 V to 2.7 V		-2	
		V _{CC} = 3 V to 3.6 V		-8	
		V _{CC} = 4.5 V to 5.5 V		-16	
I _{OL}	Low-level output current	V _{CC} = 2 V		50	μA
		V _{CC} = 2.3 V to 2.7 V		2	
		V _{CC} = 3 V to 3.6 V		8	
		V _{CC} = 4.5 V to 5.5 V		16	
Δt/Δv	Input transition rise or fall rate	V _{CC} = 2.3 V to 2.7 V		200	ns/V
		V _{CC} = 3 V to 3.6 V		100	
		V _{CC} = 4.5 V to 5.5 V		20	
T _A	Operating free-air temperature	-40	125	°C	

(1) All unused inputs of the device must be held at V_{CC} or GND to ensure proper device operation. Refer to the TI application report, *Implications of Slow or Floating CMOS Inputs* (SCBA004).

6.4 Thermal Information

THERMAL METRIC ⁽¹⁾	SN74LV125A								UNIT
	D	DB	DGV	N	NS	PW	RGY	14 PINS	
R _{θJA}	Junction-to-ambient thermal resistance	92.7	105.0	127.6	89.2	89.6	119.8	55.0	°C/W
R _{θJC(top)}	Junction-to-case (top) thermal resistance	54.1	57.5	50.7	47.0	47.2	48.6	67.4	
R _{θJB}	Junction-to-board thermal resistance	47.0	52.3	60.5	47.9	48.4	61.5	31.0	
Ψ _{JT}	Junction-to-top characterization parameter	18.9	19.1	6.1	14.1	14.0	5.7	2.6	
Ψ _{JB}	Junction-to-board characterization parameter	46.7	51.8	59.8	47.5	48.1	61.0	31.1	
R _{θJC(bot)}	Junction-to-case (bottom) thermal resistance	N/A	N/A	N/A	N/A	N/A	N/A	11.6	

(1) For more information about traditional and new thermal metrics, see the *IC Package Thermal Metrics* application report (SPRA953).

6.5 Electrical Characteristics

over recommended operating free-air temperature range (unless otherwise noted)

PARAMETER	TEST CONDITIONS	V _{CC}	T _A = 25°C			–40°C to 85°C		–40°C to 125°C		UNIT
			MIN	TYP	MAX	MIN	MAX	MIN	MAX	
V _{OH}	I _{OH} = –50 μA	2 V to 5.5 V	V _{CC} – 0.1			V _{CC} – 0.1		V _{CC} – 0.1		V
	I _{OH} = –2 mA	2.3 V	2			2		2		
	I _{OH} = –8 mA	3 V	2.48			2.48		2.48		
	I _{OH} = –16 mA	4.5 V	3.8			3.8		3.8		
V _{OL}	I _{OL} = 50 μA	2 V to 5.5 V	0.1			0.1		0.1		V
	I _{OL} = 2 mA	2.3 V	0.4			0.4		0.4		
	I _{OL} = 8 mA	3 V	0.44			0.44		0.44		
	I _{OL} = 16 mA	4.5 V	0.55			0.55		0.55		
I _I	V _I = 5.5 V or GND	0 to 5.5 V	±1			±1		±1		μA
I _{OZ}	V _O = V _{CC} or GND	5.5 V	±5			±5		±5		μA
I _{CC}	V _I = V _{CC} or GND, I _O = 0	5.5 V	20			20		20		μA
I _{off}	V _I or V _O = 0 to 5.5 V	0	5			5		5		μA
C _i	V _I = V _{CC} or GND	3.3 V	1.6							pF
		5 V	1.6							

6.6 Switching Characteristics, V_{CC} = 2.5 V ± 0.2 V

over recommended operating free-air temperature range (unless otherwise noted) (see Figure 7-1)

PARAMETER	FROM (INPUT)	TO (OUTPUT)	LOAD CAPACITANCE	T _A = 25°C			–40°C to 85°C		–40°C to 125°C		UNIT
				MIN	TYP	MAX	MIN	MAX	MIN	MAX	
t _{pd}	A	Y	C _L = 15 pF		6.8 ⁽¹⁾	13 ⁽¹⁾	1	15.5	1	17	ns
t _{en}	$\overline{\text{OE}}$	Y		7 ⁽¹⁾	13 ⁽¹⁾	1	15.5	1	17		
t _{dis}	$\overline{\text{OE}}$	Y		5.1 ⁽¹⁾	14.7 ⁽¹⁾	1	17	1	18		
t _{pd}	A	Y	C _L = 50 pF		8.7	16.5	1	18.5	1	20	ns
t _{en}	$\overline{\text{OE}}$	Y		8.8	16.5	1	18.5	1	20		
t _{dis}	$\overline{\text{OE}}$	Y		7.3	18.2	1	20.5	1	21.5		
t _{sk(o)}						2		2		2	

(1) On products compliant to MIL-PRF-38535, this parameter is not production tested.

6.7 Switching Characteristics, V_{CC} = 3.3 V ± 0.3 V

over recommended operating free-air temperature range (unless otherwise noted) (see Figure 7-1)

PARAMETER	FROM (INPUT)	TO (OUTPUT)	LOAD CAPACITANCE	T _A = 25°C			–40°C to 85°C		–40°C to 125°C		UNIT
				MIN	TYP	MAX	MIN	MAX	MIN	MAX	
t _{pd}	A	Y	C _L = 15 pF		4.8 ⁽¹⁾	8 ⁽¹⁾	1	9.5	1	11	ns
t _{en}	$\overline{\text{OE}}$	Y		4.8 ⁽¹⁾	8 ⁽¹⁾	1	9.5	1	10.5		
t _{dis}	$\overline{\text{OE}}$	Y		4.1 ⁽¹⁾	9.7 ⁽¹⁾	1	11.5	1	12.5		
t _{pd}	A	Y	C _L = 50 pF		6.1	11.5	1	13	1	14.5	ns
t _{en}	$\overline{\text{OE}}$	Y		6.2	11.5	1	13	1	14		
t _{dis}	$\overline{\text{OE}}$	Y		5.5	13.2	1	15	1	16		
t _{sk(o)}						1.5		1.5		1.5	

(1) On products compliant to MIL-PRF-38535, this parameter is not production tested.

6.8 Switching Characteristics, $V_{CC} = 5\text{ V} \pm 0.5\text{ V}$

over recommended operating free-air temperature range (unless otherwise noted) (see Figure 7-1)

PARAMETER	FROM (INPUT)	TO (OUTPUT)	LOAD CAPACITANCE	$T_A = 25^\circ\text{C}$			$-40^\circ\text{C to } 85^\circ\text{C}$		$-40^\circ\text{C to } 125^\circ\text{C}$		UNIT
				MIN	TYP	MAX	MIN	MAX	MIN	MAX	
t_{pd}	A	Y	$C_L = 15\text{ pF}$	3.4 ⁽¹⁾	5.5 ⁽¹⁾		1	6.5	1	7.5	ns
t_{en}	\overline{OE}	Y		3.4 ⁽¹⁾	5.1 ⁽¹⁾		1	6	1	7	
t_{dis}	\overline{OE}	Y		3.2 ⁽¹⁾	6.8 ⁽¹⁾		1	8	1	9	
t_{pd}	A	Y	$C_L = 50\text{ pF}$	4.3	7.5		1	8.5	1	9.5	ns
t_{en}	\overline{OE}	Y		4.4	7.1		1	8	1	9	
t_{dis}	\overline{OE}	Y		4	8.8		1	10	1	11	
$t_{sk(o)}$						1		1		1	

(1) On products compliant to MIL-PRF-38535, this parameter is not production tested.

6.9 Noise Characteristics

$V_{CC} = 3.3\text{ V}$, $C_L = 50\text{ pF}$, $T_A = 25^\circ\text{C}$

PARAMETER ⁽¹⁾	SN74LV125A			UNIT
	MIN	TYP	MAX	
$V_{OL(P)}$ Quiet output, maximum dynamic V_{OL}		0.4	0.8	V
$V_{OL(V)}$ Quiet output, minimum dynamic V_{OL}		-0.3	-0.8	V
$V_{OH(V)}$ Quiet output, minimum dynamic V_{OH}		3		V
$V_{IH(D)}$ High-level dynamic input voltage	2.31			V
$V_{IL(D)}$ Low-level dynamic input voltage			0.99	V

(1) Characteristics are for surface-mount packages only.

6.10 Operating Characteristics

$T_A = 25^\circ\text{C}$

PARAMETER		TEST CONDITIONS	V_{CC}	TYP	UNIT
C_{pd}	Power dissipation capacitance		Outputs enabled	3.3 V	
			5 V	17.6	

6.11 Typical Characteristics

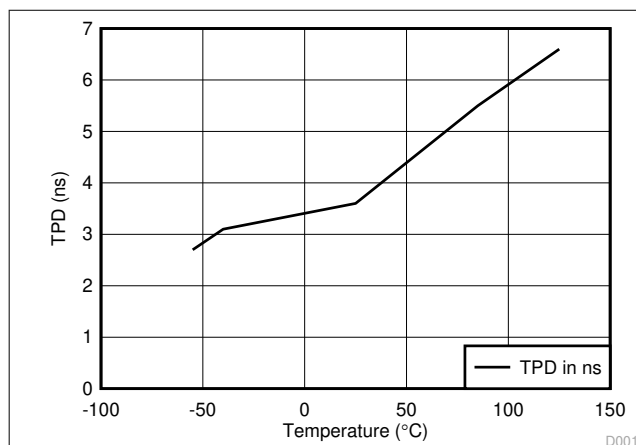

Figure 6-1. TPD vs Temperature

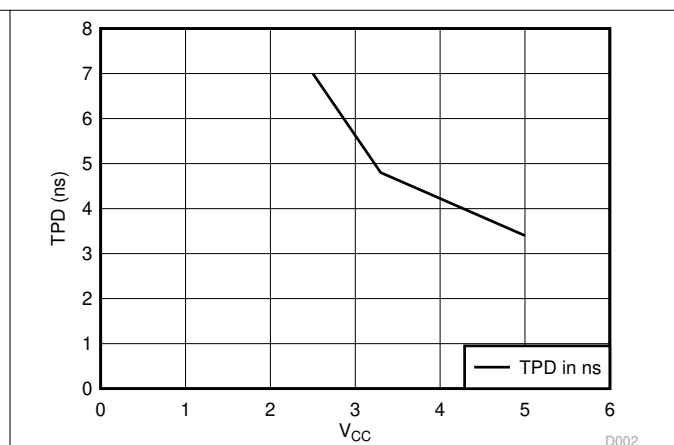
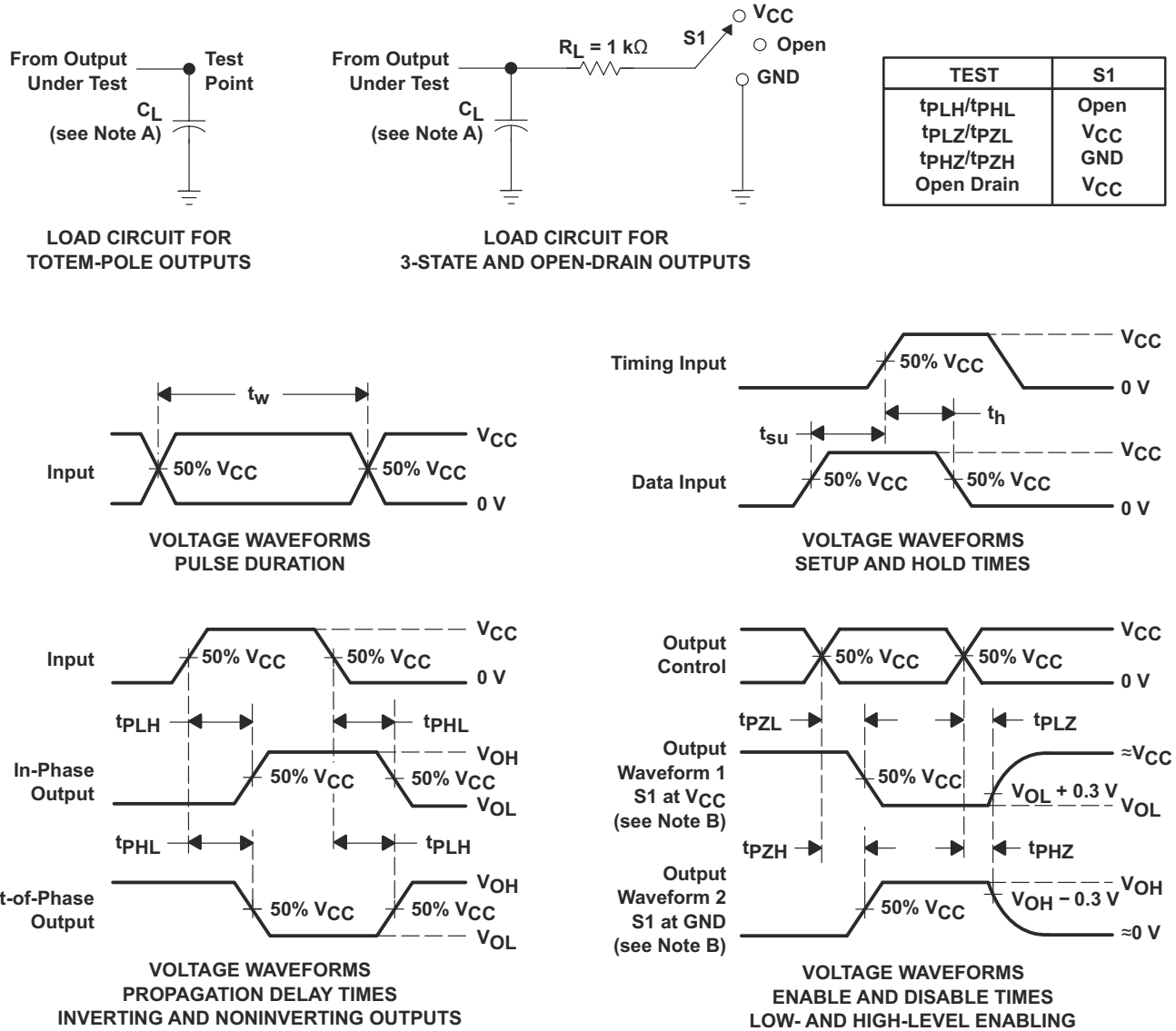

Figure 6-2. TPD vs V_{CC} at 25°C

7 Parameter Measurement Information

7.1



- NOTES: A. C_L includes probe and jig capacitance.
 B. Waveform 1 is for an output with internal conditions such that the output is low, except when disabled by the output control. Waveform 2 is for an output with internal conditions such that the output is high, except when disabled by the output control.
 C. All input pulses are supplied by generators having the following characteristics: $PRR \leq 1\text{ MHz}$, $Z_O = 50\ \Omega$, $t_r \leq 3\text{ ns}$, $t_f \leq 3\text{ ns}$.
 D. The outputs are measured one at a time, with one input transition per measurement.
 E. t_{PLZ} and t_{PHZ} are the same as t_{dis} .
 F. t_{PZL} and t_{PZH} are the same as t_{en} .
 G. t_{PHL} and t_{PLH} are the same as t_{pd} .
 H. All parameters and waveforms are not applicable to all devices.

Figure 7-1. Load Circuit And Voltage Waveforms

8 Detailed Description

8.1 Overview

The SN74LV125A quadruple bus buffer gate is designed for 2-V to 5.5-V V_{CC} operation.

These devices feature independent line drivers with 3-state outputs. Each output is disabled when the associated output-enable (\overline{OE}) input is high.

To ensure the high-impedance state during power up or power down, tie \overline{OE} to V_{CC} through a pullup resistor; the minimum value of the resistor is determined by the current-sinking capability of the driver.

8.2 Functional Block Diagram

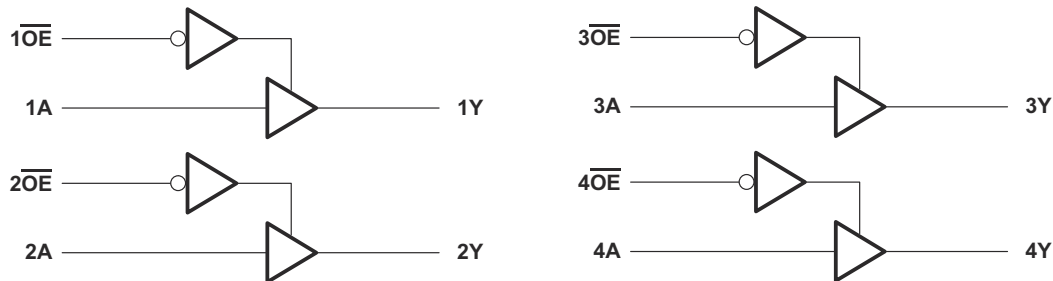

Figure 8-1. Logic Diagram (Positive Logic)

8.3 Feature Description

- Wide operating voltage range
 - Operates from 2 V to 5.5 V
- Allows down-voltage translation
 - Inputs accept voltages to 5.5 V
- I_{off} Feature
 - Supports Live Insertion, Partial Power-Down Mode, and Back-Drive Protection

8.4 Device Functional Modes

Table 8-1. Function Table
(Each Buffer)

INPUTS ⁽¹⁾		OUTPUT ⁽²⁾
\overline{OE}	A	Y
L	H	H
L	L	L
H	X	Z

- (1) H = High Voltage Level, L = Low Voltage Level, X = Don't Care
- (2) H = Driving High, L = Driving Low, Z = High Impedance State

9 Application and Implementation

Note

Information in the following applications sections is not part of the TI component specification, and TI does not warrant its accuracy or completeness. TI's customers are responsible for determining suitability of components for their purposes. Customers should validate and test their design implementation to confirm system functionality.

9.1 Application Information

The SN74LV125A is a low-drive CMOS device that can be used for a multitude of bus interface type applications where output ringing is a concern. The low drive and slow edge rates minimize overshoot and undershoot on the outputs. The inputs are 5.5-V tolerant at any valid V_{CC} , making it ideal for translating down to V_{CC} .

9.2 Typical Application

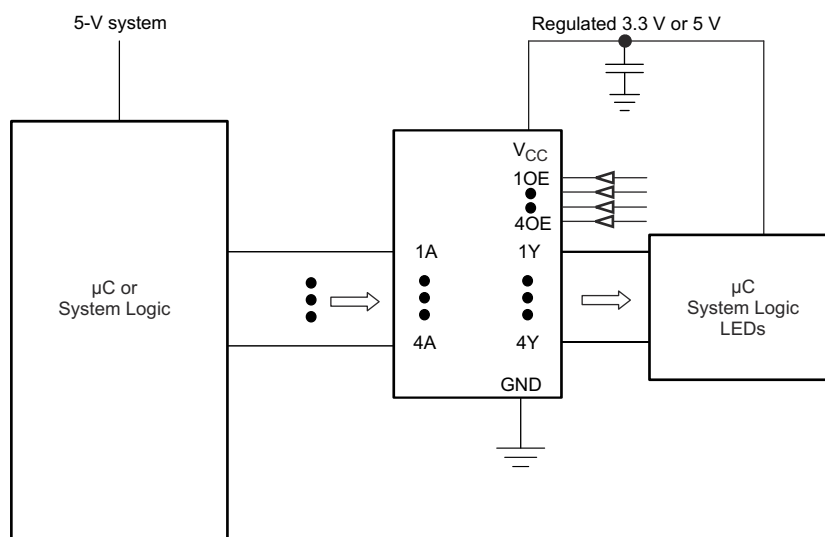

Figure 9-1. Typical Application Schematic

9.2.1 Design Requirements

This device uses CMOS technology and has balanced output drive. Care should be taken to avoid bus contention because it can drive currents that would exceed maximum limits. The high drive will also create fast edges into light loads, so routing and load conditions should be considered to prevent ringing.

9.2.2 Detailed Design Procedure

- Recommended Input Conditions
 - For rise time and fall time specifications, see $\Delta t/\Delta V$ in the [Section 6.3](#) table.
 - For specified High and low levels, see V_{IH} and V_{IL} in the [Section 6.3](#) table.
- Recommend Output Conditions
 - Load currents should not exceed 35 mA per output and 70 mA total for the part.
 - Outputs should not be pulled above V_{CC} .

9.2.3 Application Curves

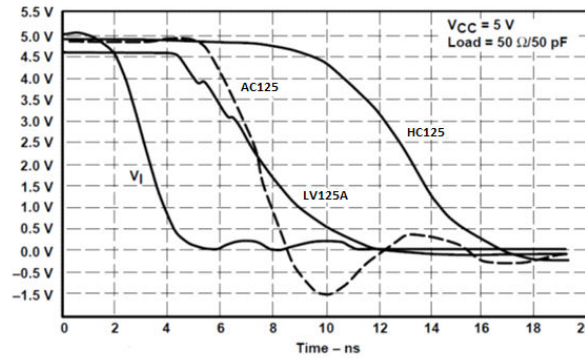

Figure 9-2. Switching Characteristics Comparison

10 Power Supply Recommendations

The power supply can be any voltage between the MIN and MAX supply voltage rating located in the [Section 6.3](#) table.

Each V_{CC} pin should have a good bypass capacitor to prevent power disturbance. For devices with a single supply, 0.1 μF is recommended. If there are multiple V_{CC} pins, 0.01 μF or 0.022 μF is recommended for each power pin. It is acceptable to parallel multiple bypass caps to reject different frequencies of noise. A 0.1 μF and 1 μF are commonly used in parallel. The bypass capacitor should be installed as close to the power pin as possible for best results.

11 Layout

11.1 Layout Guidelines

When using multiple bit logic devices, inputs should not float. In many cases, functions or parts of functions of digital logic devices are unused. Some examples are when only two inputs of a triple-input AND gate are used, or when only 3 of the 4-buffer gates are used. Such input pins should not be left unconnected because the undefined voltages at the outside connections result in undefined operational states.

Specified in [Figure 11-1](#) are rules that must be observed under all circumstances. All unused inputs of digital logic devices must be connected to a high or low bias to prevent them from floating. The logic level that should be applied to any particular unused input depends on the function of the device. Generally they will be tied to GND or V_{CC} , whichever makes more sense or is more convenient. It is acceptable to float outputs unless the part is a transceiver. If the transceiver has an output enable pin, it will disable the outputs section of the part when asserted. This will not disable the input section of the I/Os so they also cannot float when disabled.

11.2 Layout Example

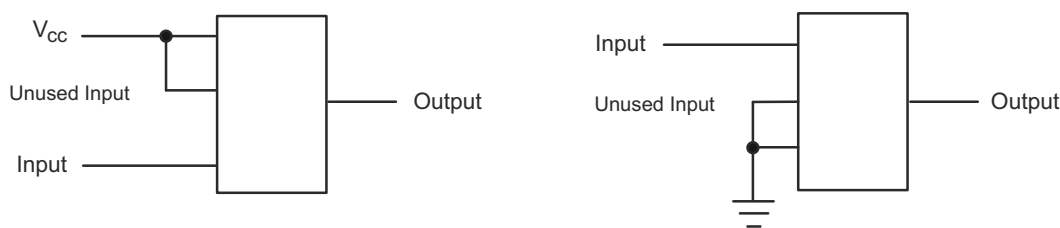

Figure 11-1. Layout Diagram

12 Device and Documentation Support

12.1 Related Links

The table below lists quick access links. Categories include technical documents, support and community resources, tools and software, and quick access to sample or buy.

Table 12-1. Related Links

PARTS	PRODUCT FOLDER	SAMPLE & BUY	TECHNICAL DOCUMENTS	TOOLS & SOFTWARE	SUPPORT & COMMUNITY
SN74LV125A	Click here	Click here	Click here	Click here	Click here

12.2 Trademarks

All trademarks are the property of their respective owners.

12.3 Electrostatic Discharge Caution



This integrated circuit can be damaged by ESD. Texas Instruments recommends that all integrated circuits be handled with appropriate precautions. Failure to observe proper handling and installation procedures can cause damage.

ESD damage can range from subtle performance degradation to complete device failure. Precision integrated circuits may be more susceptible to damage because very small parametric changes could cause the device not to meet its published specifications.

12.4 Glossary

TI Glossary

This glossary lists and explains terms, acronyms, and definitions.

13 Mechanical, Packaging, and Orderable Information

The following pages include mechanical, packaging, and orderable information. This information is the most current data available for the designated devices. This data is subject to change without notice and revision of this document. For browser-based versions of this data sheet, refer to the left-hand navigation.

PACKAGING INFORMATION

Orderable Device	Status (1)	Package Type	Package Drawing	Pins	Package Qty	Eco Plan (2)	Lead finish/ Ball material (6)	MSL Peak Temp (3)	Op Temp (°C)	Device Marking (4/5)	Samples
SN74LV125AD	OBSOLETE	SOIC	D	14		TBD	Call TI	Call TI	-40 to 125	LV125A	
SN74LV125ADBR	ACTIVE	SSOP	DB	14	2000	RoHS & Green	NIPDAU	Level-1-260C-UNLIM	-40 to 125	LV125A	Samples
SN74LV125ADGVR	ACTIVE	TVSOP	DGV	14	2000	RoHS & Green	NIPDAU	Level-1-260C-UNLIM	-40 to 125	LV125A	Samples
SN74LV125ADR	ACTIVE	SOIC	D	14	2500	RoHS & Green	NIPDAU SN	Level-1-260C-UNLIM	-40 to 125	LV125A	Samples
SN74LV125AN	ACTIVE	PDIP	N	14	25	RoHS & Non-Green	NIPDAU	N / A for Pkg Type	-40 to 125	SN74LV125AN	Samples
SN74LV125ANSR	ACTIVE	SO	NS	14	2000	RoHS & Green	NIPDAU	Level-1-260C-UNLIM	-40 to 125	74LV125A	Samples
SN74LV125APW	OBSOLETE	TSSOP	PW	14		TBD	Call TI	Call TI	-40 to 125	LV125A	
SN74LV125APWR	ACTIVE	TSSOP	PW	14	2000	RoHS & Green	NIPDAU SN	Level-1-260C-UNLIM	-40 to 125	LV125A	Samples
SN74LV125APWRE4	ACTIVE	TSSOP	PW	14	2000	RoHS & Green	NIPDAU	Level-1-260C-UNLIM	-40 to 125	LV125A	Samples
SN74LV125APWRG4	ACTIVE	TSSOP	PW	14	2000	RoHS & Green	NIPDAU	Level-1-260C-UNLIM	-40 to 125	LV125A	Samples
SN74LV125APWT	OBSOLETE	TSSOP	PW	14		TBD	Call TI	Call TI	-40 to 125	LV125A	
SN74LV125ARGYR	ACTIVE	VQFN	RGY	14	3000	RoHS & Green	NIPDAU	Level-2-260C-1 YEAR	-40 to 125	LV125A	Samples
SN74LV125ARGYRG4	ACTIVE	VQFN	RGY	14	3000	RoHS & Green	NIPDAU	Level-2-260C-1 YEAR	-40 to 125	LV125A	Samples

(1) The marketing status values are defined as follows:

ACTIVE: Product device recommended for new designs.

LIFEBUY: TI has announced that the device will be discontinued, and a lifetime-buy period is in effect.

NRND: Not recommended for new designs. Device is in production to support existing customers, but TI does not recommend using this part in a new design.

PREVIEW: Device has been announced but is not in production. Samples may or may not be available.

OBSOLETE: TI has discontinued the production of the device.

(2) **RoHS:** TI defines "RoHS" to mean semiconductor products that are compliant with the current EU RoHS requirements for all 10 RoHS substances, including the requirement that RoHS substance do not exceed 0.1% by weight in homogeneous materials. Where designed to be soldered at high temperatures, "RoHS" products are suitable for use in specified lead-free processes. TI may reference these types of products as "Pb-Free".

RoHS Exempt: TI defines "RoHS Exempt" to mean products that contain lead but are compliant with EU RoHS pursuant to a specific EU RoHS exemption.

Green: TI defines "Green" to mean the content of Chlorine (Cl) and Bromine (Br) based flame retardants meet JS709B low halogen requirements of <=1000ppm threshold. Antimony trioxide based flame retardants must also meet the <=1000ppm threshold requirement.

- (3) MSL, Peak Temp. - The Moisture Sensitivity Level rating according to the JEDEC industry standard classifications, and peak solder temperature.
- (4) There may be additional marking, which relates to the logo, the lot trace code information, or the environmental category on the device.
- (5) Multiple Device Markings will be inside parentheses. Only one Device Marking contained in parentheses and separated by a "~" will appear on a device. If a line is indented then it is a continuation of the previous line and the two combined represent the entire Device Marking for that device.
- (6) Lead finish/Ball material - Orderable Devices may have multiple material finish options. Finish options are separated by a vertical ruled line. Lead finish/Ball material values may wrap to two lines if the finish value exceeds the maximum column width.

Important Information and Disclaimer:The information provided on this page represents TI's knowledge and belief as of the date that it is provided. TI bases its knowledge and belief on information provided by third parties, and makes no representation or warranty as to the accuracy of such information. Efforts are underway to better integrate information from third parties. TI has taken and continues to take reasonable steps to provide representative and accurate information but may not have conducted destructive testing or chemical analysis on incoming materials and chemicals. TI and TI suppliers consider certain information to be proprietary, and thus CAS numbers and other limited information may not be available for release.

In no event shall TI's liability arising out of such information exceed the total purchase price of the TI part(s) at issue in this document sold by TI to Customer on an annual basis.

OTHER QUALIFIED VERSIONS OF SN74LV125A :

- Automotive : [SN74LV125A-Q1](#)

NOTE: Qualified Version Definitions:

- Automotive - Q100 devices qualified for high-reliability automotive applications targeting zero defects

TAPE AND REEL INFORMATION

QUADRANT ASSIGNMENTS FOR PIN 1 ORIENTATION IN TAPE

*All dimensions are nominal

Device	Package Type	Package Drawing	Pins	SPQ	Reel Diameter (mm)	Reel Width W1 (mm)	A0 (mm)	B0 (mm)	K0 (mm)	P1 (mm)	W (mm)	Pin1 Quadrant
SN74LV125ADBR	SSOP	DB	14	2000	330.0	16.4	8.35	6.6	2.4	12.0	16.0	Q1
SN74LV125ADGVR	TVSOP	DGV	14	2000	330.0	12.4	6.8	4.0	1.6	8.0	12.0	Q1
SN74LV125ADR	SOIC	D	14	2500	330.0	16.4	6.5	9.0	2.1	8.0	16.0	Q1
SN74LV125ADR	SOIC	D	14	2500	330.0	16.4	6.5	9.0	2.1	8.0	16.0	Q1
SN74LV125ANSR	SO	NS	14	2000	330.0	16.4	8.2	10.5	2.5	12.0	16.0	Q1
SN74LV125APWR	TSSOP	PW	14	2000	330.0	12.4	6.9	5.6	1.6	8.0	12.0	Q1
SN74LV125APWR	TSSOP	PW	14	2000	330.0	12.4	6.9	5.6	1.6	8.0	12.0	Q1
SN74LV125ARGYR	VQFN	RGY	14	3000	330.0	12.4	3.75	3.75	1.15	8.0	12.0	Q1

TAPE AND REEL BOX DIMENSIONS

*All dimensions are nominal

Device	Package Type	Package Drawing	Pins	SPQ	Length (mm)	Width (mm)	Height (mm)
SN74LV125ADBR	SSOP	DB	14	2000	356.0	356.0	35.0
SN74LV125ADGVR	TVSOP	DGV	14	2000	356.0	356.0	35.0
SN74LV125ADR	SOIC	D	14	2500	356.0	356.0	35.0
SN74LV125ADR	SOIC	D	14	2500	356.0	356.0	35.0
SN74LV125ANSR	SO	NS	14	2000	356.0	356.0	35.0
SN74LV125APWR	TSSOP	PW	14	2000	356.0	356.0	35.0
SN74LV125APWR	TSSOP	PW	14	2000	356.0	356.0	35.0
SN74LV125ARGYR	VQFN	RGY	14	3000	356.0	356.0	35.0

TUBE

*All dimensions are nominal

Device	Package Name	Package Type	Pins	SPQ	L (mm)	W (mm)	T (μm)	B (mm)
SN74LV125AN	N	PDIP	14	25	506	13.97	11230	4.32

DGV (R-PDSO-G**)

PLASTIC SMALL-OUTLINE

24 PINS SHOWN



4073251/E 08/00

- NOTES: A. All linear dimensions are in millimeters.
 B. This drawing is subject to change without notice.
 C. Body dimensions do not include mold flash or protrusion, not to exceed 0,15 per side.
 D. Falls within JEDEC: 24/48 Pins – MO-153
 14/16/20/56 Pins – MO-194

DB0014A



PACKAGE OUTLINE

SSOP - 2 mm max height

SMALL OUTLINE PACKAGE



NOTES:

1. All linear dimensions are in millimeters. Any dimensions in parenthesis are for reference only. Dimensioning and tolerancing per ASME Y14.5M.
2. This drawing is subject to change without notice.
3. This dimension does not include mold flash, protrusions, or gate burrs. Mold flash, protrusions, or gate burrs shall not exceed 0.15 mm per side.
4. Reference JEDEC registration MO-150.

EXAMPLE BOARD LAYOUT

DB0014A

SSOP - 2 mm max height

SMALL OUTLINE PACKAGE



LAND PATTERN EXAMPLE
EXPOSED METAL SHOWN
SCALE: 10X



4220762/A 05/2024

NOTES: (continued)

- 5. Publication IPC-7351 may have alternate designs.
- 6. Solder mask tolerances between and around signal pads can vary based on board fabrication site.

EXAMPLE STENCIL DESIGN

DB0014A

SSOP - 2 mm max height

SMALL OUTLINE PACKAGE



SOLDER PASTE EXAMPLE
BASED ON 0.125 mm THICK STENCIL
SCALE: 10X

4220762/A 05/2024

NOTES: (continued)

7. Laser cutting apertures with trapezoidal walls and rounded corners may offer better paste release. IPC-7525 may have alternate design recommendations.
8. Board assembly site may have different recommendations for stencil design.

N (R-PDIP-T**)

PLASTIC DUAL-IN-LINE PACKAGE

16 PINS SHOWN



- NOTES:
- A. All linear dimensions are in inches (millimeters).
 - B. This drawing is subject to change without notice.
 - Falls within JEDEC MS-001, except 18 and 20 pin minimum body length (Dim A).
 - The 20 pin end lead shoulder width is a vendor option, either half or full width.

PW0014A



PACKAGE OUTLINE
TSSOP - 1.2 mm max height

SMALL OUTLINE PACKAGE



NOTES:

1. All linear dimensions are in millimeters. Any dimensions in parenthesis are for reference only. Dimensioning and tolerancing per ASME Y14.5M.
2. This drawing is subject to change without notice.
3. This dimension does not include mold flash, protrusions, or gate burrs. Mold flash, protrusions, or gate burrs shall not exceed 0.15 mm per side.
4. This dimension does not include interlead flash. Interlead flash shall not exceed 0.25 mm per side.
5. Reference JEDEC registration MO-153.

EXAMPLE BOARD LAYOUT

PW0014A

TSSOP - 1.2 mm max height

SMALL OUTLINE PACKAGE



LAND PATTERN EXAMPLE
EXPOSED METAL SHOWN
SCALE: 10X



4220202/B 12/2023

NOTES: (continued)

- 6. Publication IPC-7351 may have alternate designs.
- 7. Solder mask tolerances between and around signal pads can vary based on board fabrication site.

EXAMPLE STENCIL DESIGN

PW0014A

TSSOP - 1.2 mm max height

SMALL OUTLINE PACKAGE



SOLDER PASTE EXAMPLE
BASED ON 0.125 mm THICK STENCIL
SCALE: 10X

4220202/B 12/2023

NOTES: (continued)

8. Laser cutting apertures with trapezoidal walls and rounded corners may offer better paste release. IPC-7525 may have alternate design recommendations.
9. Board assembly site may have different recommendations for stencil design.



D0014A

PACKAGE OUTLINE

SOIC - 1.75 mm max height

SMALL OUTLINE INTEGRATED CIRCUIT



4220718/A 09/2016

NOTES:

1. All linear dimensions are in millimeters. Dimensions in parenthesis are for reference only. Dimensioning and tolerancing per ASME Y14.5M.
2. This drawing is subject to change without notice.
3. This dimension does not include mold flash, protrusions, or gate burrs. Mold flash, protrusions, or gate burrs shall not exceed 0.15 mm, per side.
4. This dimension does not include interlead flash. Interlead flash shall not exceed 0.43 mm, per side.
5. Reference JEDEC registration MS-012, variation AB.

EXAMPLE BOARD LAYOUT

D0014A

SOIC - 1.75 mm max height

SMALL OUTLINE INTEGRATED CIRCUIT



LAND PATTERN EXAMPLE
SCALE:8X



SOLDER MASK DETAILS

4220718/A 09/2016

NOTES: (continued)

- 6. Publication IPC-7351 may have alternate designs.
- 7. Solder mask tolerances between and around signal pads can vary based on board fabrication site.

EXAMPLE STENCIL DESIGN

D0014A

SOIC - 1.75 mm max height

SMALL OUTLINE INTEGRATED CIRCUIT



SOLDER PASTE EXAMPLE
BASED ON 0.125 mm THICK STENCIL
SCALE:8X

4220718/A 09/2016

NOTES: (continued)

8. Laser cutting apertures with trapezoidal walls and rounded corners may offer better paste release. IPC-7525 may have alternate design recommendations.
9. Board assembly site may have different recommendations for stencil design.

RGY (S-PVQFN-N14)

PLASTIC QUAD FLATPACK NO-LEAD



- NOTES:
- A. All linear dimensions are in millimeters. Dimensioning and tolerancing per ASME Y14.5M-1994.
 - B. This drawing is subject to change without notice.
 - C. QFN (Quad Flatpack No-Lead) package configuration.
 - D. The package thermal pad must be soldered to the board for thermal and mechanical performance.
 - E. See the additional figure in the Product Data Sheet for details regarding the exposed thermal pad features and dimensions.
 -  Pin 1 identifiers are located on both top and bottom of the package and within the zone indicated. The Pin 1 identifiers are either a molded, marked, or metal feature.
 - G. Package complies to JEDEC MO-241 variation BA.

RGY (S-PVQFN-N14)

PLASTIC QUAD FLATPACK NO-LEAD

THERMAL INFORMATION

This package incorporates an exposed thermal pad that is designed to be attached directly to an external heatsink. The thermal pad must be soldered directly to the printed circuit board (PCB). After soldering, the PCB can be used as a heatsink. In addition, through the use of thermal vias, the thermal pad can be attached directly to the appropriate copper plane shown in the electrical schematic for the device, or alternatively, can be attached to a special heatsink structure designed into the PCB. This design optimizes the heat transfer from the integrated circuit (IC).

For information on the Quad Flatpack No-Lead (QFN) package and its advantages, refer to Application Report, QFN/SON PCB Attachment, Texas Instruments Literature No. SLUA271. This document is available at www.ti.com.

The exposed thermal pad dimensions for this package are shown in the following illustration.

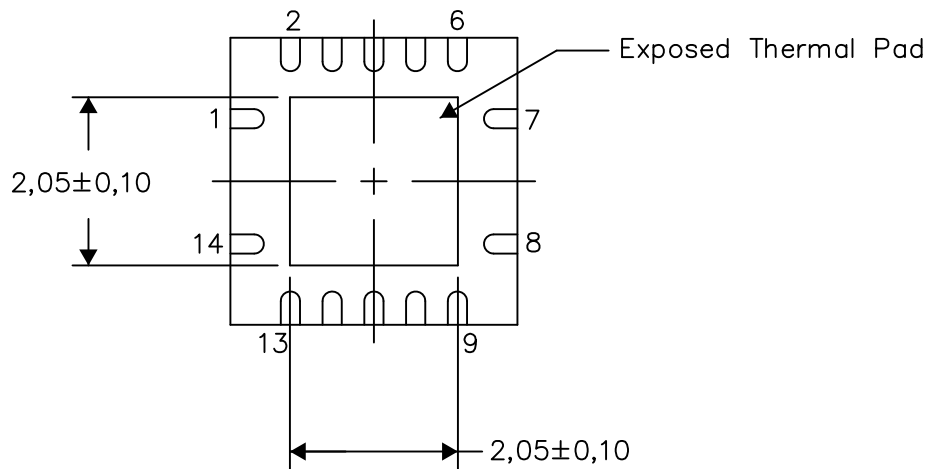

Bottom View

Exposed Thermal Pad Dimensions

4206353-2/P 03/14

NOTE: All linear dimensions are in millimeters

RGY (S-PVQFN-N14)

PLASTIC QUAD FLATPACK NO-LEAD



4208122-2/P 03/14

- NOTES:
- All linear dimensions are in millimeters.
 - This drawing is subject to change without notice.
 - Publication IPC-7351 is recommended for alternate designs.
 - This package is designed to be soldered to a thermal pad on the board. Refer to Application Note, Quad Flat-Pack QFN/SON PCB Attachment, Texas Instruments Literature No. SLUA271, and also the Product Data Sheets for specific thermal information, via requirements, and recommended board layout. These documents are available at www.ti.com <<http://www.ti.com>>.
 - Laser cutting apertures with trapezoidal walls and also rounding corners will offer better paste release. Customers should contact their board assembly site for stencil design recommendations. Refer to IPC 7525 for stencil design considerations.
 - Customers should contact their board fabrication site for minimum solder mask web tolerances between signal pads.

MECHANICAL DATA

NS (R-PDSO-G**)

PLASTIC SMALL-OUTLINE PACKAGE

14-PINS SHOWN



- NOTES:
- A. All linear dimensions are in millimeters.
 - B. This drawing is subject to change without notice.
 - C. Body dimensions do not include mold flash or protrusion, not to exceed 0,15.

IMPORTANT NOTICE AND DISCLAIMER

TI PROVIDES TECHNICAL AND RELIABILITY DATA (INCLUDING DATA SHEETS), DESIGN RESOURCES (INCLUDING REFERENCE DESIGNS), APPLICATION OR OTHER DESIGN ADVICE, WEB TOOLS, SAFETY INFORMATION, AND OTHER RESOURCES "AS IS" AND WITH ALL FAULTS, AND DISCLAIMS ALL WARRANTIES, EXPRESS AND IMPLIED, INCLUDING WITHOUT LIMITATION ANY IMPLIED WARRANTIES OF MERCHANTABILITY, FITNESS FOR A PARTICULAR PURPOSE OR NON-INFRINGEMENT OF THIRD PARTY INTELLECTUAL PROPERTY RIGHTS.

These resources are intended for skilled developers designing with TI products. You are solely responsible for (1) selecting the appropriate TI products for your application, (2) designing, validating and testing your application, and (3) ensuring your application meets applicable standards, and any other safety, security, regulatory or other requirements.

These resources are subject to change without notice. TI grants you permission to use these resources only for development of an application that uses the TI products described in the resource. Other reproduction and display of these resources is prohibited. No license is granted to any other TI intellectual property right or to any third party intellectual property right. TI disclaims responsibility for, and you will fully indemnify TI and its representatives against, any claims, damages, costs, losses, and liabilities arising out of your use of these resources.

TI's products are provided subject to [TI's Terms of Sale](#) or other applicable terms available either on [ti.com](https://www.ti.com) or provided in conjunction with such TI products. TI's provision of these resources does not expand or otherwise alter TI's applicable warranties or warranty disclaimers for TI products.

TI objects to and rejects any additional or different terms you may have proposed.

Mailing Address: Texas Instruments, Post Office Box 655303, Dallas, Texas 75265
Copyright © 2024, Texas Instruments Incorporated