

SN74LV1T00 Single Power Supply 2-Input Positive NAND Gate CMOS Logic Level Shifter

1 Features

- Single-supply voltage translator at 5.0/3.3/2.5/1.8V V_{CC}
 - Operating range of 1.8V to 5.5V
 - Up translation:
 - 1.2V¹ to 1.8V
 - 1.5V¹ to 2.5V
 - 1.8V¹ to 3.3V
 - 3.3V¹ to 5.0V
 - Down translation:
 - 5.0V, 3.3V, 2.5V to 1.8V
 - 5.0V, 3.3V to 2.5V
 - 5.0V to 3.3V
 - Logic output is referenced to V_{CC}
 - Output drive
 - 8mA output drive at 5V
 - 7mA output drive at 3.3V
 - 3mA output drive at 1.8V
 - Characterized up to 50MHz at 3.3V V_{CC}
 - 5V tolerance on input pins
 - –40°C to 125°C operating temperature range
 - Pb-free packages available: SC-70 (DCK)
 - 2 × 2.1 × 0.65mm
 - Latch-up performance exceeds 250mA order number package body size per JESD 17
 - Supports standard Logic pinouts
 - CMOS output B compatible with AUP1G and LVC1G families
1. Refer to the V_{IH}/V_{IL} and output drive for lower V_{CC} condition.

2 Applications

- Industrial controllers
- Telecom
- Portable applications
- Servers
- PC and notebooks
- Automotive

3 Description

SN74LV1T00 is a low voltage CMOS gate logic that operates at a wider voltage range for industrial, portable, telecom, and automotive applications. The output level is referenced to the supply voltage and is able to support 1.8V/2.5V/3.3V/5V CMOS levels

The input is designed with a lower threshold circuit to match 1.8V input logic at $V_{CC} = 3.3V$ and can be used in 1.8V to 3.3V level up translation. In addition, the 5V tolerant input pins enable down translation (e.g. 3.3V to 2.5V output at $V_{CC} = 2.5V$). The wide V_{CC} range of 1.8V to 5.5V allows generation of desired output levels to connect to controllers or processors.

The SN74LV1T00 is designed with current-drive capability of 8 mA to reduce line reflections, overshoot, and undershoot caused by high-drive outputs.

Package Information

DEVICE NUMBER	PACKAGE ⁽¹⁾	PACKAGE SIZE ⁽²⁾	BODY SIZE ⁽³⁾
SN74LV1T00	DBV (SOT-23, 5)	2.9mm x 2.8mm	2.9mm x 1.6mm
	DCK (SC-70, 5)	2mm x 2.1mm	2mm x 1.25mm

(1) For more information, see [Section 12](#).

(2) The package size (length × width) is a nominal value and includes pins, where applicable.

(3) The body size (length × width) is a nominal value and does not include pins.



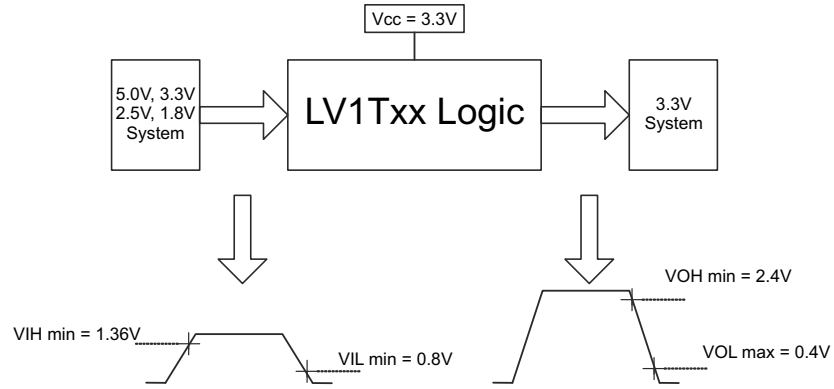

Switching Thresholds for 1.8V to 3.3V Translation

Table of Contents

1 Features	1	8.1 Overview	11
2 Applications	1	8.2 Functional Block Diagram	11
3 Description	1	8.3 Feature Description	11
4 Related Products	4	8.4 Device Functional Modes	14
5 Pin Configuration and Functions	5	9 Application and Implementation	15
6 Specifications	6	9.1 Power Supply Recommendations	15
6.1 Absolute Maximum Ratings.....	6	9.2 Layout	15
6.2 ESD Ratings.....	6	10 Device and Documentation Support	16
6.3 Recommended Operating Conditions.....	6	10.1 Receiving Notification of Documentation Updates ..	16
6.4 Thermal Information.....	7	10.2 Support Resources	16
6.5 Electrical Characteristics.....	7	10.3 Trademarks	16
6.6 Switching Characteristics.....	8	10.4 Electrostatic Discharge Caution	16
6.7 Operating Characteristics.....	8	10.5 Glossary	16
6.8 Typical Characteristics.....	8	11 Revision History	16
7 Parameter Measurement Information	10	12 Mechanical, Packaging, and Orderable Information	16
8 Detailed Description	11		

4 Related Products

DEVICE	PACKAGE	DESCRIPTION
SN74LV1T00	DCK, DBV	2-Input Positive-NAND Gate
SN74LV1T02	DCK, DBV	2-Input Positive-NOR Gate
SN74LV1T04	DCK, DBV	Inverter Gate
SN74LV1T08	DCK, DBV	2-Input Positive-AND Gate
SN74LV1T17	DCK, DBV	Single Schmitt-Trigger Buffer Gate
SN74LV1T14	DCK, DBV	Single Schmitt-Trigger Inverter Gate
SN74LV1T32	DCK, DBV	2-Input Positive-OR Gate
SN74LV1T34	DCK, DBV	Single Buffer Gate
SN74LV1T86	DCK, DBV	Single 2-Input Exclusive-Or Gate
SN74LV1T125	DCK, DBV	Single Buffer Gate with 3-state Output
SN74LV1T126	DCK, DBV	Single Buffer Gate with 3-state Output
SN74LV4T125	RGY, PW	Quadruple Bus Buffer Gate With 3-State Outputs

5 Pin Configuration and Functions

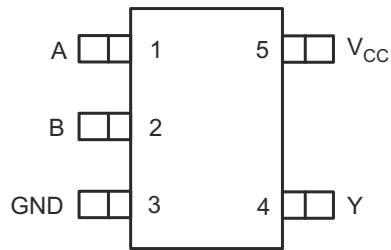

Figure 5-1. DCK or DBV Package, 5-Pin SC70 or SOT-23 (Top View)

Table 5-1. Pin Functions

PIN		TYPE ⁽¹⁾	DESCRIPTION
NAME	NO.		
A	1	I	Input A
B	2	I	Input B
GND	3	G	Ground
Y	4	O	Output Y
V _{CC}	5	P	Positive supply

(1) I = Input, O = Output, I/O = Input or Output, G = Ground, P = Power.

6 Specifications

6.1 Absolute Maximum Ratings

over operating free-air temperature range (unless otherwise noted)⁽¹⁾

		MIN	MAX	UNIT
V _{CC}	Supply voltage range	-0.5	7.0	V
V _I	Input voltage range ⁽²⁾	-0.5	7.0	V
V _O	Voltage range applied to any output in the high-impedance or power-off state ⁽²⁾	-0.5	4.6	V
	Voltage range applied to any output in the high or low state ⁽²⁾	-0.5	V _{CC} + 0.5	V
I _{IK}	Input clamp current	V _I < 0		-20 mA
I _{OK}	Output clamp current	V _O < 0 or V _O > V _{CC}		±20 mA
I _O	Continuous output current			±25 mA
	Continuous current through V _{CC} or GND			±50 mA
T _J	Junction temperature			150 °C
T _{stg}	Storage temperature	-65	150	°C

- (1) Stresses beyond those listed under *Absolute Maximum Ratings* may cause permanent damage to the device. These are stress ratings only, and functional operation of the device at these or any other conditions beyond those indicated under *Recommended Operating Conditions* is not implied. Exposure to absolute-maximum-rated conditions for extended periods may affect device reliability.
- (2) The input negative-voltage and output voltage ratings may be exceeded if the input and output current ratings are observed.

6.2 ESD Ratings

		VALUE	UNIT
V _(ESD)	Electrostatic discharge	Human-body model (HBM), per ANSI/ESDA/ JEDEC JS-001 ⁽¹⁾	±2000
		Machine Model (MM), per JEDEC specification	±200
		Charged-device model (CDM), per ANSI/ESDA/ JEDEC JS-002 ⁽²⁾	±1000

- (1) JEDEC document JEP155 states that 500-V HBM allows safe manufacturing with a standard ESD control process.
- (2) JEDEC document JEP157 states that 250-V CDM allows safe manufacturing with a standard ESD control process.

6.3 Recommended Operating Conditions

over operating free-air temperature range (unless otherwise noted)⁽¹⁾

		MIN	MAX	UNIT
V _{CC}	Supply voltage	1.6	5.5	V
V _I	Input voltage	0	5.5	V
V _O	Output voltage	0	V _{CC}	V
I _{OH}	High-level output current	V _{CC} = 1.8 V	-3	mA
		V _{CC} = 2.5 V	-5	
		V _{CC} = 3.3 V	-7	
		V _{CC} = 5.0 V	-8	
I _{OL}	Low-level output current	V _{CC} = 1.8 V	3	mA
		V _{CC} = 2.5 V	5	
		V _{CC} = 3.3 V	7	
		V _{CC} = 5.0 V	8	
Δt/Δv	Input transition rise or fall rate	V _{CC} = 1.8 V	20	ns/V
		V _{CC} = 3.3 V or 2.5 V	20	
		V _{CC} = 5.0 V	20	

over operating free-air temperature range (unless otherwise noted) ⁽¹⁾

		MIN	MAX	UNIT
T _A	Operating free-air temperature	-40	125	°C

(1) All unused inputs of the device must be held at V_{CC} or GND to ensure proper device operation. Refer to the TI application report, *Implications of Slow or Floating CMOS Inputs*, literature number [SCBA004](#).

6.4 Thermal Information

THERMAL METRIC ⁽¹⁾		DBV	DCK	UNIT
		5 PINS	5 PINS	
R _{θJA}	Junction-to-ambient thermal resistance	278	289.2	°C/W

(1) For more information about traditional and new thermal metrics, see the *IC Package Thermal Metrics* application report, [SPRA953](#).

6.5 Electrical Characteristics

over recommended operating free-air temperature range (unless otherwise noted)

PARAMETER	TEST CONDITIONS	V _{CC}	T _A = 25°C			T _A = -40°C to 125°C		UNIT
			MIN	TYP	MAX	MIN	MAX	
V _{IH} High-level input voltage		V _{CC} = 1.65 V to 1.8 V	0.94			1.0		V
		V _{CC} = 2.0 V	1.02			1.03		
		V _{CC} = 2.25 V to 2.5 V	1.135			1.18		
		V _{CC} = 2.75 V	1.21			1.23		
		V _{CC} = 3 V to 3.3 V	1.35			1.37		
		V _{CC} = 3.6 V	1.47			1.48		
		V _{CC} = 4.5 V to 5.0 V	2.02			2.03		
V _{IL} Low-level input voltage		V _{CC} = 1.65 V to 2.0 V				0.58	0.55	V
		V _{CC} = 2.25 V to 2.75 V				0.75	0.71	
		V _{CC} = 3 V to 3.6 V				0.8	0.65	
		V _{CC} = 4.5 V to 5.5 V				0.8	0.8	
V _{OH}	I _{OH} = -20 μA	1.65 V to 5.5 V	V _{CC} - 0.1			V _{CC} - 0.1		V
	I _{OH} = -2.0 mA	1.65 V	1.28			1.21		
		1.8 V	1.5			1.45		
	I _{OH} = -2.3 mA	2.3 V	2			2		
			2			1.93		
	I _{OH} = -3 mA	2.5 V	2.25			2.15		
			2.78			2.7		
	I _{OH} = -3.0 mA	3.0 V	2.6			2.49		
			2.9			2.8		
	I _{OH} = -5.5 mA	3.3 V	4.2			4.1		
			4.1			3.95		
I _{OH} = -8 mA	4.5 V	4.1			3.95			
		4.6			4.5			
V _{OL}	I _{OL} = 20 μA	1.65 V to 5.5 V				0.1	0.1	V
						0.2	0.25	
	I _{OL} = 1.9 mA	1.65 V				0.1	0.15	
						0.15	0.2	
	I _{OH} = 2.3 mA	2.3 V				0.1	0.15	
						0.1	0.15	
	I _{OH} = 3 mA	3.0 V				0.1	0.15	
						0.2	0.252	
I _{OL} = 3 mA	3.0 V				0.1	0.15		
					0.2	0.252		
I _{OL} = 5.5 mA	4.5 V				0.15	0.2		
					0.15	0.2		
I _{OL} = 4 mA	4.5 V				0.15	0.2		
					0.3	0.35		
I _{OL} = 8 mA	4.5 V				0.15	0.2		
					0.3	0.35		
I _I A input	V _I = 0 V or V _{CC}	0 V, 1.8 V, 2.5 V, 3.3 V, 5.5 V				0.12	±1	μA

over recommended operating free-air temperature range (unless otherwise noted)

PARAMETER	TEST CONDITIONS	V _{CC}	T _A = 25°C			T _A = -40°C to 125°C		UNIT	
			MIN	TYP	MAX	MIN	MAX		
I _{CC}	V _I = 0 V or V _{CC} , I _O = 0; open on loading	5.0 V			1		10	μA	
		3.3 V			1		10		
		2.5 V			1		10		
		1.8 V			1		10		
ΔI _{CC}	One input at 0.3 V or 3.4 V, Other inputs at 0 or V _{CC} , I _O = 0	5.5 V			1.35		1.5	mA	
	One input at 0.3 V or 1.1 V Other inputs at 0 or V _{CC} , I _O = 0	1.8 V			10		10	μA	
C _i	V _I = V _{CC} or GND	3.3 V		2	10		2	10	pF
C _o	V _O = V _{CC} or GND	3.3 V		2.5			2.5		pF

6.6 Switching Characteristics

over recommended operating free-air temperature range (unless otherwise noted) (see [Parameter Measurement Information](#))

PARAMETER	FROM (INPUT)	TO (OUTPUT)	FREQUENCY (TYP)	V _{CC}	C _L	T _A = 25°C			T _A = -65°C to 125°C			UNIT
						MIN	TYP	MAX	MIN	TYP	MAX	
t _{pd}	Any In	Y	DC to 50 MHz	5.0 V	15 pF	4	5		4	5		ns
						5.5	7.0		5.5	7.0		
				3.3 V	15 pF	4.8	5		5	5.5		ns
						5	5.5		5.5	6.5		
			DC to 25 MHz	2.5 V	15 pF	6	6.5		7	7.5		ns
						6.5	7.5		7.5	8.5		
			DC to 15 MHz	1.8 V	15 pF	10.5	11		11	12		ns
						12	13		12	14		

6.7 Operating Characteristics

T_A = 25°C

PARAMETER	TEST CONDITIONS	V _{CC}	TYP	UNIT
C _{pd} Power dissipation capacitance	f = 1 MHz and 10 MHz	1.8 V ± 0.15 V	10	pF
		2.5 V ± 0.2 V	10	
		3.3 V ± 0.3 V	10	
		5.5 V ± 0.5 V	10	

6.8 Typical Characteristics

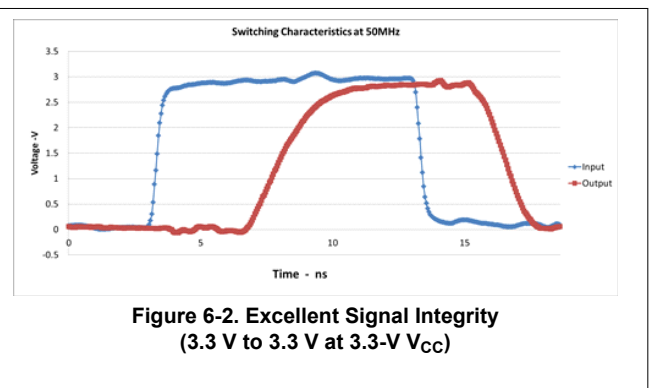
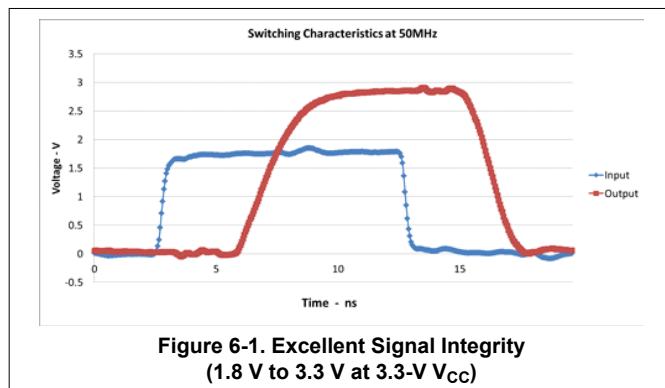

6.8 Typical Characteristics (continued)

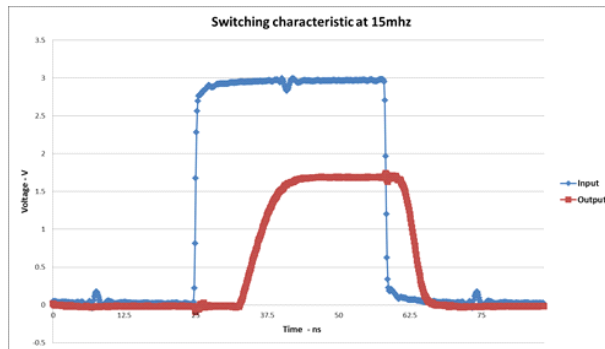

Figure 6-3. Excellent Signal Integrity
(3.3 V to 1.8 V at 1.8-V V_{CC})

7 Parameter Measurement Information

Phase relationships between waveforms were chosen arbitrarily. All input pulses are supplied by generators having the following characteristics: $PRR \leq 1 \text{ MHz}$, $Z_O = 50 \ \Omega$.

For clock inputs, f_{max} is measured when the input duty cycle is 50%.

The outputs are measured one at a time with one input transition per measurement.

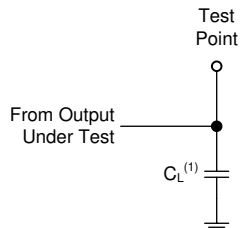

(1) C_L includes probe and test-fixture capacitance.

Figure 7-1. Load Circuit for Push-Pull Outputs

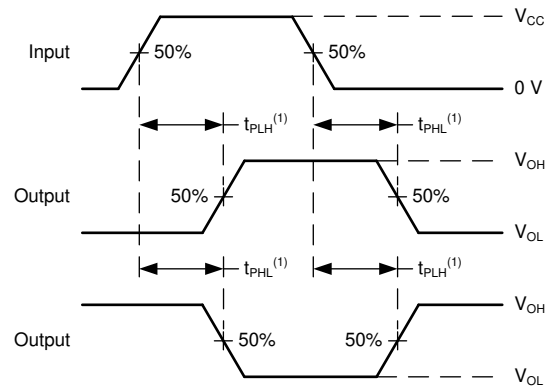

(1) The greater between t_{PLH} and t_{PHL} is the same as t_{pd} .

Figure 7-2. Voltage Waveforms Propagation Delays

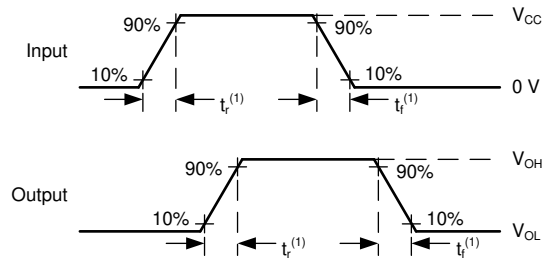

(1) The greater between t_r and t_f is the same as t_t .

Figure 7-3. Voltage Waveforms, Input and Output Transition Times

8 Detailed Description

8.1 Overview

The SN74LV1T00 contains one independent dual input NAND gate with extended voltage operation to allow for level translation. Each gate performs the Boolean function $Y = \overline{A \bullet B}$ in positive logic. The output level is referenced to the supply voltage (V_{CC}) and supports 1.8-V, 2.5-V, 3.3-V, and 5-V CMOS levels.

8.2 Functional Block Diagram

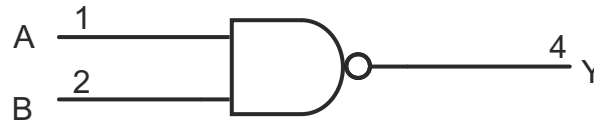

8.3 Feature Description

8.3.1 Clamp Diode Structure

As [Figure 8-1](#) shows, the outputs to this device have both positive and negative clamping diodes, and the inputs to this device have negative clamping diodes only.

CAUTION

Voltages beyond the values specified in the *Absolute Maximum Ratings* table can cause damage to the device. The input and output voltage ratings may be exceeded if the input and output clamp-current ratings are observed.

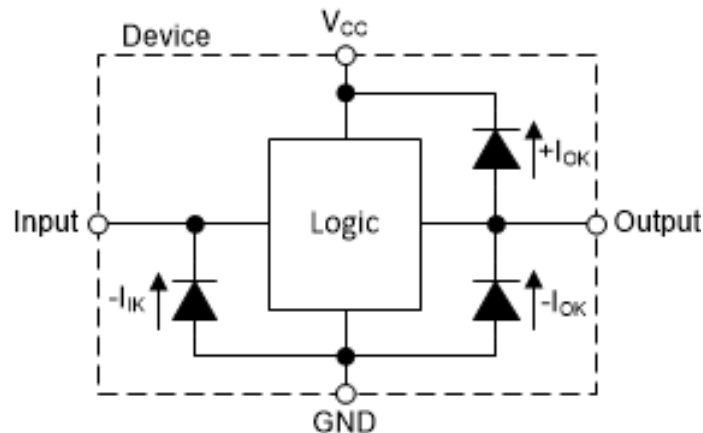

Figure 8-1. Electrical Placement of Clamping Diodes for Each Input and Output

8.3.2 Balanced CMOS Push-Pull Outputs

This device includes balanced CMOS push-pull outputs. The term *balanced* indicates that the device can sink and source similar currents. The drive capability of this device may create fast edges into light loads, so routing and load conditions should be considered to prevent ringing. Additionally, the outputs of this device are capable of driving larger currents than the device can sustain without being damaged. It is important to limit the output power of the device to avoid damage due to overcurrent. The electrical and thermal limits defined in the *Absolute Maximum Ratings* must be followed at all times.

Unused push-pull CMOS outputs must be left disconnected.

8.3.3 LVxT Enhanced Input Voltage

The SN74LV1T00 belongs to TI's LVxT family of logic devices with integrated voltage level translation. This family of devices was designed with reduced input voltage thresholds to support up-translation, and inputs tolerant of signals with up to 5.5V levels to support down-translation. For proper functionality, input signals must remain at or above the specified $V_{IH(MIN)}$ level for a HIGH input state, and at or below the specified $V_{IL(MAX)}$ for

a LOW input state. Figure 8-2 shows the typical V_{IH} and V_{IL} levels for the LVxT family of devices, as well as the voltage levels for standard CMOS devices for comparison.

The inputs are high impedance and are typically modeled as a resistor in parallel with the input capacitance given in the *Electrical Characteristics*. The worst case resistance is calculated with the maximum input voltage, given in the *Absolute Maximum Ratings*, and the maximum input leakage current, given in the *Electrical Characteristics*, using Ohm's law ($R = V \div I$).

Input signals must transition between valid logic states quickly, as defined by the input transition rate in the *Recommended Operating Conditions* table. Failing to meet this specification will result in excessive power consumption and could cause oscillations. More details can be found in the [Implications of Slow or Floating CMOS Inputs](#) application report.

Do not leave inputs floating at any time during operation. Unused inputs must be terminated at a valid high or low voltage level. If a system will not be actively driving an input at all times, then a pull-up or pull-down resistor can be added to provide a valid input voltage during these times. The resistor value will depend on multiple factors; however, a 10k Ω resistor is recommended and will typically meet all requirements.

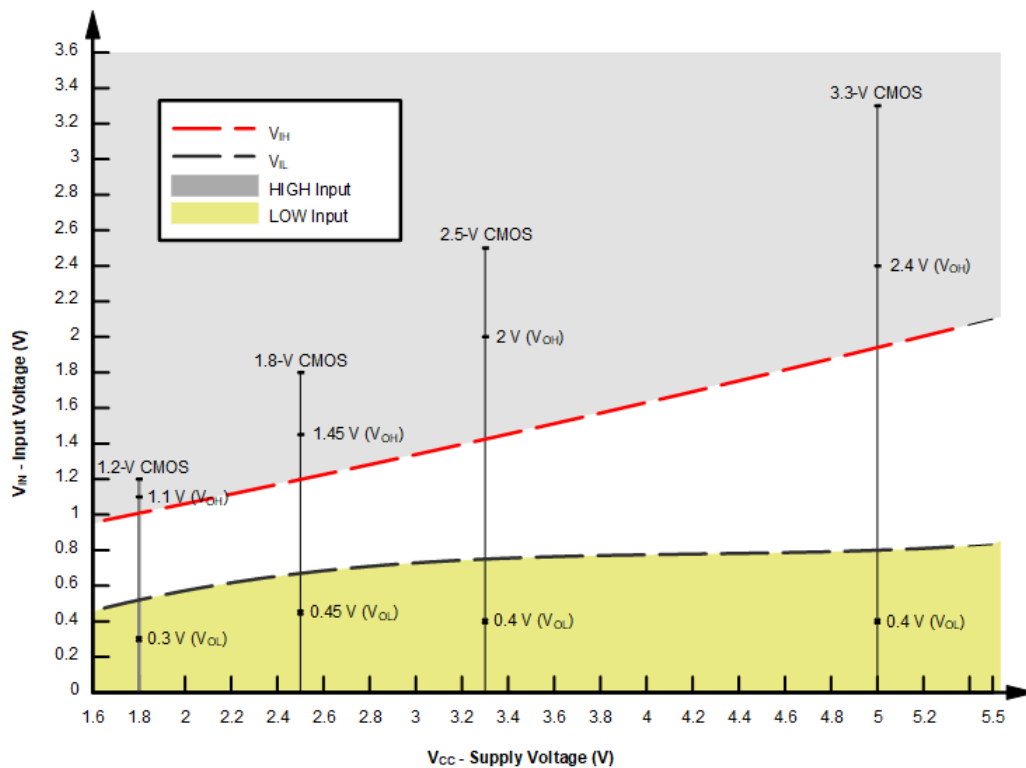

Figure 8-2. LVxT Input Voltage Levels

8.3.3.1 Down Translation

Signals can be translated down using the SN74LV1T00. The voltage applied at the V_{CC} will determine the output voltage and the input thresholds as described in the *Recommended Operating Conditions* and *Electrical Characteristics* tables.

When connected to a high-impedance input, the output voltage will be approximately V_{CC} in the HIGH state, and 0V in the LOW state. Ensure that the input signals in the HIGH state are between $V_{IH(MIN)}$ and 5.5V, and input signals in the LOW state are lower than $V_{IL(MAX)}$ as shown in Figure 8-2.

For example, standard CMOS inputs for devices operating at 5.0V, 3.3V or 2.5V can be down-translated to match 1.8V CMOS signals when operating from 1.8V V_{CC} . See Figure 8-3.

Down Translation Combinations are as follows:

- 1.8V V_{CC} – Inputs from 2.5V, 3.3V, and 5.0V
- 2.5V V_{CC} – Inputs from 3.3V and 5.0V
- 3.3V V_{CC} – Inputs from 5.0V

8.3.3.2 Up Translation

Input signals can be up translated using the SN74LV1T00. The voltage applied at V_{CC} will determine the output voltage and the input thresholds as described in the *Recommended Operating Conditions* and *Electrical Characteristics* tables. When connected to a high-impedance input, the output voltage will be approximately V_{CC} in the HIGH state, and 0V in the LOW state.

The inputs have reduced thresholds that allow for input HIGH state levels, which are much lower than standard values. For example, standard CMOS inputs for a device operating at a 5V supply will have a $V_{IH(MIN)}$ of 3.5V. For the SN74LV1T00, $V_{IH(MIN)}$ with a 5V supply is only 2V, which would allow for up-translation from a typical 2.5V to 5V signals.

Ensure that the input signals in the HIGH state are above $V_{IH(MIN)}$ and input signals in the LOW state are lower than $V_{IL(MAX)}$ as shown in [Figure 8-3](#).

Up Translation Combinations are as follows:

- 1.8V V_{CC} – Inputs from 1.2V
- 2.5V V_{CC} – Inputs from 1.8V
- 3.3V V_{CC} – Inputs from 1.8V and 2.5V
- 5.0V V_{CC} – Inputs from 2.5V and 3.3V

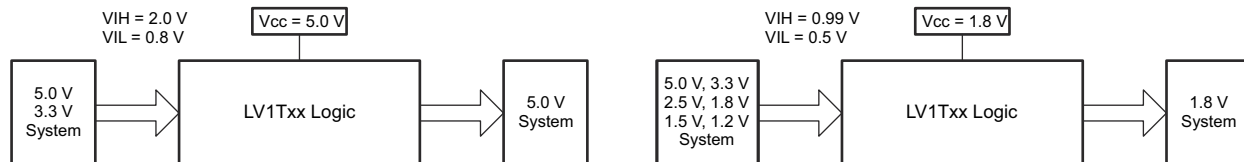

Figure 8-3. LVxT Up and Down Translation Example

8.4 Device Functional Modes

[Function Table](#) lists the functional modes of the SN74LV1T00.

Table 8-1. Function Table

INPUTS ⁽¹⁾ (Lower Level Input)		OUTPUT (V_{CC} CMOS) ⁽²⁾
A	B	Y
H	H	L
L	X	H
X	L	H
SUPPLY $V_{CC} = 3.3V$		
A	B	Y
$V_{IH(min)} = 1.35 V$		$V_{OH(min)} = 2.9 V$
$V_{IL(max)} = 0.8 V$		$V_{OL(max)} = 0.2 V$

(1) H = High Voltage Level, L = Low Voltage Level, X = Do not Care, Z = High Impedance

(2) H = Driving High, L = Driving Low, Z = High Impedance State

9 Application and Implementation

Note

Information in the following applications sections is not part of the TI component specification, and TI does not warrant its accuracy or completeness. TI's customers are responsible for determining suitability of components for their purposes, as well as validating and testing their design implementation to confirm system functionality.

9.1 Power Supply Recommendations

The power supply can be any voltage between the minimum and maximum supply voltage rating located in the *Recommended Operating Conditions*. Each V_{CC} terminal should have a good bypass capacitor to prevent power disturbance. A 0.1- μ F capacitor is recommended for this device. It is acceptable to parallel multiple bypass caps to reject different frequencies of noise. The 0.1- μ F and 1- μ F capacitors are commonly used in parallel. The bypass capacitor should be installed as close to the power terminal as possible for best results, as shown in the following layout example.

9.2 Layout

9.2.1 Layout Guidelines

When using multiple-input and multiple-channel logic devices inputs must not ever be left floating. In many cases, functions or parts of functions of digital logic devices are unused; for example, when only two inputs of a triple-input AND gate are used or only 3 of the 4 buffer gates are used. Such unused input pins must not be left unconnected because the undefined voltages at the outside connections result in undefined operational states. All unused inputs of digital logic devices must be connected to a logic high or logic low voltage, as defined by the input voltage specifications, to prevent them from floating. The logic level that must be applied to any particular unused input depends on the function of the device. Generally, the inputs are tied to GND or V_{CC} , whichever makes more sense for the logic function or is more convenient.

10 Device and Documentation Support

10.1 Receiving Notification of Documentation Updates

To receive notification of documentation updates, navigate to the device product folder on ti.com. Click on *Notifications* to register and receive a weekly digest of any product information that has changed. For change details, review the revision history included in any revised document.

10.2 Support Resources

[TI E2E™ support forums](#) are an engineer's go-to source for fast, verified answers and design help — straight from the experts. Search existing answers or ask your own question to get the quick design help you need.

Linked content is provided "AS IS" by the respective contributors. They do not constitute TI specifications and do not necessarily reflect TI's views; see TI's [Terms of Use](#).

10.3 Trademarks

TI E2E™ is a trademark of Texas Instruments.

All trademarks are the property of their respective owners.

10.4 Electrostatic Discharge Caution



This integrated circuit can be damaged by ESD. Texas Instruments recommends that all integrated circuits be handled with appropriate precautions. Failure to observe proper handling and installation procedures can cause damage.

ESD damage can range from subtle performance degradation to complete device failure. Precision integrated circuits may be more susceptible to damage because very small parametric changes could cause the device not to meet its published specifications.

10.5 Glossary

[TI Glossary](#) This glossary lists and explains terms, acronyms, and definitions.

11 Revision History

NOTE: Page numbers for previous revisions may differ from page numbers in the current version.

Changes from Revision D (March 2024) to Revision E (July 2024) Page

- Updated RθJA values: DCK = 252 to 289.2, all values in °C/W7

Changes from Revision C (June 2022) to Revision D (March 2024) Page

- Changed *Device Information* to *Package Information* and added body size to table..... 1
- Updated RθJA values: DBV = 206 to 278, all values in °C/W7

12 Mechanical, Packaging, and Orderable Information

The following packaging information and addendum reflect the most current data available for the designated devices. This data is subject to change without notice and revision of this document.

PACKAGING INFORMATION

Orderable Device	Status (1)	Package Type	Package Drawing	Pins	Package Qty	Eco Plan (2)	Lead finish/ Ball material (6)	MSL Peak Temp (3)	Op Temp (°C)	Device Marking (4/5)	Samples
SN74LV1T00DBVR	ACTIVE	SOT-23	DBV	5	3000	RoHS & Green	SN	Level-1-260C-UNLIM	-40 to 125	(37VH, 3CEF, NEA3, NEAJ, NEAS)	Samples
SN74LV1T00DBVRG4	ACTIVE	SOT-23	DBV	5	3000	RoHS & Green	NIPDAU	Level-1-260C-UNLIM	-40 to 125	NEA3	Samples
SN74LV1T00DCKR	ACTIVE	SC70	DCK	5	3000	RoHS & Green	NIPDAU SN	Level-1-260C-UNLIM	-40 to 125	(1TR, WA3, WAJ, WAS)	Samples
SN74LV1T00DCKRG4	ACTIVE	SC70	DCK	5	3000	RoHS & Green	NIPDAU	Level-1-260C-UNLIM		WA3	Samples

(1) The marketing status values are defined as follows:

ACTIVE: Product device recommended for new designs.

LIFEBUY: TI has announced that the device will be discontinued, and a lifetime-buy period is in effect.

NRND: Not recommended for new designs. Device is in production to support existing customers, but TI does not recommend using this part in a new design.

PREVIEW: Device has been announced but is not in production. Samples may or may not be available.

OBSELETE: TI has discontinued the production of the device.

(2) **RoHS:** TI defines "RoHS" to mean semiconductor products that are compliant with the current EU RoHS requirements for all 10 RoHS substances, including the requirement that RoHS substance do not exceed 0.1% by weight in homogeneous materials. Where designed to be soldered at high temperatures, "RoHS" products are suitable for use in specified lead-free processes. TI may reference these types of products as "Pb-Free".

RoHS Exempt: TI defines "RoHS Exempt" to mean products that contain lead but are compliant with EU RoHS pursuant to a specific EU RoHS exemption.

Green: TI defines "Green" to mean the content of Chlorine (Cl) and Bromine (Br) based flame retardants meet JS709B low halogen requirements of <=1000ppm threshold. Antimony trioxide based flame retardants must also meet the <=1000ppm threshold requirement.

(3) MSL, Peak Temp. - The Moisture Sensitivity Level rating according to the JEDEC industry standard classifications, and peak solder temperature.

(4) There may be additional marking, which relates to the logo, the lot trace code information, or the environmental category on the device.

(5) Multiple Device Markings will be inside parentheses. Only one Device Marking contained in parentheses and separated by a "~" will appear on a device. If a line is indented then it is a continuation of the previous line and the two combined represent the entire Device Marking for that device.

(6) Lead finish/Ball material - Orderable Devices may have multiple material finish options. Finish options are separated by a vertical ruled line. Lead finish/Ball material values may wrap to two lines if the finish value exceeds the maximum column width.

Important Information and Disclaimer:The information provided on this page represents TI's knowledge and belief as of the date that it is provided. TI bases its knowledge and belief on information provided by third parties, and makes no representation or warranty as to the accuracy of such information. Efforts are underway to better integrate information from third parties. TI has taken and

continues to take reasonable steps to provide representative and accurate information but may not have conducted destructive testing or chemical analysis on incoming materials and chemicals. TI and TI suppliers consider certain information to be proprietary, and thus CAS numbers and other limited information may not be available for release.

In no event shall TI's liability arising out of such information exceed the total purchase price of the TI part(s) at issue in this document sold by TI to Customer on an annual basis.

OTHER QUALIFIED VERSIONS OF SN74LV1T00 :

- Automotive : [SN74LV1T00-Q1](#)

NOTE: Qualified Version Definitions:

- Automotive - Q100 devices qualified for high-reliability automotive applications targeting zero defects

TAPE AND REEL INFORMATION

QUADRANT ASSIGNMENTS FOR PIN 1 ORIENTATION IN TAPE

*All dimensions are nominal

Device	Package Type	Package Drawing	Pins	SPQ	Reel Diameter (mm)	Reel Width W1 (mm)	A0 (mm)	B0 (mm)	K0 (mm)	P1 (mm)	W (mm)	Pin1 Quadrant
SN74LV1T00DBVR	SOT-23	DBV	5	3000	180.0	8.4	3.2	3.2	1.4	4.0	8.0	Q3
SN74LV1T00DBVRG4	SOT-23	DBV	5	3000	178.0	9.2	3.3	3.23	1.55	4.0	8.0	Q3
SN74LV1T00DCKR	SC70	DCK	5	3000	178.0	9.2	2.4	2.4	1.22	4.0	8.0	Q3
SN74LV1T00DCKR	SC70	DCK	5	3000	178.0	9.0	2.4	2.5	1.2	4.0	8.0	Q3
SN74LV1T00DCKRG4	SC70	DCK	5	3000	178.0	9.2	2.4	2.4	1.22	4.0	8.0	Q3

TAPE AND REEL BOX DIMENSIONS



*All dimensions are nominal

Device	Package Type	Package Drawing	Pins	SPQ	Length (mm)	Width (mm)	Height (mm)
SN74LV1T00DBVR	SOT-23	DBV	5	3000	210.0	185.0	35.0
SN74LV1T00DBVRG4	SOT-23	DBV	5	3000	180.0	180.0	18.0
SN74LV1T00DCKR	SC70	DCK	5	3000	180.0	180.0	18.0
SN74LV1T00DCKR	SC70	DCK	5	3000	180.0	180.0	18.0
SN74LV1T00DCKRG4	SC70	DCK	5	3000	180.0	180.0	18.0

DCK0005A



PACKAGE OUTLINE

SOT - 1.1 max height

SMALL OUTLINE TRANSISTOR

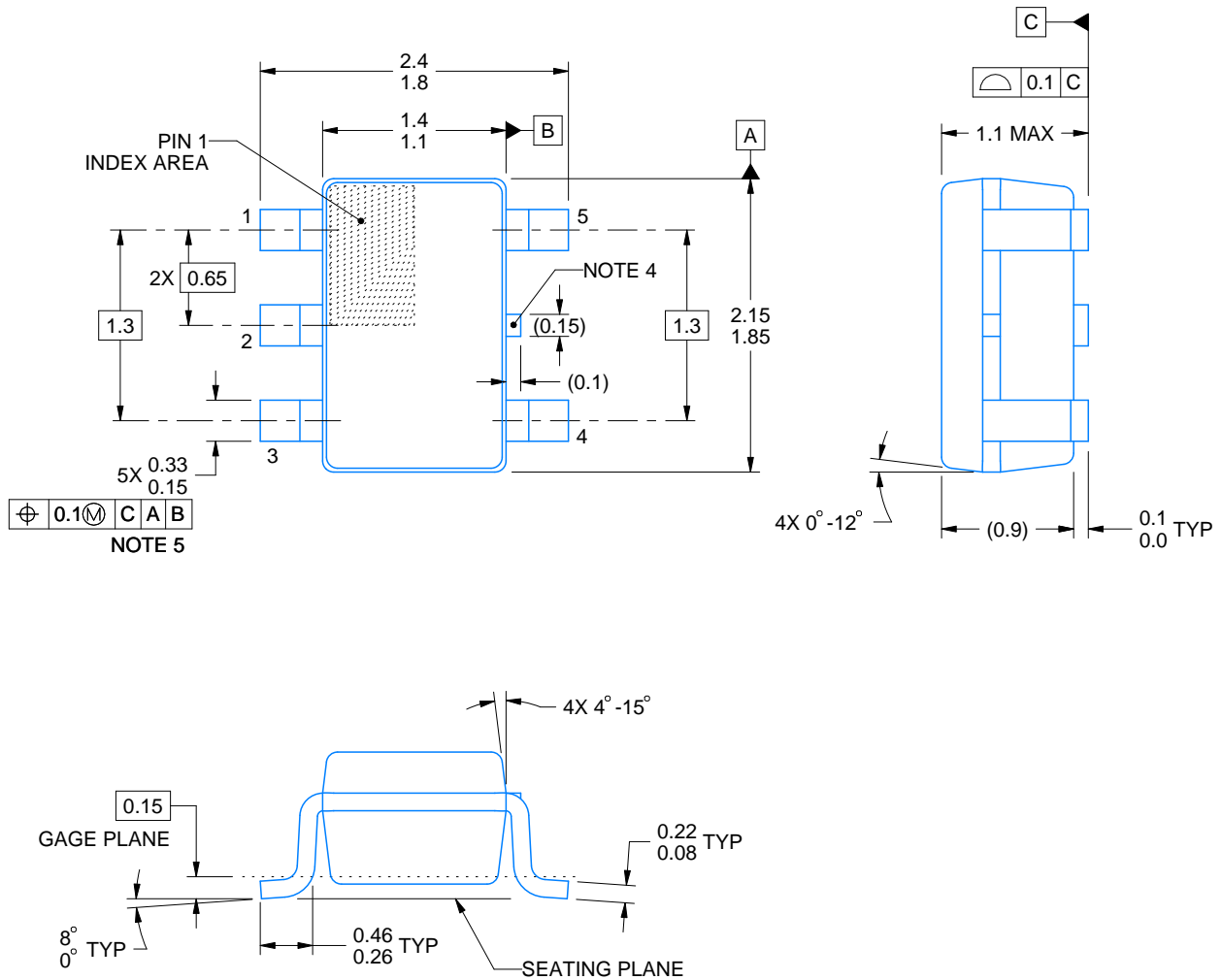

4214834/G 11/2024

NOTES:

1. All linear dimensions are in millimeters. Any dimensions in parenthesis are for reference only. Dimensioning and tolerancing per ASME Y14.5M.
2. This drawing is subject to change without notice.
3. Reference JEDEC MO-203.
4. Support pin may differ or may not be present.
5. Lead width does not comply with JEDEC.
6. Body dimensions do not include mold flash, protrusions, or gate burrs. Mold flash, protrusions, or gate burrs shall not exceed 0.25mm per side

EXAMPLE BOARD LAYOUT

DCK0005A

SOT - 1.1 max height

SMALL OUTLINE TRANSISTOR

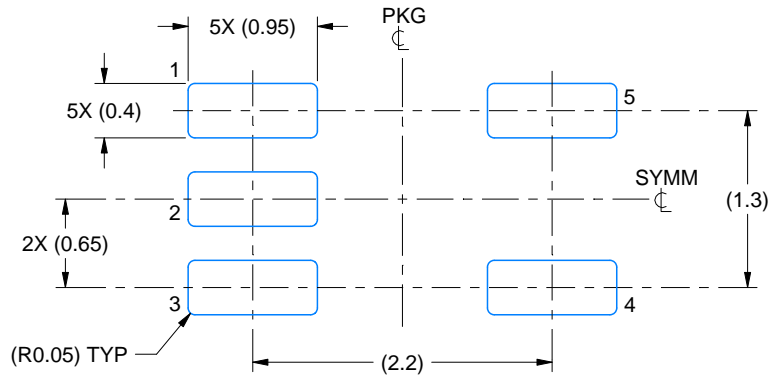

LAND PATTERN EXAMPLE
EXPOSED METAL SHOWN
SCALE:18X



SOLDER MASK DETAILS

4214834/G 11/2024

NOTES: (continued)

- 7. Publication IPC-7351 may have alternate designs.
- 8. Solder mask tolerances between and around signal pads can vary based on board fabrication site.

EXAMPLE STENCIL DESIGN

DCK0005A

SOT - 1.1 max height

SMALL OUTLINE TRANSISTOR

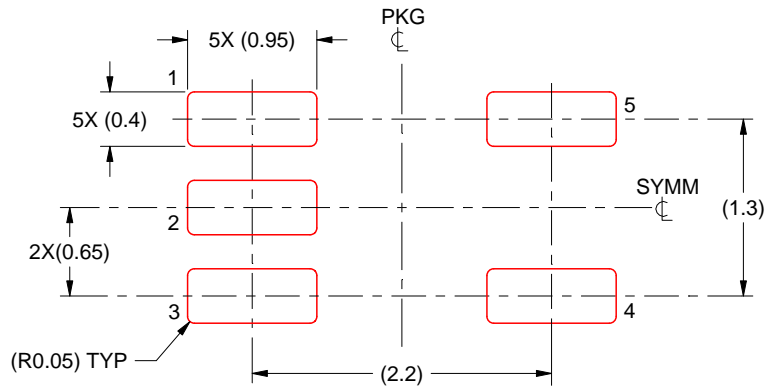

SOLDER PASTE EXAMPLE
BASED ON 0.125 THICK STENCIL
SCALE: 18X

4214834/G 11/2024

NOTES: (continued)

9. Laser cutting apertures with trapezoidal walls and rounded corners may offer better paste release. IPC-7525 may have alternate design recommendations.
10. Board assembly site may have different recommendations for stencil design.

EXAMPLE BOARD LAYOUT

DBV0005A

SOT-23 - 1.45 mm max height

SMALL OUTLINE TRANSISTOR



LAND PATTERN EXAMPLE
EXPOSED METAL SHOWN
SCALE:15X



SOLDER MASK DETAILS

4214839/K 08/2024

NOTES: (continued)

- 6. Publication IPC-7351 may have alternate designs.
- 7. Solder mask tolerances between and around signal pads can vary based on board fabrication site.

EXAMPLE STENCIL DESIGN

DBV0005A

SOT-23 - 1.45 mm max height

SMALL OUTLINE TRANSISTOR



SOLDER PASTE EXAMPLE
BASED ON 0.125 mm THICK STENCIL
SCALE:15X

4214839/K 08/2024

NOTES: (continued)

8. Laser cutting apertures with trapezoidal walls and rounded corners may offer better paste release. IPC-7525 may have alternate design recommendations.
9. Board assembly site may have different recommendations for stencil design.

IMPORTANT NOTICE AND DISCLAIMER

TI PROVIDES TECHNICAL AND RELIABILITY DATA (INCLUDING DATA SHEETS), DESIGN RESOURCES (INCLUDING REFERENCE DESIGNS), APPLICATION OR OTHER DESIGN ADVICE, WEB TOOLS, SAFETY INFORMATION, AND OTHER RESOURCES "AS IS" AND WITH ALL FAULTS, AND DISCLAIMS ALL WARRANTIES, EXPRESS AND IMPLIED, INCLUDING WITHOUT LIMITATION ANY IMPLIED WARRANTIES OF MERCHANTABILITY, FITNESS FOR A PARTICULAR PURPOSE OR NON-INFRINGEMENT OF THIRD PARTY INTELLECTUAL PROPERTY RIGHTS.

These resources are intended for skilled developers designing with TI products. You are solely responsible for (1) selecting the appropriate TI products for your application, (2) designing, validating and testing your application, and (3) ensuring your application meets applicable standards, and any other safety, security, regulatory or other requirements.

These resources are subject to change without notice. TI grants you permission to use these resources only for development of an application that uses the TI products described in the resource. Other reproduction and display of these resources is prohibited. No license is granted to any other TI intellectual property right or to any third party intellectual property right. TI disclaims responsibility for, and you will fully indemnify TI and its representatives against, any claims, damages, costs, losses, and liabilities arising out of your use of these resources.

TI's products are provided subject to [TI's Terms of Sale](#) or other applicable terms available either on [ti.com](https://www.ti.com) or provided in conjunction with such TI products. TI's provision of these resources does not expand or otherwise alter TI's applicable warranties or warranty disclaimers for TI products.

TI objects to and rejects any additional or different terms you may have proposed.

Mailing Address: Texas Instruments, Post Office Box 655303, Dallas, Texas 75265
Copyright © 2025, Texas Instruments Incorporated