

SN74LV6T17-Q1 Automotive Hex Schmitt-Trigger Buffers with Integrated Translation

1 Features

- AEC-Q100 qualified for automotive applications:
 - Device temperature grade 1: -40°C to +125°C
 - Device HBM ESD classification level 2
 - Device CDM ESD classification level C4B
- Available in [wetttable flank](#) QFN (WBQA) package
- Wide operating range of 1.8 V to 5.5 V
- Single-supply voltage translator (refer to *LVxT Enhanced Input Voltage*):
 - Up translation:
 - 1.2 V to 1.8 V
 - 1.5 V to 2.5 V
 - 1.8 V to 3.3 V
 - 3.3 V to 5.0 V
 - Down translation:
 - 5.0 V, 3.3 V, 2.5 V to 1.8 V
 - 5.0 V, 3.3 V to 2.5 V
 - 5.0 V to 3.3 V
- 5.5-V tolerant input pins
- Supports standard pinouts
- Up to 150 Mbps with 5-V or 3.3-V V_{CC}
- Latch-up performance exceeds 250 mA per JESD 17

2 Applications

- [Enable or disable a digital signal](#)
- [Controlling an indicator LED](#)
- [Translation between communication modules and system controllers](#)

3 Description

The SN74LV6T17-Q1 device contains six independent Buffers with Schmitt-trigger inputs. Each gate performs the Boolean function $Y = A$ in positive logic. The output level is referenced to the supply voltage (V_{CC}) and supports 1.8-V, 2.5-V, 3.3-V, and 5-V CMOS levels.

The input is designed with a lower threshold circuit to support up translation for lower voltage CMOS inputs (for example, 1.2 V input to 1.8 V output or 1.8 V input to 3.3 V output). In addition, the 5-V tolerant input pins enable down translation (for example, 3.3 V to 2.5 V output).

Package Information

| PART NUMBER | PACKAGE ⁽¹⁾ | PACKAGE SIZE ⁽²⁾ | BODY SIZE (NOM) ⁽³⁾ |
|---------------|------------------------|-----------------------------|--------------------------------|
| SN74LV6T17-Q1 | BQA (WQFN, 14) | 3 mm × 2.5 mm | 3 mm × 2.5 mm |
| | PW (TSSOP, 14) | 5 mm × 6.4 mm | 5 mm × 4.4 mm |

- (1) For all available packages, see the orderable addendum at the end of the data sheet.
- (2) The package size (length × width) is a nominal value and includes pins, where applicable.
- (3) The body size (length × width) is a nominal value and does not include pins.

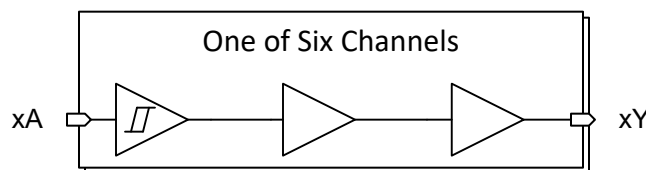

Simplified Logic Diagram (Positive Logic)



Table of Contents

| | | | |
|--|----|--|----|
| 1 Features | 1 | 9.3 Feature Description..... | 11 |
| 2 Applications | 1 | 9.4 Device Functional Modes..... | 14 |
| 3 Description | 1 | 10 Application and Implementation | 15 |
| 4 Revision History | 2 | 10.1 Application Information..... | 15 |
| 5 Pin Configuration and Functions | 3 | 10.2 Typical Application..... | 15 |
| 6 Specifications | 4 | 11 Layout | 17 |
| 6.1 Absolute Maximum Ratings..... | 4 | 11.1 Layout Guidelines..... | 17 |
| 6.2 ESD Ratings..... | 4 | 11.2 Layout Example..... | 18 |
| 6.3 Recommended Operating Conditions..... | 5 | 12 Device and Documentation Support | 19 |
| 6.4 Thermal Information..... | 5 | 12.1 Documentation Support..... | 19 |
| 6.5 Electrical Characteristics..... | 6 | 12.2 Receiving Notification of Documentation Updates.. | 19 |
| 6.6 Switching Characteristics..... | 7 | 12.3 Support Resources..... | 19 |
| 6.7 Noise Characteristics..... | 7 | 12.4 Trademarks..... | 19 |
| 7 Typical Characteristics | 7 | 12.5 Electrostatic Discharge Caution..... | 19 |
| 8 Parameter Measurement Information | 10 | 12.6 Glossary..... | 19 |
| 9 Detailed Description | 11 | 13 Mechanical, Packaging, and Orderable Information | 19 |
| 9.1 Overview..... | 11 | | |
| 9.2 Functional Block Diagram..... | 11 | | |

4 Revision History

| DATE | REVISION | NOTES |
|-----------|----------|-----------------|
| June 2023 | * | Initial Release |

5 Pin Configuration and Functions

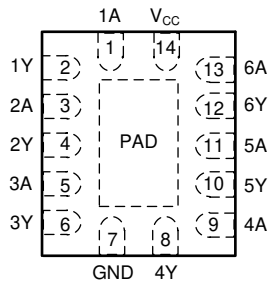

Figure 5-1. SN74LV6T17-Q1 BQA Package, 14-Pin WQFN (Top View)

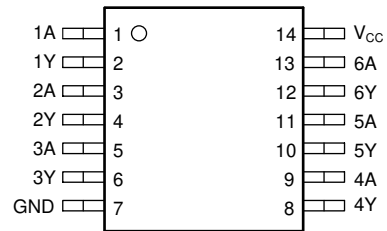

Figure 5-2. SN74LV6T17-Q1 PW Package, 14-Pin TSSOP (Top View)

Table 5-1. Pin Functions

| NAME | PIN | | TYPE ⁽¹⁾ | DESCRIPTION |
|----------------------------|-----|----|---------------------|---|
| | BQA | PW | | |
| 1A | | | I | Channel 1, Input A |
| 1Y | | | O | Channel 1, Output Y |
| 2A | | | I | Channel 2, Input A |
| 2Y | | | O | Channel 2, Output Y |
| 3A _{CC} | | | I | Channel 3, Input A |
| 3Y | | | O | Channel 3, Output Y |
| GND | | | G | Ground |
| 4Y | | | O | Channel 4, Output Y |
| 4A | | | I | Channel 4, Input A |
| 5Y | | | O | Channel 5, Output Y |
| 5A | | | I | Channel 5, Input A |
| 6Y | | | O | Channel 6, Output Y |
| 6A | | | I | Channel 6, Input A |
| V _{CC} | | | P | Positive Supply |
| Thermal Pad ⁽²⁾ | | | — | The thermal pad can be connected to GND or left floating. Do not connect to any other signal or supply. |

(1) I = input, O = output, I/O = input or output, G = ground, P = power.

(2) BQA package only.

6 Specifications

6.1 Absolute Maximum Ratings

over operating free-air temperature range (unless otherwise noted)⁽¹⁾

| | | MIN | MAX | UNIT |
|------------------|---|---|-----------------------|------|
| V _{CC} | Supply voltage range | -0.5 | 7 | V |
| V _I | Input voltage range ⁽²⁾ | -0.5 | 7 | V |
| V _O | Voltage range applied to any output in the high-impedance or power-off state ⁽²⁾ | -0.5 | 7 | V |
| V _O | Output voltage range ⁽²⁾ | -0.5 | V _{CC} + 0.5 | V |
| I _{IK} | Input clamp current | V _I < -0.5 V | -20 | mA |
| I _{OK} | Output clamp current | V _O < -0.5 V or V _O > V _{CC} + 0.5 V | ±20 | mA |
| I _O | Continuous output current | V _O = 0 to V _{CC} | ±25 | mA |
| | Continuous output current through V _{CC} or GND | | ±50 | mA |
| T _{stg} | Storage temperature | -65 | 150 | °C |

- (1) Operation outside the *Absolute Maximum Ratings* may cause permanent device damage. Absolute maximum ratings do not imply functional operation of the device at these or any other conditions beyond those listed under *Recommended Operating Conditions*. If briefly operating outside the *Recommended Operating Conditions* but within the *Absolute Maximum Ratings*, the device may not sustain damage, but it may not be fully functional. Operating the device in this manner may affect device reliability, functionality, performance, and shorten the device lifetime.
- (2) The input and output voltage ratings may be exceeded if the input and output current ratings are observed.

6.2 ESD Ratings

| | | VALUE | UNIT |
|--------------------|-------------------------|--|-------|
| V _(ESD) | Electrostatic discharge | Human body model (HBM), per AEC Q100-002 HBM ESD Classification Level 2 ⁽¹⁾ | ±2000 |
| | | Charged device model (CDM), per AEC Q100-011 CDM ESD Classification Level C4B | ±1000 |

- (1) AEC Q100-002 indicate that HBM stressing shall be in accordance with the ANSI/ESDA/JEDEC JS-001 specification.

6.3 Recommended Operating Conditions

over operating free-air temperature range (unless otherwise noted)

| Spec | Description | Condition | MIN | MAX | UNIT |
|-----------------|------------------------------------|------------------------------------|------|-----------------|------|
| V _{CC} | Supply voltage | | 1.6 | 5.5 | V |
| V _I | Input voltage | | 0 | 5.5 | V |
| V _O | Output voltage | | 0 | V _{CC} | V |
| V _{IH} | High-level input voltage | V _{CC} = 1.65 V to 2 V | 1.1 | | V |
| | | V _{CC} = 2.25 V to 2.75 V | 1.28 | | |
| | | V _{CC} = 3 V to 3.6 V | 1.45 | | |
| | | V _{CC} = 4.5 V to 5.5 V | 2 | | |
| V _{IL} | Low-Level input voltage | V _{CC} = 1.65 V to 2 V | | 0.5 | V |
| | | V _{CC} = 2.25 V to 2.75 V | | 0.65 | |
| | | V _{CC} = 3 V to 3.6 V | | 0.75 | |
| | | V _{CC} = 4.5 V to 5.5 V | | 0.85 | |
| I _O | Output current | V _{CC} = 1.6 V to 2 V | | ±3 | mA |
| | | V _{CC} = 2.25 V to 2.75 V | | ±7 | |
| | | V _{CC} = 3.3 V to 5.0 V | | ±15 | |
| Δt/Δv | Input transition rise or fall rate | V _{CC} = 1.6 V to 5.0 V | | 20 | ns/V |
| T _A | Operating free-air temperature | | -40 | 125 | °C |

6.4 Thermal Information

| THERMAL METRIC ⁽¹⁾ | | SN74LV6T17-Q1 | | UNIT |
|-------------------------------|--|---------------|------------|------|
| | | BQA (WQFN) | PW (TSSOP) | |
| | | 14 PINS | 14 PINS | |
| R _{θJA} | Junction-to-ambient thermal resistance | 88.3 | 151.0 | °C/W |
| R _{θJC(top)} | Junction-to-case (top) thermal resistance | 90.9 | 80.0 | °C/W |
| R _{θJB} | Junction-to-board thermal resistance | 56.8 | 94.2 | °C/W |
| Ψ _{JT} | Junction-to-top characterization parameter | 9.9 | 28.0 | °C/W |
| Y _{JB} | Junction-to-board characterization parameter | 56.7 | 93.6 | °C/W |
| R _{θJC(bot)} | Junction-to-case (bottom) thermal resistance | 33.4 | N/A | °C/W |

- (1) For more information about traditional and new thermal metrics, see the [Semiconductor and IC Package Thermal Metrics](#) application report.

6.5 Electrical Characteristics

over operating free-air temperature range (unless otherwise noted)

| PARAMETER | TEST CONDITIONS | V _{CC} | T _A = 25°C | | | -40°C to 125°C | | | UNIT |
|------------------------------------|--|------------------|-----------------------|---------------------|-------|----------------------|-----|-------|------|
| | | | MIN | TYP | MAX | MIN | TYP | MAX | |
| V _{T+} | Positive-going input threshold voltage | 1.65 V to 2 V | 0.6 | | 1.2 | 0.5 | | 1.27 | V |
| | | 2.25 V to 2.75 V | 0.73 | | 1.39 | 0.64 | | 1.44 | |
| | | 3 V to 3.6 V | 0.88 | | 1.59 | 0.80 | | 1.63 | |
| | | 4.5 V to 5.5 V | 1.15 | | 2.03 | 1.1 | | 2.07 | |
| V _{T-} | Negative-going input threshold voltage | 1.65 V to 2 V | 0.225 | | 0.685 | 0.185 | | 0.755 | V |
| | | 2.25 V to 2.75 V | 0.295 | | 0.775 | 0.265 | | 0.805 | |
| | | 3 V to 3.6 V | 0.385 | | 0.875 | 0.345 | | 0.895 | |
| | | 4.5 V to 5.5 V | 0.535 | | 1.075 | 0.495 | | 1.085 | |
| ΔV _T | Hysteresis (V _{T+} - V _{T-}) | 1.65 V to 2 V | 0.35 | | 0.68 | 0.28 | | 0.8 | V |
| | | 2.25 V to 2.75 V | 0.4 | | 0.77 | 0.33 | | 0.87 | |
| | | 3 V to 3.6 V | 0.44 | | 0.88 | 0.38 | | 0.91 | |
| | | 4.5 V to 5.5 V | 0.53 | | 1.2 | 0.51 | | 1.4 | |
| V _{OH} | I _{OH} = -50 uA | 1.65 V to 5.5 V | V _{CC} -0.1 | | | V _{CC} -0.1 | | | V |
| | I _{OH} = -2 mA | 1.65 V to 2 V | 1.28 | 1.7 ⁽¹⁾ | | 1.21 | | | |
| | I _{OH} = -3 mA | 2.25 V to 2.75 V | 2 | 2.4 ⁽¹⁾ | | 1.93 | | | |
| | I _{OH} = -5.5 mA | 3 V to 3.6 V | 2.6 | 3.08 ⁽¹⁾ | | 2.49 | | | |
| | I _{OH} = -8 mA | 4.5 V to 5.5 V | 4.1 | 4.65 ⁽¹⁾ | | 3.95 | | | |
| V _{OL} | I _{OL} = 50 uA | 1.65 V to 5.5 V | | | 0.1 | | | 0.1 | V |
| | I _{OL} = 2 mA | 1.65 V to 2 V | | 0.1 ⁽¹⁾ | 0.2 | | | 0.25 | |
| | I _{OL} = 3 mA | 2.25 V to 2.75 V | | 0.1 ⁽¹⁾ | 0.15 | | | 0.2 | |
| | I _{OL} = 5.5 mA | 3 V to 3.6 V | | 0.2 ⁽¹⁾ | 0.2 | | | 0.25 | |
| | I _{OL} = 8 mA | 4.5 V to 5.5 V | | 0.3 ⁽¹⁾ | 0.3 | | | 0.35 | |
| I _I | V _I = 0 V or V _{CC} | 0 V to 5.5 V | | | ±0.1 | | | ±1 | μA |
| I _{CC} | V _I = 0 V or V _{CC} , I _O = 0; open on loading | 1.65 V to 5.5 V | | | 2 | | | 20 | μA |
| ΔI _{CC} | One input at 0.3 V or 3.4 V, other inputs at 0 or V _{CC} , I _O = 0 | 5.5 V | | | 1.35 | | | 1.5 | mA |
| | One input at 0.3 V or 1.1 V, other inputs at 0 or V _{CC} , I _O = 0 | 1.8 V | | | 10 | | | 20 | μA |
| C _I | V _I = V _{CC} or GND | 5 V | | 4 | 10 | | | 10 | pF |
| C _O | V _O = V _{CC} or GND | 5 V | | 3 | | | | | pF |
| C _{PD} ^{(2) (3)} | No load, F = 1Mhz | 5 V | | 14 | | | | | pF |

(1) Typical value at nearest nominal voltage (1.8 V, 2.5 V, 3.3 V, and 5 V)

(2) C_{PD} is used to determine the dynamic power consumption, per channel.

(3) P_D = V_{CC}² × F_I × (C_{PD} + C_L) where F_I = input frequency, C_L = output load capacitance, V_{CC} = supply voltage.

6.6 Switching Characteristics

over operating free-air temperature range; (unless otherwise noted). See *Parameter Measurement Information*

| PARAMETER | FROM (INPUT) | TO (OUTPUT) | V _{CC} | LOAD CAPACITANCE | T _A = 25°C | | | -40°C to 125°C | | | UNIT |
|-----------------|-----------------------|-------------|-----------------|-----------------------|-----------------------|------|------|----------------|------|------|------|
| | | | | | MIN | TYP | MAX | MIN | TYP | MAX | |
| t _{PD} | A | Y | 1.8 V | C _L = 15pF | 8.85 | 14 | 19.7 | 7.45 | 15.5 | 22.8 | nS |
| | | | | C _L = 50pF | 10.8 | 17.1 | 23.3 | 9.07 | 18.4 | 26.7 | |
| | | | 2.5 V | C _L = 15pF | 6.44 | 8.9 | 11 | 5.42 | 9.6 | 13.4 | |
| | | | | C _L = 50pF | 7.94 | 10.8 | 13.2 | 6.59 | 11.7 | 16 | |
| | | | 3.3 V | C _L = 15pF | 5.24 | 6.9 | 8.4 | 4.42 | 7.5 | 10.2 | |
| | | | | C _L = 50pF | 6.58 | 8.5 | 10.1 | 5.41 | 9.1 | 12.2 | |
| 5 V | C _L = 15pF | 4.09 | 5.1 | 6.2 | 3.29 | 5.5 | 7.7 | | | | |
| | C _L = 50pF | 5.06 | 6.4 | 7.7 | 4.07 | 6.9 | 9.4 | | | | |

6.7 Noise Characteristics

V_{CC} = 5 V, C_L = 50 pF, T_A = 25°C

| PARAMETER | DESCRIPTION | MIN | TYP | MAX | UNIT |
|--------------------|---|------|------|-----|------|
| V _{OL(P)} | Quiet output, maximum dynamic V _{OL} | | 0.9 | 0.8 | V |
| V _{OL(V)} | Quiet output, minimum dynamic V _{OL} | -0.8 | -0.3 | | V |
| V _{OH(V)} | Quiet output, minimum dynamic V _{OH} | 4.4 | 5 | | V |
| V _{IH(D)} | High-level dynamic input voltage | 2.1 | | | V |
| V _{IL(D)} | Low-level dynamic input voltage | | | 0.5 | V |

7 Typical Characteristics

T_A = 25°C (unless otherwise noted)

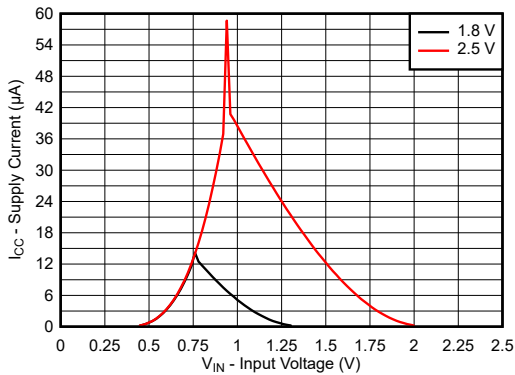

Figure 7-1. Supply Current Across Input Voltage 1.8-V and 2.5-V Supply

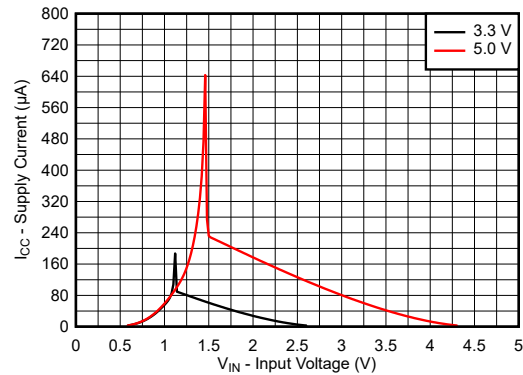

Figure 7-2. Supply Current Across Input Voltage 3.3-V and 5.0-V Supply

7 Typical Characteristics (continued)

$T_A = 25^\circ\text{C}$ (unless otherwise noted)

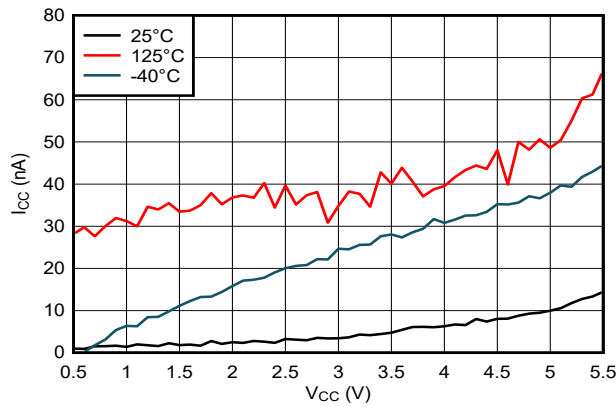

Figure 7-3. Supply Current Across Supply Voltage

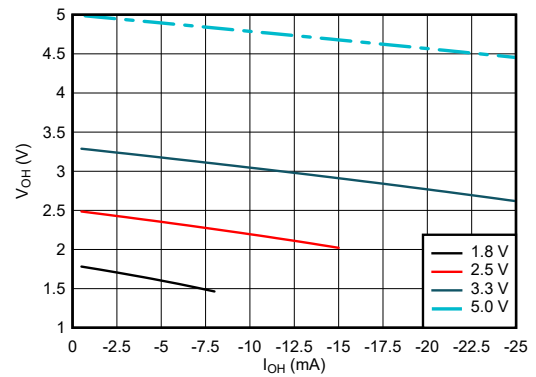

Figure 7-4. Output Voltage vs Current in HIGH State

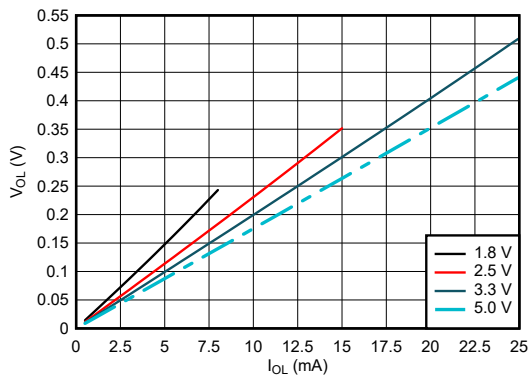

Figure 7-5. Output Voltage vs Current in LOW State

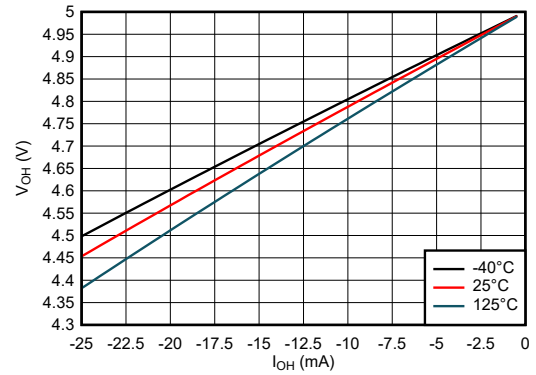

Figure 7-6. Output Voltage vs Current in HIGH State; 5-V Supply

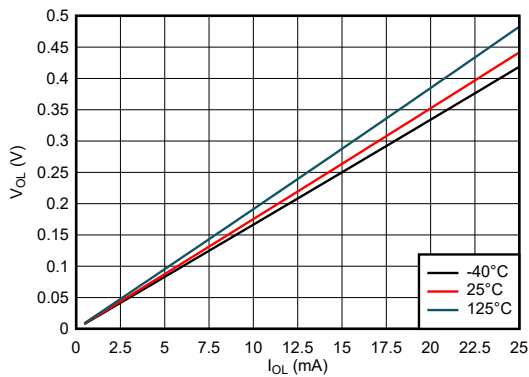

Figure 7-7. Output Voltage vs Current in LOW State; 5-V Supply

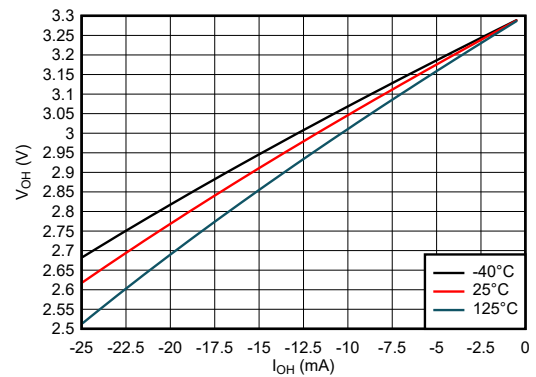

Figure 7-8. Output Voltage vs Current in HIGH State; 3.3-V Supply

7 Typical Characteristics (continued)

$T_A = 25^\circ\text{C}$ (unless otherwise noted)

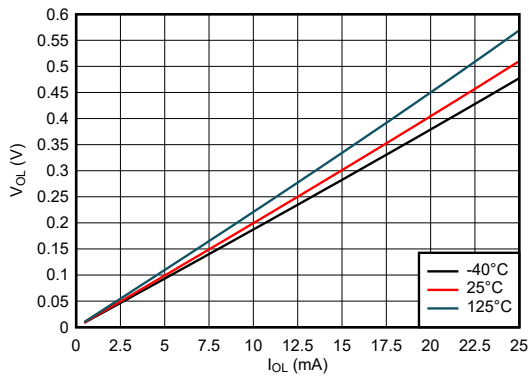

Figure 7-9. Output Voltage vs Current in LOW State; 3.3-V Supply

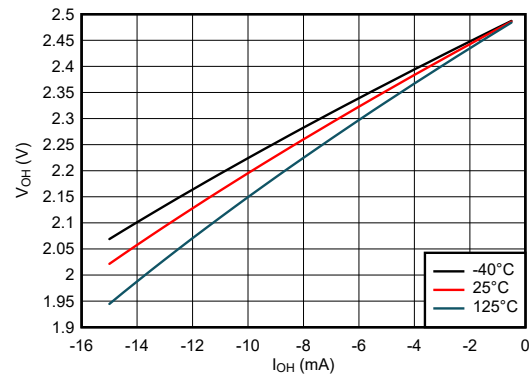

Figure 7-10. Output Voltage vs Current in HIGH State; 2.5-V Supply

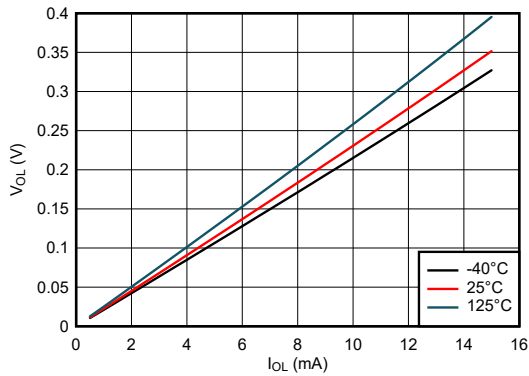

Figure 7-11. Output Voltage vs Current in LOW State; 2.5-V Supply

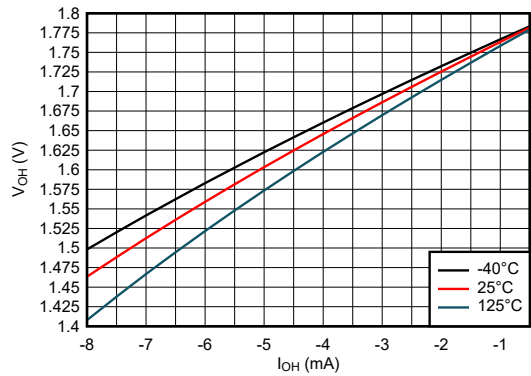

Figure 7-12. Output Voltage vs Current in HIGH State; 1.8-V Supply

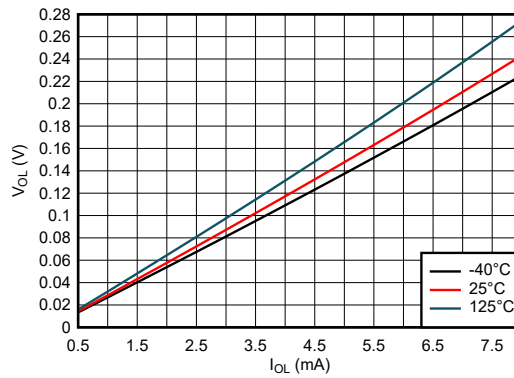

Figure 7-13. Output Voltage vs Current in LOW State; 1.8-V Supply

8 Parameter Measurement Information

Phase relationships between waveforms were chosen arbitrarily. All input pulses are supplied by generators having the following characteristics: $PRR \leq 1 \text{ MHz}$, $Z_O = 50 \Omega$.

For clock inputs, f_{max} is measured when the input duty cycle is 50%.

The outputs are measured one at a time with one input transition per measurement.



(1) C_L includes probe and test-fixture capacitance.

Figure 8-1. Load Circuit for Push-Pull Outputs



(1) The greater between t_{pLH} and t_{pHL} is the same as t_{pd} .

Figure 8-2. Voltage Waveforms Propagation Delays



(1) The greater between t_r and t_f is the same as t_t .

Figure 8-3. Voltage Waveforms, Input and Output Transition Times

9 Detailed Description

9.1 Overview

The SN74LV6T17-Q1 device contains six independent Buffers with Schmitt-trigger inputs. Each gate performs the Boolean function $Y = A$ in positive logic. The output level is referenced to the supply voltage (V_{CC}) and supports 1.8-V, 2.5-V, 3.3-V, and 5-V CMOS levels.

9.2 Functional Block Diagram

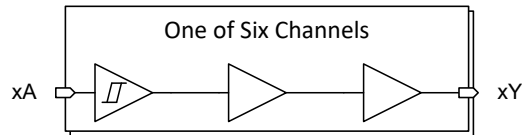

9.3 Feature Description

9.3.1 Balanced CMOS Push-Pull Outputs

This device includes balanced CMOS push-pull outputs. The term *balanced* indicates that the device can sink and source similar currents. The drive capability of this device may create fast edges into light loads, so routing and load conditions should be considered to prevent ringing. Additionally, the outputs of this device are capable of driving larger currents than the device can sustain without being damaged. It is important for the output power of the device to be limited to avoid damage due to overcurrent. The electrical and thermal limits defined in the *Absolute Maximum Ratings* must be followed at all times.

Unused push-pull CMOS outputs should be left disconnected.

9.3.2 Clamp Diode Structure

The outputs to this device have both positive and negative clamping diodes, and the inputs to this device have negative clamping diodes only as shown in [Figure 9-1](#).

CAUTION

Voltages beyond the values specified in the *Absolute Maximum Ratings* table can cause damage to the device. The input and output voltage ratings may be exceeded if the input and output clamp-current ratings are observed.

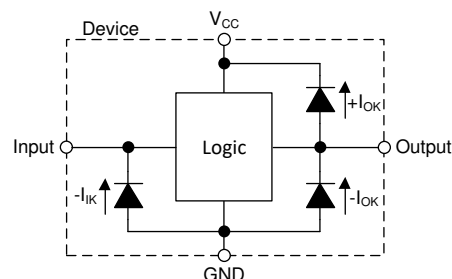

Figure 9-1. Electrical Placement of Clamping Diodes for Each Input and Output

9.3.3 CMOS Schmitt-Trigger Inputs

This device includes inputs with the Schmitt-trigger architecture. These inputs are high impedance and are typically modeled as a resistor in parallel with the input capacitance given in the *Electrical Characteristics* table from the input to ground. The worst case resistance is calculated with the maximum input voltage, given in the *Absolute Maximum Ratings* table, and the maximum input leakage current, given in the *Electrical Characteristics* table, using Ohm's law ($R = V \div I$).

The Schmitt-trigger input architecture provides hysteresis as defined by ΔV_T in the *Electrical Characteristics* table, which makes this device extremely tolerant to slow or noisy inputs. While the inputs can be driven much slower than standard CMOS inputs, it is still recommended to properly terminate unused inputs. Driving the

inputs with slow transitioning signals will increase dynamic current consumption of the device. For additional information regarding Schmitt-trigger inputs, please see [Understanding Schmitt Triggers](#).

9.3.4 LVxT Enhanced Input Voltage

The SN74LV6T17-Q1 belongs to TI's LVxT family of logic devices with integrated voltage level translation. This family of devices was designed with reduced input voltage thresholds to support up-translation, and inputs tolerant of signals with up to 5.5 V levels to support down-translation. The output voltage will always be referenced to the supply voltage (V_{CC}), as described in the *Electrical Characteristics* table. For proper functionality, input signals must remain at or below the specified $V_{IH(MIN)}$ level for a HIGH input state, and at or below the specified $V_{IL(MAX)}$ for a LOW input state. [Figure 9-2](#) shows the typical V_{IH} and V_{IL} levels for the LVxT family of devices, as well as the voltage levels for standard CMOS devices for comparison.

The inputs are high impedance and are typically modeled as a resistor in parallel with the input capacitance given in the *Electrical Characteristics*. The worst case resistance is calculated with the maximum input voltage, given in the *Absolute Maximum Ratings*, and the maximum input leakage current, given in the *Electrical Characteristics*, using Ohm's law ($R = V \div I$).

The inputs require that input signals transition between valid logic states quickly, as defined by the input transition time or rate in the *Recommended Operating Conditions* table. Failing to meet this specification will result in excessive power consumption and could cause oscillations. More details can be found in the [Implications of Slow or Floating CMOS Inputs](#) application report.

Do not leave inputs floating at any time during operation. Unused inputs must be terminated at V_{CC} or GND. If a system will not be actively driving an input at all times, then a pull-up or pull-down resistor can be added to provide a valid input voltage during these times. The resistor value will depend on multiple factors; however, a 10-k Ω resistor is recommended and will typically meet all requirements.

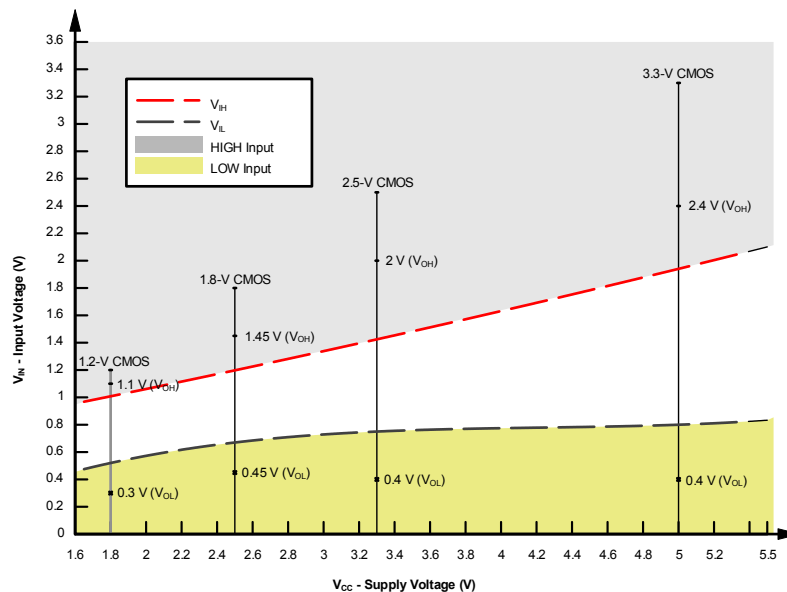

Figure 9-2. LVxT Input Voltage Levels

9.3.4.1 Down Translation

Signals can be translated down using the SN74LV6T17-Q1. The voltage applied at the V_{CC} will determine the output voltage and the input thresholds as described in the *Recommended Operating Conditions* and *Electrical Characteristics* tables.

When connected to a high-impedance input, the output voltage will be approximately V_{CC} in the HIGH state, and 0 V in the LOW state. As shown in [Figure 9-2](#), ensure that the input signals in the HIGH state are between $V_{IH(MIN)}$ and 5.5 V, and input signals in the LOW state are lower than $V_{IL(MAX)}$.

As shown in Figure 9-3 for example, the standard CMOS inputs for devices operating at 5.0 V, 3.3 V or 2.5 V can be down-translated to match 1.8 V CMOS signals when operating from 1.8-V V_{CC} .

Down Translation Combinations are as follows:

- 1.8-V V_{CC} – Inputs from 2.5 V, 3.3 V, and 5.0 V
- 2.5-V V_{CC} – Inputs from 3.3 V and 5.0 V
- 3.3-V V_{CC} – Inputs from 5.0 V

9.3.4.2 Up Translation

Input signals can be up translated using the SN74LV6T17-Q1. The voltage applied at V_{CC} will determine the output voltage and the input thresholds as described in the *Recommended Operating Conditions* and *Electrical Characteristics* tables. When connected to a high-impedance input, the output voltage will be approximately V_{CC} in the HIGH state, and 0 V in the LOW state.

The inputs have reduced thresholds that allow for input HIGH state levels which are much lower than standard values. For example, standard CMOS inputs for a device operating at a 5-V supply will have a $V_{IH(MIN)}$ of 3.5 V. For the SN74LV6T17-Q1, $V_{IH(MIN)}$ with a 5-V supply is only 2 V, which would allow for up-translation from a typical 2.5-V to 5-V signals.

As shown in Figure 9-3, ensure that the input signals in the HIGH state are above $V_{IH(MIN)}$ and input signals in the LOW state are lower than $V_{IL(MAX)}$.

Up Translation Combinations are as follows:

- 1.8-V V_{CC} – Inputs from 1.2 V
- 2.5-V V_{CC} – Inputs from 1.8 V
- 3.3-V V_{CC} – Inputs from 1.8 V and 2.5 V
- 5.0-V V_{CC} – Inputs from 2.5 V and 3.3 V

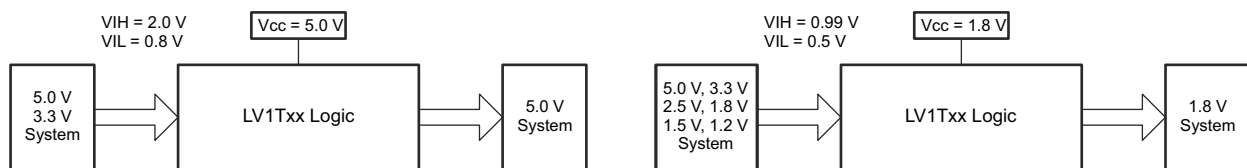

Figure 9-3. LVxT Up and Down Translation Example

9.3.5 Wettable Flanks

This device includes wettable flanks for at least one package. See the *Features* section on the front page of the data sheet for which packages include this feature.

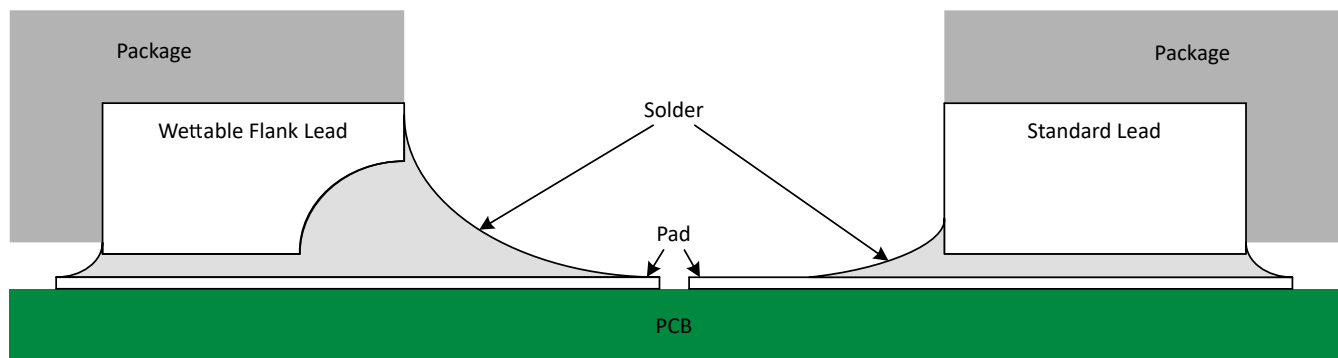

Figure 9-4. Simplified Cutaway View of Wettable-Flank QFN Package and Standard QFN Package After Soldering

Wettable flanks help improve side wetting after soldering, which makes QFN packages easier to inspect with automatic optical inspection (AOI). As shown in Figure 9-4, a wettable flank can be dimpled or step-cut to

provide additional surface area for solder adhesion which assists in reliably creating a side fillet. See the mechanical drawing for additional details.

9.4 Device Functional Modes

Table 9-1 lists the functional modes of the SN74LV6T17-Q1.

Table 9-1. Function Table

| INPUT A ⁽¹⁾ | OUTPUT Y |
|------------------------|----------|
| H | H |
| L | L |

(1) H = high voltage level, L = low voltage level, X = do not care, Z = high impedance

10 Application and Implementation

Note

Information in the following applications sections is not part of the TI component specification, and TI does not warrant its accuracy or completeness. TI's customers are responsible for determining suitability of components for their purposes, as well as validating and testing their design implementation to confirm system functionality.

10.1 Application Information

The SN74LV6T17-Q1 can be used to drive signals over relatively long traces or transmission lines. In order to reduce ringing caused by impedance mismatches between the driver, transmission line, and receiver, a series damping resistor placed in series with the transmitter's output can be used. The figure in the *Application Curve* section shows the received signal with three separate resistor values. Just a small amount of resistance can make a significant impact on signal integrity in this type of application.

10.2 Typical Application

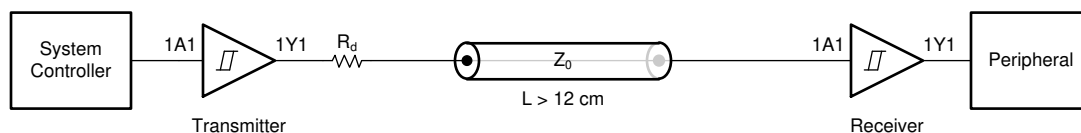

Figure 10-1. Typical Application Block Diagram

10.2.1 Design Requirements

10.2.1.1 Power Considerations

Ensure the desired supply voltage is within the range specified in the *Recommended Operating Conditions*. The supply voltage sets the electrical characteristics of the device as described in the *Electrical Characteristics* section.

The positive voltage supply must be capable of sourcing current equal to the total current to be sourced by all outputs of the SN74LV6T17-Q1 plus the maximum static supply current, I_{CC} , listed in the *Electrical Characteristics*, and any transient current required for switching. The logic device can only source as much current that is provided by the positive supply source. Be sure to not exceed the maximum total current through V_{CC} listed in the *Absolute Maximum Ratings*.

The ground must be capable of sinking current equal to the total current to be sunk by all outputs of the SN74LV6T17-Q1 plus the maximum supply current, I_{CC} , listed in the *Electrical Characteristics*, and any transient current required for switching. The logic device can only sink as much current that can be sunk into its ground connection. Be sure to not exceed the maximum total current through GND listed in the *Absolute Maximum Ratings*.

The SN74LV6T17-Q1 can drive a load with a total capacitance less than or equal to 50 pF while still meeting all of the data sheet specifications. Larger capacitive loads can be applied; however, it is not recommended to exceed 50 pF.

The SN74LV6T17-Q1 can drive a load with total resistance described by $R_L \geq V_O / I_O$, with the output voltage and current defined in the *Electrical Characteristics* table with V_{OH} and V_{OL} . When outputting in the HIGH state, the output voltage in the equation is defined as the difference between the measured output voltage and the supply voltage at the V_{CC} pin.

Total power consumption can be calculated using the information provided in the [CMOS Power Consumption and Cpd Calculation](#) application note.

Thermal increase can be calculated using the information provided in the [Thermal Characteristics of Standard Linear and Logic \(SLL\) Packages and Devices](#) application note.

CAUTION

The maximum junction temperature, $T_{J(max)}$ listed in the *Absolute Maximum Ratings*, is an additional limitation to prevent damage to the device. Do not violate any values listed in the *Absolute Maximum Ratings*. These limits are provided to prevent damage to the device.

10.2.1.2 Input Considerations

Input signals must cross $V_{t-(min)}$ to be considered a logic LOW, and $V_{t+(max)}$ to be considered a logic HIGH. Do not exceed the maximum input voltage range found in the *Absolute Maximum Ratings*.

Unused inputs must be terminated to either V_{CC} or ground. The unused inputs can be directly terminated if the input is completely unused, or they can be connected with a pull-up or pull-down resistor if the input will be used sometimes, but not always. A pull-up resistor is used for a default state of HIGH, and a pull-down resistor is used for a default state of LOW. The drive current of the controller, leakage current into the SN74LV6T17-Q1 (as specified in the *Electrical Characteristics*), and the desired input transition rate limits the resistor size. A 10-k Ω resistor value is often used due to these factors.

The SN74LV6T17-Q1 has no input signal transition rate requirements because it has Schmitt-trigger inputs.

Another benefit to having Schmitt-trigger inputs is the ability to reject noise. Noise with a large enough amplitude can still cause issues. To know how much noise is too much, please refer to the $\Delta V_{T(min)}$ in the *Electrical Characteristics*. This hysteresis value will provide the peak-to-peak limit.

Unlike what happens with standard CMOS inputs, Schmitt-trigger inputs can be held at any valid value without causing huge increases in power consumption. The typical additional current caused by holding an input at a value other than V_{CC} or ground is plotted in the *Typical Characteristics*.

Refer to the *Feature Description* section for additional information regarding the inputs for this device.

10.2.1.3 Output Considerations

The positive supply voltage is used to produce the output HIGH voltage. Drawing current from the output will decrease the output voltage as specified by the V_{OH} specification in the *Electrical Characteristics*. The ground voltage is used to produce the output LOW voltage. Sinking current into the output will increase the output voltage as specified by the V_{OL} specification in the *Electrical Characteristics*.

Push-pull outputs that could be in opposite states, even for a very short time period, should never be connected directly together. This can cause excessive current and damage to the device.

Two channels within the same device with the same input signals can be connected in parallel for additional output drive strength.

Unused outputs can be left floating. Do not connect outputs directly to V_{CC} or ground.

Refer to the *Feature Description* section for additional information regarding the outputs for this device.

10.2.2 Detailed Design Procedure

1. Add a decoupling capacitor from V_{CC} to GND. The capacitor needs to be placed physically close to the device and electrically close to both the V_{CC} and GND pins. An example layout is shown in the *Layout* section.
2. Ensure the capacitive load at the output is ≤ 50 pF. This is not a hard limit; it will, however, ensure optimal performance. This can be accomplished by providing short, appropriately sized traces from the SN74LV6T17-Q1 to one or more of the receiving devices.
3. Ensure the resistive load at the output is larger than $(V_{CC} / I_{O(max)}) \Omega$. This will ensure that the maximum output current from the *Absolute Maximum Ratings* is not violated. Most CMOS inputs have a resistive load measured in $M\Omega$; much larger than the minimum calculated previously.
4. Thermal issues are rarely a concern for logic gates; the power consumption and thermal increase, however, can be calculated using the steps provided in the application report, [CMOS Power Consumption and Cpd Calculation](#).

10.2.3 Application Curves

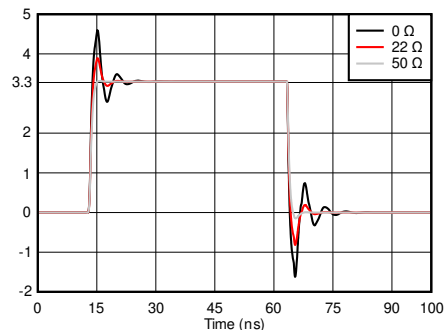

Figure 10-2. Simulated Signal Integrity at the Receiver With Different Damping Resistor (R_d) Values

11 Layout

11.1 Layout Guidelines

When using multiple-input and multiple-channel logic devices, inputs must never be left floating. In many cases, functions or parts of functions of digital logic devices are unused (for example, when only two inputs of a triple-input AND gate are used or only 3 of the 4 buffer gates are used). Such unused input pins must not be left unconnected because the undefined voltages at the outside connections result in undefined operational states. All unused inputs of digital logic devices must be connected to a logic high or logic low voltage, as defined by the input voltage specifications, to prevent them from floating. The logic level that must be applied to any particular unused input depends on the function of the device. Generally, the inputs are tied to GND or V_{CC} , whichever makes more sense for the logic function or is more convenient.

11.2 Layout Example

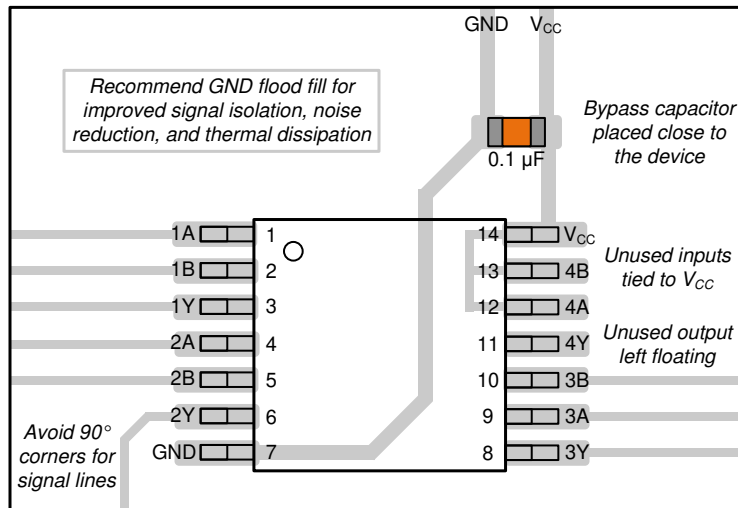

Figure 11-1. Example Layout for the SN74LV6T17-Q1

12 Device and Documentation Support

TI offers an extensive line of development tools. Tools and software to evaluate the performance of the device, generate code, and develop solutions are listed below.

12.1 Documentation Support

12.1.1 Related Documentation

For related documentation, see the following:

- Texas Instruments, [CMOS Power Consumption and Cpd Calculation application note](#)
- Texas Instruments, [Designing With Logic application note](#)
- Texas Instruments, [Thermal Characteristics of Standard Linear and Logic \(SLL\) Packages and Devices application note](#)
- Texas Instruments, [Implications of Slow or Floating CMOS Inputs application note](#)

12.2 Receiving Notification of Documentation Updates

To receive notification of documentation updates, navigate to the device product folder on [ti.com](https://www.ti.com). Click on *Subscribe to updates* to register and receive a weekly digest of any product information that has changed. For change details, review the revision history included in any revised document.

12.3 Support Resources

TI E2E™ [support forums](#) are an engineer's go-to source for fast, verified answers and design help — straight from the experts. Search existing answers or ask your own question to get the quick design help you need.

Linked content is provided "AS IS" by the respective contributors. They do not constitute TI specifications and do not necessarily reflect TI's views; see TI's [Terms of Use](#).

12.4 Trademarks

TI E2E™ is a trademark of Texas Instruments.

All trademarks are the property of their respective owners.

12.5 Electrostatic Discharge Caution



This integrated circuit can be damaged by ESD. Texas Instruments recommends that all integrated circuits be handled with appropriate precautions. Failure to observe proper handling and installation procedures can cause damage.

ESD damage can range from subtle performance degradation to complete device failure. Precision integrated circuits may be more susceptible to damage because very small parametric changes could cause the device not to meet its published specifications.

12.6 Glossary

[TI Glossary](#) This glossary lists and explains terms, acronyms, and definitions.

13 Mechanical, Packaging, and Orderable Information

The following pages include mechanical, packaging, and orderable information. This information is the most current data available for the designated devices. This data is subject to change without notice and revision of this document. For browser-based versions of this data sheet, refer to the left-hand navigation.

PACKAGING INFORMATION

| Orderable Device | Status (1) | Package Type | Package Drawing | Pins | Package Qty | Eco Plan (2) | Lead finish/ Ball material (6) | MSL Peak Temp (3) | Op Temp (°C) | Device Marking (4/5) | Samples |
|--------------------|---------------|--------------|-----------------|------|-------------|-----------------|--------------------------------------|----------------------|--------------|-------------------------|-------------------------|
| SN74LV6T17QPWRQ1 | ACTIVE | TSSOP | PW | 14 | 3000 | RoHS & Green | NIPDAU | Level-1-260C-UNLIM | -40 to 85 | LVT17Q | Samples |
| SN74LV6T17QWBQARQ1 | ACTIVE | WQFN | BQA | 14 | 3000 | RoHS & Green | NIPDAU | Level-1-260C-UNLIM | -40 to 85 | LVT17Q | Samples |

(1) The marketing status values are defined as follows:

ACTIVE: Product device recommended for new designs.

LIFEBUY: TI has announced that the device will be discontinued, and a lifetime-buy period is in effect.

NRND: Not recommended for new designs. Device is in production to support existing customers, but TI does not recommend using this part in a new design.

PREVIEW: Device has been announced but is not in production. Samples may or may not be available.

OBSOLETE: TI has discontinued the production of the device.

(2) **RoHS:** TI defines "RoHS" to mean semiconductor products that are compliant with the current EU RoHS requirements for all 10 RoHS substances, including the requirement that RoHS substance do not exceed 0.1% by weight in homogeneous materials. Where designed to be soldered at high temperatures, "RoHS" products are suitable for use in specified lead-free processes. TI may reference these types of products as "Pb-Free".

RoHS Exempt: TI defines "RoHS Exempt" to mean products that contain lead but are compliant with EU RoHS pursuant to a specific EU RoHS exemption.

Green: TI defines "Green" to mean the content of Chlorine (Cl) and Bromine (Br) based flame retardants meet JS709B low halogen requirements of <=1000ppm threshold. Antimony trioxide based flame retardants must also meet the <=1000ppm threshold requirement.

(3) MSL, Peak Temp. - The Moisture Sensitivity Level rating according to the JEDEC industry standard classifications, and peak solder temperature.

(4) There may be additional marking, which relates to the logo, the lot trace code information, or the environmental category on the device.

(5) Multiple Device Markings will be inside parentheses. Only one Device Marking contained in parentheses and separated by a "~" will appear on a device. If a line is indented then it is a continuation of the previous line and the two combined represent the entire Device Marking for that device.

(6) Lead finish/Ball material - Orderable Devices may have multiple material finish options. Finish options are separated by a vertical ruled line. Lead finish/Ball material values may wrap to two lines if the finish value exceeds the maximum column width.

Important Information and Disclaimer:The information provided on this page represents TI's knowledge and belief as of the date that it is provided. TI bases its knowledge and belief on information provided by third parties, and makes no representation or warranty as to the accuracy of such information. Efforts are underway to better integrate information from third parties. TI has taken and continues to take reasonable steps to provide representative and accurate information but may not have conducted destructive testing or chemical analysis on incoming materials and chemicals. TI and TI suppliers consider certain information to be proprietary, and thus CAS numbers and other limited information may not be available for release.

In no event shall TI's liability arising out of such information exceed the total purchase price of the TI part(s) at issue in this document sold by TI to Customer on an annual basis.

OTHER QUALIFIED VERSIONS OF SN74LV6T17-Q1 :

- Catalog : [SN74LV6T17](#)

NOTE: Qualified Version Definitions:

- Catalog - TI's standard catalog product

PW (R-PDSO-G14)

PLASTIC SMALL OUTLINE



4040064-3/G 02/11

- NOTES:
- A. All linear dimensions are in millimeters. Dimensioning and tolerancing per ASME Y14.5M-1994.
 - B. This drawing is subject to change without notice.
 - C. Body length does not include mold flash, protrusions, or gate burrs. Mold flash, protrusions, or gate burrs shall not exceed 0,15 each side.
 - D. Body width does not include interlead flash. Interlead flash shall not exceed 0,25 each side.
 - E. Falls within JEDEC MO-153

GENERIC PACKAGE VIEW

BQA 14

WQFN - 0.8 mm max height

2.5 x 3, 0.5 mm pitch

PLASTIC QUAD FLATPACK - NO LEAD

This image is a representation of the package family, actual package may vary.
Refer to the product data sheet for package details.



4227145/A

BQA0014B

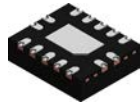

PACKAGE OUTLINE

WQFN - 0.8 mm max height

PLASTIC QUAD FLATPACK - NO LEAD

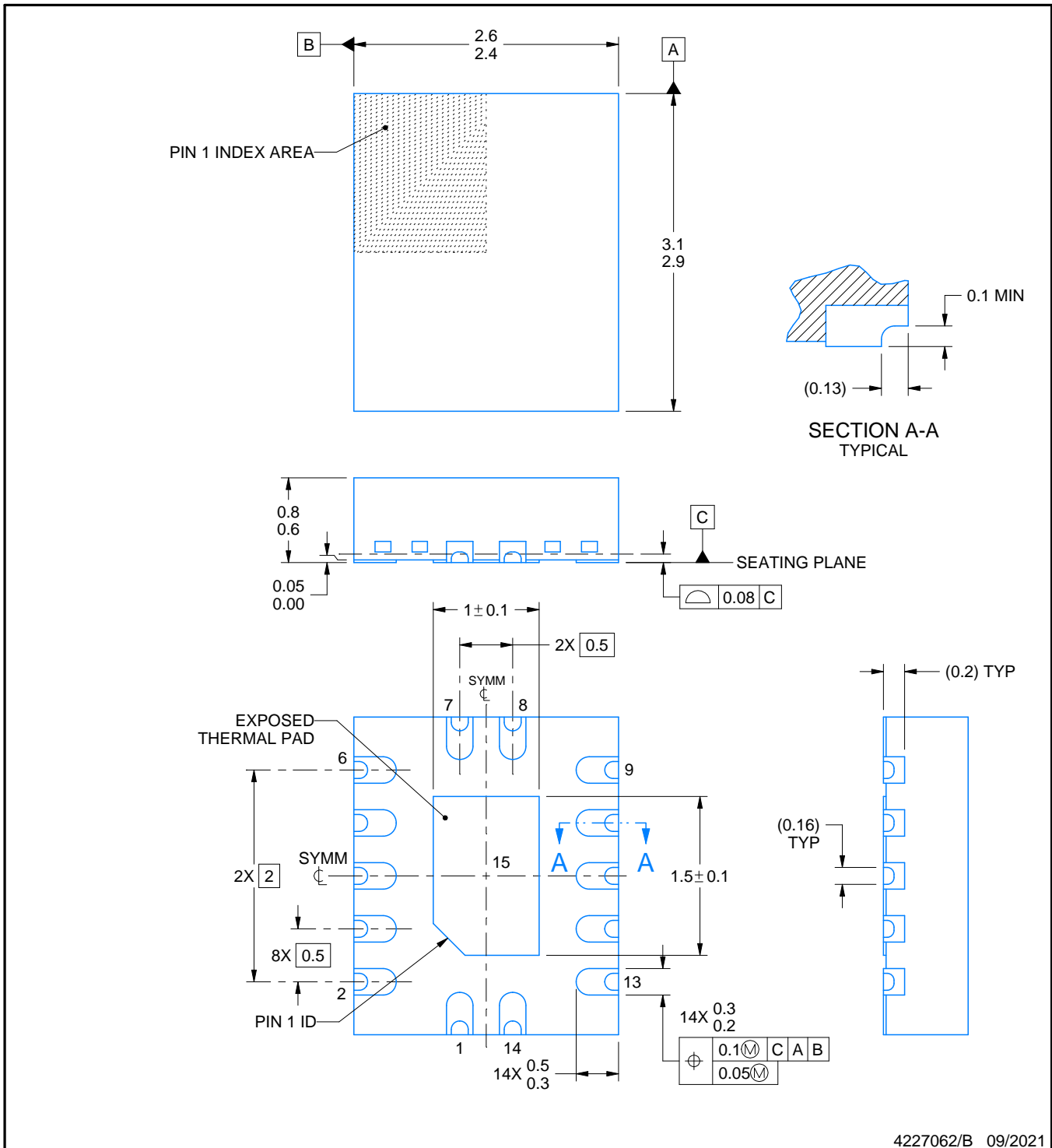

NOTES:

1. All linear dimensions are in millimeters. Any dimensions in parenthesis are for reference only. Dimensioning and tolerancing per ASME Y14.5M.
2. This drawing is subject to change without notice.
3. The package thermal pad must be soldered to the printed circuit board for thermal and mechanical performance.

EXAMPLE BOARD LAYOUT

BQA0014B

WQFN - 0.8 mm max height

PLASTIC QUAD FLATPACK - NO LEAD

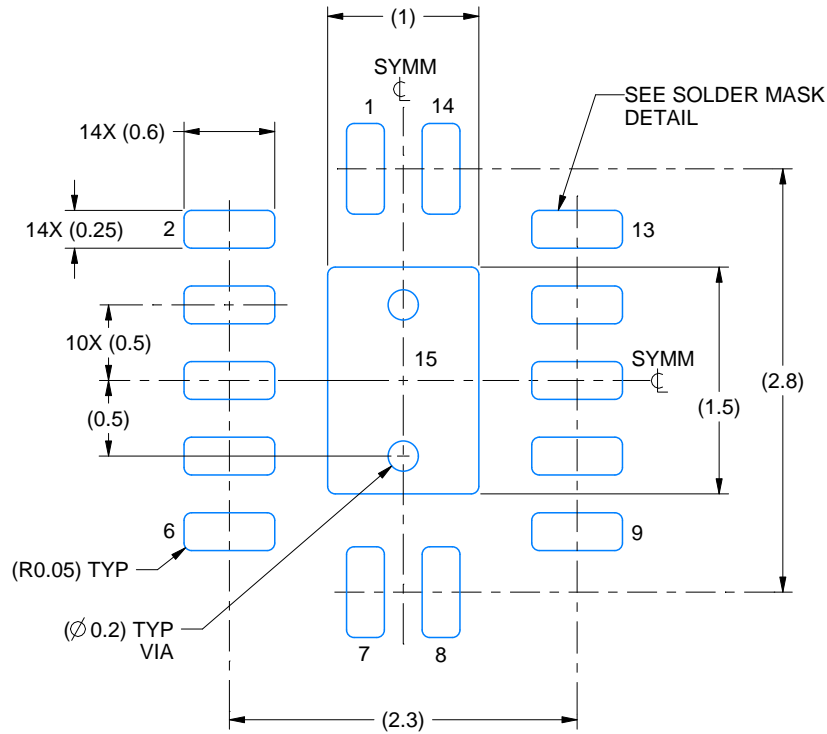

LAND PATTERN EXAMPLE
EXPOSED METAL SHOWN
SCALE: 20X

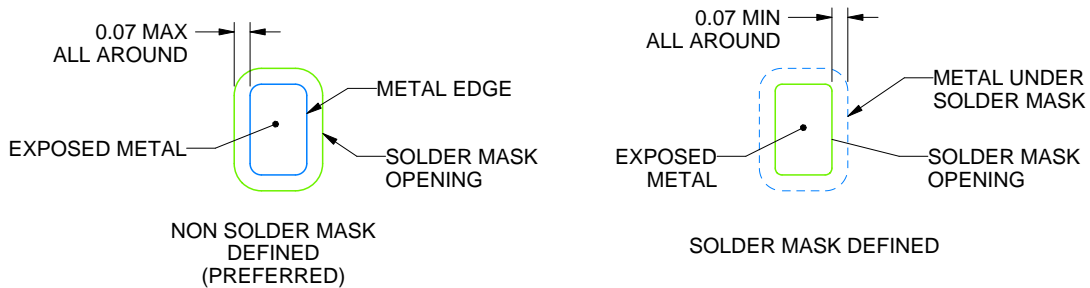

SOLDER MASK DETAILS

4227062/B 09/2021

NOTES: (continued)

4. This package is designed to be soldered to a thermal pad on the board. For more information, see Texas Instruments literature number SLUA271 (www.ti.com/lit/sluea271).
5. Vias are optional depending on application, refer to device data sheet. If any vias are implemented, refer to their locations shown on this view. It is recommended that vias under paste be filled, plugged or tented.

EXAMPLE STENCIL DESIGN

BQA0014B

WQFN - 0.8 mm max height

PLASTIC QUAD FLATPACK - NO LEAD



SOLDER PASTE EXAMPLE
BASED ON 0.125 MM THICK STENCIL
SCALE: 20X

EXPOSED PAD 15
87% PRINTED SOLDER COVERAGE BY AREA UNDER PACKAGE

4227062/B 09/2021

NOTES: (continued)

6. Laser cutting apertures with trapezoidal walls and rounded corners may offer better paste release. IPC-7525 may have alternate design recommendations.

IMPORTANT NOTICE AND DISCLAIMER

TI PROVIDES TECHNICAL AND RELIABILITY DATA (INCLUDING DATA SHEETS), DESIGN RESOURCES (INCLUDING REFERENCE DESIGNS), APPLICATION OR OTHER DESIGN ADVICE, WEB TOOLS, SAFETY INFORMATION, AND OTHER RESOURCES "AS IS" AND WITH ALL FAULTS, AND DISCLAIMS ALL WARRANTIES, EXPRESS AND IMPLIED, INCLUDING WITHOUT LIMITATION ANY IMPLIED WARRANTIES OF MERCHANTABILITY, FITNESS FOR A PARTICULAR PURPOSE OR NON-INFRINGEMENT OF THIRD PARTY INTELLECTUAL PROPERTY RIGHTS.

These resources are intended for skilled developers designing with TI products. You are solely responsible for (1) selecting the appropriate TI products for your application, (2) designing, validating and testing your application, and (3) ensuring your application meets applicable standards, and any other safety, security, regulatory or other requirements.

These resources are subject to change without notice. TI grants you permission to use these resources only for development of an application that uses the TI products described in the resource. Other reproduction and display of these resources is prohibited. No license is granted to any other TI intellectual property right or to any third party intellectual property right. TI disclaims responsibility for, and you will fully indemnify TI and its representatives against, any claims, damages, costs, losses, and liabilities arising out of your use of these resources.

TI's products are provided subject to [TI's Terms of Sale](#) or other applicable terms available either on [ti.com](https://www.ti.com) or provided in conjunction with such TI products. TI's provision of these resources does not expand or otherwise alter TI's applicable warranties or warranty disclaimers for TI products.

TI objects to and rejects any additional or different terms you may have proposed.

Mailing Address: Texas Instruments, Post Office Box 655303, Dallas, Texas 75265
Copyright © 2023, Texas Instruments Incorporated