

SNx4LVC14A Hex Schmitt-Trigger Inverters

1 Features

- Latch-up performance exceeds 100 mA per JESD 78, Class II
- ESD protection exceeds JESD 22
 - 2000-V human-body model (A114-A)
 - 200-V machine model (A115-A)
 - 1000-V charged-device model (C101)
- Operate from 1.65 V to 3.6 V V_{CC}
- Specified from -40°C to $+85^{\circ}\text{C}$, -40°C to 125°C , and -55°C to 125°C
- Inputs accept voltages to 5.5 V
- Max t_{pd} of 6.4 ns at 3.3 V
- Typical V_{OLP} (output ground bounce) <0.8 V at $V_{CC} = 3.3$ V, $T_A = 25^{\circ}\text{C}$
- Typical V_{OHV} (output V_{OH} undershoot) >2 V at $V_{CC} = 3.3$ V, $T_A = 25^{\circ}\text{C}$
- On products compliant to MIL-PRF-38535, all parameters are tested unless otherwise noted. On all other products, production processing does not necessarily include testing of all parameters.

2 Applications

- [Barcode scanner](#)
- [Cable solutions](#)
- [E-books](#)
- [Embedded PCs](#)
- [Field transmitter: temperature or pressure sensors](#)
- [Fingerprint biometrics](#)
- [HVAC: heating, ventilating, and air conditioning](#)
- [Network attached storage \(NAS\)](#)
- [Server motherboard and PSU](#)
- [Software defined radio \(SDR\)](#)
- [TV: High-definition \(HDTV\), LCD, and digital](#)
- [Video communications systems](#)
- [Wireless data access cards, headsets, keyboards, mice, and LAN cards](#)

3 Description

The SN54LVC14A hex Schmitt-trigger inverter is designed for 2.7-V to 3.6-V V_{CC} operation, and the SN74LVC14A hex Schmitt-trigger inverter is designed for 1.65-V to 3.6-V V_{CC} operation.

The devices contain six independent inverters and perform the Boolean function $Y = \bar{A}$.

Inputs can be driven from either 3.3-V or 5-V devices. This feature allows the use of these devices as translators in a mixed 3.3-V or 5-V system environment.

Device Information⁽¹⁾

PART NUMBER	PACKAGE	BODY SIZE (NOM)
SN54LVC14AFK	LCCC (20)	8.90 mm × 8.90 mm
SN54LVC14AJ	CDIP (14)	20.00 mm × 7.00 mm
SN54LVC14AW	CFP (14)	9.21 mm × 6.30 mm
SN74LVC14ANS	SO (14)	10.20 mm × 5.30 mm
SN74LVC14AD	SOIC (14)	8.65 mm × 6.00 mm
SN74LVC14ADB	SSOP (14)	6.20 mm × 5.30 mm
SN74LVC14APW	TSSOP (14)	5.00 mm × 4.40 mm
SN74LVC14ADGV	TVSOP (14)	4.40 mm × 3.60 mm
SN74LVC14ARGY	VQFN (14)	3.50 mm × 3.50 mm

- (1) For all available packages, see the orderable addendum at the end of the data sheet.



Logic Diagram (Positive Logic)



Table of Contents

1 Features	1	8.1 Overview.....	11
2 Applications	1	8.2 Functional Block Diagram.....	11
3 Description	1	8.3 Feature Description.....	11
4 Revision History	2	8.4 Device Functional Modes.....	12
5 Pin Configuration and Functions	4	9 Application and Implementation	13
6 Specifications	5	9.1 Application Information.....	13
6.1 Absolute Maximum Ratings.....	5	9.2 Typical Application.....	13
6.2 ESD Ratings.....	5	10 Power Supply Recommendations	14
6.3 Recommended Operating Conditions:		11 Layout	15
SN54LVC14A.....	5	11.1 Layout Guidelines.....	15
6.4 Recommended Operating Conditions:		11.2 Layout Examples.....	15
SN74LVC14A.....	6	12 Device and Documentation Support	16
6.5 Thermal Information.....	6	12.1 Documentation Support.....	16
6.6 Electrical Characteristics, SN54LVC14A.....	6	12.2 Receiving Notification of Documentation Updates..	16
6.7 Electrical Characteristics, SN74LVC14A.....	7	12.3 Support Resources.....	16
6.8 Switching Characteristics, SN54LVC14A.....	8	12.4 Trademarks.....	16
6.9 Switching Characteristics, SN74LVC14A.....	9	12.5 Electrostatic Discharge Caution.....	16
6.10 Operating Characteristics.....	9	12.6 Glossary.....	16
6.11 Typical Characteristics.....	9	13 Mechanical, Packaging, and Orderable Information	16
7 Parameter Measurement Information	10		
8 Detailed Description	11		

4 Revision History

NOTE: Page numbers for previous revisions may differ from page numbers in the current version.

Changes from Revision AB (June 2015) to Revision AC (April 2022)	Page
• Updated the numbering format for tables, figures, and cross-references throughout the document.....	1
• Removed the <i>Standard CMOS Inputs</i> section.....	11
• Added the <i>CMOS Schmitt-Trigger Inputs</i> section.....	11
• Removed $\Delta t/\Delta v$ specifications throughout the data sheet.....	14
Changes from Revision AA (June 2015) to Revision AB (January 2019)	Page
• Changed order of the 'Features' list	1
• Deleted "I _{off} Support Live Insertion, Partial-Power-Down Mode and Back Drive protection" from Features list.	1
• Deleted <i>Device Options</i> table, see <i>Mechanical, Packaging, and Orderable Information</i> at the end of the data sheet.....	1
• Added $V_O > V_{CC}$ to Output clamp current in <i>Absolute Maximum Ratings</i>	5
• Changed MAX value for Output clamp current, I _{OK} from: –50 to: ±50	5
• Changed values in the <i>Thermal Information</i> table to align with JEDEC standards.....	6
• Added <i>Feature Description</i> sections for <i>Balanced High-Drive CMOS Push-Pull Outputs</i> , <i>Standard CMOS Inputs</i> , <i>Clamp Diodes</i> , and <i>Over-Voltage Tolerant Inputs</i>	11
• Added <i>Related Documentation</i> and <i>Receiving Notification of Documentation Updates</i> sections.....	16
Changes from Revision Z (January 2014) to Revision AA (June 2015)	Page
• Added <i>Applications</i> , <i>Device Information</i> table, <i>Pin Configuration and Functions</i> section, <i>ESD Ratings</i> table, <i>Feature Description</i> section, <i>Device Functional Modes</i> , <i>Application and Implementation</i> section, <i>Power Supply Recommendations</i> section, <i>Layout</i> section, <i>Device and Documentation Support</i> section, and <i>Mechanical, Packaging, and Orderable Information</i> section	1
• Moved T _{stg} to <i>Absolute Maximum Ratings</i> table.....	5
Changes from Revision Y (October 2010) to Revision Z (January 2014)	Page
• Updated document to new TI data sheet format.....	1
• Updated <i>Features</i>	1

- Added Military Disclaimer to *Features* list..... 1

5 Pin Configuration and Functions

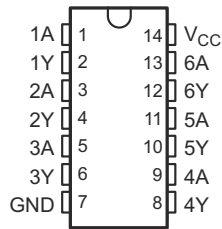

Figure 5-1. D, DB, DGV, NS, J, W, or PW Package, 14-Pin SOIC, SSOP, TVSOP, SO, CDIP, CFP, or TSSOP (Top View)

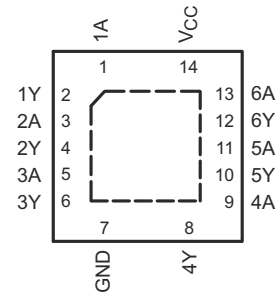

Figure 5-2. RGY Package, 14-Pin VQFN (Top View)

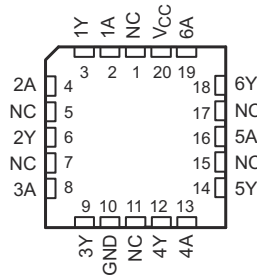

Figure 5-3. FK Package, 20-Pin LCCC (Top View)

Table 5-1. Pin Functions

PIN			TYPE ⁽¹⁾	DESCRIPTION
NAME	SOIC, SSOP, TVSOP, SO, CDIP, CFP, TSSOP, VQFN	LCCC		
1A	1	2	I	Data input
2A	3	4	I	Data input
3A	5	8	I	Data input
4A	9	13	I	Data input
5A	11	16	I	Data input
6A	13	19	I	Data input
GND	7	10	—	Ground
V _{CC}	14	20	—	Positive supply
1Y	2	3	O	Data output
2Y	4	6	O	Data output
3Y	6	9	O	Data output
4Y	8	12	O	Data output
5Y	10	14	O	Data output
6Y	12	18	O	Data output
NC	—	1	—	No connection
		5		
		7		
		11		
		15		
		17		

(1) I = input, O = output

6 Specifications

6.1 Absolute Maximum Ratings

over operating free-air temperature range (unless otherwise noted)⁽¹⁾

		MIN	MAX	UNIT	
V _{CC}	Supply voltage	-0.5	6.5	V	
V _I	Input voltage ⁽²⁾	-0.5	6.5	V	
V _O	Output voltage ^{(2) (3)}	-0.5	V _{CC} + 0.5	V	
I _{IK}	Input clamp current	V _I < 0		-50	mA
I _{OK}	Output clamp current	V _O < 0 or V _O > V _{CC}		±50	mA
I _O	Continuous output current			±50	mA
Continuous current through V _{CC} or GND				±100	mA
P _{tot}	Power dissipation	T _A = -40°C to +125°C ^{(4) (5)}		500	mW
T _{stg}	Storage temperature	-65	150	°C	

- (1) Stresses beyond those listed under *Absolute Maximum Ratings* may cause permanent damage to the device. These are stress ratings only, and functional operation of the device at these or any other conditions beyond those indicated under *Recommended Operating Conditions* is not implied. Exposure to absolute-maximum-rated conditions for extended periods may affect device reliability.
- (2) The input and output negative-voltage ratings may be exceeded if the input and output current ratings are observed.
- (3) The value of V_{CC} is provided in the *Recommended Operating Conditions* table.
- (4) For the D package: above 70°C, the value of P_{tot} derates linearly with 8 mW/K.
- (5) For the DB, DGV, NS, and PW packages: above 60°C, the value of P_{tot} derates linearly with 5.5 mW/K.

6.2 ESD Ratings

		VALUE	UNIT
V _(ESD)	Electrostatic discharge	Human body model (HBM), per ANSI/ESDA/JEDEC JS-001 ⁽¹⁾	+2000
		Charged-device model (CDM), per JEDEC specification JESD22-C101 ⁽²⁾	+1000
		Machine Model	200

- (1) JEDEC document JEP155 states that 500-V HBM allows safe manufacturing with a standard ESD control process.
- (2) JEDEC document JEP157 states that 250-V CDM allows safe manufacturing with a standard ESD control process.

6.3 Recommended Operating Conditions: SN54LVC14A

See ⁽¹⁾

		SN54LVC14A		UNIT	
		-55 TO +125°C			
		MIN	MAX		
V _{CC}	Supply voltage	Operating	2	3.6	V
		Data retention only	1.5		
V _I	Input voltage	0	5.5	V	
V _O	Output voltage	0	V _{CC}	V	
I _{OH}	High-level output current	V _{CC} = 2.7 V		-12	mA
		V _{CC} = 3 V		-24	
I _{OL}	Low-level output current	V _{CC} = 2.7 V		12	mA
		V _{CC} = 3 V		24	

- (1) All unused inputs of the device must be held at V_{CC} or GND to ensure proper device operation. See [Implications of Slow or Floating CMOS Inputs](#), SCBA004.

6.4 Recommended Operating Conditions: SN74LVC14A

See (1)

		SN74LVC14A						UNIT		
		T _A = 25°C		–40 TO +85°C		–40 TO +125°C				
		MIN	MAX	MIN	MAX	MIN	MAX			
V _{CC}	Supply voltage	Operating		1.65	3.6	1.65	3.6	1.65	3.6	V
		Data retention only		1.5		1.5		1.5		
V _I	Input voltage	0	5.5	0	5.5	0	5.5	0	5.5	V
V _O	Output voltage	0	V _{CC}	0	V _{CC}	0	V _{CC}	0	V _{CC}	V
I _{OH}	High-level output current	V _{CC} = 1.65 V			–4		–4		–4	mA
		V _{CC} = 2.3 V			–8		–8		–8	
		V _{CC} = 2.7 V			–12		–12		–12	
		V _{CC} = 3 V			–24		–24		–24	
I _{OL}	Low-level output current	V _{CC} = 1.65 V			4		4		4	mA
		V _{CC} = 2.3 V			8		8		8	
		V _{CC} = 2.7 V			12		12		12	
		V _{CC} = 3 V			24		24		24	

(1) All unused inputs of the device must be held at V_{CC} or GND to ensure proper device operation. See [Implications of Slow or Floating CMOS Inputs](#), SCBA004.

6.5 Thermal Information

THERMAL METRIC ⁽¹⁾		SN74LVC14A						UNIT
		D (SOIC)	DB (SSOP)	DGV (TVSOP)	NS (SO)	PW (TSSOP)	RGY (LCCC)	
		14 PINS				20 PINS		
R _{θJA}	Junction-to-ambient thermal resistance	117.6	131.8	153.5	115.7	145.9	93.8	°C/W
R _{θJC(top)}	Junction-to-case (top) thermal resistance	78.2	83.9	75.2	72.2	73.4	106.7	°C/W
R _{θJB}	Junction-to-board thermal resistance	71.9	79.2	86.6	74.4	87.7	69.8	°C/W
ψ _{JT}	Junction-to-top characterization parameter	39.3	41.7	19.9	33.7	18.9	22.0	°C/W
ψ _{JB}	Junction-to-board characterization parameter	71.6	78.6	85.9	74.1	87.1	70.0	°C/W
R _{θJC(bot)}	Junction-to-case (bottom) thermal resistance	—	—	—	—	—	49.4	°C/W

(1) For more information about traditional and new thermal metrics, see the [Semiconductor and IC Package Thermal Metrics](#) application report.

6.6 Electrical Characteristics, SN54LVC14A

over operating free-air temperature range (unless otherwise noted)

PARAMETER		TEST CONDITIONS		V _{CC}	SN54LVC14A			UNIT
					–55 TO +125°C			
					MIN	TYP	MAX	
V _{T+}	Positive-going threshold			2.7 V	0.8		2	V
				3 V	0.9		2	
				3.6 V	1.1		2	
V _{T–}	Negative-going threshold			2.7 V	0.4		1.4	V
				3 V	0.6		1.5	
				3.6 V	0.8		1.7	

6.6 Electrical Characteristics, SN54LVC14A (continued)

over operating free-air temperature range (unless otherwise noted)

PARAMETER	TEST CONDITIONS	V _{CC}	SN54LVC14A			UNIT
			–55 TO +125°C			
			MIN	TYP	MAX	
ΔV_T Hysteresis ($V_{T+} - V_{T-}$)		2.7 V	0.3	1.1	V	
		3 V	0.3	1.2		
		3.6 V	0.3	1.2		
V _{OH}	I _{OH} = –100 μ A	2.7 V to 3.6 V	V _{CC} – 0.2		V	
	V _{OL}	2.7 V	2.2			
		I _I	2.4			
	I _{CC}	3 V	2.2			
ΔI_{CC}	I _{OL} = 100 μ A	2.7 V to 3.6 V	0.2		V	
	C _i	2.7 V	0.4			
	I _{OL} = 24 mA	3 V	0.55			
	V _I = 5.5 V or GND	3.6 V	± 5		μ A	
	V _I = V _{CC} or GND, I _O = 0	3.6 V	10		μ A	
	One input at V _{CC} – 0.6 V, Other inputs at V _{CC} or GND	2.7 V to 3.6 V	500		μ A	
	V _I = V _{CC} or GND	3.3 V	5 ⁽¹⁾		pF	

(1) T_A = 25°C

6.7 Electrical Characteristics, SN74LVC14A

over operating free-air temperature range (unless otherwise noted)

PARAMETER	TEST CONDITIONS	V _{CC}	SN74LVC14A						UNIT	
			T _A = 25°C			–40 TO +85°C		–40 TO +125°C		
			MIN	TYP	MAX	MIN	MAX	MIN		MAX
V _{T+} Positive-going threshold		1.65 V	0.4	1.3	0.4	1.3	0.4	1.3	V	
		1.95 V	0.6	1.5	0.6	1.5	0.6	1.5		
		2.3 V	0.8	1.7	0.8	1.7	0.8	1.7		
		2.5 V	0.8	1.7	0.8	1.7	0.8	1.7		
		2.7 V	0.8	2	0.8	2	0.8	2		
		3 V	0.9	2	0.9	2	0.9	2		
		3.6 V	1.1	2	1.1	2	1.1	2		
V _{T–} Negative-going threshold		1.65 V	0.15	0.85	0.15	0.85	0.15	0.85	V	
		1.95 V	0.25	0.95	0.25	0.95	0.25	0.95		
		2.3 V	0.4	1.2	0.4	1.2	0.4	1.2		
		2.5 V	0.4	1.2	0.4	1.2	0.4	1.2		
		2.7 V	0.4	1.4	0.4	1.4	0.4	1.4		
		3 V	0.6	1.5	0.6	1.5	0.6	1.5		
		3.6 V	0.8	1.7	0.8	1.7	0.8	1.7		

6.7 Electrical Characteristics, SN74LVC14A (continued)

over operating free-air temperature range (unless otherwise noted)

PARAMETER	TEST CONDITIONS	V _{CC}	SN74LVC14A						UNIT	
			T _A = 25°C			–40 TO +85°C		–40 TO +125°C		
			MIN	TYP	MAX	MIN	MAX	MIN		MAX
ΔV _T Hysteresis (V _{T+} – V _{T–})		1.65 V	0.1		1.15	0.1	1.15	0.1	1.15	V
		1.95 V	0.15		1.25	0.15	1.25	0.15	1.25	
		2.3 V	0.25		1.3	0.25	1.3	0.25	1.3	
		2.5 V	0.25		1.3	0.25	1.3	0.25	1.3	
		2.7 V	0.3		1.1	0.3	1.1	0.3	1.1	
		3 V	0.3		1.2	0.3	1.2	0.3	1.2	
		3.6 V	0.3		1.2	0.3	1.2	0.3	1.2	
V _{OH}	I _{OH} = –100 μA	1.65 V to 3.6 V	V _{CC} – 0.2		V _{CC} – 0.2		V _{CC} – 0.3		V	
	I _{OH} = –4 mA	1.65 V	1.29		1.2		1.05			
	I _{OH} = –8 mA	2.3 V	1.9		1.7		1.65			
	I _{OH} = –12 mA	2.7 V	2.2		2.2		2.05			
		3 V	2.4		2.4		2.25			
	I _{OH} = –24 mA	3 V	2.3		2.2		2			
V _{OL}	I _{OL} = 100 μA	1.65 V to 3.6 V			0.1		0.2		V	
	I _{OL} = 4 mA	1.65 V			0.24		0.45			
	I _{OL} = 8 mA	2.3 V			0.3		0.7			
	I _{OL} = 12 mA	2.7 V			0.4		0.4			
	I _{OL} = 24 mA	3 V			0.55		0.55			
I _I	V _I = 5.5 V or GND	3.6 V			±1		±5		μA	
I _{CC}	V _I = V _{CC} or GND, I _O = 0	3.6 V			1		10		40 μA	
ΔI _{CC}	One input at V _{CC} – 0.6 V, Other inputs at V _{CC} or GND	2.7 V to 3.6 V			500		500		5000 μA	
C _i	V _I = V _{CC} or GND	3.3 V			5				pF	

6.8 Switching Characteristics, SN54LVC14A

over operating free-air temperature range (unless otherwise noted) (see [Figure 7-1](#))

PARAMETER	FROM (INPUT)	TO (OUTPUT)	V _{CC}	SN54LVC14A		UNIT
				–55 TO +125°C		
				MIN	MAX	
t _{pd}	A	Y	2.7 V	7.5		ns
			3.3 V ± 0.3 V	1	6.4	

6.9 Switching Characteristics, SN74LVC14A

over operating free-air temperature range (unless otherwise noted) (see Figure 7-1)

PARAMETER	FROM (INPUT)	TO (OUTPUT)	V _{CC}	SN74LVC14A						UNIT	
				T _A = 25°C			-40 TO +85°C		-40 TO +125°C		
				MIN	TYP	MAX	MIN	MAX	MIN		MAX
t _{pd}	A	Y	1.8 V ± 0.15 V	1	5	10.5	1	11	1	13	ns
			2.5 V ± 0.2 V	1	3.4	7.3	1	7.8	1	10	
			2.7 V	1	3.6	7.3	1	7.5	1	9.5	
			3.3 V ± 0.3 V	1	3.2	6.2	1	6.4	1	8	
t _{sk(o)}			3.3 V ± 0.3 V			1		1		1.5	ns

6.10 Operating Characteristics

T_A = 25°C

PARAMETER	TEST CONDITIONS	V _{CC} = 1.8 V	V _{CC} = 2.5 V	V _{CC} = 3.3 V	UNIT
		TYP	TYP	TYP	
C _{pd} Power dissipation capacitance	f = 10 MHz	11	12	15	pF

6.11 Typical Characteristics

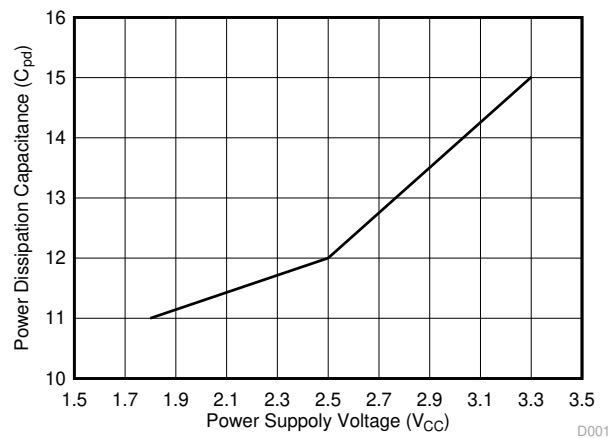
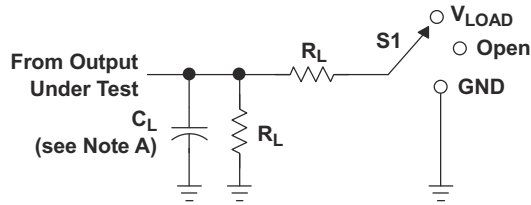

Figure 6-1. Power Dissipation Capacitance vs. Power Supply Voltage

7 Parameter Measurement Information



LOAD CIRCUIT

TEST	S1
t_{PLH}/t_{PHL}	Open
t_{PLZ}/t_{PZL}	V_{LOAD}
t_{PHZ}/t_{PZH}	GND

V_{CC}	INPUTS		V_M	V_{LOAD}	C_L	R_L	V_D
	V_I	t_r/t_f					
$1.8\text{ V} \pm 0.15\text{ V}$	V_{CC}	$\leq 2\text{ ns}$	$V_{CC}/2$	$2 \times V_{CC}$	30 pF	1 kW	0.15 V
$2.5\text{ V} \pm 0.2\text{ V}$	V_{CC}	$\leq 2\text{ ns}$	$V_{CC}/2$	$2 \times V_{CC}$	30 pF	500 W	0.15 V
2.7 V	2.7 V	$\leq 2.5\text{ ns}$	1.5 V	6 V	50 pF	500 W	0.3 V
$3.3\text{ V} \pm 0.3\text{ V}$	2.7 V	$\leq 2.5\text{ ns}$	1.5 V	6 V	50 pF	500 W	0.3 V

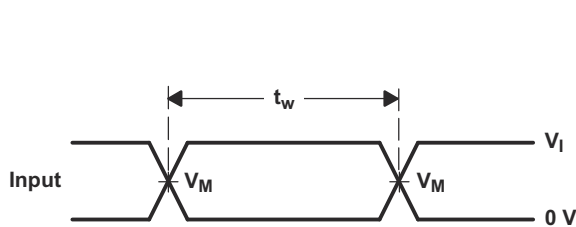

VOLTAGE WAVEFORMS
PULSE DURATION

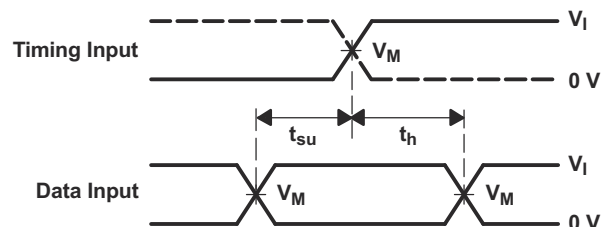

VOLTAGE WAVEFORMS
SETUP AND HOLD TIMES

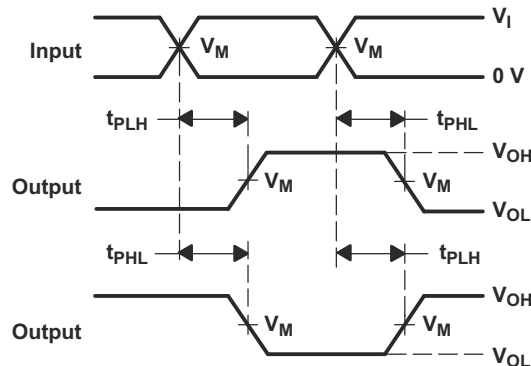

VOLTAGE WAVEFORMS
PROPAGATION DELAY TIMES
INVERTING AND NONINVERTING OUTPUTS

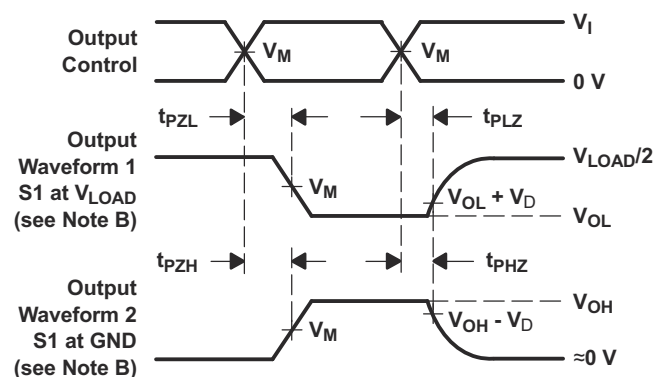

VOLTAGE WAVEFORMS
ENABLE AND DISABLE TIMES
LOW- AND HIGH-LEVEL ENABLING

- NOTES:
- C_L includes probe and jig capacitance.
 - Waveform 1 is for an output with internal conditions such that the output is low except when disabled by the output control. Waveform 2 is for an output with internal conditions such that the output is high, except when disabled by the output control.
 - All input pulses are supplied by generators having the following characteristics: $PRR \leq 10\text{ MHz}$, $Z_O = 50\text{ W}$.
 - The outputs are measured one at a time, with one transition per measurement.
 - t_{PLZ} and t_{PHZ} are the same as t_{dis} .
 - t_{PZL} and t_{PZH} are the same as t_{en} .
 - t_{PLH} and t_{PHL} are the same as t_{pd} .
 - All parameters and waveforms are not applicable to all devices.

Figure 7-1. Load Circuit and Voltage Waveforms

8 Detailed Description

8.1 Overview

The SN54LVC14A hex Schmitt-trigger inverter is designed for 2.7-V to 3.6-V V_{CC} operation, and the SN74LVC14A hex Schmitt-trigger inverter is designed for 1.65-V to 3.6-V V_{CC} operation.

The devices contain six independent inverters and perform the Boolean function $Y = \bar{A}$.

Inputs can be driven from either 3.3-V or 5-V devices. This feature allows the use of these devices as translators in a mixed 3.3-V or 5-V system environment.

8.2 Functional Block Diagram



Figure 8-1. Logic Diagram, Each Inverter (Positive Logic)

8.3 Feature Description

8.3.1 Balanced High-Drive CMOS Push-Pull Outputs

A balanced output allows the device to sink and source similar currents. The high drive capability of this device creates fast edges into light loads so routing and load conditions should be considered to prevent ringing. Additionally, the outputs of this device are capable of driving larger currents than the device can sustain without being damaged. It is important for the power output of the device to be limited to avoid thermal runaway and damage due to over-current. The electrical and thermal limits defined in the [Absolute Maximum Ratings](#) section must be followed at all times.

8.3.2 CMOS Schmitt-Trigger Inputs

This device includes inputs with the Schmitt-trigger architecture. These inputs are high impedance and are typically modeled as a resistor in parallel with the input capacitance given in the *Electrical Characteristics* table from the input to ground. The worst case resistance is calculated with the maximum input voltage, given in the *Absolute Maximum Ratings* table, and the maximum input leakage current, given in the *Electrical Characteristics* table, using Ohm's law ($R = V \div I$).

The Schmitt-trigger input architecture provides hysteresis as defined by ΔV_T in the *Electrical Characteristics* table, which makes this device extremely tolerant to slow or noisy inputs. While the inputs can be driven much slower than standard CMOS inputs, it is still recommended to properly terminate unused inputs. Driving the inputs with slow transitioning signals will increase dynamic current consumption of the device. For additional information regarding Schmitt-trigger inputs, please see [Understanding Schmitt Triggers](#).

8.3.3 Clamp Diodes

The inputs to this device have negative clamping diodes. The outputs to this device have both positive and negative clamping diodes as shown in [Figure 8-2](#).

CAUTION

Voltages beyond the values specified in the [Absolute Maximum Ratings](#) table can cause damage to the device. The input negative-voltage and output voltage ratings may be exceeded if the input and output clamp-current ratings are observed.

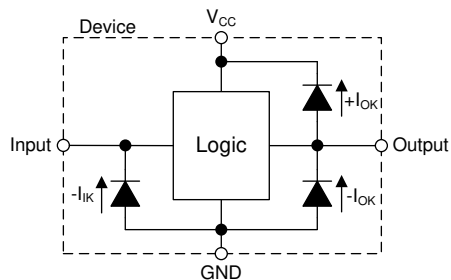

Figure 8-2. Electrical Placement of Clamping Diodes for Each Input and Output

8.3.4 Over-Voltage Tolerant Inputs

Input signals to this device can be driven above the supply voltage so long as they remain below the maximum input voltage value specified in the [Absolute Maximum Ratings table](#).

8.4 Device Functional Modes

[Table 8-1](#) lists the functional modes for the SN54LVC14A and SN74LVC14A devices.

Table 8-1. Function Table (Each Inverter)

INPUT A	OUTPUT Y
H	L
L	H

9 Application and Implementation

Note

Information in the following applications sections is not part of the TI component specification, and TI does not warrant its accuracy or completeness. TI's customers are responsible for determining suitability of components for their purposes, as well as validating and testing their design implementation to confirm system functionality.

9.1 Application Information

Physically interactive interface elements like push buttons or rotary knobs offer simple and easy ways to interact with an electronic system. Many of these physical interface elements often have issues with bouncing, or where the physical conductive contact can connect and disconnect multiple times during a button push or release. This bouncing can cause one or more faulty transient signals to be passed during this transitional period. These faulty signals can be observed in many common applications: for example, a television remote with bouncing error can adjust the TV channel multiple times despite the button being pushed only once. To mitigate these faulty signals, use a Schmitt-trigger, or a device with hysteresis, to remove these faulty signals. Hysteresis allows a device to *remember* its history, and in this case, the LVC14A uses this memory to debounce the physical element's signal, or filter the faulty transient signals and pass only the valid signal each time the element is used. In this example, we show a push button signal passed through an LVC14A that is debounced and inverted to the MCU for push detection.

9.2 Typical Application

The signal effects of the debounce circuit can be seen when comparing [Figure 9-2](#) and [Figure 9-3](#). In [Figure 9-2](#), the input is a very poor quality signal due to the error in the physical push button. If the MCU attempts to sample this input to detect a push, there is high probability that multiple push events will be falsely detected. Once the debounce circuit has been implemented, the input is cleaned up, and the MCU can perform push detection without any error, as seen in [Figure 9-3](#).

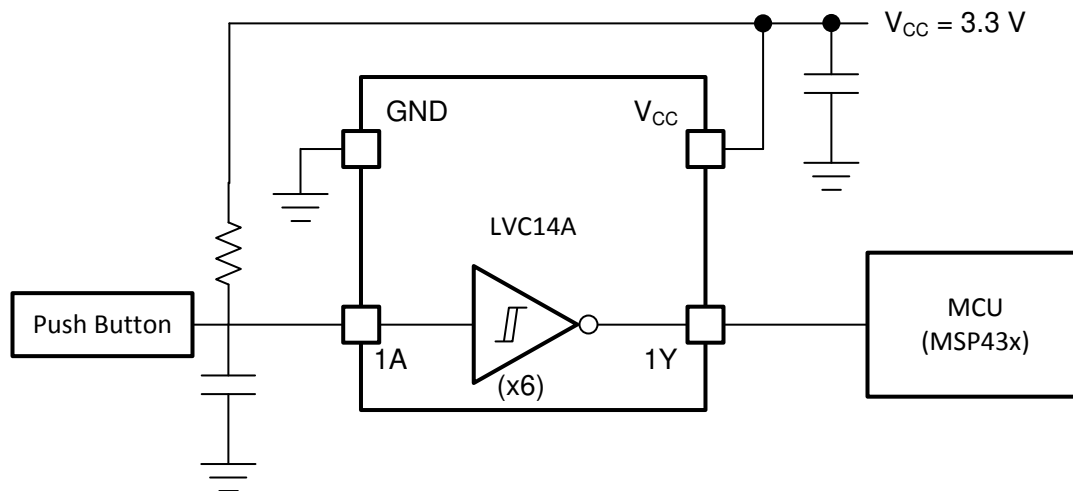

Copyright © 2017, Texas Instruments Incorporated

Figure 9-1. Debouncer Application Diagram

9.2.1 Design Requirements

The SN74LVC14A device uses CMOS technology and has balanced output drive. Take care to avoid bus contention because it can drive currents that would exceed maximum limits.

The SN74LVC14A allows for performing logical Boolean functions with hysteresis using digital signals. All input signals should remain as close as possible to either 0 V or V_{CC} for optimal operation.

9.2.2 Detailed Design Procedure

- Recommended input conditions:
 - For specified high and low levels, see V_{IH} and V_{IL} in the [Recommended Operating Conditions: SN74LVC14A](#) table.
 - Inputs and outputs are overvoltage tolerant and can therefore go as high as 3.6 V at any valid V_{CC} .
- Recommended output conditions:
 - Load currents should not exceed ± 50 mA.
- Frequency selection criterion:
 - Added trace resistance and capacitance can reduce maximum frequency capability; follow the layout practices listed in the [Layout](#) section

9.2.3 Application Curves

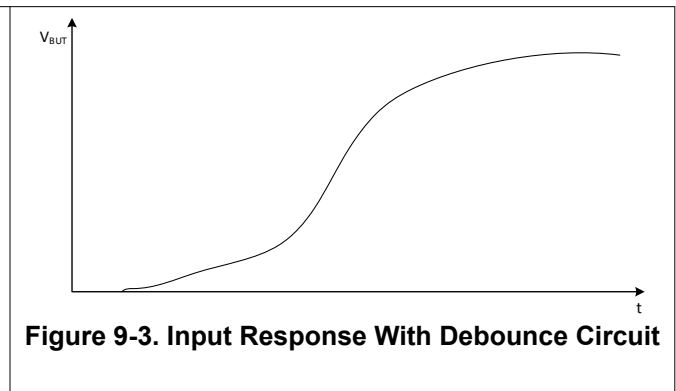
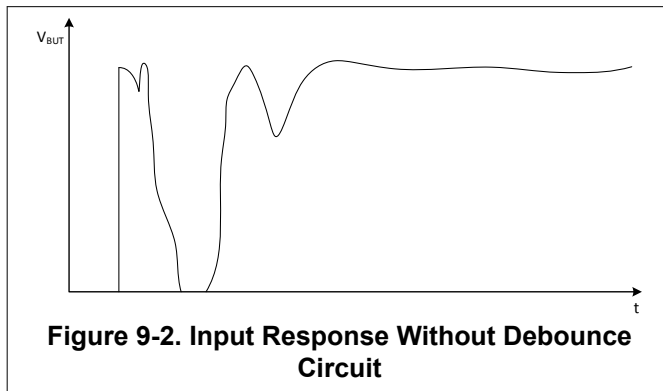

10 Power Supply Recommendations

The power supply can be any voltage between the minimum and maximum supply voltage rating listed in the [Absolute Maximum Ratings](#) table.

Each V_{CC} terminal should have a good bypass capacitor to prevent power disturbance. For devices with a single supply, a 0.1- μF bypass capacitor is recommended. If multiple pins are labeled V_{CC} , then a 0.01- μF or 0.022- μF capacitor is recommended for each V_{CC} because the V_{CC} pins are tied together internally. For devices with dual supply pins operating at different voltages, for example V_{CC} and V_{DD} , a 0.1- μF bypass capacitor is recommended for each supply pin. To reject different frequencies of noise, use multiple bypass capacitors in parallel. Capacitors with values of 0.1 μF and 1 μF are commonly used in parallel. The bypass capacitor should be installed as close to the power terminal as possible for best results.

11 Layout

11.1 Layout Guidelines

When using multiple-bit logic devices, inputs must never float.

In many cases, functions (or parts of functions) of digital logic devices are unused, for example, when only two inputs of a triple-input AND gate are used or when only 3 of the 4 buffer gates are used. Such input pins must not be left unconnected, because the undefined voltages at the outside connections result in undefined operational states. [Figure 11-1](#) specifies the rules that must be observed under all circumstances. All unused inputs of digital logic devices must be connected to a high or low bias to prevent them from floating. The logic level that must be applied to any particular unused input depends on the function of the device. Generally they are tied to GND or V_{CC} , whichever makes more sense or is more convenient. It is generally acceptable to float outputs, unless the part is a transceiver. If the transceiver has an output enable pin, it disables the output section of the part when asserted, which does not disable the input section of the I/Os. Therefore, the I/Os cannot float when disabled.

11.2 Layout Examples

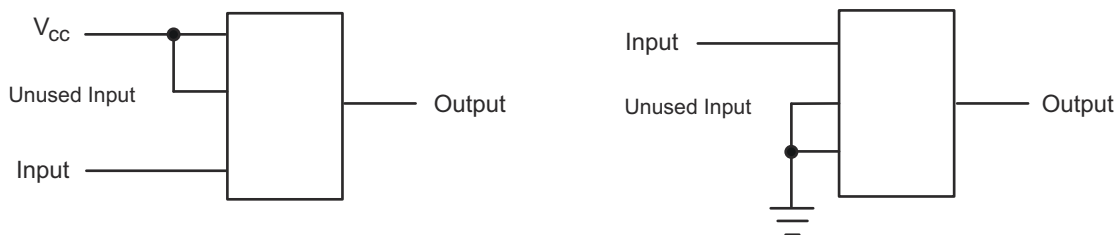

Figure 11-1. Layout Diagrams

12 Device and Documentation Support

12.1 Documentation Support

12.1.1 Related Documentation

For related documentation, see the following:

- Texas Instruments, [Implications of Slow or Floating CMOS Inputs application report](#)

12.2 Receiving Notification of Documentation Updates

To receive notification of documentation updates, navigate to the device product folder on [ti.com](#). Click on *Subscribe to updates* to register and receive a weekly digest of any product information that has changed. For change details, review the revision history included in any revised document.

12.3 Support Resources

TI E2E™ [support forums](#) are an engineer's go-to source for fast, verified answers and design help — straight from the experts. Search existing answers or ask your own question to get the quick design help you need.

Linked content is provided "AS IS" by the respective contributors. They do not constitute TI specifications and do not necessarily reflect TI's views; see TI's [Terms of Use](#).

12.4 Trademarks

TI E2E™ is a trademark of Texas Instruments.

All trademarks are the property of their respective owners.

12.5 Electrostatic Discharge Caution



This integrated circuit can be damaged by ESD. Texas Instruments recommends that all integrated circuits be handled with appropriate precautions. Failure to observe proper handling and installation procedures can cause damage.

ESD damage can range from subtle performance degradation to complete device failure. Precision integrated circuits may be more susceptible to damage because very small parametric changes could cause the device not to meet its published specifications.

12.6 Glossary

[TI Glossary](#) This glossary lists and explains terms, acronyms, and definitions.

13 Mechanical, Packaging, and Orderable Information

The following pages include mechanical packaging and orderable information. This information is the most current data available for the designated devices. This data is subject to change without notice and revision of this document. For browser based versions of this data sheet, refer to the left hand navigation.

PACKAGING INFORMATION

Orderable Device	Status (1)	Package Type	Package Drawing	Pins	Package Qty	Eco Plan (2)	Lead finish/ Ball material (6)	MSL Peak Temp (3)	Op Temp (°C)	Device Marking (4/5)	Samples
5962-9761501Q2A	ACTIVE	LCCC	FK	20	55	Non-RoHS & Green	SNPB	N / A for Pkg Type	-55 to 125	5962-9761501Q2A SNJ54LVC14AFK	Samples
5962-9761501QCA	ACTIVE	CDIP	J	14	25	Non-RoHS & Green	SNPB	N / A for Pkg Type	-55 to 125	5962-9761501QC A SNJ54LVC14AJ	Samples
5962-9761501QDA	ACTIVE	CFP	W	14	25	Non-RoHS & Green	SNPB	N / A for Pkg Type	-55 to 125	5962-9761501QD A SNJ54LVC14AW	Samples
5962-9761501V2A	ACTIVE	LCCC	FK	20	55	Non-RoHS & Green	SNPB	N / A for Pkg Type	-55 to 125	5962-9761501V2A SNV54LVC14AFK	Samples
5962-9761501VCA	ACTIVE	CDIP	J	14	25	Non-RoHS & Green	SNPB	N / A for Pkg Type	-55 to 125	5962-9761501VC A SNV54LVC14AJ	Samples
5962-9761501VDA	ACTIVE	CFP	W	14	25	Non-RoHS & Green	SNPB	N / A for Pkg Type	-55 to 125	5962-9761501VD A SNV54LVC14AW	Samples
SN74LVC14AD	ACTIVE	SOIC	D	14	50	RoHS & Green	NIPDAU	Level-1-260C-UNLIM	-40 to 125	LVC14A	Samples
SN74LVC14ADBR	ACTIVE	SSOP	DB	14	2000	RoHS & Green	NIPDAU	Level-1-260C-UNLIM	-40 to 125	LC14A	Samples
SN74LVC14ADBRE4	ACTIVE	SSOP	DB	14	2000	RoHS & Green	NIPDAU	Level-1-260C-UNLIM	-40 to 125	LC14A	Samples
SN74LVC14ADE4	ACTIVE	SOIC	D	14	50	RoHS & Green	NIPDAU	Level-1-260C-UNLIM	-40 to 125	LVC14A	Samples
SN74LVC14ADG4	ACTIVE	SOIC	D	14	50	RoHS & Green	NIPDAU	Level-1-260C-UNLIM	-40 to 125	LVC14A	Samples
SN74LVC14ADGVR	ACTIVE	TVSOP	DGV	14	2000	RoHS & Green	NIPDAU	Level-1-260C-UNLIM	-40 to 125	LC14A	Samples
SN74LVC14ADR	ACTIVE	SOIC	D	14	2500	RoHS & Green	NIPDAU SN	Level-1-260C-UNLIM	-40 to 125	LVC14A	Samples
SN74LVC14ADRE4	ACTIVE	SOIC	D	14	2500	RoHS & Green	NIPDAU	Level-1-260C-UNLIM	-40 to 125	LVC14A	Samples
SN74LVC14ADRG3	ACTIVE	SOIC	D	14	2500	RoHS & Green	SN	Level-1-260C-UNLIM	-40 to 125	LVC14A	Samples

Orderable Device	Status (1)	Package Type	Package Drawing	Pins	Package Qty	Eco Plan (2)	Lead finish/ Ball material (6)	MSL Peak Temp (3)	Op Temp (°C)	Device Marking (4/5)	Samples
SN74LVC14ADRG4	ACTIVE	SOIC	D	14	2500	RoHS & Green	NIPDAU	Level-1-260C-UNLIM	-40 to 125	LVC14A	Samples
SN74LVC14ADT	ACTIVE	SOIC	D	14	250	RoHS & Green	NIPDAU	Level-1-260C-UNLIM	-40 to 125	LVC14A	Samples
SN74LVC14ANSR	ACTIVE	SOP	NS	14	2000	RoHS & Green	NIPDAU	Level-1-260C-UNLIM	-40 to 125	LVC14A	Samples
SN74LVC14APW	ACTIVE	TSSOP	PW	14	90	RoHS & Green	NIPDAU	Level-1-260C-UNLIM	-40 to 125	LC14A	Samples
SN74LVC14APWG4	ACTIVE	TSSOP	PW	14	90	RoHS & Green	NIPDAU	Level-1-260C-UNLIM	-40 to 125	LC14A	Samples
SN74LVC14APWR	ACTIVE	TSSOP	PW	14	2000	RoHS & Green	NIPDAU SN	Level-1-260C-UNLIM	-40 to 125	LC14A	Samples
SN74LVC14APWRE4	ACTIVE	TSSOP	PW	14	2000	RoHS & Green	NIPDAU	Level-1-260C-UNLIM	-40 to 125	LC14A	Samples
SN74LVC14APWRG3	ACTIVE	TSSOP	PW	14	2000	RoHS & Green	SN	Level-1-260C-UNLIM	-40 to 125	LC14A	Samples
SN74LVC14APWRG4	ACTIVE	TSSOP	PW	14	2000	RoHS & Green	NIPDAU	Level-1-260C-UNLIM	-40 to 125	LC14A	Samples
SN74LVC14APWT	ACTIVE	TSSOP	PW	14	250	RoHS & Green	NIPDAU	Level-1-260C-UNLIM	-40 to 125	LC14A	Samples
SN74LVC14APWTG4	ACTIVE	TSSOP	PW	14	250	RoHS & Green	NIPDAU	Level-1-260C-UNLIM	-40 to 125	LC14A	Samples
SN74LVC14ARGYR	ACTIVE	VQFN	RGY	14	3000	RoHS & Green	NIPDAU	Level-2-260C-1 YEAR	-40 to 125	LC14A	Samples
SN74LVC14ARGYRG4	ACTIVE	VQFN	RGY	14	3000	RoHS & Green	NIPDAU	Level-2-260C-1 YEAR	-40 to 125	LC14A	Samples
SNJ54LVC14AFK	ACTIVE	LCCC	FK	20	55	Non-RoHS & Green	SNPB	N / A for Pkg Type	-55 to 125	5962-9761501Q2A SNJ54LVC14AFK	Samples
SNJ54LVC14AJ	ACTIVE	CDIP	J	14	25	Non-RoHS & Green	SNPB	N / A for Pkg Type	-55 to 125	5962-9761501QC A SNJ54LVC14AJ	Samples
SNJ54LVC14AW	ACTIVE	CFP	W	14	25	Non-RoHS & Green	SNPB	N / A for Pkg Type	-55 to 125	5962-9761501QD A SNJ54LVC14AW	Samples

(1) The marketing status values are defined as follows:

ACTIVE: Product device recommended for new designs.

LIFEBUY: TI has announced that the device will be discontinued, and a lifetime-buy period is in effect.

NRND: Not recommended for new designs. Device is in production to support existing customers, but TI does not recommend using this part in a new design.

PREVIEW: Device has been announced but is not in production. Samples may or may not be available.

OBSELETE: TI has discontinued the production of the device.

⁽²⁾ **RoHS:** TI defines "RoHS" to mean semiconductor products that are compliant with the current EU RoHS requirements for all 10 RoHS substances, including the requirement that RoHS substance do not exceed 0.1% by weight in homogeneous materials. Where designed to be soldered at high temperatures, "RoHS" products are suitable for use in specified lead-free processes. TI may reference these types of products as "Pb-Free".

RoHS Exempt: TI defines "RoHS Exempt" to mean products that contain lead but are compliant with EU RoHS pursuant to a specific EU RoHS exemption.

Green: TI defines "Green" to mean the content of Chlorine (Cl) and Bromine (Br) based flame retardants meet JS709B low halogen requirements of ≤ 1000 ppm threshold. Antimony trioxide based flame retardants must also meet the ≤ 1000 ppm threshold requirement.

⁽³⁾ MSL, Peak Temp. - The Moisture Sensitivity Level rating according to the JEDEC industry standard classifications, and peak solder temperature.

⁽⁴⁾ There may be additional marking, which relates to the logo, the lot trace code information, or the environmental category on the device.

⁽⁵⁾ Multiple Device Markings will be inside parentheses. Only one Device Marking contained in parentheses and separated by a "~" will appear on a device. If a line is indented then it is a continuation of the previous line and the two combined represent the entire Device Marking for that device.

⁽⁶⁾ Lead finish/Ball material - Orderable Devices may have multiple material finish options. Finish options are separated by a vertical ruled line. Lead finish/Ball material values may wrap to two lines if the finish value exceeds the maximum column width.

Important Information and Disclaimer:The information provided on this page represents TI's knowledge and belief as of the date that it is provided. TI bases its knowledge and belief on information provided by third parties, and makes no representation or warranty as to the accuracy of such information. Efforts are underway to better integrate information from third parties. TI has taken and continues to take reasonable steps to provide representative and accurate information but may not have conducted destructive testing or chemical analysis on incoming materials and chemicals. TI and TI suppliers consider certain information to be proprietary, and thus CAS numbers and other limited information may not be available for release.

In no event shall TI's liability arising out of such information exceed the total purchase price of the TI part(s) at issue in this document sold by TI to Customer on an annual basis.

OTHER QUALIFIED VERSIONS OF SN54LVC14A, SN54LVC14A-SP, SN74LVC14A :

- Catalog : [SN74LVC14A](#), [SN54LVC14A](#)
- Automotive : [SN74LVC14A-Q1](#), [SN74LVC14A-Q1](#)
- Enhanced Product : [SN74LVC14A-EP](#), [SN74LVC14A-EP](#)
- Military : [SN54LVC14A](#)
- Space : [SN54LVC14A-SP](#)

NOTE: Qualified Version Definitions:

- Catalog - TI's standard catalog product
- Automotive - Q100 devices qualified for high-reliability automotive applications targeting zero defects
- Enhanced Product - Supports Defense, Aerospace and Medical Applications
- Military - QML certified for Military and Defense Applications
- Space - Radiation tolerant, ceramic packaging and qualified for use in Space-based application

TAPE AND REEL INFORMATION



QUADRANT ASSIGNMENTS FOR PIN 1 ORIENTATION IN TAPE

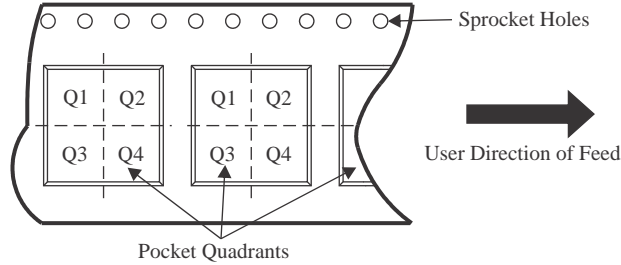

*All dimensions are nominal

Device	Package Type	Package Drawing	Pins	SPQ	Reel Diameter (mm)	Reel Width W1 (mm)	A0 (mm)	B0 (mm)	K0 (mm)	P1 (mm)	W (mm)	Pin1 Quadrant
SN74LVC14ADBR	SSOP	DB	14	2000	330.0	16.4	8.35	6.6	2.4	12.0	16.0	Q1
SN74LVC14ADGVR	TVSOP	DGV	14	2000	330.0	12.4	6.8	4.0	1.6	8.0	12.0	Q1
SN74LVC14ADR	SOIC	D	14	2500	330.0	16.4	6.5	9.0	2.1	8.0	16.0	Q1
SN74LVC14ADRG3	SOIC	D	14	2500	330.0	16.8	6.5	9.5	2.1	8.0	16.0	Q1
SN74LVC14ADRG4	SOIC	D	14	2500	330.0	16.4	6.5	9.0	2.1	8.0	16.0	Q1
SN74LVC14ADRG4	SOIC	D	14	2500	330.0	16.4	6.5	9.0	2.1	8.0	16.0	Q1
SN74LVC14ADT	SOIC	D	14	250	330.0	16.4	6.5	9.0	2.1	8.0	16.0	Q1
SN74LVC14ANSR	SOP	NS	14	2000	330.0	16.4	8.2	10.5	2.5	12.0	16.0	Q1
SN74LVC14APWR	TSSOP	PW	14	2000	330.0	12.4	6.9	5.6	1.6	8.0	12.0	Q1
SN74LVC14APWRG3	TSSOP	PW	14	2000	330.0	12.4	6.9	5.6	1.6	8.0	12.0	Q1
SN74LVC14APWRG4	TSSOP	PW	14	2000	330.0	12.4	6.9	5.6	1.6	8.0	12.0	Q1
SN74LVC14APWT	TSSOP	PW	14	250	330.0	12.4	6.9	5.6	1.6	8.0	12.0	Q1
SN74LVC14ARGYR	VQFN	RGY	14	3000	330.0	12.4	3.75	3.75	1.15	8.0	12.0	Q1

TAPE AND REEL BOX DIMENSIONS

*All dimensions are nominal

Device	Package Type	Package Drawing	Pins	SPQ	Length (mm)	Width (mm)	Height (mm)
SN74LVC14ADBR	SSOP	DB	14	2000	356.0	356.0	35.0
SN74LVC14ADGVR	TVSOP	DGV	14	2000	356.0	356.0	35.0
SN74LVC14ADR	SOIC	D	14	2500	353.0	353.0	32.0
SN74LVC14ADRG3	SOIC	D	14	2500	364.0	364.0	27.0
SN74LVC14ADRG4	SOIC	D	14	2500	356.0	356.0	35.0
SN74LVC14ADRG4	SOIC	D	14	2500	340.5	336.1	32.0
SN74LVC14ADT	SOIC	D	14	250	210.0	185.0	35.0
SN74LVC14ANSR	SOP	NS	14	2000	356.0	356.0	35.0
SN74LVC14APWR	TSSOP	PW	14	2000	356.0	356.0	35.0
SN74LVC14APWRG3	TSSOP	PW	14	2000	364.0	364.0	27.0
SN74LVC14APWRG4	TSSOP	PW	14	2000	356.0	356.0	35.0
SN74LVC14APWT	TSSOP	PW	14	250	356.0	356.0	35.0
SN74LVC14ARGYR	VQFN	RGY	14	3000	356.0	356.0	35.0

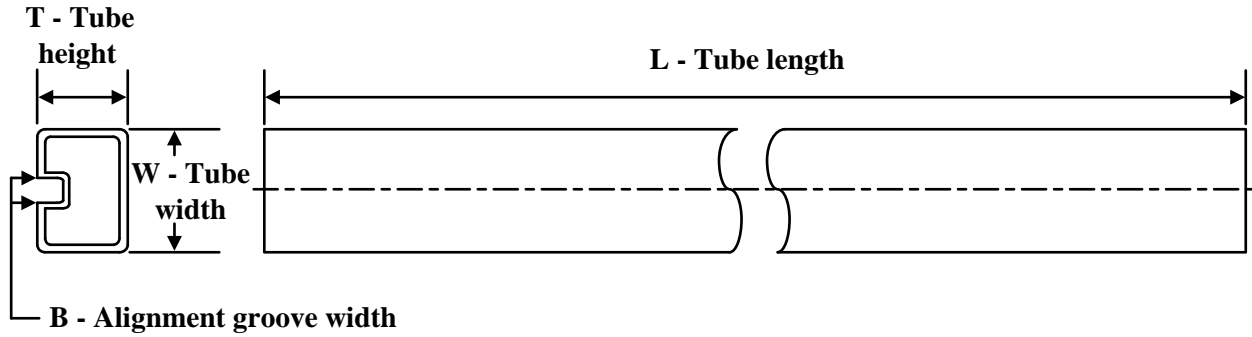
TUBE

*All dimensions are nominal

Device	Package Name	Package Type	Pins	SPQ	L (mm)	W (mm)	T (μm)	B (mm)
5962-9761501Q2A	FK	LCCC	20	55	506.98	12.06	2030	NA
5962-9761501QDA	W	CFP	14	25	506.98	26.16	6220	NA
5962-9761501V2A	FK	LCCC	20	55	506.98	12.06	2030	NA
5962-9761501VDA	W	CFP	14	25	506.98	26.16	6220	NA
SN74LVC14AD	D	SOIC	14	50	506.6	8	3940	4.32
SN74LVC14ADE4	D	SOIC	14	50	506.6	8	3940	4.32
SN74LVC14ADG4	D	SOIC	14	50	506.6	8	3940	4.32
SN74LVC14APW	PW	TSSOP	14	90	530	10.2	3600	3.5
SN74LVC14APWG4	PW	TSSOP	14	90	530	10.2	3600	3.5
SNJ54LVC14AFK	FK	LCCC	20	55	506.98	12.06	2030	NA
SNJ54LVC14AW	W	CFP	14	25	506.98	26.16	6220	NA

GENERIC PACKAGE VIEW

FK 20

LCCC - 2.03 mm max height

8.89 x 8.89, 1.27 mm pitch

LEADLESS CERAMIC CHIP CARRIER

This image is a representation of the package family, actual package may vary.
Refer to the product data sheet for package details.



4229370VA\

J 14

GENERIC PACKAGE VIEW
CDIP - 5.08 mm max height
CERAMIC DUAL IN LINE PACKAGE



Images above are just a representation of the package family, actual package may vary.
Refer to the product data sheet for package details.

4040083-5/G

J0014A



PACKAGE OUTLINE

CDIP - 5.08 mm max height

CERAMIC DUAL IN LINE PACKAGE



4214771/A 05/2017

NOTES:

1. All controlling linear dimensions are in inches. Dimensions in brackets are in millimeters. Any dimension in brackets or parenthesis are for reference only. Dimensioning and tolerancing per ASME Y14.5M.
2. This drawing is subject to change without notice.
3. This package is hermetically sealed with a ceramic lid using glass frit.
4. Index point is provided on cap for terminal identification only and on press ceramic glass frit seal only.
5. Falls within MIL-STD-1835 and GDIP1-T14.

EXAMPLE BOARD LAYOUT

J0014A

CDIP - 5.08 mm max height

CERAMIC DUAL IN LINE PACKAGE



LAND PATTERN EXAMPLE
NON-SOLDER MASK DEFINED
SCALE: 5X



4214771/A 05/2017

PW0014A



PACKAGE OUTLINE
TSSOP - 1.2 mm max height

SMALL OUTLINE PACKAGE



4220202/B 12/2023

NOTES:

1. All linear dimensions are in millimeters. Any dimensions in parenthesis are for reference only. Dimensioning and tolerancing per ASME Y14.5M.
2. This drawing is subject to change without notice.
3. This dimension does not include mold flash, protrusions, or gate burrs. Mold flash, protrusions, or gate burrs shall not exceed 0.15 mm per side.
4. This dimension does not include interlead flash. Interlead flash shall not exceed 0.25 mm per side.
5. Reference JEDEC registration MO-153.

EXAMPLE BOARD LAYOUT

PW0014A

TSSOP - 1.2 mm max height

SMALL OUTLINE PACKAGE



LAND PATTERN EXAMPLE
EXPOSED METAL SHOWN
SCALE: 10X



4220202/B 12/2023

NOTES: (continued)

- 6. Publication IPC-7351 may have alternate designs.
- 7. Solder mask tolerances between and around signal pads can vary based on board fabrication site.

EXAMPLE STENCIL DESIGN

PW0014A

TSSOP - 1.2 mm max height

SMALL OUTLINE PACKAGE



SOLDER PASTE EXAMPLE
BASED ON 0.125 mm THICK STENCIL
SCALE: 10X

4220202/B 12/2023

NOTES: (continued)

8. Laser cutting apertures with trapezoidal walls and rounded corners may offer better paste release. IPC-7525 may have alternate design recommendations.
9. Board assembly site may have different recommendations for stencil design.



D0014A

PACKAGE OUTLINE

SOIC - 1.75 mm max height

SMALL OUTLINE INTEGRATED CIRCUIT



4220718/A 09/2016

NOTES:

1. All linear dimensions are in millimeters. Dimensions in parenthesis are for reference only. Dimensioning and tolerancing per ASME Y14.5M.
2. This drawing is subject to change without notice.
3. This dimension does not include mold flash, protrusions, or gate burrs. Mold flash, protrusions, or gate burrs shall not exceed 0.15 mm, per side.
4. This dimension does not include interlead flash. Interlead flash shall not exceed 0.43 mm, per side.
5. Reference JEDEC registration MS-012, variation AB.

EXAMPLE BOARD LAYOUT

D0014A

SOIC - 1.75 mm max height

SMALL OUTLINE INTEGRATED CIRCUIT



LAND PATTERN EXAMPLE
SCALE:8X

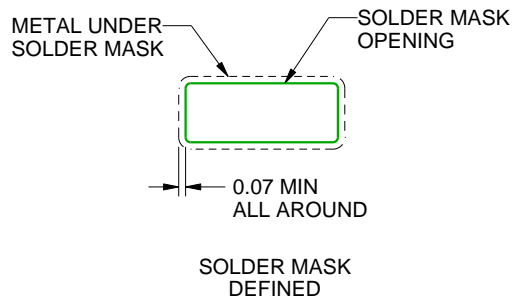
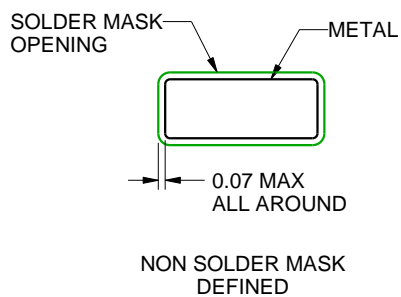

SOLDER MASK DETAILS

4220718/A 09/2016

NOTES: (continued)

6. Publication IPC-7351 may have alternate designs.
7. Solder mask tolerances between and around signal pads can vary based on board fabrication site.

EXAMPLE STENCIL DESIGN

D0014A

SOIC - 1.75 mm max height

SMALL OUTLINE INTEGRATED CIRCUIT



SOLDER PASTE EXAMPLE
BASED ON 0.125 mm THICK STENCIL
SCALE:8X

4220718/A 09/2016

NOTES: (continued)

8. Laser cutting apertures with trapezoidal walls and rounded corners may offer better paste release. IPC-7525 may have alternate design recommendations.
9. Board assembly site may have different recommendations for stencil design.

RGY (S-PVQFN-N14)

PLASTIC QUAD FLATPACK NO-LEAD

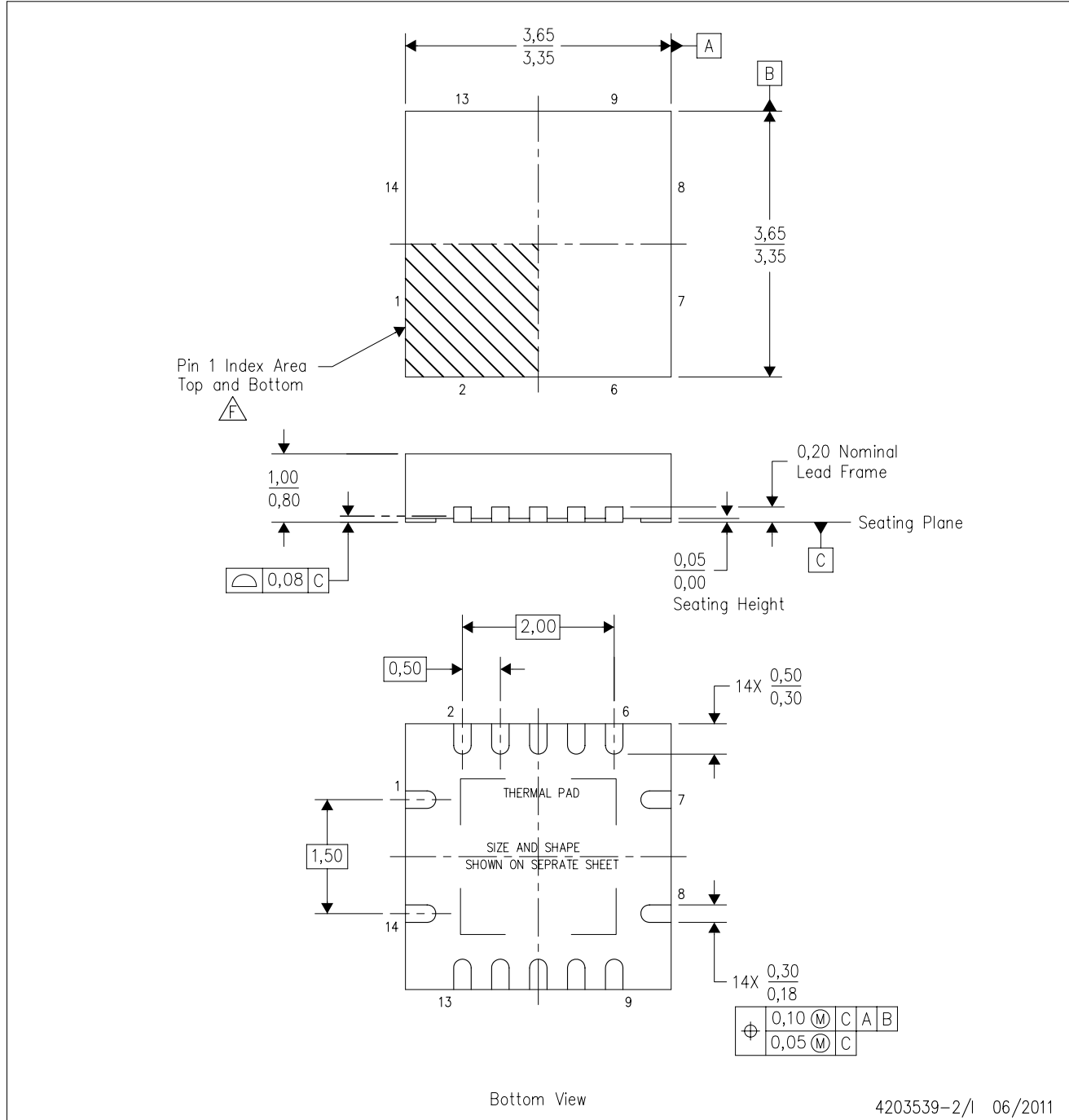

- NOTES:
- A. All linear dimensions are in millimeters. Dimensioning and tolerancing per ASME Y14.5M-1994.
 - B. This drawing is subject to change without notice.
 - C. QFN (Quad Flatpack No-Lead) package configuration.
 - D. The package thermal pad must be soldered to the board for thermal and mechanical performance.
 - E. See the additional figure in the Product Data Sheet for details regarding the exposed thermal pad features and dimensions.
 - F. Pin 1 identifiers are located on both top and bottom of the package and within the zone indicated. The Pin 1 identifiers are either a molded, marked, or metal feature.
 - G. Package complies to JEDEC MO-241 variation BA.

RGY (S-PVQFN-N14)

PLASTIC QUAD FLATPACK NO-LEAD

THERMAL INFORMATION

This package incorporates an exposed thermal pad that is designed to be attached directly to an external heatsink. The thermal pad must be soldered directly to the printed circuit board (PCB). After soldering, the PCB can be used as a heatsink. In addition, through the use of thermal vias, the thermal pad can be attached directly to the appropriate copper plane shown in the electrical schematic for the device, or alternatively, can be attached to a special heatsink structure designed into the PCB. This design optimizes the heat transfer from the integrated circuit (IC).

For information on the Quad Flatpack No-Lead (QFN) package and its advantages, refer to Application Report, QFN/SON PCB Attachment, Texas Instruments Literature No. SLUA271. This document is available at www.ti.com.

The exposed thermal pad dimensions for this package are shown in the following illustration.



Bottom View

Exposed Thermal Pad Dimensions

4206353-2/P 03/14

NOTE: All linear dimensions are in millimeters

RGY (S-PVQFN-N14)

PLASTIC QUAD FLATPACK NO-LEAD



4208122-2/P 03/14

- NOTES:
- All linear dimensions are in millimeters.
 - This drawing is subject to change without notice.
 - Publication IPC-7351 is recommended for alternate designs.
 - This package is designed to be soldered to a thermal pad on the board. Refer to Application Note, Quad Flat-Pack QFN/SON PCB Attachment, Texas Instruments Literature No. SLUA271, and also the Product Data Sheets for specific thermal information, via requirements, and recommended board layout. These documents are available at www.ti.com <<http://www.ti.com>>.
 - Laser cutting apertures with trapezoidal walls and also rounding corners will offer better paste release. Customers should contact their board assembly site for stencil design recommendations. Refer to IPC 7525 for stencil design considerations.
 - Customers should contact their board fabrication site for minimum solder mask web tolerances between signal pads.

MECHANICAL DATA

NS (R-PDSO-G**)

PLASTIC SMALL-OUTLINE PACKAGE

14-PINS SHOWN



- NOTES:
- A. All linear dimensions are in millimeters.
 - B. This drawing is subject to change without notice.
 - C. Body dimensions do not include mold flash or protrusion, not to exceed 0,15.

W (R-GDFP-F14)

CERAMIC DUAL FLATPACK



- NOTES:
- A. All linear dimensions are in inches (millimeters).
 - B. This drawing is subject to change without notice.
 - C. This package can be hermetically sealed with a ceramic lid using glass frit.
 - D. Index point is provided on cap for terminal identification only.
 - E. Falls within MIL STD 1835 GDFP1-F14

DGV (R-PDSO-G**)

PLASTIC SMALL-OUTLINE

24 PINS SHOWN



- NOTES: A. All linear dimensions are in millimeters.
 B. This drawing is subject to change without notice.
 C. Body dimensions do not include mold flash or protrusion, not to exceed 0,15 per side.
 D. Falls within JEDEC: 24/48 Pins – MO-153
 14/16/20/56 Pins – MO-194

DB0014A



PACKAGE OUTLINE

SSOP - 2 mm max height

SMALL OUTLINE PACKAGE



NOTES:

1. All linear dimensions are in millimeters. Any dimensions in parenthesis are for reference only. Dimensioning and tolerancing per ASME Y14.5M.
2. This drawing is subject to change without notice.
3. This dimension does not include mold flash, protrusions, or gate burrs. Mold flash, protrusions, or gate burrs shall not exceed 0.15 mm per side.
4. Reference JEDEC registration MO-150.

EXAMPLE BOARD LAYOUT

DB0014A

SSOP - 2 mm max height

SMALL OUTLINE PACKAGE



LAND PATTERN EXAMPLE
EXPOSED METAL SHOWN
SCALE: 10X

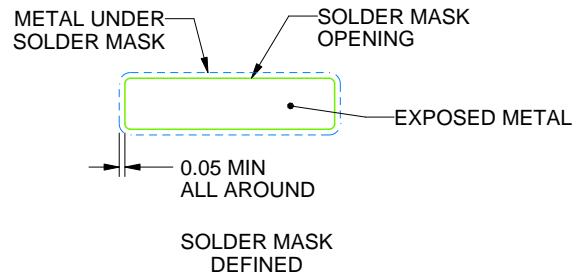
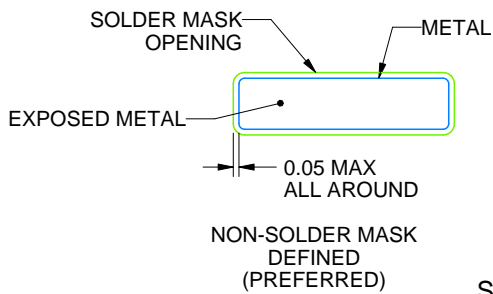

SOLDER MASK DETAILS

4220762/A 05/2024

NOTES: (continued)

5. Publication IPC-7351 may have alternate designs.
6. Solder mask tolerances between and around signal pads can vary based on board fabrication site.

EXAMPLE STENCIL DESIGN

DB0014A

SSOP - 2 mm max height

SMALL OUTLINE PACKAGE



SOLDER PASTE EXAMPLE
BASED ON 0.125 mm THICK STENCIL
SCALE: 10X

4220762/A 05/2024

NOTES: (continued)

7. Laser cutting apertures with trapezoidal walls and rounded corners may offer better paste release. IPC-7525 may have alternate design recommendations.
8. Board assembly site may have different recommendations for stencil design.

IMPORTANT NOTICE AND DISCLAIMER

TI PROVIDES TECHNICAL AND RELIABILITY DATA (INCLUDING DATA SHEETS), DESIGN RESOURCES (INCLUDING REFERENCE DESIGNS), APPLICATION OR OTHER DESIGN ADVICE, WEB TOOLS, SAFETY INFORMATION, AND OTHER RESOURCES "AS IS" AND WITH ALL FAULTS, AND DISCLAIMS ALL WARRANTIES, EXPRESS AND IMPLIED, INCLUDING WITHOUT LIMITATION ANY IMPLIED WARRANTIES OF MERCHANTABILITY, FITNESS FOR A PARTICULAR PURPOSE OR NON-INFRINGEMENT OF THIRD PARTY INTELLECTUAL PROPERTY RIGHTS.

These resources are intended for skilled developers designing with TI products. You are solely responsible for (1) selecting the appropriate TI products for your application, (2) designing, validating and testing your application, and (3) ensuring your application meets applicable standards, and any other safety, security, regulatory or other requirements.

These resources are subject to change without notice. TI grants you permission to use these resources only for development of an application that uses the TI products described in the resource. Other reproduction and display of these resources is prohibited. No license is granted to any other TI intellectual property right or to any third party intellectual property right. TI disclaims responsibility for, and you will fully indemnify TI and its representatives against, any claims, damages, costs, losses, and liabilities arising out of your use of these resources.

TI's products are provided subject to [TI's Terms of Sale](#) or other applicable terms available either on [ti.com](https://www.ti.com) or provided in conjunction with such TI products. TI's provision of these resources does not expand or otherwise alter TI's applicable warranties or warranty disclaimers for TI products.

TI objects to and rejects any additional or different terms you may have proposed.

Mailing Address: Texas Instruments, Post Office Box 655303, Dallas, Texas 75265
Copyright © 2024, Texas Instruments Incorporated