

TPS22970 3.6-V, 4-A, 4.7-mΩ On-Resistance Load Switch

1 Features

- Input Voltage Range (V_{IN}): 0.65 V to 3.6 V
- On-Resistance
 - $R_{ON} = 4.7\text{ m}\Omega$ (Typical) at $V_{IN} \geq 1.8\text{ V}$
 - $R_{ON} = 5.1\text{ m}\Omega$ (Typical) at $V_{IN} = 1.05\text{ V}$
 - $R_{ON} = 6.4\text{ m}\Omega$ (Typical) at $V_{IN} = 0.65\text{ V}$
- Maximum Continuous Switch Current (I_{MAX}): 4 A
- ON State (I_Q): 30 μA (Typical) at $V_{IN} > 1.2\text{ V}$
- OFF State (I_{SD}): 1 μA (Typical) at $V_{IN} > 1.8\text{ V}$
- Controlled Slew Rate to Avoid Inrush Current
 - 3.6 V Turn-ON time (t_{ON}): 1530 μs
 - 0.65 V Turn-ON time (t_{ON}): 815 μs
- Low Threshold Enable (ON) Supports Use of Logic as Low as 0.9 V (V_{IH}) of Logic
- Thermal Shutdown (T_{SD})
- Quick Output Discharge (QOD): 150- Ω (Typical)

2 Applications

- Notebook, Tablet
- Industrial PC
- Smartphones
- Telecom
- Storage

3 Description

The TPS22970 is a small, space-saving load switch with controlled Turn-ON to reduce inrush current. The device contains an N-channel MOSFET that can operate over an input voltage range of 0.65 V to 3.6 V and pulsed switch currents up to 4 A. An integrated charge pump biases the NMOS switch in order to achieve a minimum switch ON resistance (R_{ON}). The switch is controlled by an on and off input (ON), which is capable of interfacing directly with low-voltage control signals.

The TPS22970 is capable of thermal shutdown when the junction temperature is above the threshold, turning the switch off. The switch turns on again when the junction temperature stabilizes to a safe range.

The TPS22970 has a 150- Ω on-chip resistor for quick discharge of the output when switch is disabled to avoid any unknown state caused by floating supply to the downstream load.

The TPS22970 has an internally controlled rise time in order to reduce inrush current.

The TPS22970 is available in an ultra-small, space saving 8-pin WCSP package and is characterized for operation over the free-air temperature range of -40°C to $+105^\circ\text{C}$.

Device Information⁽¹⁾

PART NUMBER	PACKAGE	BODY SIZE (NOM)
TPS22970YZPT	DSBGA (8)	1.90 mm x 0.90 mm

(1) For all available packages, see the orderable addendum at the end of the data sheet.

Typical Application

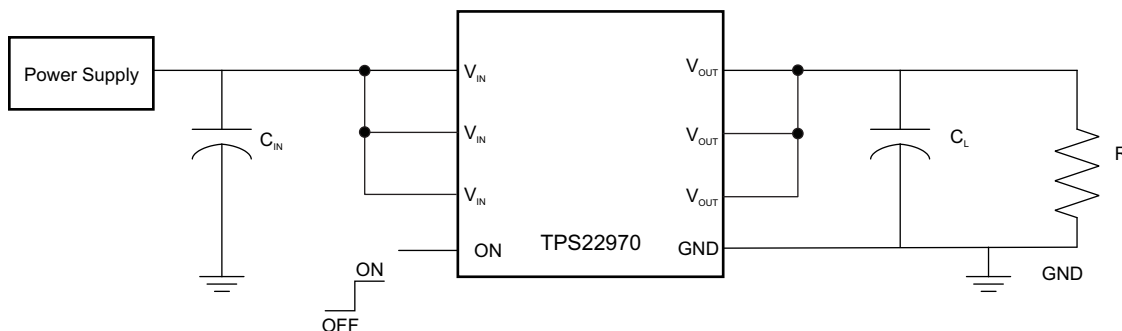

Copyright © 2017, Texas Instruments Incorporated



Table of Contents

1 Features 1 2 Applications 1 3 Description 1 4 Revision History 2 5 Pin Configuration and Functions 3 6 Specifications 4 6.1 Absolute Maximum Ratings 4 6.2 ESD Ratings 4 6.3 Recommended Operating Conditions..... 4 6.4 Thermal Information 4 6.5 Electrical Characteristics..... 5 6.6 Switching Characteristics 6 6.7 Typical DC Characteristics..... 7 6.8 Typical AC Characteristics..... 7 7 Parameter Measurement Information 10 8 Detailed Description 11 8.1 Overview 11 8.2 Functional Block Diagram 11	8.3 Feature Description..... 11 8.4 Device Functional Modes..... 11 9 Application and Implementation 12 9.1 Application Information..... 12 9.2 Typical Application 12 10 Power Supply Recommendations 15 11 Layout 15 11.1 Layout Guidelines 15 11.2 Layout Example 15 12 Device and Documentation Support 16 12.1 Documentation Support 16 12.2 Receiving Notification of Documentation Updates 16 12.3 Community Resources..... 16 12.4 Trademarks 16 12.5 Electrostatic Discharge Caution..... 16 12.6 Glossary 16 13 Mechanical, Packaging, and Orderable Information 17
--	--

4 Revision History

NOTE: Page numbers for previous revisions may differ from page numbers in the current version.

Changes from Original (May 2017) to Revision A	Page
<ul style="list-style-type: none"> • Changed device status from "Advance Information" to " Production Data" 1 	1

5 Pin Configuration and Functions

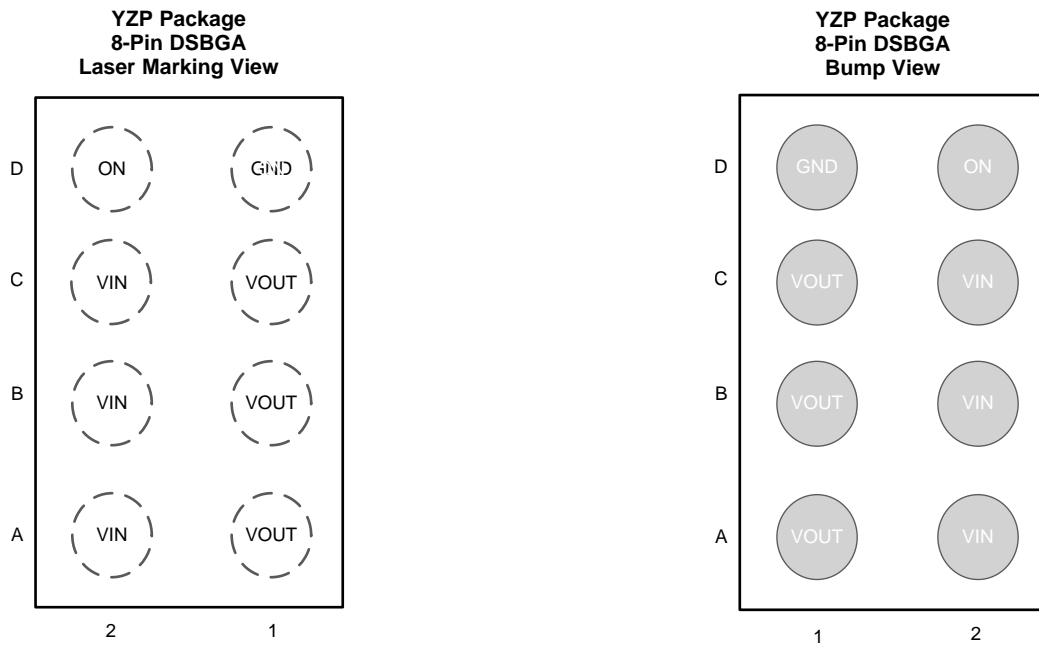

Pin Functions

PIN		TYPE	DESCRIPTION
NAME	NO.		
GND	D1	GND	Ground
ON	D2	I	Switch control input. Do not leave floating
V _{IN}	A2	I	Switch input
	B2		
	C2		
V _{OUT}	A1	O	Switch output
	B1		
	C1		

6 Specifications

6.1 Absolute Maximum Ratings

over operating free-air temperature range (unless otherwise noted)⁽¹⁾

		MIN	MAX	UNIT
V _{IN}	Input voltage	-0.3	4	V
V _{OUT}	Output voltage	-0.3	4	V
V _{ON}	ON voltage	-0.3	4	V
I _{MAX}	Maximum continuous switch current		4	A
I _{PLS}	Maximum pulsed switch current, pulse < 300-μs, 2% duty cycle		6	A
T _J	Maximum junction temperature	Internally Limited		
T _{stg}	Storage temperature	-65	150	°C

(1) Stresses beyond those listed under *Absolute Maximum Ratings* may cause permanent damage to the device. These are stress ratings only, which do not imply functional operation of the device at these or any other conditions beyond those indicated under *Recommended Operating Conditions*. Exposure to absolute-maximum-rated conditions for extended periods may affect device reliability.

6.2 ESD Ratings

		VALUE	UNIT
V _(ESD)	Electrostatic discharge	Human-body model (HBM), per ANSI/ESDA/JEDEC JS-001 ⁽¹⁾	±2000
		Charged-device model (CDM), per JEDEC specification JESD22-C101 ⁽²⁾	±1000

(1) JEDEC document JEP155 states that 500-V HBM allows safe manufacturing with a standard ESD control process.

(2) JEDEC document JEP157 states that 250-V CDM allows safe manufacturing with a standard ESD control process.

6.3 Recommended Operating Conditions

over operating free-air temperature range (unless otherwise noted)

		MIN	MAX	UNIT
V _{IN}	Input voltage	0.65	3.6	V
V _{OUT}	Output voltage		V _{IN}	V
V _{IH}	High-level input voltage, ON	0.9	3.6	V
V _{IL}	Low-level input voltage, ON	0	0.45	V
T _J	Operating temperature	-40	125	°C
T _A	Operating free-air temperature	-40	105	°C

6.4 Thermal Information

THERMAL METRIC ⁽¹⁾		TPS22970	
		YZP (DSBGA)	
		8 PINS	
			UNIT
R _{θJA}	Junction-to-ambient thermal resistance	130	°C/W
R _{θJC(top)}	Junction-to-case (top) thermal resistance	54	°C/W
R _{θJB}	Junction-to-board thermal resistance	51	°C/W
ψ _{JT}	Junction-to-top characterization parameter	1	°C/W
ψ _{JB}	Junction-to-board characterization parameter	50	°C/W

(1) For more information about traditional and new thermal metrics, see the [Semiconductor and IC Package Thermal Metrics](#) application report.

6.5 Electrical Characteristics

Unless otherwise noted, $V_{IN} = 0.65\text{ V}$ to 3.6 V

PARAMETER	TEST CONDITIONS	T_A				UNIT
			MIN	TYP	MAX	
I_Q	Quiescent current $V_{OUT} = \text{Open}$, Switch enabled	$V_{IN} > 1.2\text{ V}$	-40°C to $+85^\circ\text{C}$	30	65	μA
			-40°C to $+105^\circ\text{C}$		75	
		$V_{IN} \leq 1.2\text{ V}$	-40°C to $+85^\circ\text{C}$	20	50	
			-40°C to $+105^\circ\text{C}$		55	
I_{SD}	Shutdown current $V_{OUT} = \text{GND}$, Switch disabled	$V_{IN} > 1.8\text{ V}$	-40°C to $+85^\circ\text{C}$	1	7.5	μA
			-40°C to $+105^\circ\text{C}$		18	
		$V_{IN} \leq 1.8\text{ V}$	-40°C to $+85^\circ\text{C}$	0.9	5	
			-40°C to $+105^\circ\text{C}$		9.5	
R_{ON}	ON-resistance $I_{OUT} = -200\text{ mA}$	$V_{IN} \geq 1.8\text{ V}$	25°C	4.7	8.5	$\text{m}\Omega$
			-40°C to $+85^\circ\text{C}$		9.5	
			-40°C to $+105^\circ\text{C}$		11.5	
		$V_{IN} = 1.2\text{ V}$	25°C	4.9	9.1	
			-40°C to $+85^\circ\text{C}$		10.1	
			-40°C to $+105^\circ\text{C}$		12.1	
		$V_{IN} = 1.05\text{ V}$	25°C	5.1	9.4	
			-40°C to $+85^\circ\text{C}$		10.4	
			-40°C to $+105^\circ\text{C}$		12.4	
		$V_{IN} = 0.65\text{ V}$	25°C	6.4	11.5	
			-40°C to $+85^\circ\text{C}$		12.5	
			-40°C to $+105^\circ\text{C}$		14.5	
R_{PD}	Output pull down resistance ⁽¹⁾	$I_{OUT} = 3\text{ mA}$, Switch disabled	$V_{IN} = 3.6\text{ V}$	-40°C to $+105^\circ\text{C}$	150	Ω
			$V_{IN} = 0.65\text{ V}$	-40°C to $+105^\circ\text{C}$	710	Ω
I_{ON}	ON input leakage current	$V_{ON} = 0\text{ V}$ to 3.6 V	-40°C to $+105^\circ\text{C}$		0.1	μA
T_{SD}	Thermal shutdown	Junction temperature rising			170	$^\circ\text{C}$
$T_{SD, HYS}$	Thermal shutdown hysteresis	Junction temperature falling			30	$^\circ\text{C}$

(1) See the [Quick Output Discharge \(QOD\)](#) section.

6.6 Switching Characteristics

over operating free-air temperature range (unless otherwise noted)

PARAMETER		TEST CONDITIONS	MIN	TYP	MAX	UNIT
V_{IN} = 3.6 V, V_{ON} = 3.6 V, T_A = 25°C (unless otherwise noted)						
t _{ON}	Turn-ON time	C _L = 0.1 μF, R _L = 10 Ω		1530		μs
t _{OFF}	Turn-OFF time	C _L = 0.1 μF, R _L = 10 Ω		3.2		
t _R	VOUT Rise time	C _L = 0.1 μF, R _L = 10 Ω		985		
t _F	VOUT Fall time	C _L = 0.1 μF, R _L = 10 Ω		1.8		
t _D	ON delay time	C _L = 0.1 μF, R _L = 10 Ω		550		
V_{IN} = 1.8 V, V_{ON} = 3.6 V, T_A = 25°C (unless otherwise noted)						
t _{ON}	Turn-ON time	C _L = 0.1 μF, R _L = 10 Ω		1170		μs
t _{OFF}	Turn-OFF time	C _L = 0.1 μF, R _L = 10 Ω		4.9		
t _R	VOUT Rise Time	C _L = 0.1 μF, R _L = 10 Ω		645		
t _F	VOUT Fall time	C _L = 0.1 μF, R _L = 10 Ω		2.2		
t _D	ON delay time	C _L = 0.1 μF, R _L = 10 Ω		525		
V_{IN} = 0.65 V, V_{ON} = 3.6 V, T_A = 25°C (unless otherwise noted)						
t _{ON}	Turn-ON time	C _L = 0.1 μF, R _L = 10 Ω		815		μs
t _{OFF}	Turn-OFF time	C _L = 0.1 μF, R _L = 10 Ω		61		
t _R	VOUT Rise time	C _L = 0.1 μF, R _L = 10 Ω		320		
t _F	VOUT Fall time	C _L = 0.1 μF, R _L = 10 Ω		6.3		
t _D	ON delay time	C _L = 0.1 μF, R _L = 10 Ω		495		

6.7 Typical DC Characteristics

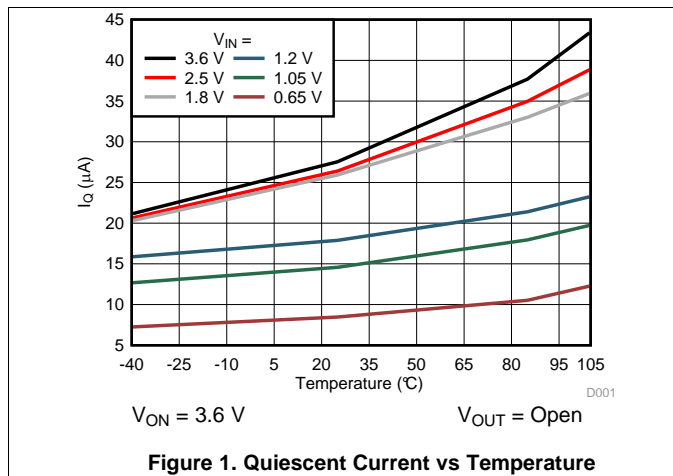

Figure 1. Quiescent Current vs Temperature

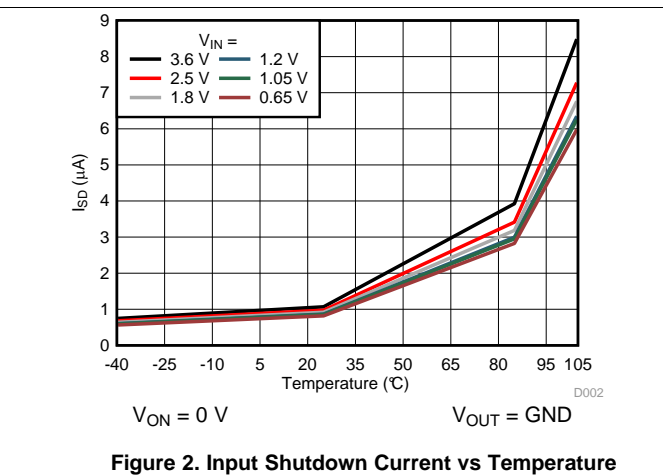

Figure 2. Input Shutdown Current vs Temperature

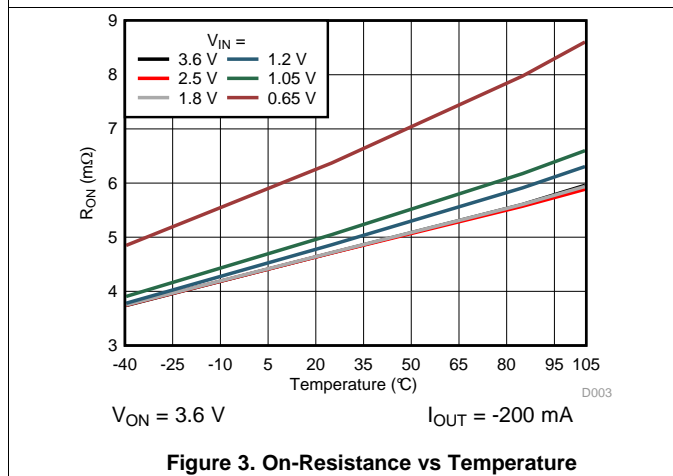

Figure 3. On-Resistance vs Temperature

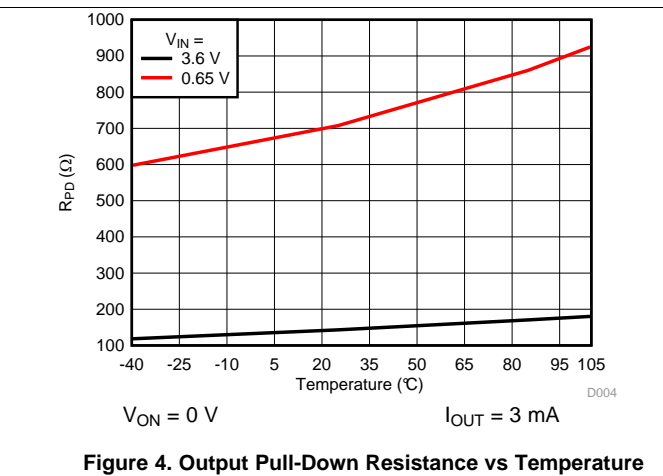

Figure 4. Output Pull-Down Resistance vs Temperature

6.8 Typical AC Characteristics

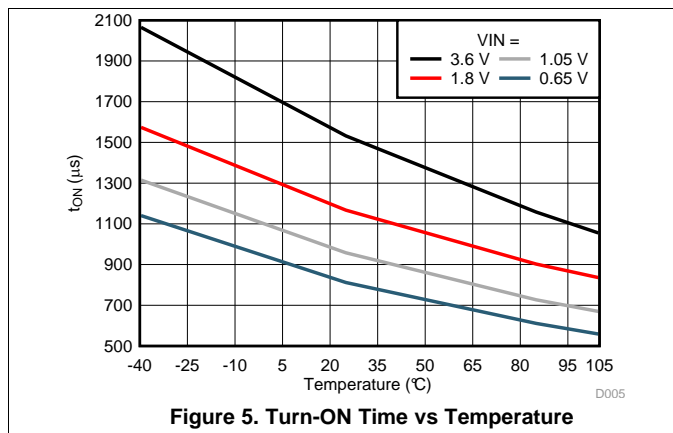

Figure 5. Turn-ON Time vs Temperature

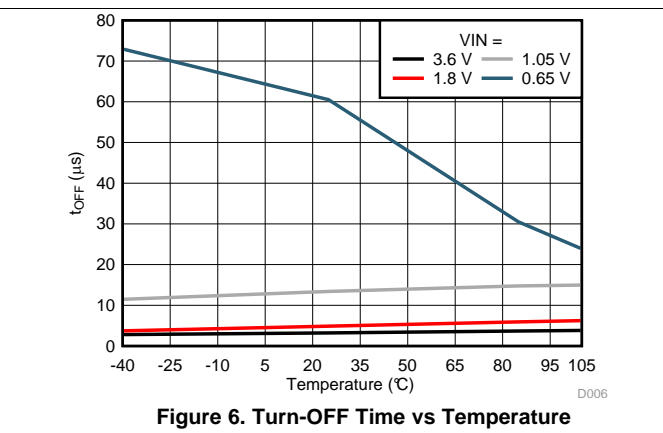

Figure 6. Turn-OFF Time vs Temperature

Typical AC Characteristics (continued)

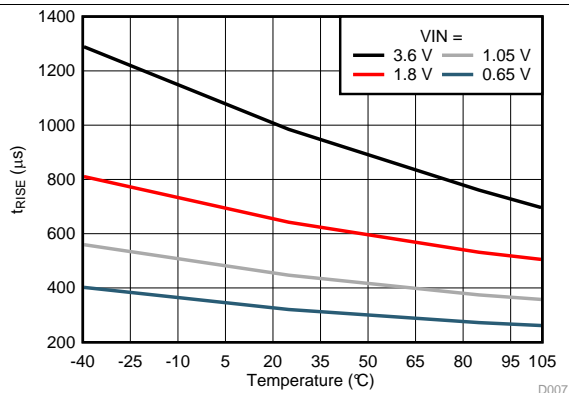

Figure 7. Rise Time vs Temperature

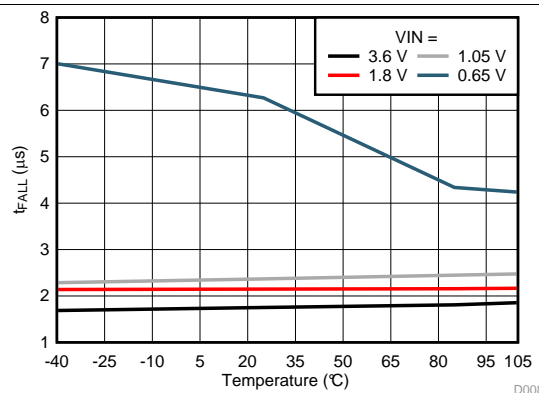

Figure 8. Fall Time vs Temperature

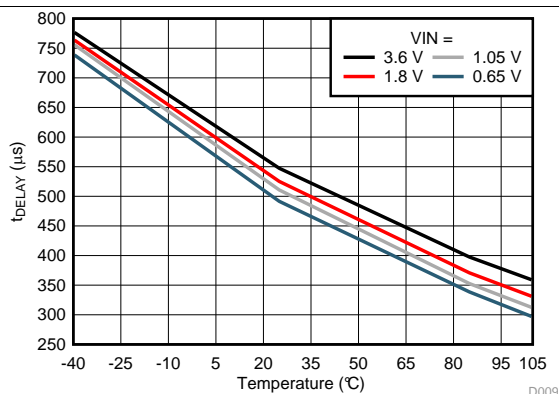

Figure 9. Delay Time vs Temperature

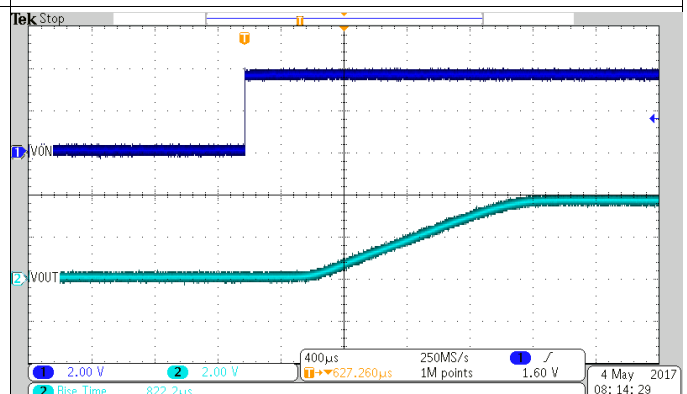

Figure 10. Turn-ON Response at 3.6 VIN

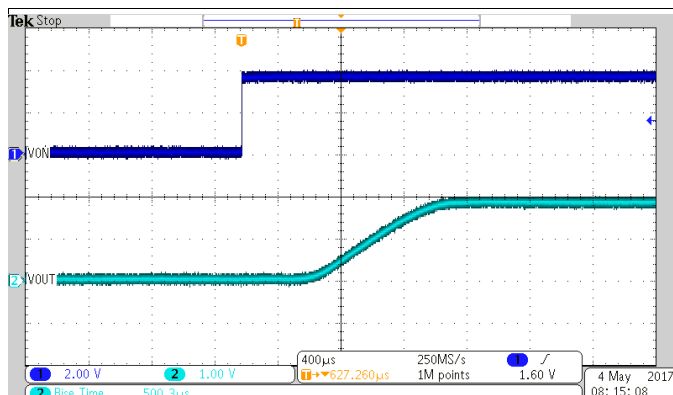

Figure 11. Turn-ON Response at 1.8 VIN

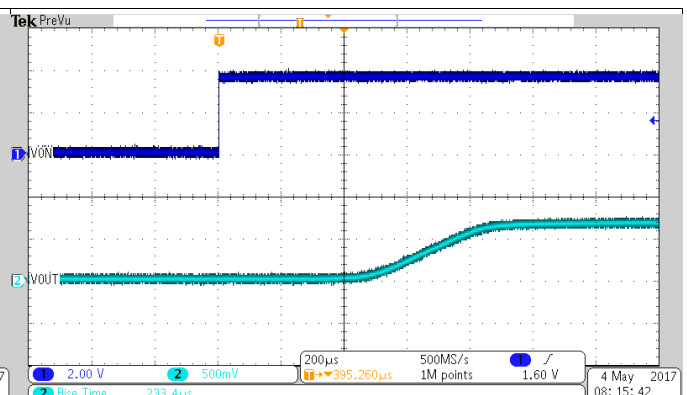
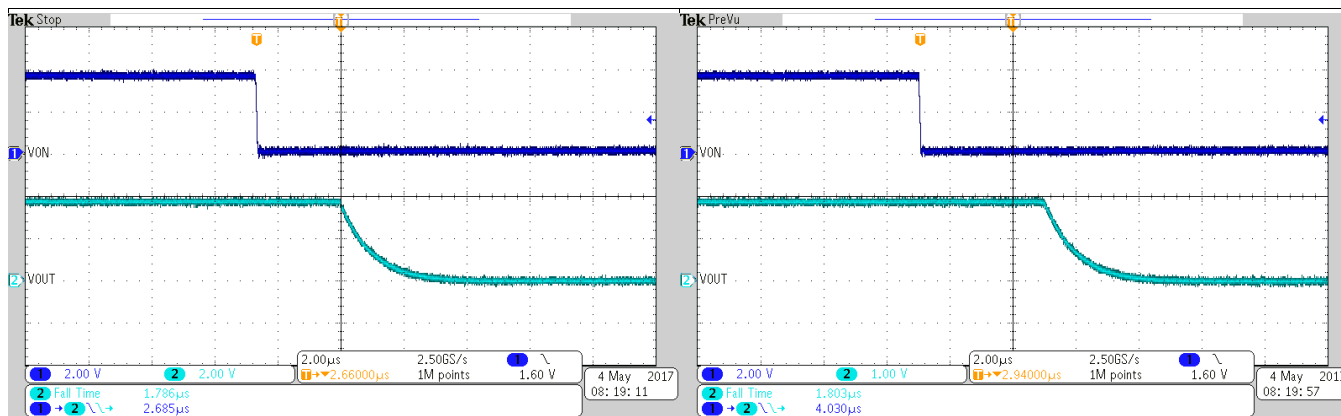

Figure 12. Turn-ON Response at 0.65 VIN

Typical AC Characteristics (continued)



$R_L = 10 \Omega$ $T_A = 25^\circ\text{C}$ $C_L = 0.1 \mu\text{F}$

Figure 13. Turn-OFF Response at 3.6 V_{IN}

$R_L = 10 \Omega$ $T_A = 25^\circ\text{C}$ $C_L = 0.1 \mu\text{F}$

Figure 14. Turn-OFF Response at 1.8 V_{IN}

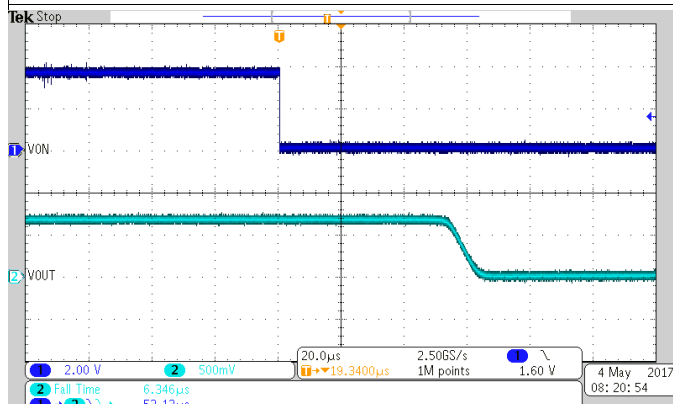

$R_L = 10 \Omega$ $T_A = 25^\circ\text{C}$ $C_L = 0.1 \mu\text{F}$

Figure 15. Turn-OFF Response at 0.65 V_{IN}

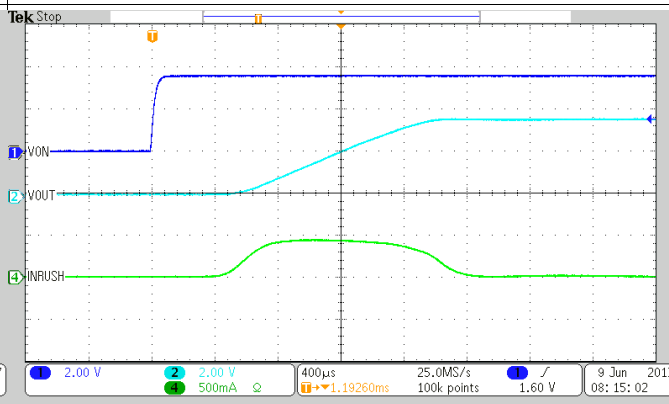

$R_L = \text{OPEN}$ $T_A = 25^\circ\text{C}$ $C_L = 147 \mu\text{F}$

Figure 16. Inrush Current at 3.6 V_{IN}

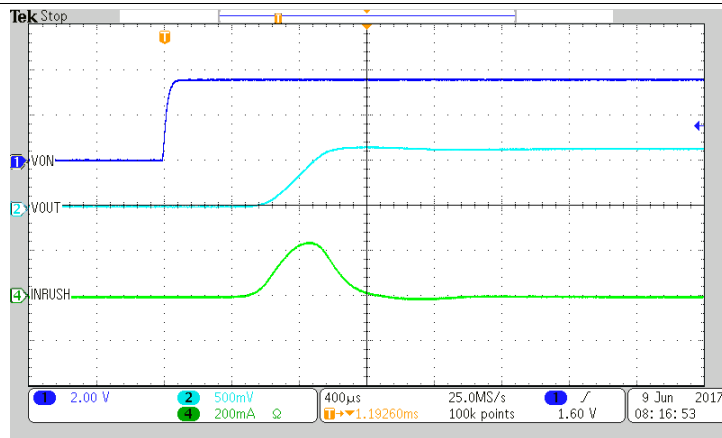

$R_L = \text{OPEN}$

$T_A = 25^\circ\text{C}$

$C_L = 147 \mu\text{F}$

Figure 17. Inrush Current at 0.65 V_{IN}

7 Parameter Measurement Information

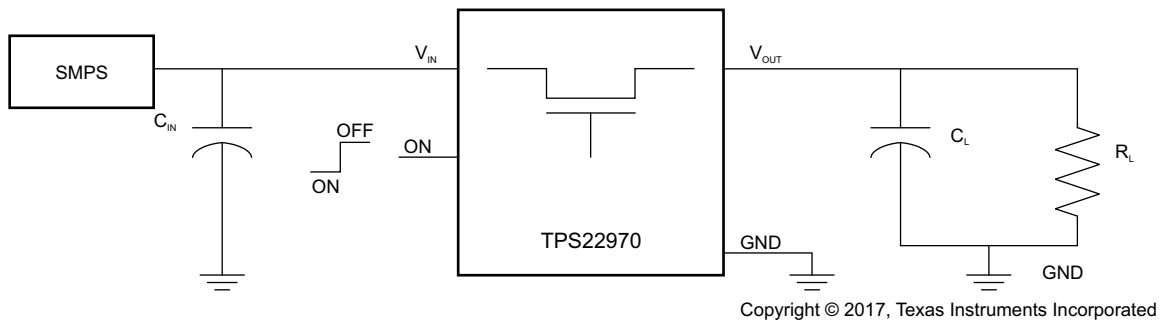

Figure 18. TPS22970 Test Circuit

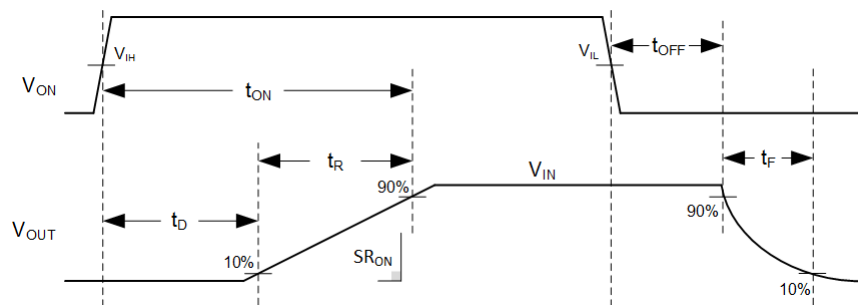

Figure 19. t_{ON} and t_{OFF} Waveforms

8 Detailed Description

8.1 Overview

The TPS22970 is a single channel, 4-A load switch in a small, space-saving WCSP-8 package. This device implements a low resistance N-channel MOSFET with a controlled rise time for applications that need to limit the inrush current.

This device is also designed to have very low leakage current during off state, which prevents downstream circuits from pulling high standby current from the supply. Integrated control logic, driver, power supply, and output discharge FET eliminates the need for additional external components, which reduces solution size and bill of materials (BOM) count.

8.2 Functional Block Diagram

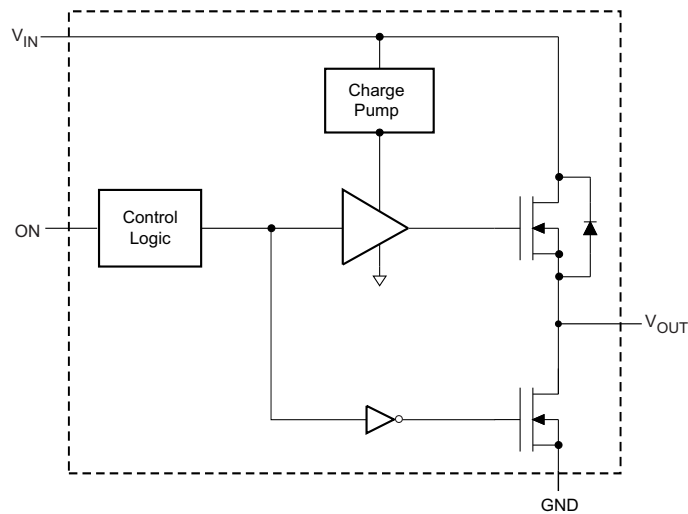

8.3 Feature Description

8.3.1 On and Off Control

The ON pin controls the state of the switch. Asserting ON high enables the switch. ON has a low threshold, making it capable of interfacing with low-voltage signals. The ON pin is compatible with standard GPIO logic. It can be used with any microcontroller with 1.2-V, 1.8-V, 2.5-V or 3.3-V GPIOs. This pin does not have an internal bias and must not be left floating for proper functionality.

8.3.2 Quick Output Discharge (QOD)

The TPS22970 includes a QOD feature. When the switch is disabled, a discharge resistor is connected between V_{OUT} and GND. This resistor has a typical value of 150 Ω and prevents the output from floating while the switch is disabled. The QOD pull-down resistance can vary with input voltage and temperature, see [Figure 4](#)

8.4 Device Functional Modes

[Table 1](#) lists the functional modes for the TPS22970.

Table 1. Function Table

TPS22970		
ON-Pin	V _{IN} to V _{OUT}	V _{OUT} to GND
Below V _{IL}	OFF	ON
Above V _{IH}	ON	OFF

9 Application and Implementation

NOTE

Information in the following applications sections is not part of the TI component specification, and TI does not warrant its accuracy or completeness. TI's customers are responsible for determining suitability of components for their purposes. Customers should validate and test their design implementation to confirm system functionality.

9.1 Application Information

9.1.1 Thermal Consideration

It is recommended to limit the junction temperature (T_J) to below 125°C. To calculate the maximum allowable dissipation, $P_{D(max)}$ for a given output current and ambient temperature, use [Equation 1](#) as a guideline.

$$P_{D(max)} = \frac{T_{J(max)} - T_A}{\theta_{JA}}$$

where

- $P_{D(max)}$ is maximum allowable power dissipation
- $T_{J(max)}$ is maximum allowable junction temperature
- T_A is ambient temperature of the device
- θ_{JA} is junction to air thermal impedance. See the [Thermal Information](#) section. This parameter is highly dependent upon board layout

(1)

9.2 Typical Application

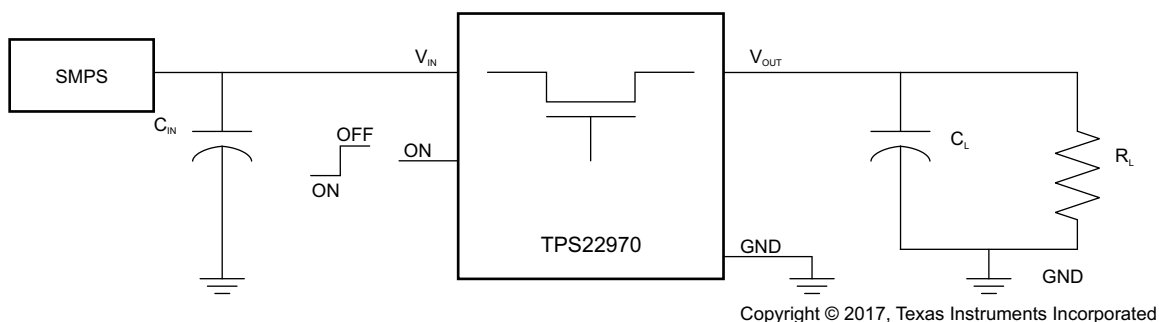

Figure 20. Typical Application Circuit

Typical Application (continued)

9.2.1 Design Requirements

For this design example, below, use the input parameters shown in [Table 2](#).

Table 2. Design Parameters

DESIGN PARAMETER	EXAMPLE VALUE
V_{IN}	0.65 V to 3.6 V
I_{LOAD}	10 mA
Load Capacitance (C_L)	800 μ F
Maximum voltage drop	1%
Maximum Inrush Current	2.5 A

9.2.2 Detailed Design Procedure

9.2.2.1 Maximum Voltage Drop and On-Resistance

At 3.6-V input voltage, with a maximum voltage drop tolerance of 1%, the TPS22970 has a typical R_{ON} of 4.7 m Ω . The rail is supplying 10 mA of current; the voltage drop for a rail is calculated based on [Equation 2](#) and [Equation 3](#).

$$V_{DROP} = R_{ON} \times I_{LOAD} \quad (2)$$

$$V_{DROP} = 0.047 \text{ mV} \quad (3)$$

The maximum voltage drop is 1% which is 36 mV. The voltage drop caused by the load current across the on resistance is 0.047 mV.

9.2.2.2 Managing Inrush Current

When the switch is enabled, the output capacitors must be charged up from 0 V to V_{IN} . This charge arrives in the form of inrush current. Inrush current may be calculated using [Equation 4](#).

$$I_{INRUSH} = C_L \times SR = \frac{C_L \times 0.8 \times V_{IN}}{t_R}$$

where

- I_{INRUSH} is the Inrush current
 - C_L is the Load capacitance
 - SR is the Output Slew Rate
 - V_{IN} is the Input voltage
 - t_R is the Rise time
- (4)

The typical rise time is 985 μ s at $V_{IN} = 3.6$ V. When $C_L = 800$ μ F, the expected inrush current limit at the typical rise time is 2.34 A.

The typical rise time is 320 μ s at $V_{IN} = 0.65$ V. When $C_L = 800$ μ F, the expected inrush current limit at the typical rise time is 1.3 A.

9.2.3 Application Curves

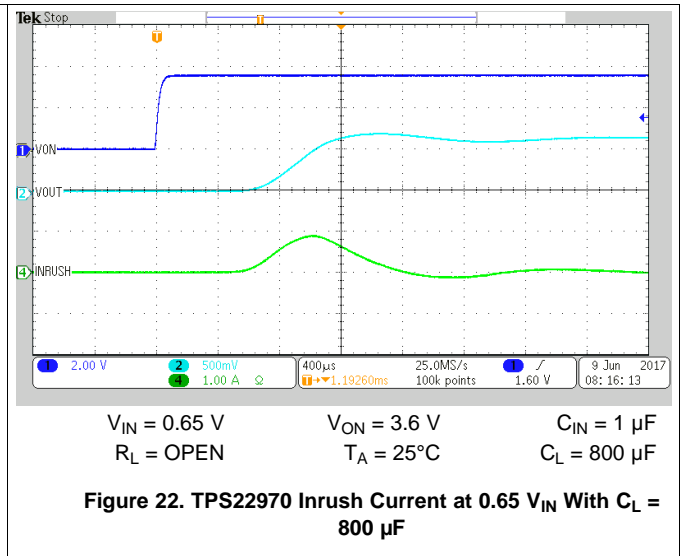
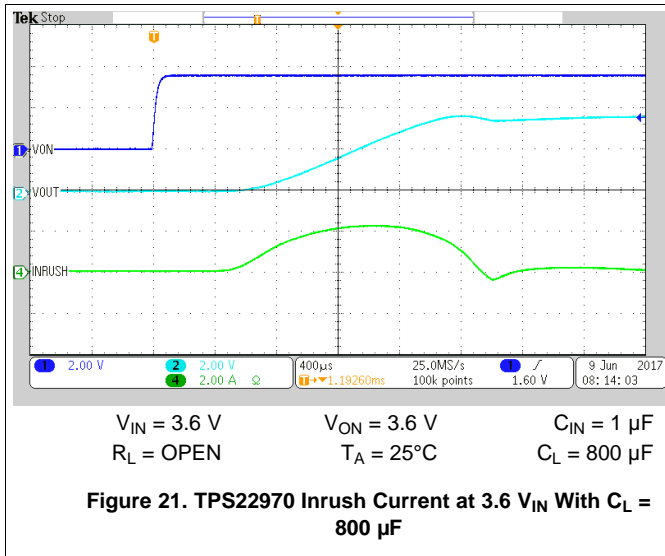

10 Power Supply Recommendations

The device is designed to operate from a V_{IN} range of 0.65 V to 3.6 V. The V_{IN} power supply must be well regulated and placed as close to the device terminal as possible. The power supply must be able to withstand all transient load current steps. In most situations, using an input capacitance of 1 μF is sufficient to prevent the supply voltage from dipping when the switch is turned on. In cases where the power supply is slow to respond to a large transient current or large load current step, additional bulk capacitance may be required on the input.

11 Layout

11.1 Layout Guidelines

All traces must be as short as possible for best performance. Using wide traces for V_{IN} , V_{OUT} , and GND helps minimize the parasitic electrical effects along with minimizing the case to ambient thermal impedance.

11.2 Layout Example

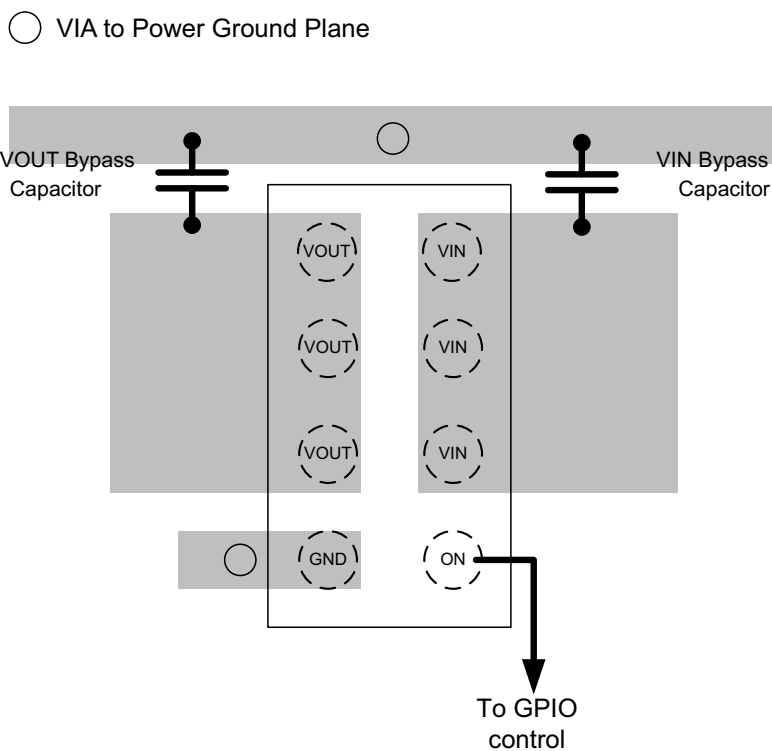

Figure 23. TPS22970 Package Layout

12 Device and Documentation Support

12.1 Documentation Support

12.1.1 Related Documentation

For related documentation see the following:

[TPS22970 Load Switch Evaluation Module](#)

12.2 Receiving Notification of Documentation Updates

To receive notification of documentation updates, navigate to the device product folder on ti.com. In the upper right corner, click on *Alert me* to register and receive a weekly digest of any product information that has changed. For change details, review the revision history included in any revised document.

12.3 Community Resources

The following links connect to TI community resources. Linked contents are provided "AS IS" by the respective contributors. They do not constitute TI specifications and do not necessarily reflect TI's views; see TI's [Terms of Use](#).

TI E2E™ Online Community *TI's Engineer-to-Engineer (E2E) Community*. Created to foster collaboration among engineers. At e2e.ti.com, you can ask questions, share knowledge, explore ideas and help solve problems with fellow engineers.

Design Support *TI's Design Support* Quickly find helpful E2E forums along with design support tools and contact information for technical support.

12.4 Trademarks

E2E is a trademark of Texas Instruments.

NanoFree is a trademark of Nanofree TM.

All other trademarks are the property of their respective owners.

12.5 Electrostatic Discharge Caution



This integrated circuit can be damaged by ESD. Texas Instruments recommends that all integrated circuits be handled with appropriate precautions. Failure to observe proper handling and installation procedures can cause damage.

ESD damage can range from subtle performance degradation to complete device failure. Precision integrated circuits may be more susceptible to damage because very small parametric changes could cause the device not to meet its published specifications.

12.6 Glossary

[SLYZ022](#) — *TI Glossary*.

This glossary lists and explains terms, acronyms, and definitions.

13 Mechanical, Packaging, and Orderable Information

The following pages include mechanical, packaging, and orderable information. This information is the most current data available for the designated devices. This data is subject to change without notice and revision of this document. For browser-based versions of this data sheet, refer to the left-hand navigation.

YZP (R–XBGA–N8)

DIE–SIZE BALL GRID ARRAY

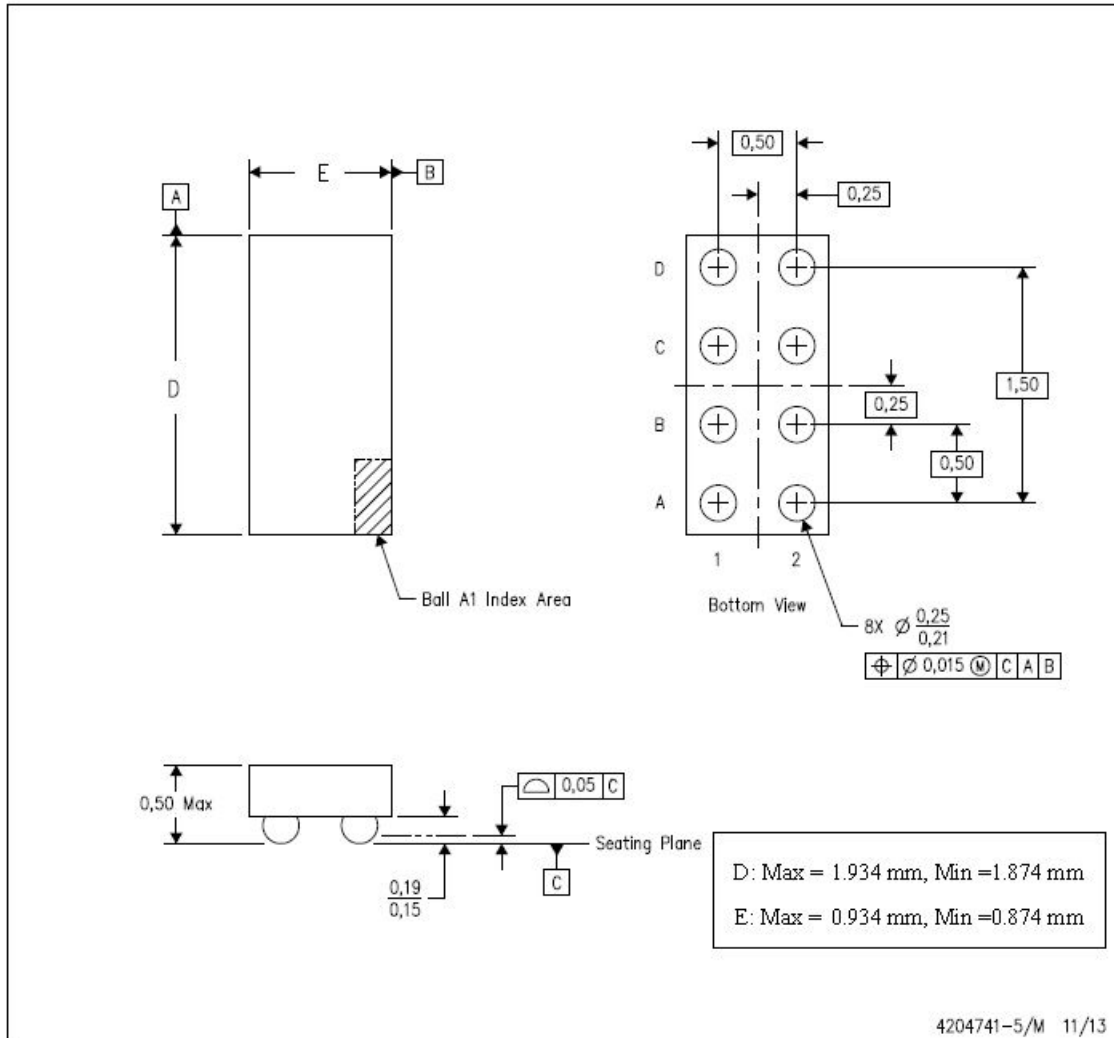

- (1) All linear dimensions are in millimeters. Dimensioning and tolerancing per ASME Y14.5M-1994.
- (2) This drawing is subject to change without notice.
- (3) NanoFree™ package configuration.

PACKAGING INFORMATION

Orderable Device	Status (1)	Package Type	Package Drawing	Pins	Package Qty	Eco Plan (2)	Lead finish/ Ball material (6)	MSL Peak Temp (3)	Op Temp (°C)	Device Marking (4/5)	Samples
TPS22970YZPR	ACTIVE	DSBGA	YZP	8	3000	RoHS & Green	SAC396	Level-1-260C-UNLIM	-40 to 105	1CNI	Samples
TPS22970YZPT	ACTIVE	DSBGA	YZP	8	250	RoHS & Green	SAC396	Level-1-260C-UNLIM	-40 to 105	1CNI	Samples

(1) The marketing status values are defined as follows:

ACTIVE: Product device recommended for new designs.

LIFEBUY: TI has announced that the device will be discontinued, and a lifetime-buy period is in effect.

NRND: Not recommended for new designs. Device is in production to support existing customers, but TI does not recommend using this part in a new design.

PREVIEW: Device has been announced but is not in production. Samples may or may not be available.

OBSOLETE: TI has discontinued the production of the device.

(2) **RoHS:** TI defines "RoHS" to mean semiconductor products that are compliant with the current EU RoHS requirements for all 10 RoHS substances, including the requirement that RoHS substance do not exceed 0.1% by weight in homogeneous materials. Where designed to be soldered at high temperatures, "RoHS" products are suitable for use in specified lead-free processes. TI may reference these types of products as "Pb-Free".

RoHS Exempt: TI defines "RoHS Exempt" to mean products that contain lead but are compliant with EU RoHS pursuant to a specific EU RoHS exemption.

Green: TI defines "Green" to mean the content of Chlorine (Cl) and Bromine (Br) based flame retardants meet JS709B low halogen requirements of <=1000ppm threshold. Antimony trioxide based flame retardants must also meet the <=1000ppm threshold requirement.

(3) MSL, Peak Temp. - The Moisture Sensitivity Level rating according to the JEDEC industry standard classifications, and peak solder temperature.

(4) There may be additional marking, which relates to the logo, the lot trace code information, or the environmental category on the device.

(5) Multiple Device Markings will be inside parentheses. Only one Device Marking contained in parentheses and separated by a "~" will appear on a device. If a line is indented then it is a continuation of the previous line and the two combined represent the entire Device Marking for that device.

(6) Lead finish/Ball material - Orderable Devices may have multiple material finish options. Finish options are separated by a vertical ruled line. Lead finish/Ball material values may wrap to two lines if the finish value exceeds the maximum column width.

Important Information and Disclaimer:The information provided on this page represents TI's knowledge and belief as of the date that it is provided. TI bases its knowledge and belief on information provided by third parties, and makes no representation or warranty as to the accuracy of such information. Efforts are underway to better integrate information from third parties. TI has taken and continues to take reasonable steps to provide representative and accurate information but may not have conducted destructive testing or chemical analysis on incoming materials and chemicals. TI and TI suppliers consider certain information to be proprietary, and thus CAS numbers and other limited information may not be available for release.

In no event shall TI's liability arising out of such information exceed the total purchase price of the TI part(s) at issue in this document sold by TI to Customer on an annual basis.

TAPE AND REEL INFORMATION

QUADRANT ASSIGNMENTS FOR PIN 1 ORIENTATION IN TAPE

*All dimensions are nominal

Device	Package Type	Package Drawing	Pins	SPQ	Reel Diameter (mm)	Reel Width W1 (mm)	A0 (mm)	B0 (mm)	K0 (mm)	P1 (mm)	W (mm)	Pin1 Quadrant
TPS22970YZPR	DSBGA	YZP	8	3000	180.0	8.4	1.02	2.02	0.63	2.0	8.0	Q1
TPS22970YZPT	DSBGA	YZP	8	250	180.0	8.4	1.02	2.02	0.63	2.0	8.0	Q1

TAPE AND REEL BOX DIMENSIONS

*All dimensions are nominal

Device	Package Type	Package Drawing	Pins	SPQ	Length (mm)	Width (mm)	Height (mm)
TPS22970YZPR	DSBGA	YZP	8	3000	182.0	182.0	20.0
TPS22970YZPT	DSBGA	YZP	8	250	182.0	182.0	20.0

YZP0008

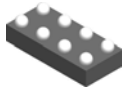

PACKAGE OUTLINE

DSBGA - 0.5 mm max height

DIE SIZE BALL GRID ARRAY

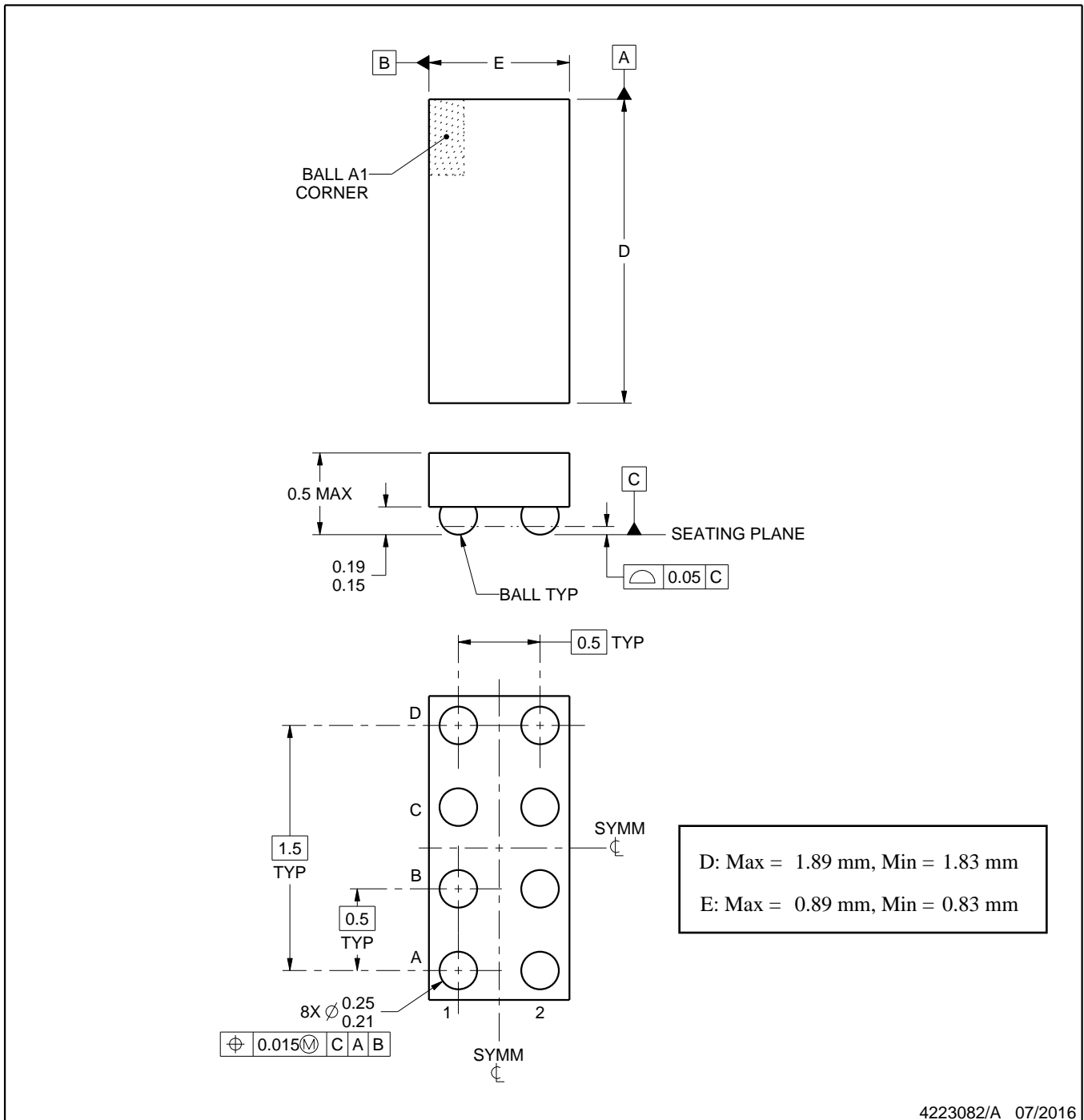

4223082/A 07/2016

NOTES:

1. All linear dimensions are in millimeters. Any dimensions in parenthesis are for reference only. Dimensioning and tolerancing per ASME Y14.5M.
2. This drawing is subject to change without notice.

EXAMPLE BOARD LAYOUT

YZP0008

DSBGA - 0.5 mm max height

DIE SIZE BALL GRID ARRAY



LAND PATTERN EXAMPLE
SCALE:40X



SOLDER MASK DETAILS
NOT TO SCALE

4223082/A 07/2016

NOTES: (continued)

- Final dimensions may vary due to manufacturing tolerance considerations and also routing constraints. For more information, see Texas Instruments literature number SNVA009 (www.ti.com/lit/snva009).

EXAMPLE STENCIL DESIGN

YZP0008

DSBGA - 0.5 mm max height

DIE SIZE BALL GRID ARRAY



SOLDER PASTE EXAMPLE
BASED ON 0.1 mm THICK STENCIL
SCALE:40X

4223082/A 07/2016

NOTES: (continued)

4. Laser cutting apertures with trapezoidal walls and rounded corners may offer better paste release.

IMPORTANT NOTICE AND DISCLAIMER

TI PROVIDES TECHNICAL AND RELIABILITY DATA (INCLUDING DATA SHEETS), DESIGN RESOURCES (INCLUDING REFERENCE DESIGNS), APPLICATION OR OTHER DESIGN ADVICE, WEB TOOLS, SAFETY INFORMATION, AND OTHER RESOURCES "AS IS" AND WITH ALL FAULTS, AND DISCLAIMS ALL WARRANTIES, EXPRESS AND IMPLIED, INCLUDING WITHOUT LIMITATION ANY IMPLIED WARRANTIES OF MERCHANTABILITY, FITNESS FOR A PARTICULAR PURPOSE OR NON-INFRINGEMENT OF THIRD PARTY INTELLECTUAL PROPERTY RIGHTS.

These resources are intended for skilled developers designing with TI products. You are solely responsible for (1) selecting the appropriate TI products for your application, (2) designing, validating and testing your application, and (3) ensuring your application meets applicable standards, and any other safety, security, regulatory or other requirements.

These resources are subject to change without notice. TI grants you permission to use these resources only for development of an application that uses the TI products described in the resource. Other reproduction and display of these resources is prohibited. No license is granted to any other TI intellectual property right or to any third party intellectual property right. TI disclaims responsibility for, and you will fully indemnify TI and its representatives against, any claims, damages, costs, losses, and liabilities arising out of your use of these resources.

TI's products are provided subject to [TI's Terms of Sale](#) or other applicable terms available either on [ti.com](https://www.ti.com) or provided in conjunction with such TI products. TI's provision of these resources does not expand or otherwise alter TI's applicable warranties or warranty disclaimers for TI products.

TI objects to and rejects any additional or different terms you may have proposed.

Mailing Address: Texas Instruments, Post Office Box 655303, Dallas, Texas 75265
Copyright © 2023, Texas Instruments Incorporated