

# VOLTAGE DETECTOR

## FEATURES

- **Controlled Baseline**
  - One Assembly/Test Site, One Fabrication Site
- **Extended Temperature Performance of Up to  $-55^{\circ}\text{C}$  to  $+125^{\circ}\text{C}$**
- **Enhanced Diminishing Manufacturing Sources (DMS) Support**
- **Enhanced Product-Change Notification**
- **Qualification Pedigree<sup>(1)</sup>**
- **Single Voltage Detector (TPS3803): Adjustable/1.5 V**
- **Dual Voltage Detector (TPS3805): Adjustable/3.3 V**
- **High  $\pm 1.5\%$  Threshold Voltage Accuracy**
- **Supply Current: 3  $\mu\text{A}$  Typical at  $V_{\text{DD}} = 3.3 \text{ V}$**
- **Push/Pull Reset Output (TPS3805) Open-Drain Reset Output (TPS3803)**
- **5-Pin SC-70 Package**

(1) Component qualification in accordance with JEDEC and industry standards to ensure reliable operation over an extended temperature range. This includes, but is not limited to, Highly Accelerated Stress Test (HAST) or biased 85/85, temperature cycle, autoclave or unbiased HAST, electromigration, bond intermetallic life, and mold compound life. Such qualification testing should not be viewed as justifying use of this component beyond specified performance and environmental limits.

## APPLICATIONS

- **Applications Using DSPs, Microcontrollers, or Microprocessors**
- **Wireless Communication Systems**
- **Portable/Battery-Powered Equipment**
- **Programmable Controls**
- **Intelligent Instruments**
- **Industrial Equipment**
- **Notebook/Desktop Computers**
- **Automotive Systems**

## DESCRIPTION

The TPS3803 and TPS3805 families of supervisory circuits provide circuit initialization and timing supervision, primarily for DSPs and processor-based systems.

The TPS3803G15 device has a fixed-sense threshold voltage  $V_{\text{IT}}$  set by an internal voltage divider, whereas the TPS3803-01 has an adjustable SENSE input that can be configured by two external resistors. In addition to the fixed sense threshold monitored at  $V_{\text{DD}}$ , the TPS3805 devices provide a second adjustable SENSE input.  $\overline{\text{RESET}}$  is asserted in case any of the two voltages drops below  $V_{\text{IT}}$ .

During power on,  $\overline{\text{RESET}}$  is asserted when supply voltage  $V_{\text{DD}}$  becomes higher than 0.8 V. Thereafter, the supervisory circuit monitors  $V_{\text{DD}}$  (and/or SENSE) and keeps  $\overline{\text{RESET}}$  active as long as  $V_{\text{DD}}$  or SENSE remains below the threshold voltage  $V_{\text{IT}}$ . As soon as  $V_{\text{DD}}$  (SENSE) rises above the threshold voltage  $V_{\text{IT}}$ ,  $\overline{\text{RESET}}$  is deasserted again. The product spectrum is designed for 1.5 V, 3.3 V, and adjustable supply voltages. The devices are available in a 5-pin SC-70 package.

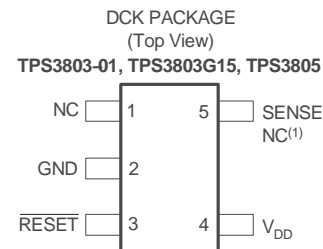

(1) NC = No Connection on TPS3803G15

## Typical Operating Circuit

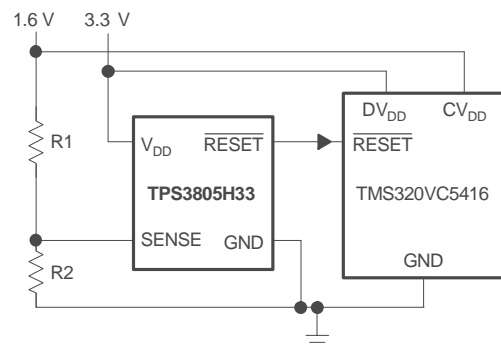

Please be aware that an important notice concerning availability, standard warranty, and use in critical applications of Texas Instruments semiconductor products and disclaimers thereto appears at the end of this data sheet.

All trademarks are the property of their respective owners.



This integrated circuit can be damaged by ESD. Texas Instruments recommends that all integrated circuits be handled with appropriate precautions. Failure to observe proper handling and installation procedures can cause damage.

ESD damage can range from subtle performance degradation to complete device failure. Precision integrated circuits may be more susceptible to damage because very small parametric changes could cause the device not to meet its published specifications.

**PACKAGE INFORMATION**

T <sub>A</sub>	DEVICE NAME	THRESHOLD VOLTAGE		MARKING
		V <sub>DD</sub>	SENSE	
-40°C to +125°C	TPS3803-01QDCKREP(2)	NA	1.226 V	AWH
	TPS3803G15QDCKREP(2)	1.4 V	NA	AXT
	TPS3805H33QDCKREP(2)	3.05 V	1.226 V	AWY
-55°C to +125°C	TPS3803-01MDCKREP(2)	NA	1.226 V	BAY
	TPS3803G15MDCKREP(2)	1.40 V	NA	ARH
	TPS3805H33MDCKREP(2)	3.05 V	1.226 V	ARJ

(2) The DCKR passive indicates tape and reel containing 3000 parts.

**ORDERING INFORMATION**

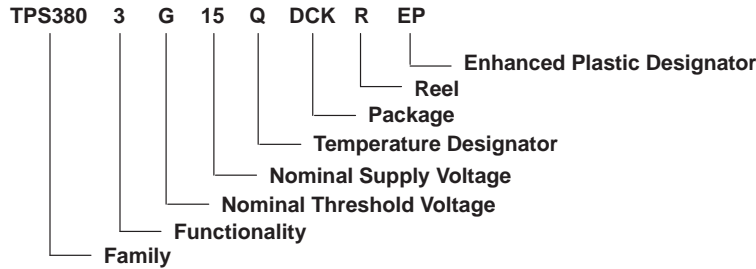

**Function/Truth Tables**

TPS3803-01		TPS3803G15	
SENSE > V <sub>IT</sub>	RESET	V <sub>DD</sub> > V <sub>IT</sub>	RESET
0	L	0	L
1	H	1	H

TPS3805H33		
V <sub>DD</sub> > V <sub>IT</sub>	SENSE > V <sub>IT</sub>	RESET
0	0	L
0	1	L
1	0	L
1	1	H

**FUNCTIONAL BLOCK DIAGRAM**

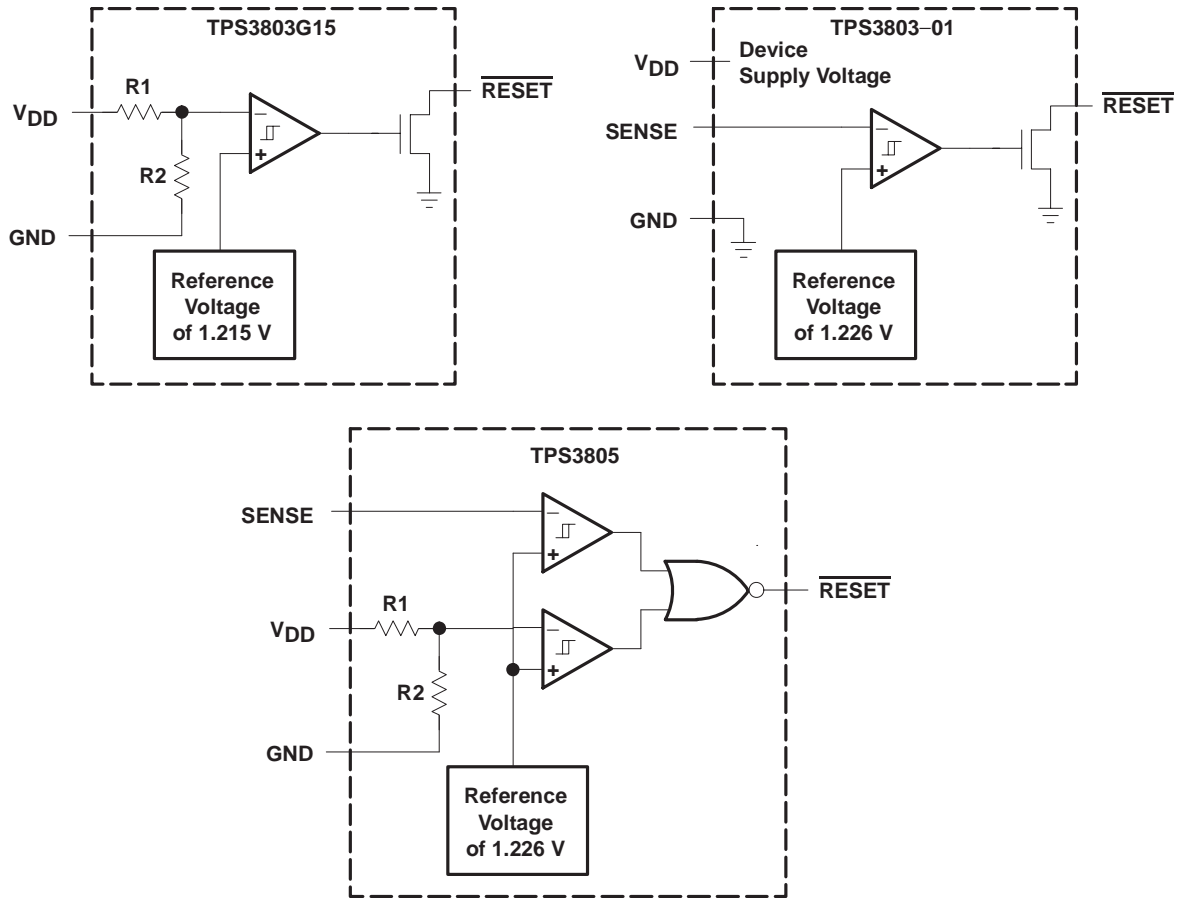

**TIMING REQUIREMENTS**

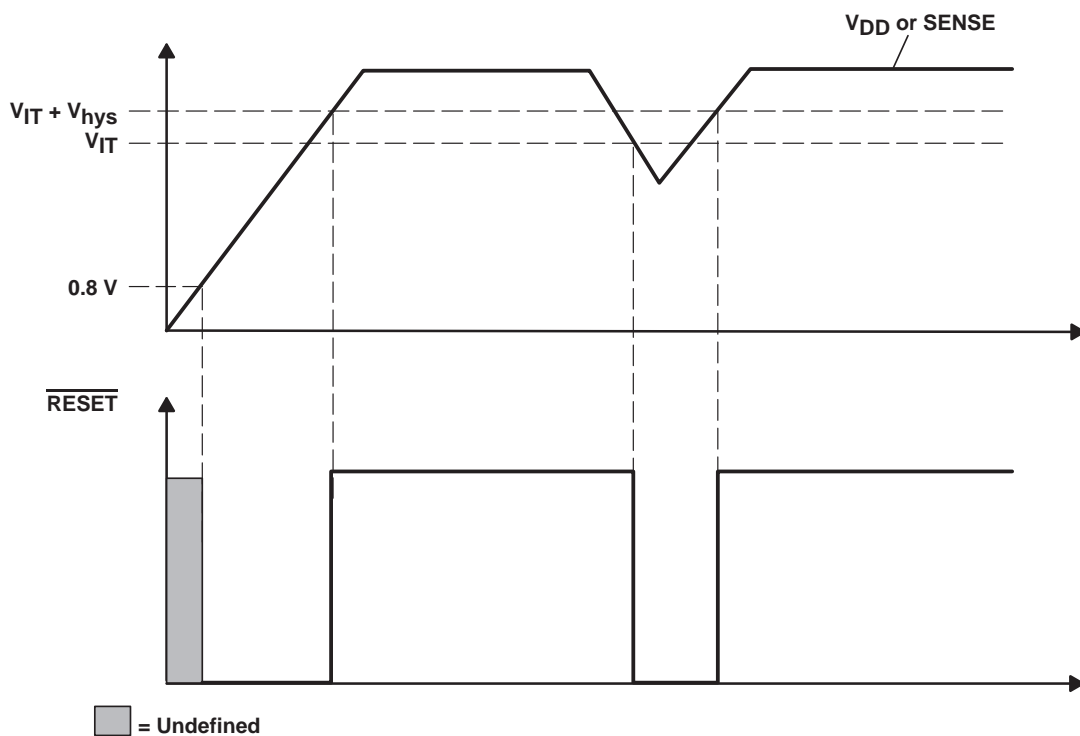

**Terminal Functions**

TERMINAL NAME	NO.	I/O	DESCRIPTION
GND	2	I	Ground
RESET	3	O	Active-low reset output (TPS3803—open-drain, TPS3805—push/pull)
SENSE	5	I	Adjustable sense input
NC	1		No internal connection
NC (TPS3803G15)	5		No internal connection
V <sub>DD</sub>	4	I	Input supply voltage, fixed sense input for TPS3803G15 and TPS3805

## ABSOLUTE MAXIMUM RATINGS<sup>(1)</sup>

Over operating free-air temperature, unless otherwise noted.

Supply voltage, $V_{DD}$ <sup>(2)</sup> .....	+7 V
All other pins <sup>(2)</sup> .....	-0.3 V to +7 V
Maximum low-output current, $I_{OL}$ .....	+5 mA
Maximum high-output current, $I_{OH}$ .....	-5 mA
Input clamp current, $I_{IK}$ ( $V_I < 0$ or $V_I > V_{DD}$ ) .....	$\pm 10$ mA
Output clamp current, $I_{OK}$ ( $V_O < 0$ or $V_O > V_{DD}$ ) .....	$\pm 10$ mA
Continuous total power dissipation .....	See Dissipation Rating Table
Operating free-air temperature range, $T_A$ .....	-55°C to +125°C
Storage temperature range, $T_{stg}$ <sup>(3)</sup> .....	-65°C to +150°C

(1) Stresses beyond those listed under “absolute maximum ratings” may cause permanent damage to the device. These are stress ratings only, and functional operation of the device at these or any other conditions beyond those indicated under “recommended operating conditions” is not implied. Exposure to absolute-maximum-rated conditions for extended periods may affect device reliability.

(2) All voltage values are with respect to GND. For reliable operation the device should not be continuously operated at 7 V for more than  $t = 1000$  h.

(3) Long-term high-temperature storage and/or extended use at maximum recommended operating conditions may result in a reduction of overall device life. See [www.ti.com/ep\\_quality](http://www.ti.com/ep_quality) for additional information on enhanced plastic packaging.

DISSIPATION RATING TABLE

PACKAGE	$T_A < +25^\circ\text{C}$ POWER RATING	DERATING FACTOR ABOVE $T_A = +25^\circ\text{C}$	$T_A = +70^\circ\text{C}$ POWER RATING	$T_A = +85^\circ\text{C}$ POWER RATING
DCK	321 mW	2.6 mW/°C	206 mW	167 mW

## RECOMMENDED OPERATING CONDITIONS

		MIN	MAX	UNIT
Supply voltage, $V_{DD}$		1.3	6	V
Input voltage, $V_I$		0	$V_{DD} + 0.3$	V
Operating free-air temperature range, $T_A$	Q suffix devices	-40	+125	°C
	M suffix devices	-55	+125	

## ELECTRICAL CHARACTERISTICS

Over recommended operating free-air temperature range, unless otherwise noted.

PARAMETER		TEST CONDITIONS	MIN	TYP	MAX	UNIT
V <sub>OH</sub>	High-level output voltage (TPS3805 only)	V <sub>DD</sub> = 1.5 V, I <sub>OH</sub> = -0.5 mA	0.8 x V <sub>DD</sub>			V
		V <sub>DD</sub> = 3.3 V, I <sub>OH</sub> = -1 mA				
		V <sub>DD</sub> = 6 V, I <sub>OH</sub> = -1.5 mA				
V <sub>OL</sub>	Low-level output voltage	V <sub>DD</sub> = 1.5 V, I <sub>OL</sub> = 1 mA			0.3	V
		V <sub>DD</sub> = 3.3 V, I <sub>OL</sub> = 2 mA				
		V <sub>DD</sub> = 6 V, I <sub>OL</sub> = 3 mA				
Power-up reset voltage(1)		V <sub>IT</sub> > 1.5 V, T <sub>A</sub> = +25°C	0.8			V
		V <sub>IT</sub> ≤ 1.5 V, T <sub>A</sub> = +25°C	1			V
V <sub>IT</sub>	Negative-going input threshold voltage(2)	SENSE	1.2	1.226	1.244	V
		TPS3803G15	1.379	1.4	1.421	
		TPS3805H33	3.004	3.05	3.096	
V <sub>hys</sub>	Hysteresis	1.2 V < V <sub>IT</sub> < 2.5 V	15		mV	
		2.5 V < V <sub>IT</sub> < 3.5 V	30			
I <sub>I</sub>	Input current	SENSE	-25		25	nA
I <sub>OH</sub>	High-level output current at $\overline{\text{RESET}}$	Open-drain only	V <sub>DD</sub> = V <sub>IT</sub> + 0.2V, V <sub>OH</sub> = V <sub>DD</sub>		300	nA
I <sub>DD</sub>	Supply current	TPS3803-01	V <sub>DD</sub> = 3.3 V, output unconnected	2	4	μA
		TPS3805, TPS3803G15		3	5	
		TPS3803-01	V <sub>DD</sub> = 6 V, output unconnected	2	4	
		TPS3805, TPS3803G15		4	6	
C <sub>I</sub>	Input capacitance	V <sub>I</sub> = 0 V to V <sub>DD</sub>	1			pF

(1) The lowest supply voltage at which  $\overline{\text{RESET}}$  (V<sub>OL(max)</sub> = 0.2 V, I<sub>OL</sub> = 50 μA) becomes active. t<sub>r</sub>(V<sub>DD</sub>) ≥ 15 μs/V

(2) To ensure the best stability of the threshold voltage, place a bypass capacitor (ceramic, 0.1 μF) near the supply terminals.

## TIMING REQUIREMENTS

AT R<sub>L</sub> = 1 MΩ, C<sub>L</sub> = 50 PF, over recommended operating free-air temperature range.

PARAMETER		TEST CONDITIONS	MIN	TYP	MAX	UNIT
t <sub>w</sub>	At V <sub>DD</sub>	V <sub>IH</sub> = 1.05 x V <sub>IT</sub> , V <sub>IL</sub> = 0.95 x V <sub>IT</sub>	5.5			μs
	At SENSE					

## SWITCHING CHARACTERISTICS

AT R<sub>L</sub> = 1 MΩ, C<sub>L</sub> = 50 PF, over recommended operating free-air temperature range.

PARAMETER		TEST CONDITIONS	MIN	TYP	MAX	UNIT
t <sub>PHL</sub>	Propagation (delay) time, high-to-low-level output	V <sub>DD</sub> to $\overline{\text{RESET}}$ delay	V <sub>IH</sub> = 1.05 x V <sub>IT</sub> , V <sub>IL</sub> = 0.95 x V <sub>IT</sub>	5	100	μs
		SENSE to $\overline{\text{RESET}}$ delay				
t <sub>PLH</sub>	Propagation (delay) time, low-to-high-level output	V <sub>DD</sub> to $\overline{\text{RESET}}$ delay		5	100	
		SENSE to $\overline{\text{RESET}}$ delay				

TYPICAL CHARACTERISTICS

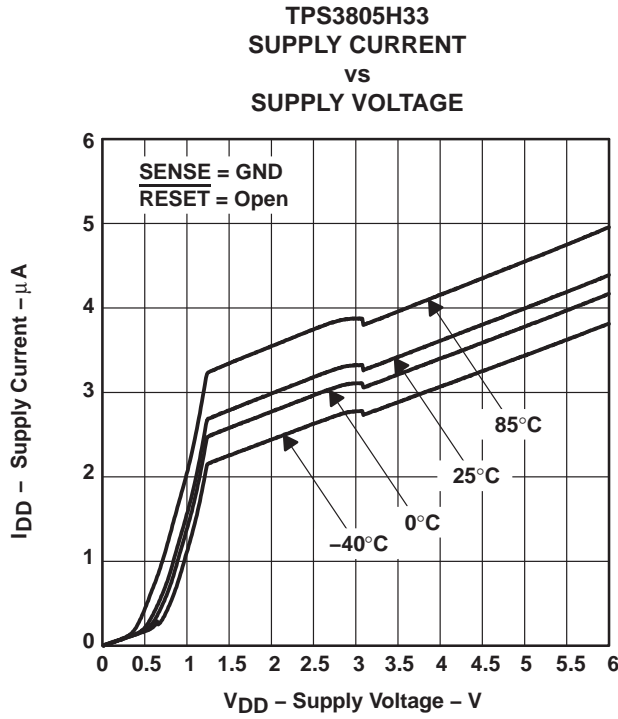

Figure 1

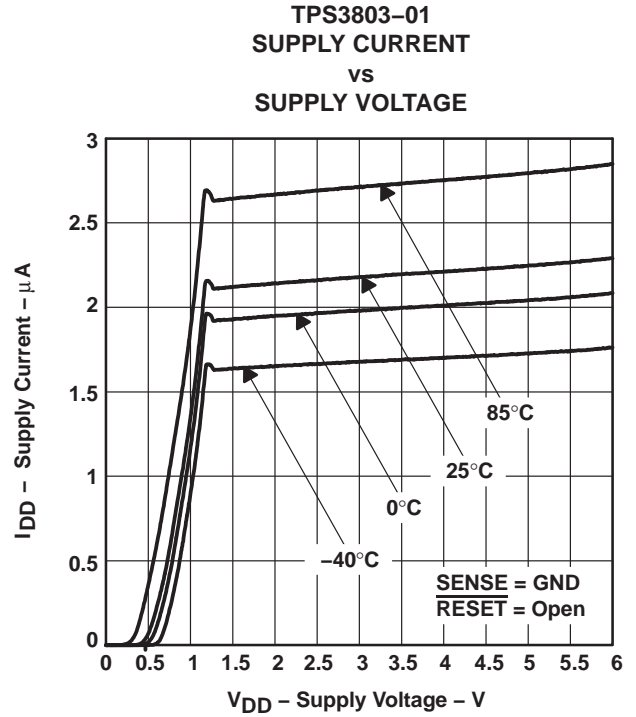

Figure 2

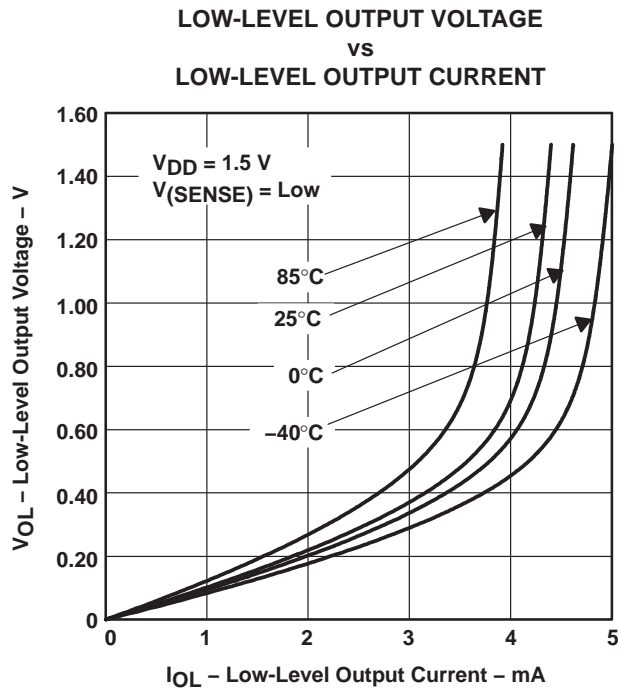

Figure 3

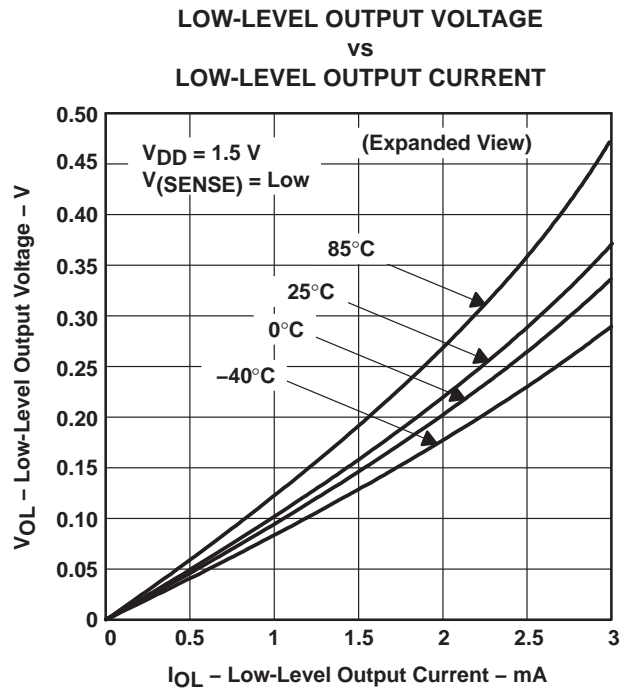

Figure 4

TYPICAL CHARACTERISTICS

LOW-LEVEL OUTPUT VOLTAGE  
 vs  
 LOW-LEVEL OUTPUT CURRENT

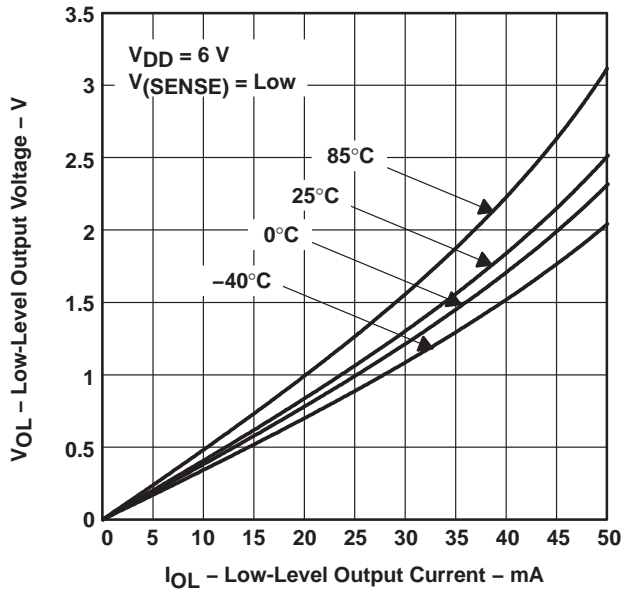

Figure 5

LOW-LEVEL OUTPUT VOLTAGE  
 vs  
 LOW-LEVEL OUTPUT CURRENT

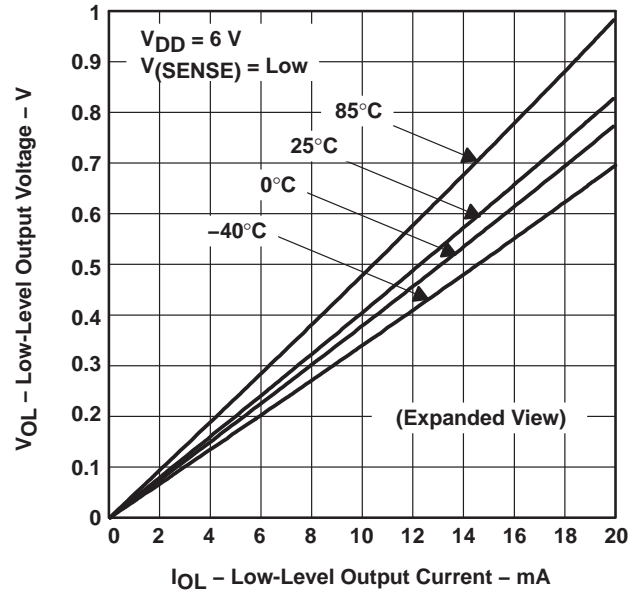

Figure 6

TPS3805H33  
 HIGH-LEVEL OUTPUT VOLTAGE  
 vs  
 HIGH-LEVEL OUTPUT CURRENT

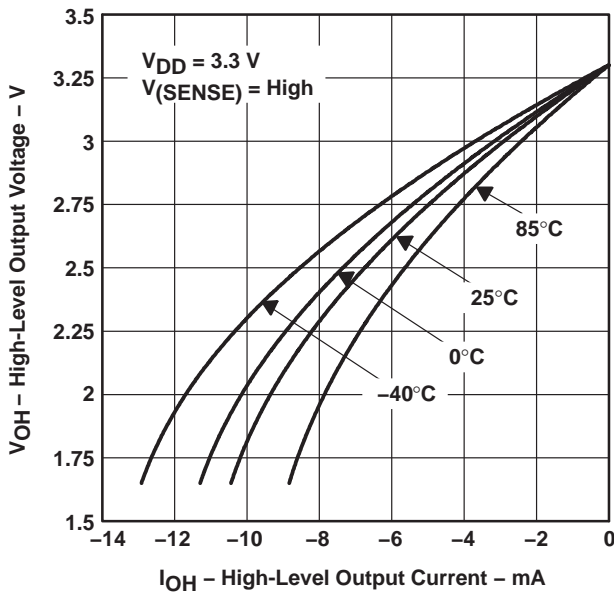

Figure 7

TPS3805H33  
 HIGH-LEVEL OUTPUT VOLTAGE  
 vs  
 HIGH-LEVEL OUTPUT CURRENT

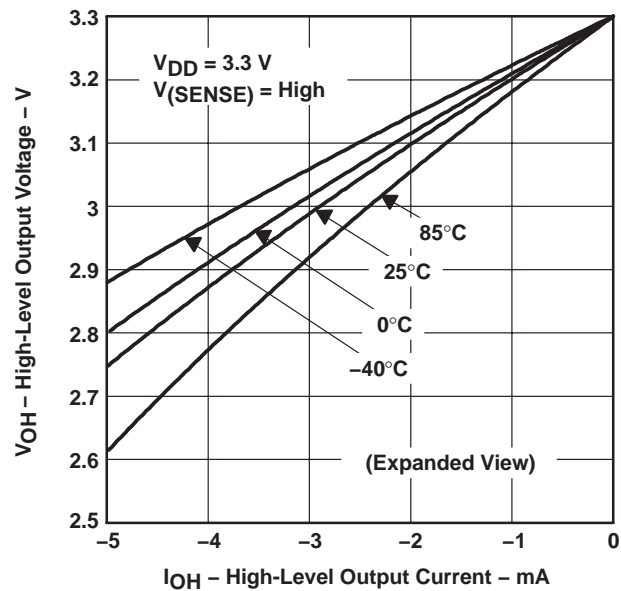

Figure 8



TYPICAL CHARACTERISTICS

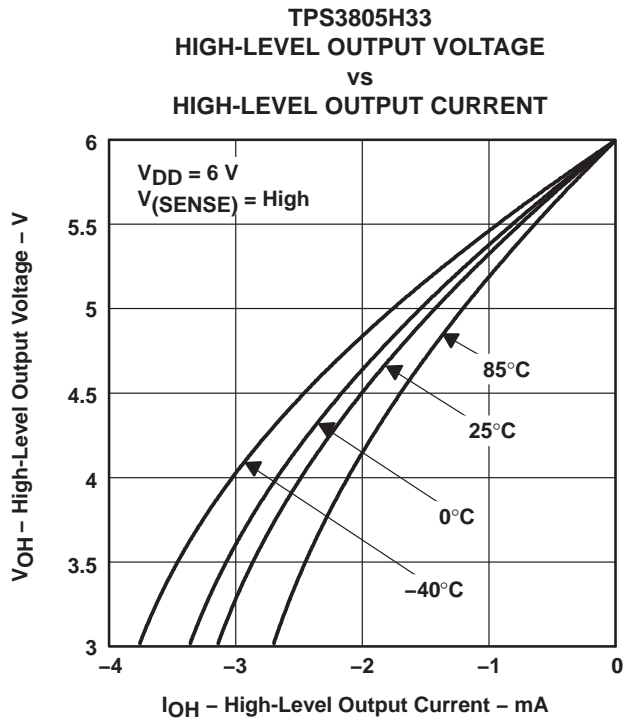

Figure 9

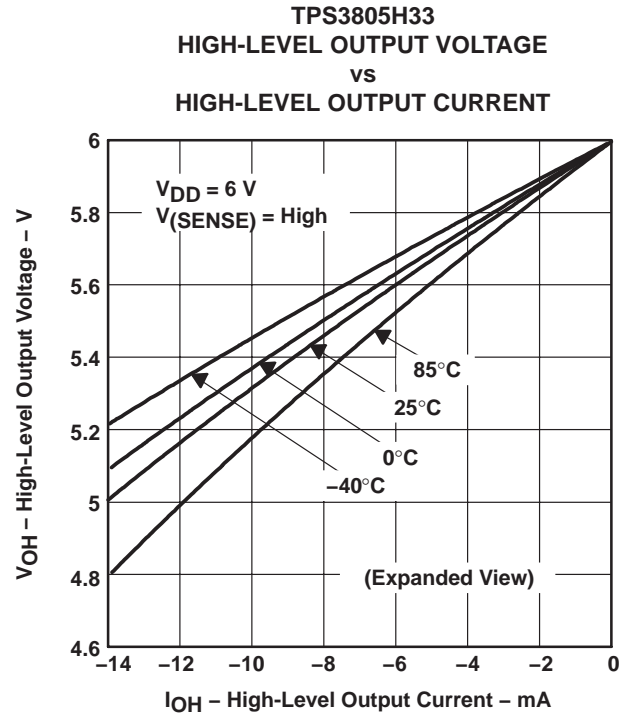

Figure 10

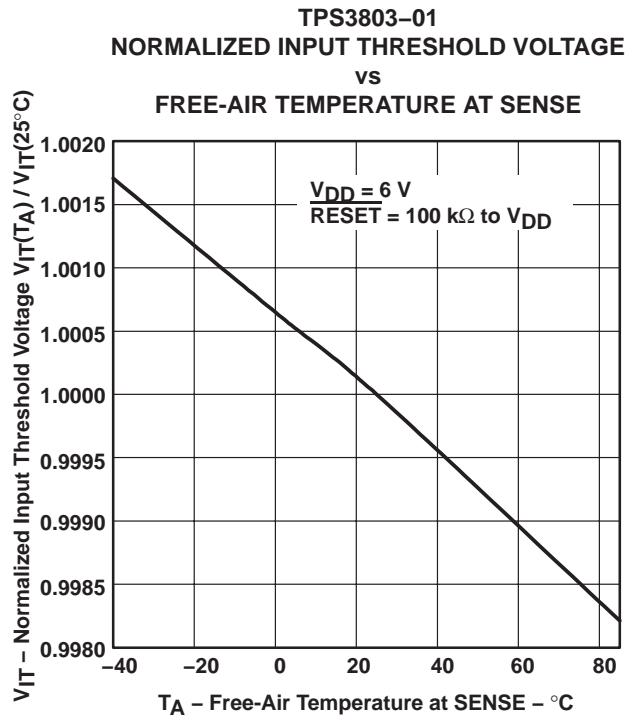

Figure 11

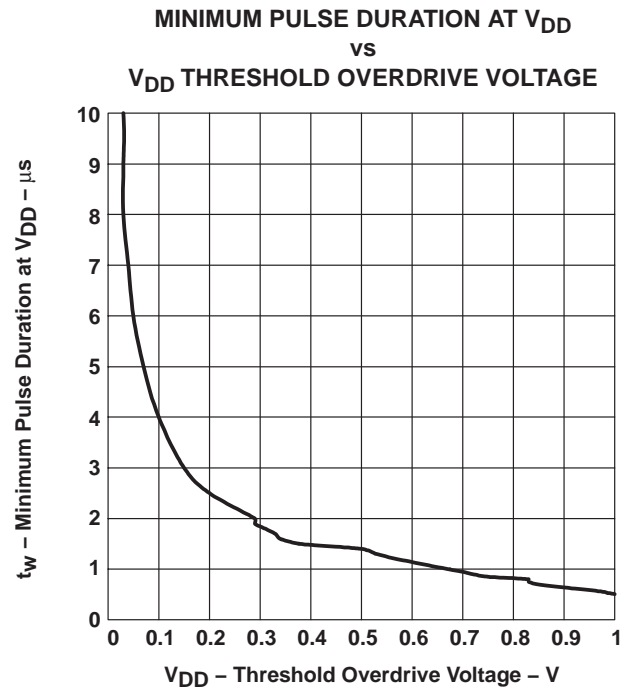

Figure 12

### TYPICAL CHARACTERISTICS

MINIMUM PULSE DURATION AT SENSE  
vs  
SENSE THRESHOLD OVERDRIVE VOLTAGE

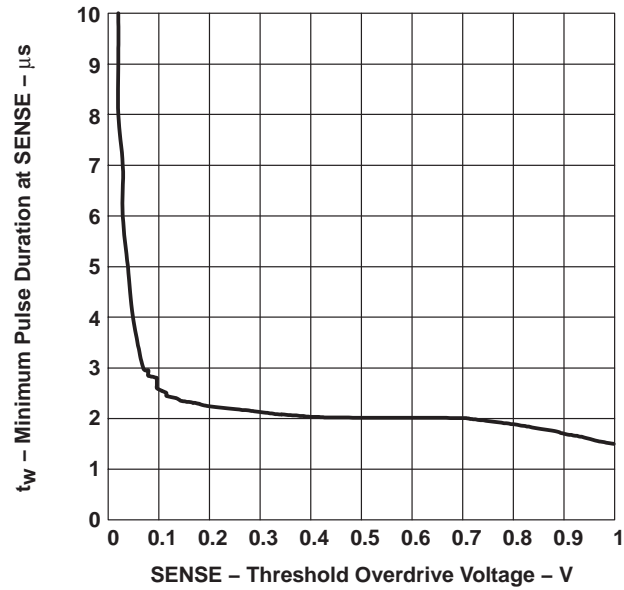

Figure 13

## Revision History

DATE	REV	PAGE	SECTION	DESCRIPTION
6/07	C	Front Page	—	Updated front page.
		3	—	Functional block diagram change.

NOTE: Page numbers for previous revisions may differ from page numbers in the current version.

---

**PACKAGING INFORMATION**

Orderable Device	Status (1)	Package Type	Package Drawing	Pins	Package Qty	Eco Plan (2)	Lead finish/ Ball material (6)	MSL Peak Temp (3)	Op Temp (°C)	Device Marking (4/5)	Samples
TPS3803-01MDCKREP	ACTIVE	SC70	DCK	5	3000	RoHS & Green	NIPDAU	Level-1-260C-UNLIM	-55 to 125	BAY	<a href="#">Samples</a>
TPS3803-01QDCKREP	ACTIVE	SC70	DCK	5	3000	RoHS & Green	NIPDAU	Level-1-260C-UNLIM	-40 to 125	AWH	<a href="#">Samples</a>
TPS3803G15MDCKREP	ACTIVE	SC70	DCK	5	3000	RoHS & Green	NIPDAUAG	Level-1-260C-UNLIM	-55 to 125	ARH	<a href="#">Samples</a>
TPS3803G15QDCKREP	ACTIVE	SC70	DCK	5	3000	RoHS & Green	NIPDAUAG	Level-1-260C-UNLIM	-40 to 125	AXT	<a href="#">Samples</a>
TPS3805H33MDCKREP	ACTIVE	SC70	DCK	5	3000	RoHS & Green	NIPDAUAG	Level-1-260C-UNLIM	-55 to 125	ARJ	<a href="#">Samples</a>
TPS3805H33QDCKREP	ACTIVE	SC70	DCK	5	3000	RoHS & Green	NIPDAUAG	Level-1-260C-UNLIM	-40 to 125	AWY	<a href="#">Samples</a>
V62/04648-01XE	ACTIVE	SC70	DCK	5	3000	RoHS & Green	NIPDAU	Level-1-260C-UNLIM	-40 to 125	AWH	<a href="#">Samples</a>
V62/04648-02XE	ACTIVE	SC70	DCK	5	3000	RoHS & Green	NIPDAUAG	Level-1-260C-UNLIM	-40 to 125	AXT	<a href="#">Samples</a>
V62/04648-03XE	ACTIVE	SC70	DCK	5	3000	RoHS & Green	NIPDAUAG	Level-1-260C-UNLIM	-40 to 125	AWY	<a href="#">Samples</a>
V62/04648-04XE	ACTIVE	SC70	DCK	5	3000	RoHS & Green	NIPDAU	Level-1-260C-UNLIM	-55 to 125	BAY	<a href="#">Samples</a>
V62/04648-05XE	ACTIVE	SC70	DCK	5	3000	RoHS & Green	NIPDAUAG	Level-1-260C-UNLIM	-55 to 125	ARH	<a href="#">Samples</a>
V62/04648-06XE	ACTIVE	SC70	DCK	5	3000	RoHS & Green	NIPDAUAG	Level-1-260C-UNLIM	-55 to 125	ARJ	<a href="#">Samples</a>

(1) The marketing status values are defined as follows:

**ACTIVE:** Product device recommended for new designs.

**LIFEBUY:** TI has announced that the device will be discontinued, and a lifetime-buy period is in effect.

**NRND:** Not recommended for new designs. Device is in production to support existing customers, but TI does not recommend using this part in a new design.

**PREVIEW:** Device has been announced but is not in production. Samples may or may not be available.

**OBSELETE:** TI has discontinued the production of the device.

(2) **RoHS:** TI defines "RoHS" to mean semiconductor products that are compliant with the current EU RoHS requirements for all 10 RoHS substances, including the requirement that RoHS substance do not exceed 0.1% by weight in homogeneous materials. Where designed to be soldered at high temperatures, "RoHS" products are suitable for use in specified lead-free processes. TI may reference these types of products as "Pb-Free".

**RoHS Exempt:** TI defines "RoHS Exempt" to mean products that contain lead but are compliant with EU RoHS pursuant to a specific EU RoHS exemption.

**Green:** TI defines "Green" to mean the content of Chlorine (Cl) and Bromine (Br) based flame retardants meet JS709B low halogen requirements of <=1000ppm threshold. Antimony trioxide based flame retardants must also meet the <=1000ppm threshold requirement.

(3) MSL, Peak Temp. - The Moisture Sensitivity Level rating according to the JEDEC industry standard classifications, and peak solder temperature.

(4) There may be additional marking, which relates to the logo, the lot trace code information, or the environmental category on the device.

(5) Multiple Device Markings will be inside parentheses. Only one Device Marking contained in parentheses and separated by a "~" will appear on a device. If a line is indented then it is a continuation of the previous line and the two combined represent the entire Device Marking for that device.

(6) Lead finish/Ball material - Orderable Devices may have multiple material finish options. Finish options are separated by a vertical ruled line. Lead finish/Ball material values may wrap to two lines if the finish value exceeds the maximum column width.

**Important Information and Disclaimer:**The information provided on this page represents TI's knowledge and belief as of the date that it is provided. TI bases its knowledge and belief on information provided by third parties, and makes no representation or warranty as to the accuracy of such information. Efforts are underway to better integrate information from third parties. TI has taken and continues to take reasonable steps to provide representative and accurate information but may not have conducted destructive testing or chemical analysis on incoming materials and chemicals. TI and TI suppliers consider certain information to be proprietary, and thus CAS numbers and other limited information may not be available for release.

In no event shall TI's liability arising out of such information exceed the total purchase price of the TI part(s) at issue in this document sold by TI to Customer on an annual basis.

**OTHER QUALIFIED VERSIONS OF TPS3803-EP, TPS3805H33-EP :**

- Catalog: [TPS3803](#), [TPS3805H33](#)
- Automotive: [TPS3803-Q1](#), [TPS3805H33-Q1](#)

NOTE: Qualified Version Definitions:

- Catalog - TI's standard catalog product
- Automotive - Q100 devices qualified for high-reliability automotive applications targeting zero defects

**TAPE AND REEL INFORMATION**

**QUADRANT ASSIGNMENTS FOR PIN 1 ORIENTATION IN TAPE**

\*All dimensions are nominal

Device	Package Type	Package Drawing	Pins	SPQ	Reel Diameter (mm)	Reel Width W1 (mm)	A0 (mm)	B0 (mm)	K0 (mm)	P1 (mm)	W (mm)	Pin1 Quadrant
TPS3803-01MDCKREP	SC70	DCK	5	3000	180.0	8.4	2.4	2.5	1.2	4.0	8.0	Q3
TPS3803-01QDCKREP	SC70	DCK	5	3000	180.0	8.4	2.4	2.5	1.2	4.0	8.0	Q3
TPS3803G15MDCKREP	SC70	DCK	5	3000	180.0	8.4	2.41	2.41	1.2	4.0	8.0	Q3
TPS3803G15QDCKREP	SC70	DCK	5	3000	180.0	8.4	2.41	2.41	1.2	4.0	8.0	Q3
TPS3805H33MDCKREP	SC70	DCK	5	3000	180.0	8.4	2.41	2.41	1.2	4.0	8.0	Q3
TPS3805H33QDCKREP	SC70	DCK	5	3000	180.0	8.4	2.41	2.41	1.2	4.0	8.0	Q3

**TAPE AND REEL BOX DIMENSIONS**

\*All dimensions are nominal

Device	Package Type	Package Drawing	Pins	SPQ	Length (mm)	Width (mm)	Height (mm)
TPS3803-01MDCKREP	SC70	DCK	5	3000	202.0	201.0	28.0
TPS3803-01QDCKREP	SC70	DCK	5	3000	202.0	201.0	28.0
TPS3803G15MDCKREP	SC70	DCK	5	3000	202.0	201.0	28.0
TPS3803G15QDCKREP	SC70	DCK	5	3000	202.0	201.0	28.0
TPS3805H33MDCKREP	SC70	DCK	5	3000	202.0	201.0	28.0
TPS3805H33QDCKREP	SC70	DCK	5	3000	202.0	201.0	28.0

# DCK0005A



## PACKAGE OUTLINE

SOT - 1.1 max height

SMALL OUTLINE TRANSISTOR

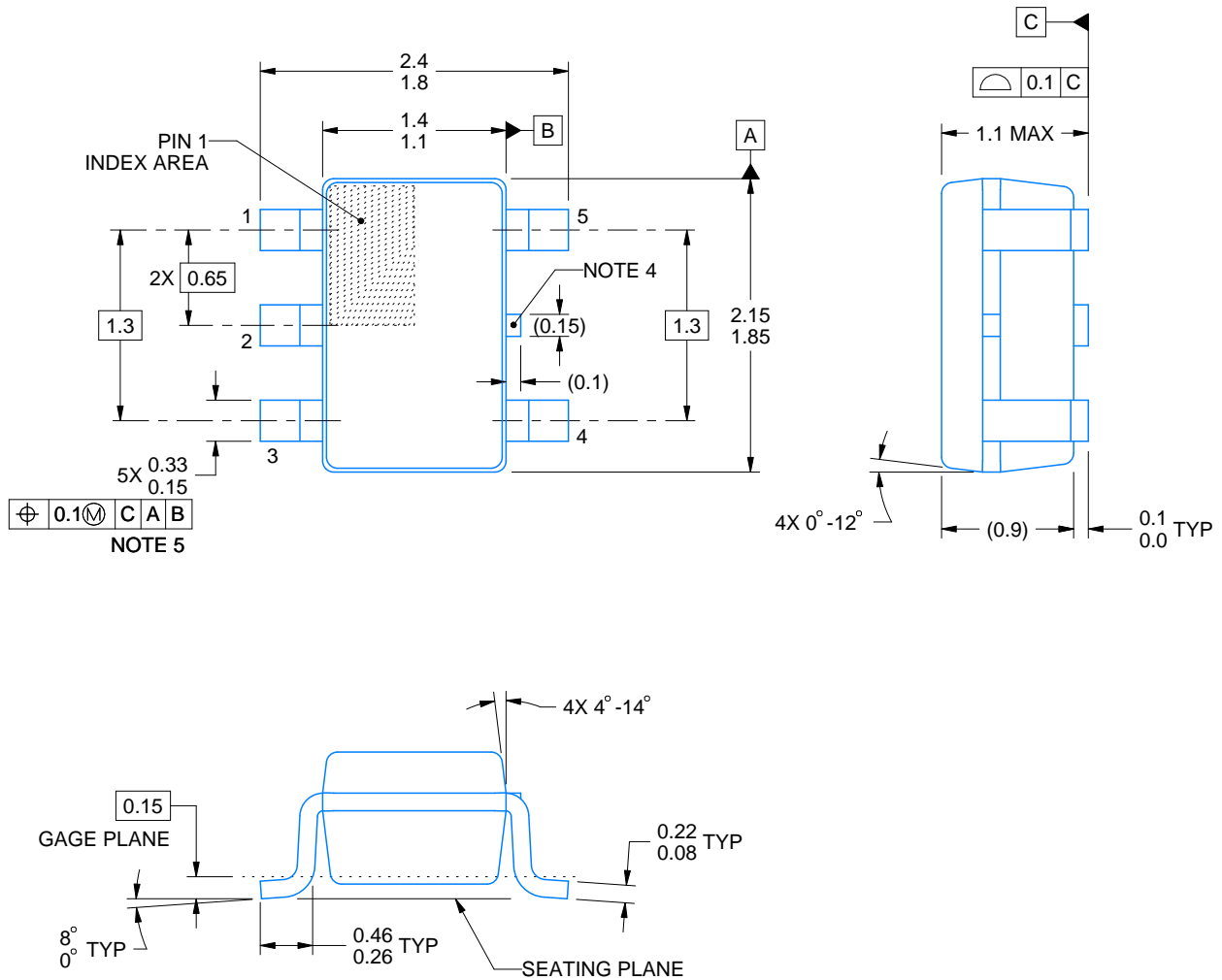

4214834/F 08/2024

### NOTES:

1. All linear dimensions are in millimeters. Any dimensions in parenthesis are for reference only. Dimensioning and tolerancing per ASME Y14.5M.
2. This drawing is subject to change without notice.
3. Reference JEDEC MO-203.
4. Support pin may differ or may not be present.
5. Lead width does not comply with JEDEC.
6. Body dimensions do not include mold flash, protrusions, or gate burrs. Mold flash, protrusions, or gate burrs shall not exceed 0.25mm per side



# EXAMPLE BOARD LAYOUT

DCK0005A

SOT - 1.1 max height

SMALL OUTLINE TRANSISTOR



LAND PATTERN EXAMPLE  
EXPOSED METAL SHOWN  
SCALE:18X



SOLDER MASK DETAILS

4214834/F 08/2024

NOTES: (continued)

- 7. Publication IPC-7351 may have alternate designs.
- 8. Solder mask tolerances between and around signal pads can vary based on board fabrication site.

# EXAMPLE STENCIL DESIGN

DCK0005A

SOT - 1.1 max height

SMALL OUTLINE TRANSISTOR

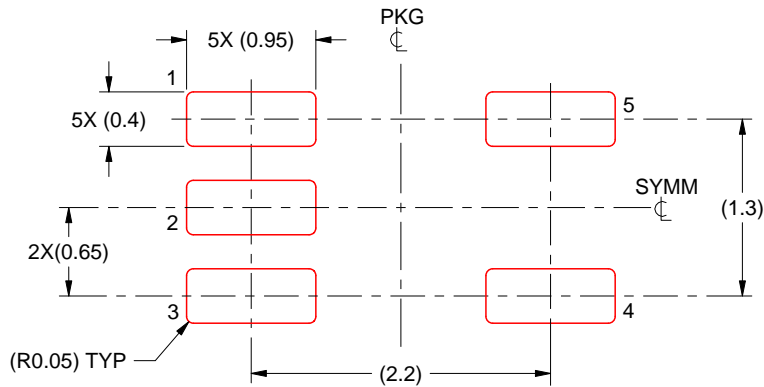

SOLDER PASTE EXAMPLE  
BASED ON 0.125 THICK STENCIL  
SCALE: 18X

4214834/F 08/2024

NOTES: (continued)

9. Laser cutting apertures with trapezoidal walls and rounded corners may offer better paste release. IPC-7525 may have alternate design recommendations.
10. Board assembly site may have different recommendations for stencil design.

## IMPORTANT NOTICE AND DISCLAIMER

TI PROVIDES TECHNICAL AND RELIABILITY DATA (INCLUDING DATA SHEETS), DESIGN RESOURCES (INCLUDING REFERENCE DESIGNS), APPLICATION OR OTHER DESIGN ADVICE, WEB TOOLS, SAFETY INFORMATION, AND OTHER RESOURCES "AS IS" AND WITH ALL FAULTS, AND DISCLAIMS ALL WARRANTIES, EXPRESS AND IMPLIED, INCLUDING WITHOUT LIMITATION ANY IMPLIED WARRANTIES OF MERCHANTABILITY, FITNESS FOR A PARTICULAR PURPOSE OR NON-INFRINGEMENT OF THIRD PARTY INTELLECTUAL PROPERTY RIGHTS.

These resources are intended for skilled developers designing with TI products. You are solely responsible for (1) selecting the appropriate TI products for your application, (2) designing, validating and testing your application, and (3) ensuring your application meets applicable standards, and any other safety, security, regulatory or other requirements.

These resources are subject to change without notice. TI grants you permission to use these resources only for development of an application that uses the TI products described in the resource. Other reproduction and display of these resources is prohibited. No license is granted to any other TI intellectual property right or to any third party intellectual property right. TI disclaims responsibility for, and you will fully indemnify TI and its representatives against, any claims, damages, costs, losses, and liabilities arising out of your use of these resources.

TI's products are provided subject to [TI's Terms of Sale](#) or other applicable terms available either on [ti.com](https://www.ti.com) or provided in conjunction with such TI products. TI's provision of these resources does not expand or otherwise alter TI's applicable warranties or warranty disclaimers for TI products.

TI objects to and rejects any additional or different terms you may have proposed.

Mailing Address: Texas Instruments, Post Office Box 655303, Dallas, Texas 75265  
Copyright © 2024, Texas Instruments Incorporated