

# TPS7B92 300mA, 40V, 1.8 $\mu$ A $I_Q$ , Low-Dropout Linear Regulator

## 1 Features

- Input voltage range: 2.5V to 40V
- Available output voltage options:
  - Fixed: 1.2V to 12V
  - Adjustable: 1.205V to  $V_{IN} - V_{DO}$
- Output current: 300mA
- Ultra-low  $I_Q$ : 1.8 $\mu$ A at  $I_{OUT} = 0$ mA
- Stable with output capacitors  $\geq 1.0\mu$ F
- High PSRR:
  - 70dB at 1kHz
  - 43dB at 100kHz
- Fold-back current limiting
- Overtemperature protection
- Package:
  - 5-pin SOT-23 (DBV)
- Operating junction temperature:  $-40^{\circ}\text{C}$  to  $+125^{\circ}\text{C}$

## 2 Applications

- [Appliances](#)
- [Home and building automation](#)
- [Retail automation and payment](#)
- [Grid infrastructure](#)
- [Medical applications](#)
- [Lighting applications](#)

## 3 Description

The TPS7B92 low-dropout (LDO) linear voltage regulator is a low quiescent current device. The TPS7B92 offers a wide input voltage range (up to 40V), wide output range, and low-power operation in miniaturized packaging. The wide output range is up to  $V_{IN} - V_{DO}$  for the adjustable configuration or up to 12V for the fixed configuration.

The TPS7B92 is optimized to power microcontrollers and other low power loads for battery-powered applications. The TPS7B92 is stable with a output capacitor range of 1.0 $\mu$ F to 47 $\mu$ F.

The TPS7B92 low quiescent current (1.8 $\mu$ A typically) makes this device designed for battery-powered or always-on systems that require very little idle-state power dissipation.

The TPS7B92 LDO supports a low dropout of typically 900mV at 150mA of load current. The TPS7B92 also features an internal soft-start to lower the inrush current during start-up. The built-in fold-back overcurrent limit protection and thermal shutdown helps protect the regulator in the event of a load short or fault condition.

The TPS7B92 is available in a 2.9mm  $\times$  2.8mm, 5-pin SOT-23 (DBV) package for fixed and adjustable outputs.

### Package Information

PART NUMBER	PACKAGE <sup>(1)</sup>	PACKAGE SIZE <sup>(2)</sup>
TPS7B92	DBV (SOT-23, 5)	2.9mm $\times$ 2.8mm

- (1) For more information, see the [Mechanical, Packaging, and Orderable Information](#).
- (2) The package size (length  $\times$  width) is a nominal value and includes pins, where applicable.

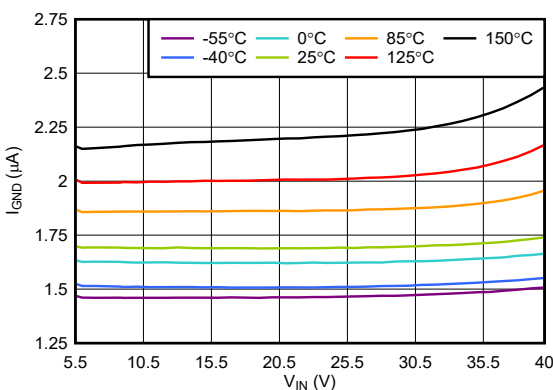

$I_{QND}$  vs  $V_{IN}$  ( $V_{OUT} = 5.0\text{V}$ ,  $I_{OUT} = 0\text{mA}$ )

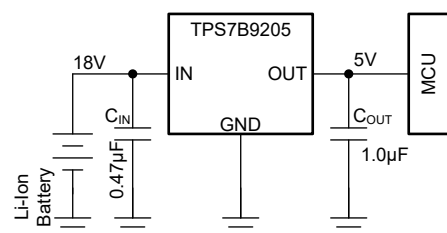

Typical Application



## Table of Contents

<b>1 Features</b> .....	1	7.1 Application Information.....	19
<b>2 Applications</b> .....	1	7.2 Typical Application.....	19
<b>3 Description</b> .....	1	7.3 Best Design Practices.....	27
<b>4 Pin Configuration and Functions</b> .....	3	7.4 Power Supply Recommendations.....	27
<b>5 Specifications</b> .....	4	7.5 Layout.....	27
5.1 Absolute Maximum Ratings.....	4	<b>8 Device and Documentation Support</b> .....	29
5.2 ESD Ratings.....	4	8.1 Device Support.....	29
5.3 Recommended Operating Conditions.....	5	8.2 Documentation Support.....	29
5.4 Thermal Information.....	5	8.3 Receiving Notification of Documentation Updates....	29
5.5 Electrical Characteristics.....	5	8.4 Support Resources.....	29
5.6 Typical Characteristics.....	7	8.5 Trademarks.....	29
<b>6 Detailed Description</b> .....	16	8.6 Electrostatic Discharge Caution.....	29
6.1 Overview.....	16	8.7 Glossary.....	29
6.2 Functional Block Diagrams.....	16	<b>9 Revision History</b> .....	30
6.3 Feature Description.....	17	<b>10 Mechanical, Packaging, and Orderable Information</b> .....	30
6.4 Device Functional Modes.....	18		
<b>7 Application and Implementation</b> .....	19		

## 4 Pin Configuration and Functions

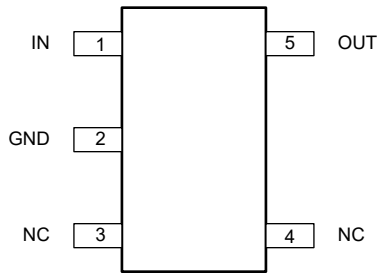

Figure 4-1. DBV Package (Fixed), 5-Pin SOT-23 (Top View)

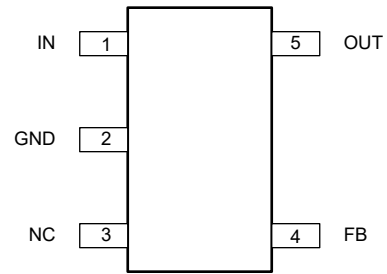

Figure 4-2. DBV Package (Adjustable), 5-Pin SOT-23 (Top View)

Table 4-1. Pin Functions

NAME	PIN		TYPE	DESCRIPTION
	DBV (Fixed)	DBV (Adj)		
GND	2	2	—	Ground pin.
IN	1	1	I	Input supply pin. See the <a href="#">Recommended Operating Conditions</a> table and the <a href="#">Input and Output Capacitor Requirements</a> section for more information.
OUT	5	5	O	Output of the regulator. See the <a href="#">Recommended Operating Conditions</a> table and the <a href="#">Input and Output Capacitor Requirements</a> section for more information.
FB	—	4	I	In the adjustable configuration, this pin sets the output voltage with the help of a feedback divider.
NC	3, 4	3	—	Not internally connected. Leave this pin open or connected to any potential. Tie this pin to ground for improved thermal performance.

## 5 Specifications

### 5.1 Absolute Maximum Ratings

over operating free-air temperature range (unless otherwise noted)<sup>(1)</sup>

		MIN	MAX	UNIT
Voltage <sup>(2)</sup>	V <sub>IN</sub>	-0.3	42	V
	V <sub>OUT</sub> (for fixed only)	-0.3	2 × V <sub>OUT(typ)</sub> or V <sub>IN</sub> + 0.3 or 15 (whichever is lower) <sup>(2)</sup>	
	V <sub>OUT</sub> (for adjustable only)	-0.3	42 or V <sub>IN</sub> + 0.3 (whichever is lower)	
	V <sub>FB</sub>	-0.3	3.6	
Power dissipation <sup>(3) (4)</sup>	SOT-23 (DBV)	T <sub>A</sub> = -55°C	1.775	W
		T <sub>A</sub> = +25°C	1.375	
		T <sub>A</sub> = +125°C	0.875	
Current	V <sub>OUT</sub>	Internally limited		A
Temperature	Operating junction, T <sub>J</sub>	-55	125	°C
	Storage, T <sub>stg</sub>	-65	150	

- (1) Operation outside the *Absolute Maximum Ratings* may cause permanent device damage. *Absolute Maximum Ratings* do not imply functional operation of the device at these or any other conditions beyond those listed under *Recommended Operating Conditions*. If used outside the *Recommended Operating Conditions* but within the *Absolute Maximum Ratings*, the device may not be fully functional, and this may affect device reliability, functionality, performance, and shorten the device lifetime.
- (2) All voltage values are with respect to the ground terminal.
- (3) The power dissipation rating is defined as the continuous peak power that is dissipated across a voltage regulator over a 24-hour period. This rating represents the maximum amount of heat energy that the voltage regulator handles without exceeding safe operating limits during continuous operation.
- (4) The power dissipation values mentioned in *Absolute Maximum Ratings* are PCB mounted and is for reference only. The PCB configuration is based on JEDEC standard of 2s2p configuration (EIA/JESD51-x).

### 5.2 ESD Ratings

			VALUE	UNIT
V <sub>(ESD)</sub>	Electrostatic discharge	Human body model (HBM), per ANSI/ESDA/ JEDEC JS-001, all pins <sup>(1)</sup>	±750	V
		Charged device model (CDM), per JEDEC specification JESD22-C101, all pins <sup>(2)</sup>	±500	

- (1) JEDEC document JEP155 states that 500V HBM allows safe manufacturing with a standard ESD control process.
- (2) JEDEC document JEP157 states that 250V CDM allows safe manufacturing with a standard ESD control process.

### 5.3 Recommended Operating Conditions

over operating junction temperature range (unless otherwise noted)

		MIN	NOM	MAX	UNIT
V <sub>IN</sub>	Input supply voltage	2.5		40	V
V <sub>OUT</sub>	Output voltage <sup>(1)</sup>	1.2		38	V
I <sub>OUT</sub>	Output current	0		300	mA
C <sub>IN</sub>	Input capacitor <sup>(2)</sup>		0.47		μF
C <sub>OUT</sub>	Output capacitor <sup>(3)</sup>	1		47	μF
T <sub>J</sub>	Operating junction temperature	−40		125	°C

- (1) All voltages are with respect to GND.
- (2) An input capacitor is not required for LDO stability. However, an input capacitance with an effective value of 0.1 μF minimum is recommended to counteract the effect of source resistance and inductance, which may in some cases cause symptoms of system-level instability such as ringing or oscillation, especially in the presence of load transients.
- (3) All capacitor values listed are the nominal value and the effective capacitance is assumed to derate to 50% of the nominal capacitor value.

### 5.4 Thermal Information

THERMAL METRIC <sup>(1)</sup>		TPS7B92			UNIT
		DBV (SOT-23) <sup>(2)</sup>			
		5 PINS			
R <sub>θJA</sub>	Junction-to-ambient thermal resistance	207.0			°C/W
R <sub>θJC(top)</sub>	Junction-to-case (top) thermal resistance	104.7			°C/W
R <sub>θJB</sub>	Junction-to-board thermal resistance	73.6			°C/W
Ψ <sub>JT</sub>	Junction-to-top characterization parameter	40.6			°C/W
Ψ <sub>JB</sub>	Junction-to-board characterization parameter	73.2			°C/W
R <sub>θJC(bot)</sub>	Junction-to-case (bottom) thermal resistance	n/a			°C/W

- (1) For more information about traditional and new thermal metrics, see the [Semiconductor and IC Package Thermal Metrics](#) application note.
- (2) Thermal performance results are based on the JEDEC standard of 2s2p PCB configuration. These thermal metric parameters are further improved by 35-55% based on thermally optimized PCB layout designs. See the analysis of the [Impact of board layout on LDO thermal performance](#) application note.

### 5.5 Electrical Characteristics

over operating junction temperature range (T<sub>J</sub> = −40°C to +125°C), V<sub>IN</sub> = 2.5V or V<sub>IN</sub> = V<sub>OUT</sub>(nom) + 0.5V (whichever is greater), C<sub>IN</sub> = 1μF, C<sub>OUT</sub> = 1μF, and I<sub>OUT</sub> = 1mA (unless otherwise noted); typical values are at T<sub>J</sub> = 25°C <sup>(1)</sup>

PARAMETER		TEST CONDITIONS		MIN	TYP	MAX	UNIT
V <sub>IN</sub>	Input voltage			2.5		40	V
I <sub>OUT</sub> <sup>(2) (3)</sup>	Maximum output current				300		mA
V <sub>FB</sub>	Feedback voltage	V <sub>OUT</sub> + 3.8V ≤ V <sub>IN</sub> ≤ 40V, T <sub>J</sub> = 25°C		1.169	1.205	1.237	V
		V <sub>OUT</sub> + 3.8V ≤ V <sub>IN</sub> ≤ 40V, −40°C ≤ T <sub>J</sub> ≤ 125°C		1.169	1.205	1.237	
V <sub>OUT</sub>	Output voltage	V <sub>OUT</sub> = 1.8V	V <sub>IN</sub> = V <sub>OUT</sub> + 3.8V, 100μA ≤ I <sub>OUT</sub> ≤ 300mA, T <sub>J</sub> = 25°C	−3.0		4.5	%
		V <sub>OUT</sub> = 3.3V		−2.75		4.25	
		V <sub>OUT</sub> = 5.0V		−3.75		4.25	
		V <sub>OUT</sub> = 12V		−5.25		5.25	
		V <sub>OUT</sub> = 1.8V	V <sub>IN</sub> = V <sub>OUT</sub> + 3.8V, 100μA ≤ I <sub>OUT</sub> ≤ 300mA, −40°C ≤ T <sub>J</sub> ≤ 125°C	−3.75		5.0	
		V <sub>OUT</sub> = 3.3V		−3.5		5.0	
		V <sub>OUT</sub> = 5.0V		−4.25		4.75	
		V <sub>OUT</sub> = 12V		−5.75		5.75	

## 5.5 Electrical Characteristics (continued)

over operating junction temperature range ( $T_J = -40^\circ\text{C}$  to  $+125^\circ\text{C}$ ),  $V_{IN} = 2.5\text{V}$  or  $V_{IN} = V_{OUT(\text{nom})} + 0.5\text{V}$  (whichever is greater),  $C_{IN} = 1\mu\text{F}$ ,  $C_{OUT} = 1\mu\text{F}$ , and  $I_{OUT} = 1\text{mA}$  (unless otherwise noted); typical values are at  $T_J = 25^\circ\text{C}$  <sup>(1)</sup>

PARAMETER		TEST CONDITIONS	MIN	TYP	MAX	UNIT
$\Delta V_{OUT}/V_{IN}$	Line regulation	$I_{OUT} = 1\text{mA}$ , $V_{OUT} + 1\text{V} \leq V_{IN} \leq 40\text{V}$		0.000 05	0.007	%/V
$\Delta V_{OUT}/I_{OUT}$	Load regulation	$V_{IN} = V_{OUT} + 2\text{V}$ , $100\mu\text{A} \leq I_{OUT} \leq 150\text{mA}$		0.1		%/A
$\Delta V_{OUT}/I_{OUT}$	Load regulation	$V_{IN} = V_{OUT} + 3.8\text{V}$ , $100\mu\text{A} \leq I_{OUT} \leq 300\text{mA}$		0.3		%/A
$V_{DO}$	Dropout voltage	$I_{OUT} = 50\text{mA}$		440	700	mV
$V_{DO}$	Dropout voltage	$I_{OUT} = 150\text{mA}$		1100	1800	mV
$V_{DO}$	Dropout voltage	$I_{OUT} = 300\text{mA}$		2175	3700	mV
$I_{LIM}$	Output current limit	$V_{OUT} = 0.90 \cdot V_{OUT(\text{nom})}$ , $V_{IN} = V_{OUT(\text{nom})} + 9\text{V}$	320	530	740	mA
$I_{SC}$	Short-circuit current limit	$V_{OUT} = 0\text{V}$ , $V_{IN} = V_{OUT(\text{nom})} + 6\text{V}$	75	175	290	mA
$I_{GND}$	GND pin current	$V_{IN} = V_{OUT(\text{nom})} + 0.5\text{V}$ , $I_{OUT} = 0\text{mA}$ , $T_J = 25^\circ\text{C}$ (fixed)		1.7	2.65	$\mu\text{A}$
		$V_{IN} = V_{OUT(\text{nom})} + 0.5\text{V}$ , $I_{OUT} = 0\text{mA}$ , $T_J = 25^\circ\text{C}$ (adjustable)		1.3	2.65	
		$V_{IN} = V_{OUT(\text{nom})} + 0.5\text{V}$ , $I_{OUT} = 0\text{mA}$ , $T_J = -40^\circ\text{C}$ to $85^\circ\text{C}$			2.9	
		$V_{IN} = V_{OUT(\text{nom})} + 0.5\text{V}$ , $I_{OUT} = 0\text{mA}$ , $T_J = -40^\circ\text{C}$ to $125^\circ\text{C}$			3	
		$V_{IN} = V_{OUT(\text{nom})} + 0.5\text{V}$ , $I_{OUT} = 100\mu\text{A}$ (fixed)		2.8		
		$V_{IN} = V_{OUT(\text{nom})} + 0.5\text{V}$ , $I_{OUT} = 100\mu\text{A}$ (adjustable)		2.4		
$I_{GND}$	GND pin current	$V_{IN} = V_{OUT(\text{nom})} + 3.8\text{V}$ , $I_{OUT} = 300\text{mA}$		250		$\mu\text{A}$
$I_{FB}$	FB pin leakage current	$V_{IN} = 40\text{V}$			25	nA
PSRR	Power-supply ripple rejection	$V_{IN} = V_{OUT(\text{nom})} + 1\text{V}$ , $I_{OUT} = 50\text{mA}$ , $C_{OUT} = 0.47\mu\text{F}$ , $f = 10\text{kHz}$		55		dB
		$V_{IN} = V_{OUT(\text{nom})} + 1\text{V}$ , $I_{OUT} = 50\text{mA}$ , $C_{OUT} = 0.47\mu\text{F}$ , $f = 100\text{kHz}$		43		
$V_n$	Output noise voltage	Bandwidth = 10Hz to 100kHz, $V_{IN} = V_{OUT(\text{nom})} + 3.8\text{V}$ , $I_{OUT} = 300\text{mA}$ , $C_{OUT} = 1\mu\text{F}$		525		$\mu\text{V}_{\text{RMS}}$
$T_{sd+}$	Thermal shutdown temperature increasing	Shutdown, temperature increasing		160		$^\circ\text{C}$
$T_{sd-}$	Thermal shutdown temperature decreasing	Reset, temperature decreasing		140		$^\circ\text{C}$
$t_{sup}$ <sup>(4)</sup>	Start-up time			400		$\mu\text{s}$

- (1) Pulse-testing techniques are used to maintain virtual junction temperature as close as possible to ambient temperature; take thermal effects into account separately.
- (2) Higher power dissipation across the voltage regulator leads to activation of thermal shutdown circuit, preventing attainment of maximum output current.
- (3) Maximum supported power dissipation ratings are listed in *Absolute Maximum Rating* table. Exceeding these ratings leads to permanent SOA damage to the voltage regulator.
- (4) Start-up time is measured as difference between  $t = 0$  when  $V_{IN}$  is ramped at slew rate more than  $1\text{V}/\mu\text{s}$  and the time when  $V_{OUT}$  reaches 95% of  $V_{OUT(\text{nom})}$  value.

## 5.6 Typical Characteristics

at operating junction temperature  $T_J = 25^\circ\text{C}$ ,  $V_{IN} = 2.5\text{V}$  or  $V_{IN} = V_{OUT}(\text{nom}) + 0.5\text{V}$  (whichever is greater),  $C_{IN} = 1\mu\text{F}$ ,  $C_{OUT} = 1\mu\text{F}$ , and  $I_{OUT} = 1\text{mA}$  (unless otherwise noted)

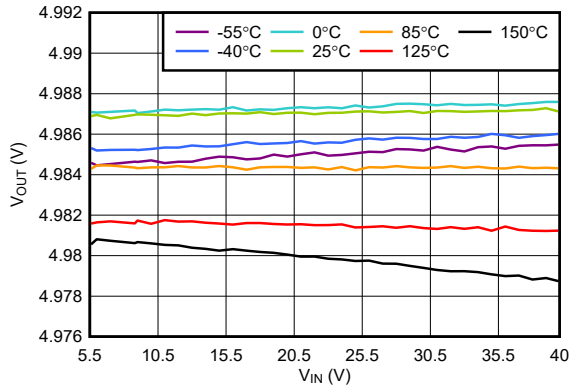

$V_{OUT} = 5.0\text{V}$ ,  $I_{OUT} = 10\text{mA}$   
**Figure 5-1.  $V_{OUT}$  vs  $V_{IN}$**

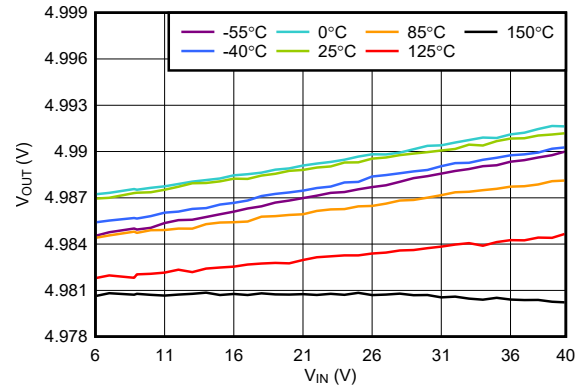

$V_{OUT} = 5.0\text{V}$ ,  $I_{OUT} = 50\text{mA}$   
**Figure 5-2.  $V_{OUT}$  vs  $V_{IN}$**

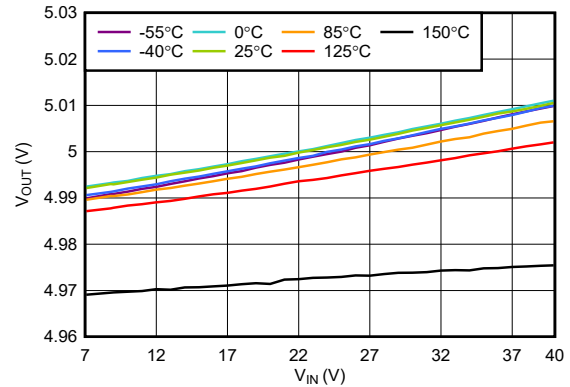

$V_{OUT} = 5.0\text{V}$ ,  $I_{OUT} = 150\text{mA}$   
**Figure 5-3.  $V_{OUT}$  vs  $V_{IN}$**

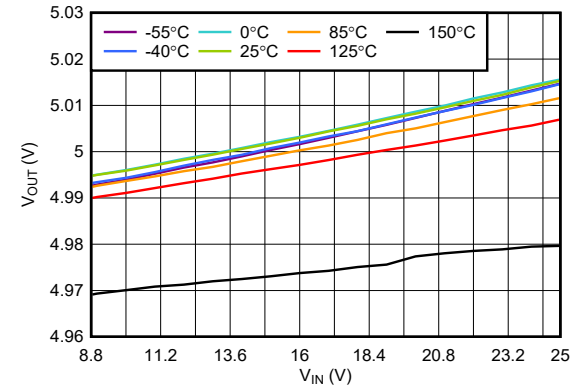

$V_{OUT} = 5.0\text{V}$ ,  $I_{OUT} = 300\text{mA}$   
**Figure 5-4.  $V_{OUT}$  vs  $V_{IN}$**

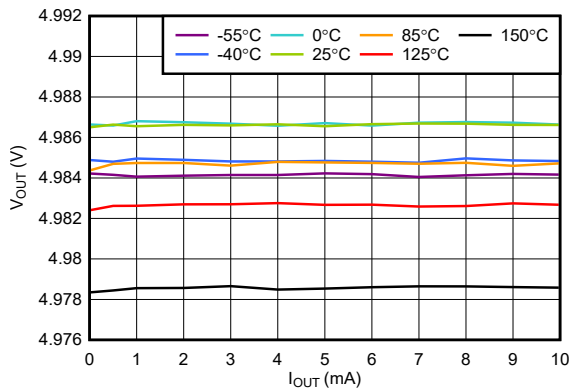

$V_{IN} = 5.5\text{V}$ ,  $V_{OUT} = 5.0\text{V}$   
**Figure 5-5.  $V_{OUT}$  vs  $I_{OUT}$**

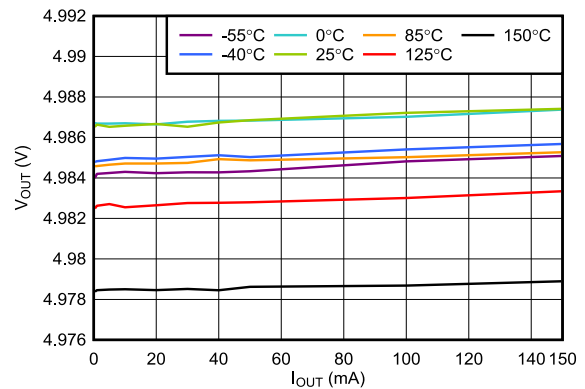

$V_{IN} = 7.0\text{V}$ ,  $V_{OUT} = 5.0\text{V}$   
**Figure 5-6.  $V_{OUT}$  vs  $I_{OUT}$**

## 5.6 Typical Characteristics (continued)

at operating junction temperature  $T_J = 25^\circ\text{C}$ ,  $V_{IN} = 2.5\text{V}$  or  $V_{IN} = V_{OUT}(\text{nom}) + 0.5\text{V}$  (whichever is greater),  $C_{IN} = 1\mu\text{F}$ ,  $C_{OUT} = 1\mu\text{F}$ , and  $I_{OUT} = 1\text{mA}$  (unless otherwise noted)

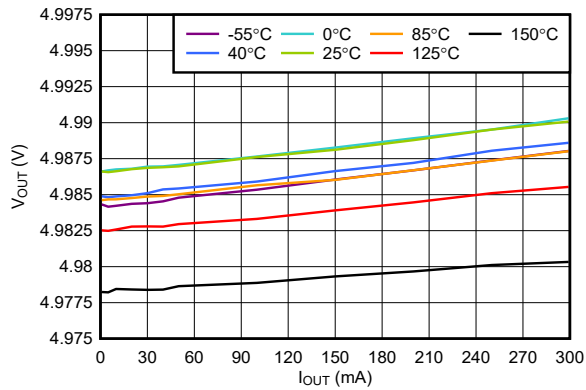

$V_{IN} = 8.8\text{V}$ ,  $V_{OUT} = 5.0\text{V}$

**Figure 5-7.  $V_{OUT}$  vs  $I_{OUT}$**

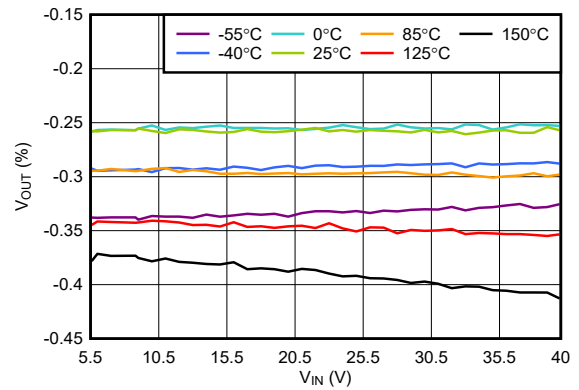

$V_{OUT} = 5.0\text{V}$ ,  $I_{OUT} = 1.0\text{mA}$

**Figure 5-8.  $V_{OUT}$  Accuracy vs  $V_{IN}$**

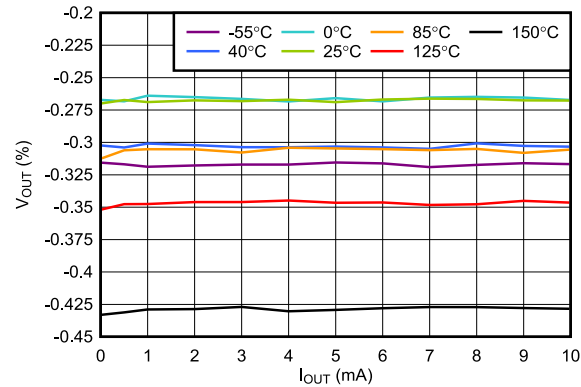

$V_{IN} = 5.5\text{V}$ ,  $V_{OUT} = 5.0\text{V}$

**Figure 5-9.  $V_{OUT}$  Accuracy vs  $I_{OUT}$**

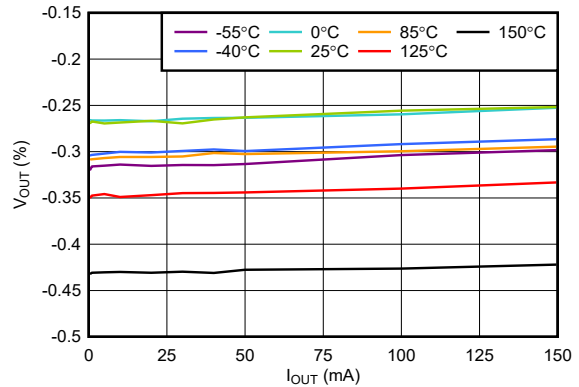

$V_{IN} = 7.0\text{V}$ ,  $V_{OUT} = 5.0\text{V}$

**Figure 5-10.  $V_{OUT}$  Accuracy vs  $I_{OUT}$**

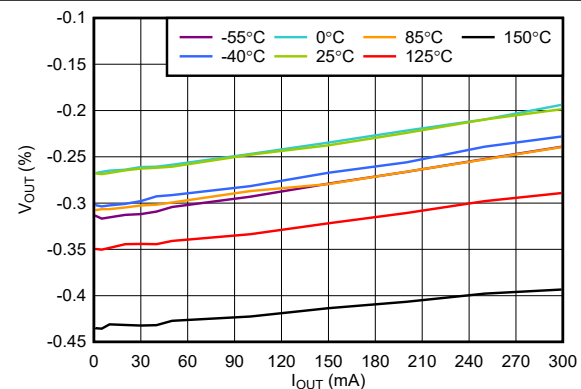

$V_{IN} = 8.8\text{V}$ ,  $V_{OUT} = 5.0\text{V}$

**Figure 5-11.  $V_{OUT}$  Accuracy vs  $I_{OUT}$**

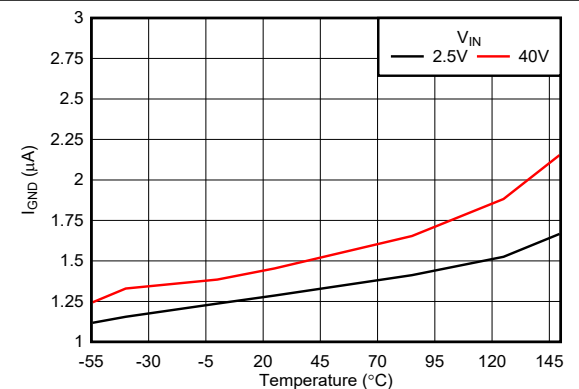

For adjustable configuration

**Figure 5-12.  $I_{GND}$  vs Temperature**



### 5.6 Typical Characteristics (continued)

at operating junction temperature  $T_J = 25^\circ\text{C}$ ,  $V_{IN} = 2.5\text{V}$  or  $V_{IN} = V_{OUT}(\text{nom}) + 0.5\text{V}$  (whichever is greater),  $C_{IN} = 1\mu\text{F}$ ,  $C_{OUT} = 1\mu\text{F}$ , and  $I_{OUT} = 1\text{mA}$  (unless otherwise noted)

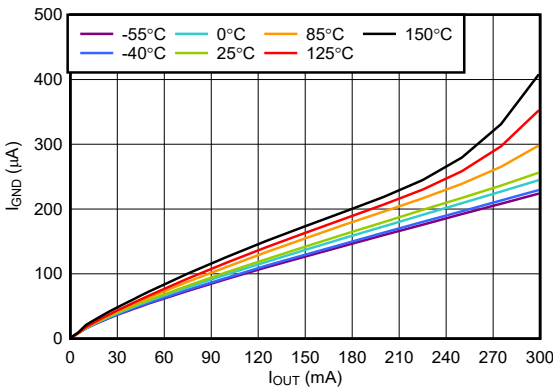

$V_{IN} = 8.8\text{V}$ ,  $V_{OUT} = 5.0\text{V}$

Figure 5-13.  $I_{GND}$  vs  $I_{OUT}$

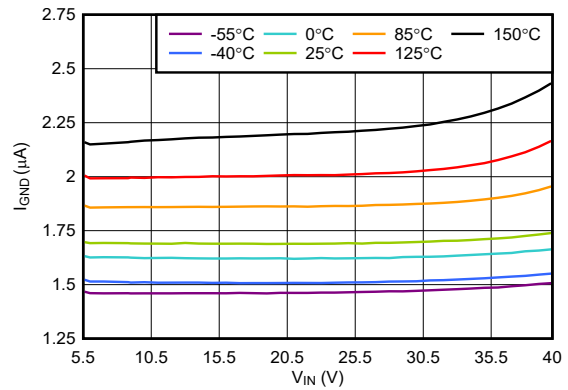

$V_{OUT} = 5.0\text{V}$ ,  $I_{OUT} = 0\text{mA}$

Figure 5-14.  $I_{GND}$  vs  $V_{IN}$

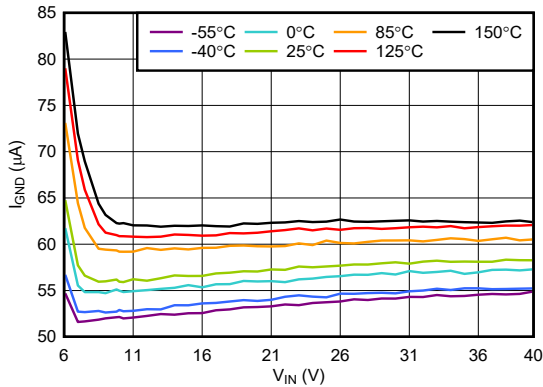

$V_{OUT} = 5.0\text{V}$ ,  $I_{OUT} = 50\text{mA}$

Figure 5-15.  $I_{GND}$  vs  $V_{IN}$

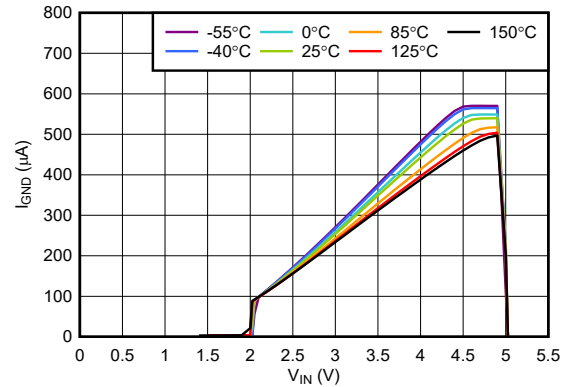

$V_{OUT} = 5.0\text{V}$ ,  $I_{OUT} = 0\text{mA}$

Figure 5-16.  $I_{GND}$  vs  $V_{IN}$  (Dropout Operation)

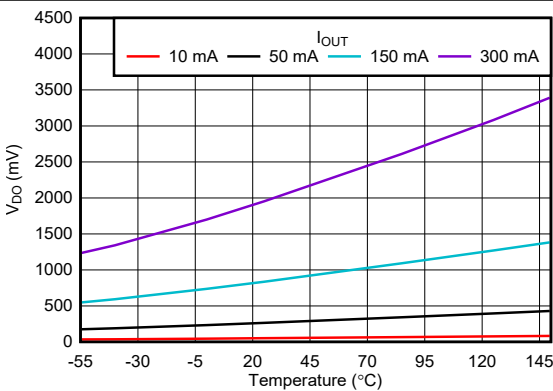

$V_{OUT} = 5.0\text{V}$

Figure 5-17. Dropout vs Temperature

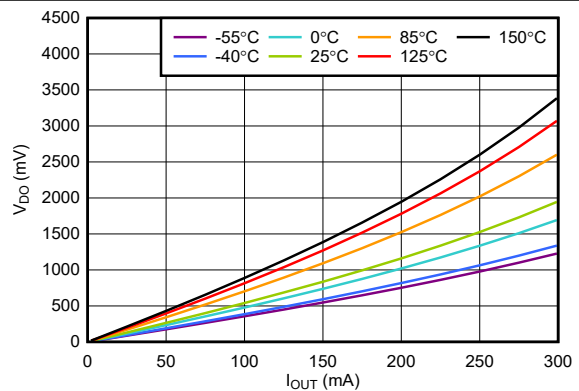

$V_{OUT} = 5.0\text{V}$

Figure 5-18. Dropout vs  $I_{OUT}$

## 5.6 Typical Characteristics (continued)

at operating junction temperature  $T_J = 25^\circ\text{C}$ ,  $V_{IN} = 2.5\text{V}$  or  $V_{IN} = V_{OUT}(\text{nom}) + 0.5\text{V}$  (whichever is greater),  $C_{IN} = 1\mu\text{F}$ ,  $C_{OUT} = 1\mu\text{F}$ , and  $I_{OUT} = 1\text{mA}$  (unless otherwise noted)

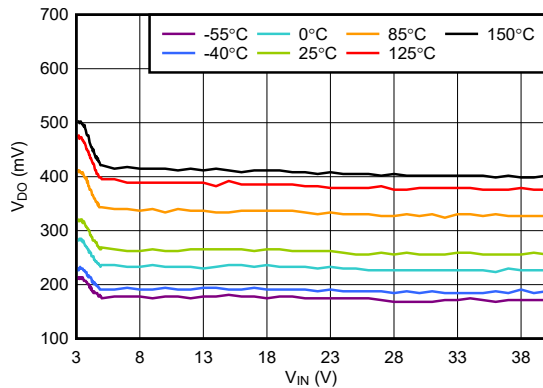

For adjustable configuration,  $I_{OUT} = 50\text{mA}$

**Figure 5-19. Dropout vs  $V_{IN}$**

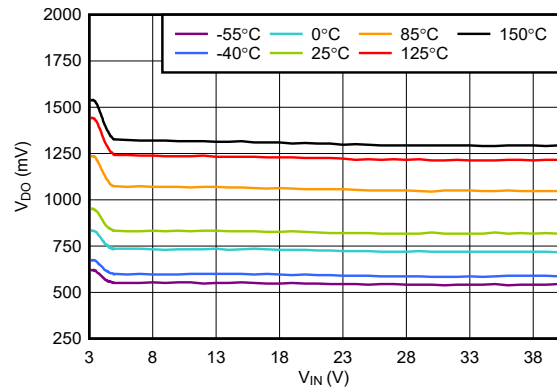

For adjustable configuration,  $I_{OUT} = 150\text{mA}$

**Figure 5-20. Dropout vs  $V_{IN}$**

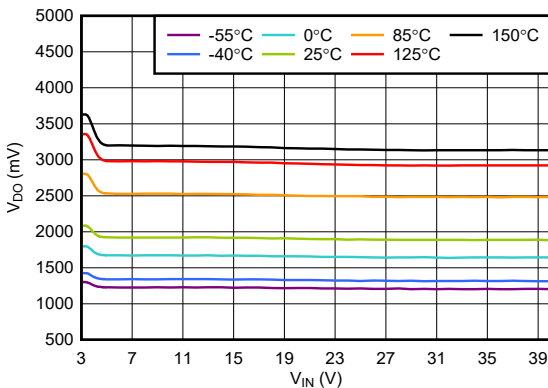

For adjustable configuration,  $I_{OUT} = 300\text{mA}$

**Figure 5-21. Dropout vs  $V_{IN}$**

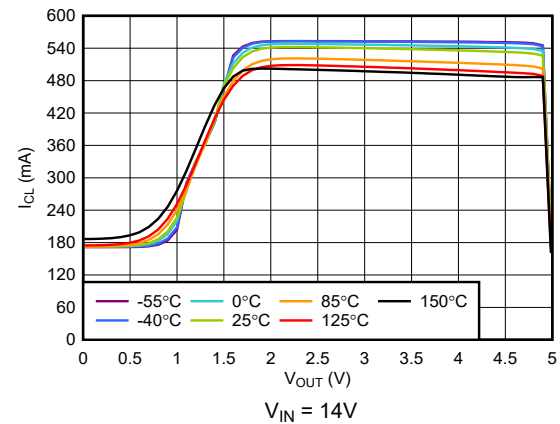

**Figure 5-22. Current Limit vs  $V_{OUT}$**

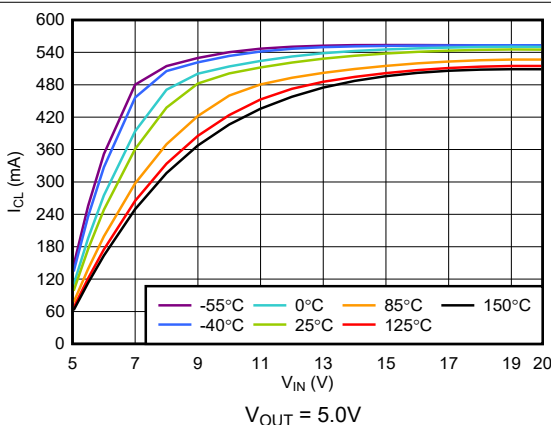

**Figure 5-23. Current Limit vs  $V_{IN}$**

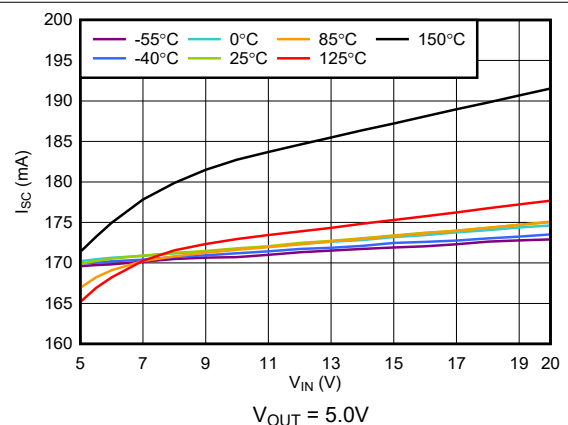

**Figure 5-24. Short-Current Limit vs  $V_{IN}$**

### 5.6 Typical Characteristics (continued)

at operating junction temperature  $T_J = 25^\circ\text{C}$ ,  $V_{IN} = 2.5\text{V}$  or  $V_{IN} = V_{OUT}(\text{nom}) + 0.5\text{V}$  (whichever is greater),  $C_{IN} = 1\mu\text{F}$ ,  $C_{OUT} = 1\mu\text{F}$ , and  $I_{OUT} = 1\text{mA}$  (unless otherwise noted)

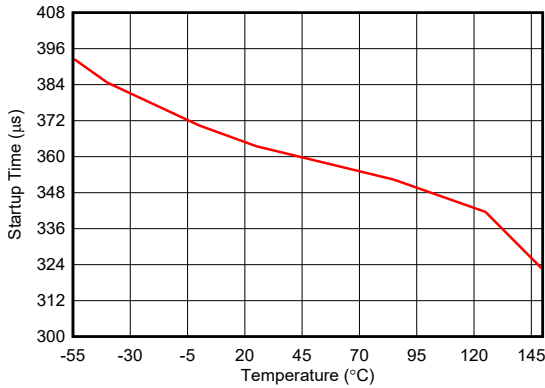

$V_{IN} = 5.5\text{V}$ ,  $V_{OUT} = 5.0\text{V}$

Figure 5-25. Start-Up Time vs Temperature

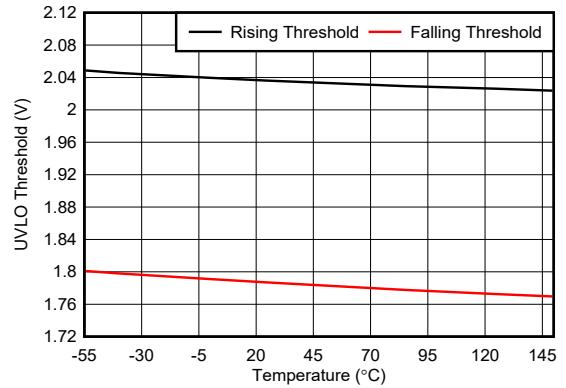
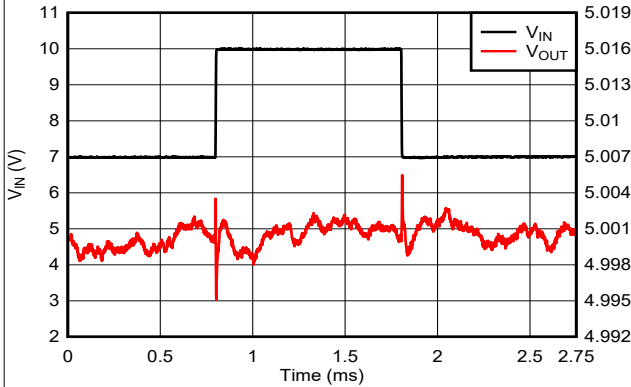
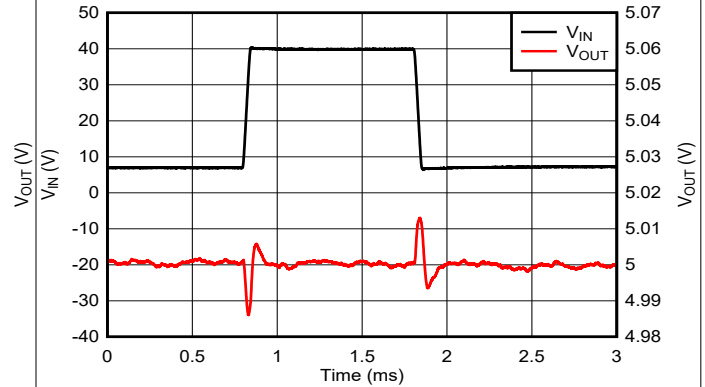

Figure 5-26. UVLO Thresholds vs Temperature



$V_{OUT} = 5.0\text{V}$ ,  $I_{OUT} = 150\text{mA}$ ,  $dV_{IN}/dt = 1\text{V}/\mu\text{s}$

Figure 5-27.  $V_{IN}$  Line Transient (7V to 10V)



$V_{OUT} = 5.0\text{V}$ ,  $I_{OUT} = 1\text{mA}$ ,  $dV_{IN}/dt = 1\text{V}/\mu\text{s}$

Figure 5-28.  $V_{IN}$  Line Transient (7V to 40V)

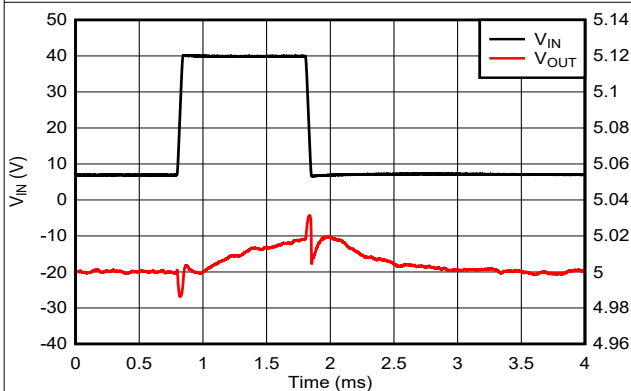

$V_{OUT} = 5.0\text{V}$ ,  $I_{OUT} = 150\text{mA}$ ,  $dV_{IN}/dt = 1\text{V}/\mu\text{s}$

Figure 5-29.  $V_{IN}$  Line Transient (7V to 40V)

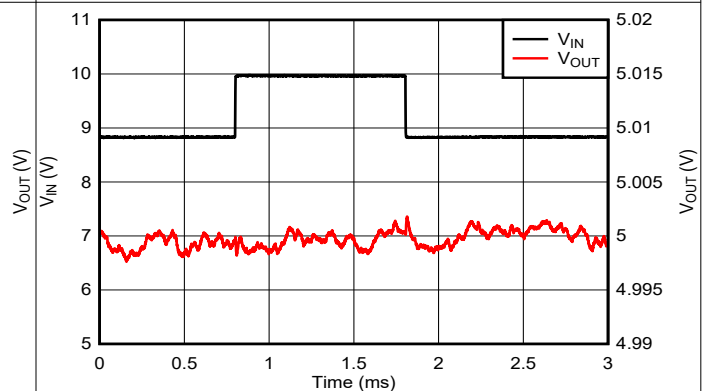

$V_{OUT} = 5.0\text{V}$ ,  $I_{OUT} = 1\text{mA}$ ,  $dV_{IN}/dt = 1\text{V}/\mu\text{s}$

Figure 5-30.  $V_{IN}$  Line Transient (8.8V to 10V)

## 5.6 Typical Characteristics (continued)

at operating junction temperature  $T_J = 25^\circ\text{C}$ ,  $V_{IN} = 2.5\text{V}$  or  $V_{IN} = V_{OUT}(\text{nom}) + 0.5\text{V}$  (whichever is greater),  $C_{IN} = 1\mu\text{F}$ ,  $C_{OUT} = 1\mu\text{F}$ , and  $I_{OUT} = 1\text{mA}$  (unless otherwise noted)

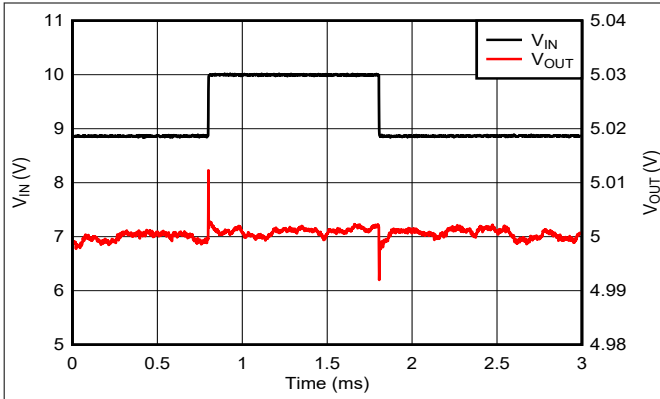

**Figure 5-31.  $V_{IN}$  Line Transient (8.8V to 10V)**

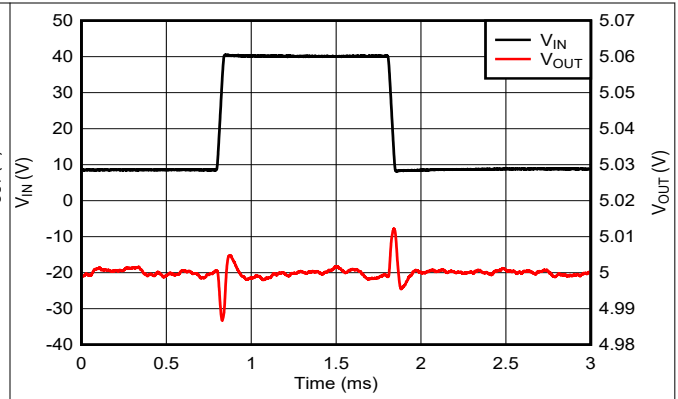

**Figure 5-32.  $V_{IN}$  Line Transient (8.8V to 40V)**

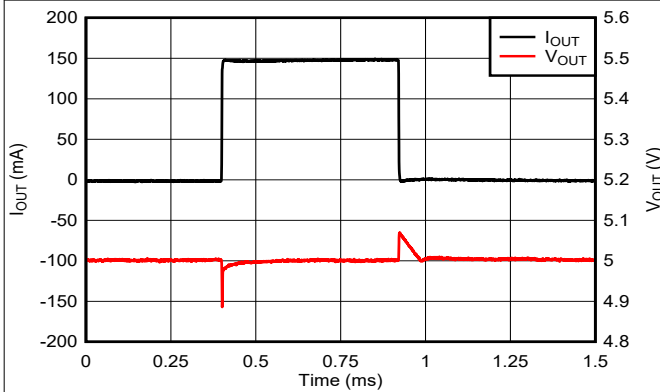

**Figure 5-33. Load Transient (1mA to 150mA)**

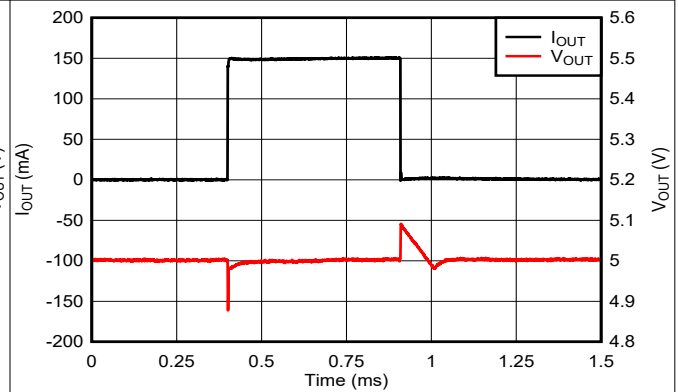

**Figure 5-34. Load Transient (1mA to 150mA)**

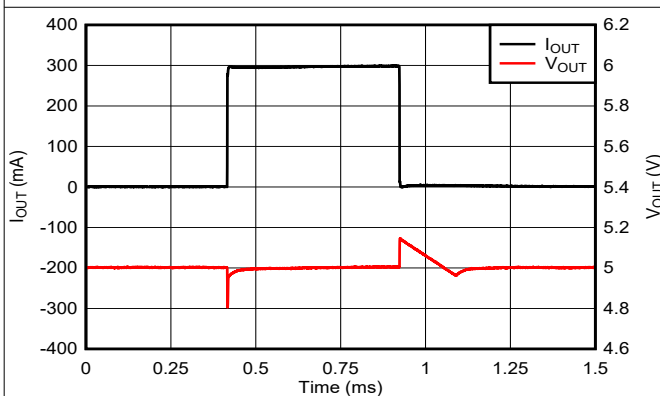

**Figure 5-35. Load Transient (1mA to 300mA)**

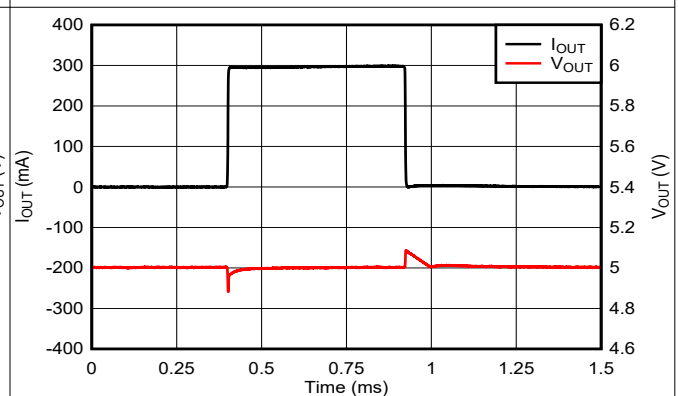

**Figure 5-36. Load Transient (1mA to 300mA)**

## 5.6 Typical Characteristics (continued)

at operating junction temperature  $T_J = 25^\circ\text{C}$ ,  $V_{IN} = 2.5\text{V}$  or  $V_{IN} = V_{OUT}(\text{nom}) + 0.5\text{V}$  (whichever is greater),  $C_{IN} = 1\mu\text{F}$ ,  $C_{OUT} = 1\mu\text{F}$ , and  $I_{OUT} = 1\text{mA}$  (unless otherwise noted)

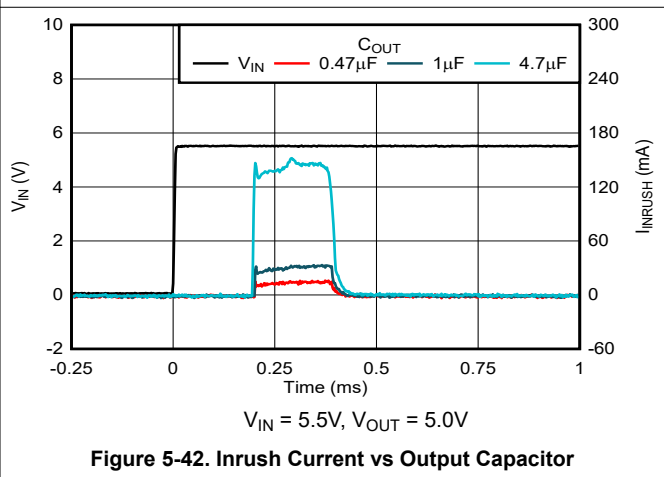
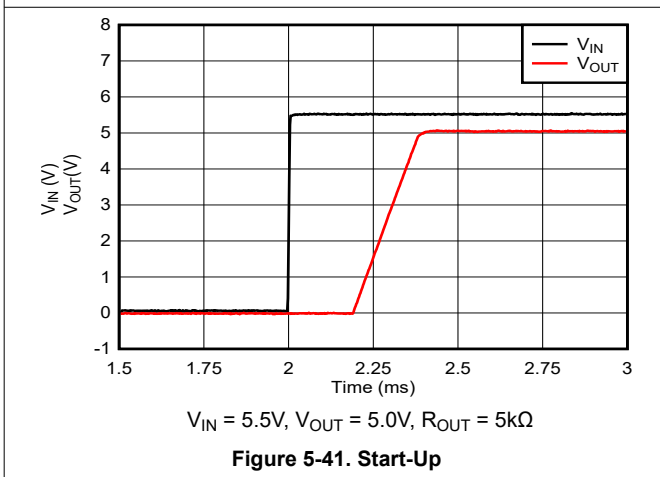
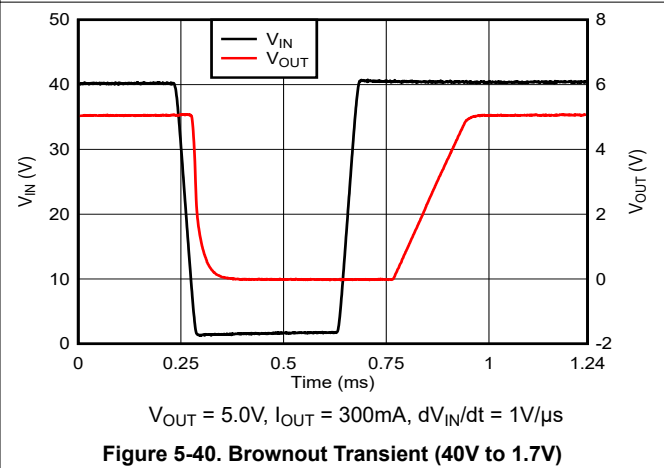
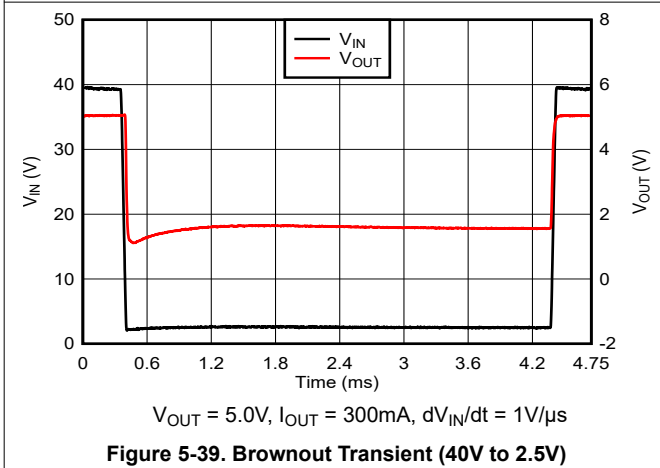
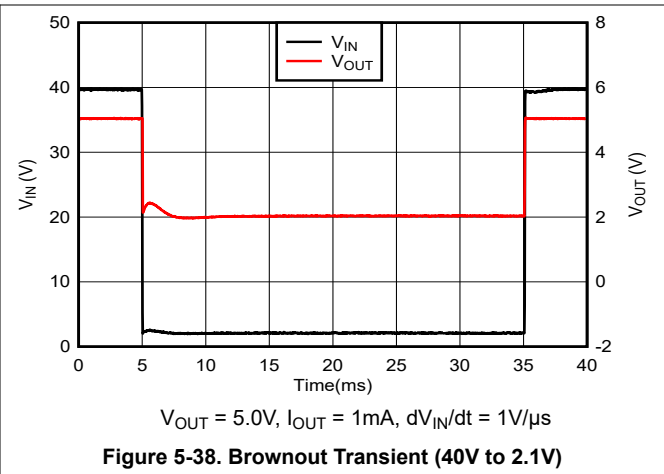
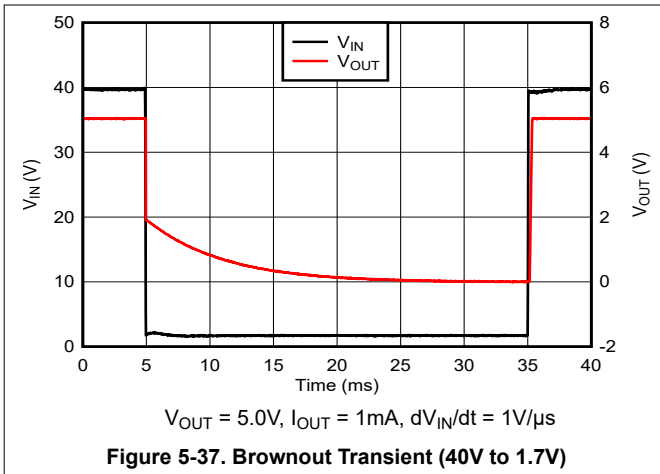

## 5.6 Typical Characteristics (continued)

at operating junction temperature  $T_J = 25^\circ\text{C}$ ,  $V_{IN} = 2.5\text{V}$  or  $V_{IN} = V_{OUT}(\text{nom}) + 0.5\text{V}$  (whichever is greater),  $C_{IN} = 1\mu\text{F}$ ,  $C_{OUT} = 1\mu\text{F}$ , and  $I_{OUT} = 1\text{mA}$  (unless otherwise noted)

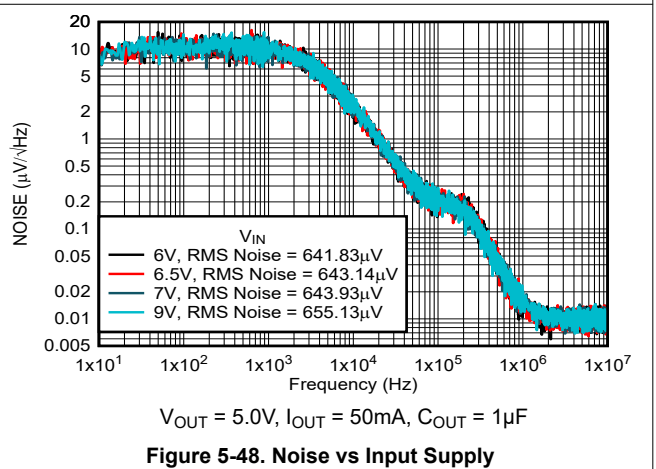
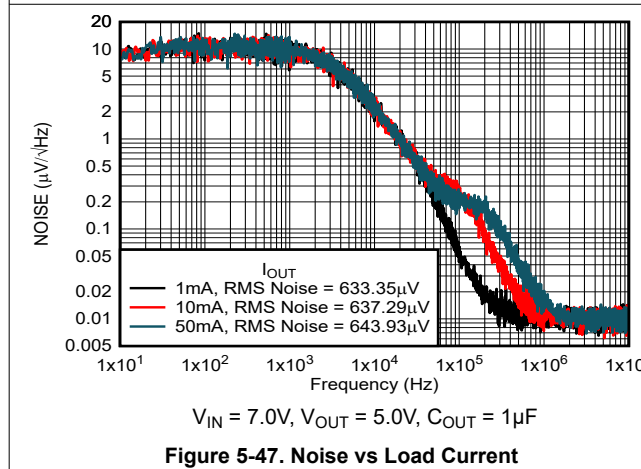
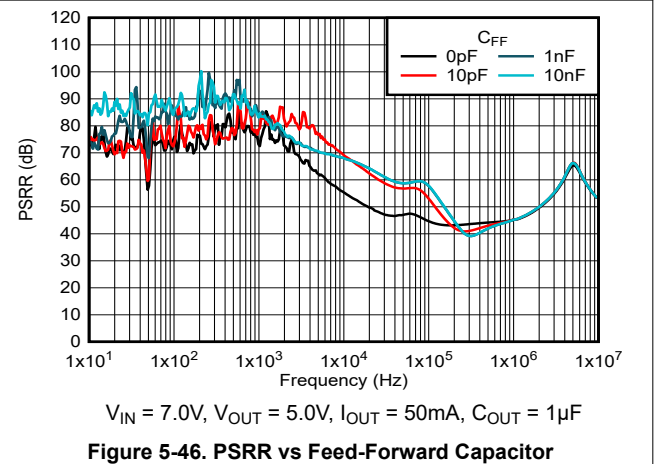
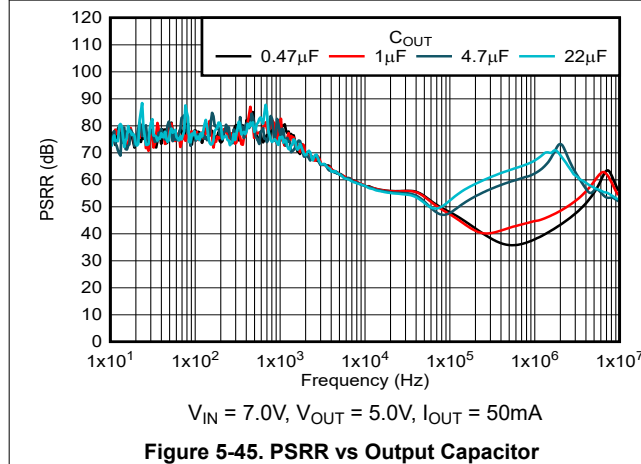
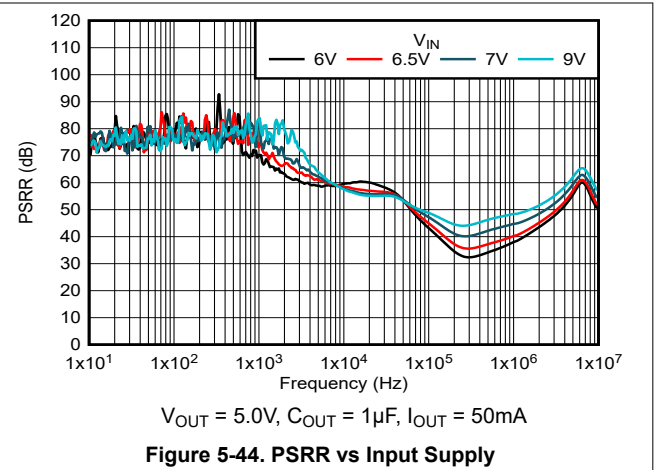
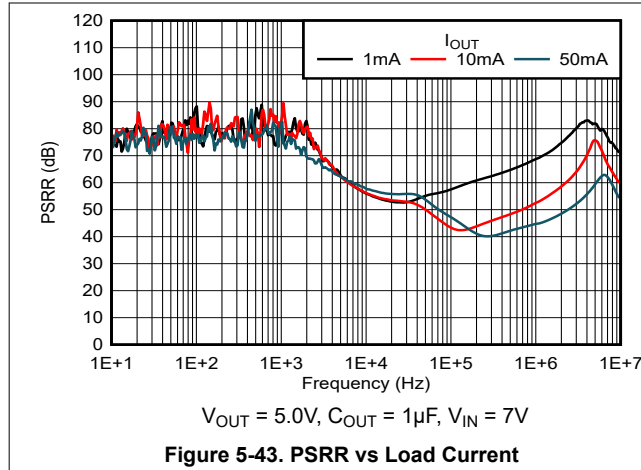

### 5.6 Typical Characteristics (continued)

at operating junction temperature  $T_J = 25^\circ\text{C}$ ,  $V_{IN} = 2.5\text{V}$  or  $V_{IN} = V_{OUT}(\text{nom}) + 0.5\text{V}$  (whichever is greater),  $C_{IN} = 1\mu\text{F}$ ,  $C_{OUT} = 1\mu\text{F}$ , and  $I_{OUT} = 1\text{mA}$  (unless otherwise noted)

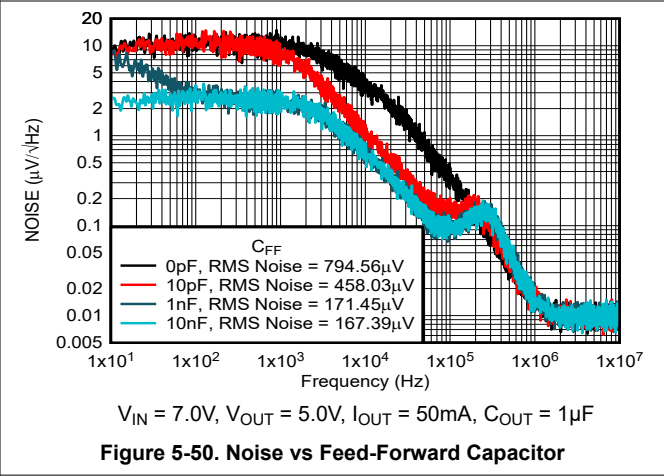
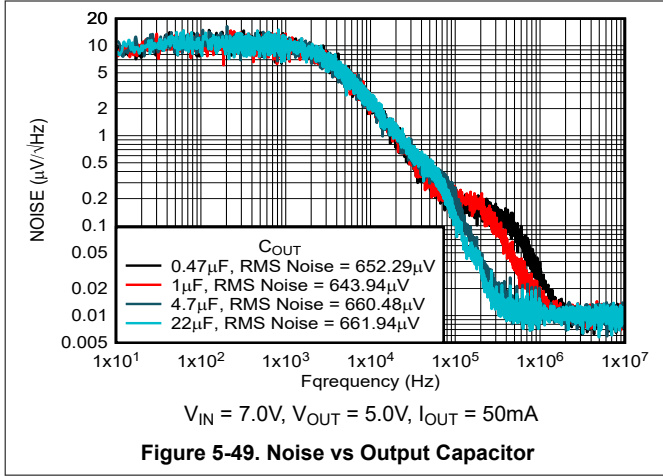

## 6 Detailed Description

### 6.1 Overview

The TPS7B92 low-dropout regulator (LDO) consumes only 1.8 $\mu$ A (typ) of quiescent current at no-load current. The device offers a wide input voltage range (2.5V to 40V) and wide output range in small packaging. The wide output range is from 1.2V to  $V_{IN} - V_{DO}$  for the adjustable output. The device is stable with the output capacitor range of 1 $\mu$ F to 47 $\mu$ F. The low quiescent current across the complete load current range makes the TPS7B92 designed for powering battery-operated applications. The TPS7B92 has an internal soft-start mechanism that provides a uniform start-up with controlled inrush current. This LDO also has fold-back overcurrent and thermal protection during a load-short or fault condition on the output.

### 6.2 Functional Block Diagrams

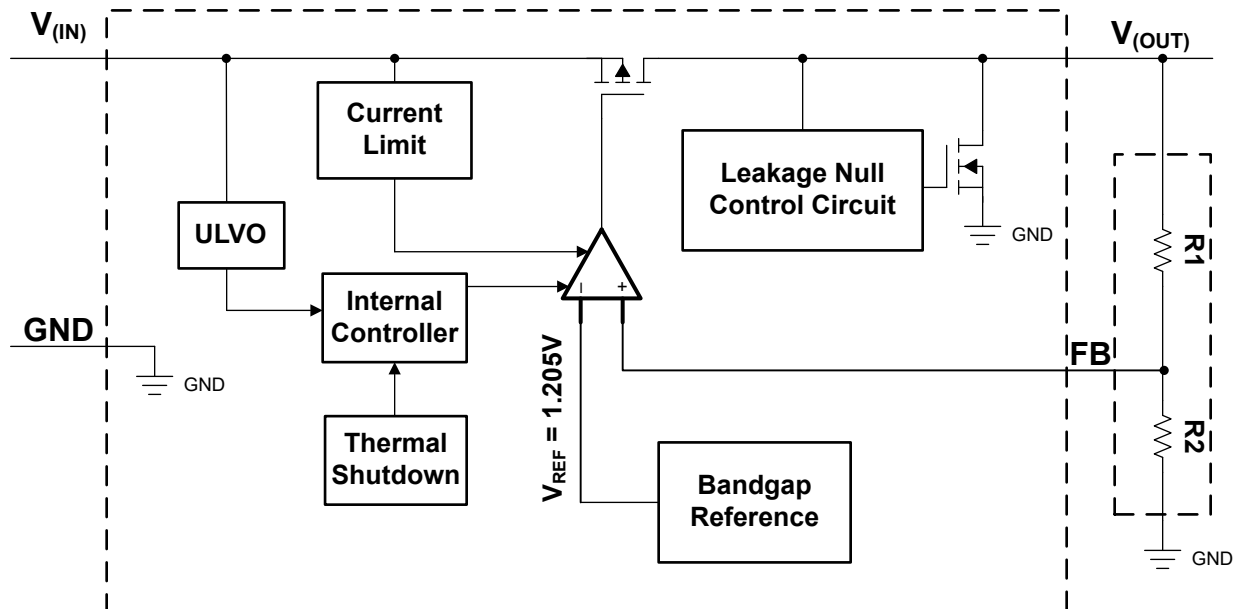

Figure 6-1. Functional Block Diagram: Adjustable Version

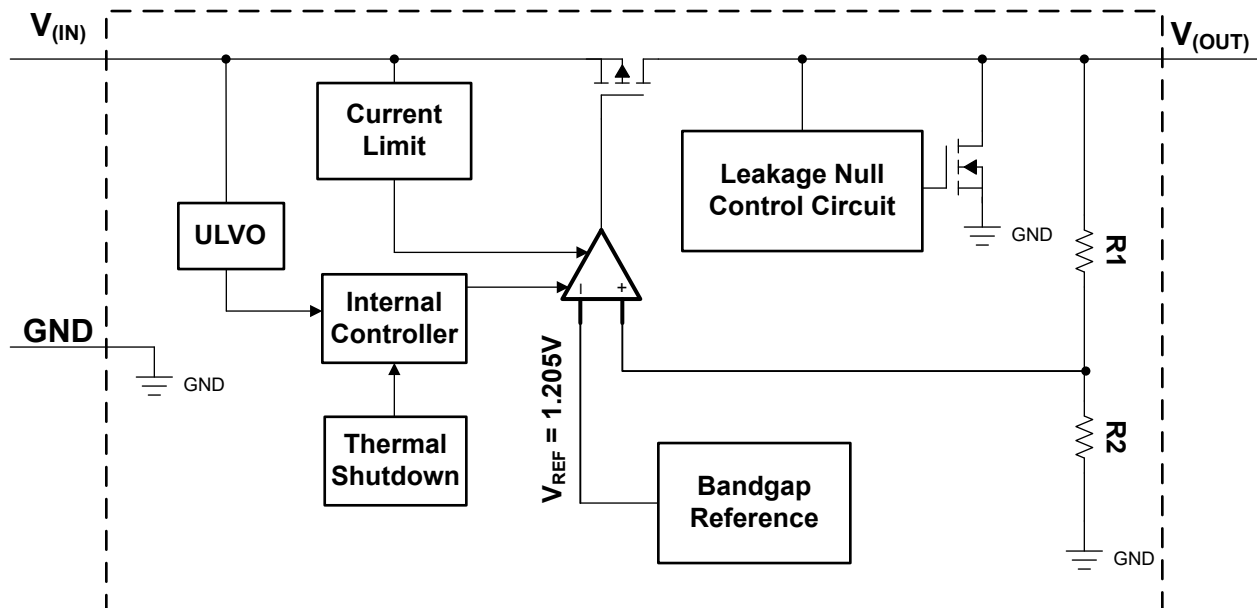

Figure 6-2. Functional Block Diagram: Fixed Version



## 6.3 Feature Description

### 6.3.1 Wide Supply Range

This device has an operational input supply range of 2.5V to 40V, allowing for a wide range of applications. This wide supply range is designed for applications that have either large transients or high DC voltage supplies.

### 6.3.2 Low Quiescent Current

This device only requires 1.8μA (typical) of quiescent current at no load. The LDO consumes less than 0.1% of the full load current capacity (300mA) at room temperature. For load currents higher than 1mA, the TPS7B92 manages the  $I_Q$  consumption to be less than 0.5% of the load current to maintain high efficiency. In this manner, the device maintains good transient performance.

### 6.3.3 Dropout Voltage ( $V_{DO}$ )

Dropout voltage ( $V_{DO}$ ) is defined as  $V_{IN} - V_{OUT}$  at the rated output current ( $I_{RATED}$ ), where the pass transistor is fully on.  $V_{IN} - V_{OUT}$  is input voltage minus the output voltage.  $I_{RATED}$  is the maximum  $I_{OUT}$  listed in the [Recommended Operating Conditions](#) table. In dropout operation, the pass transistor is in the ohmic or triode region of operation, and acts as a switch. Dropout voltage indirectly specifies a minimum input voltage greater than the nominal programmed output voltage where the output voltage is expected to stay in regulation. If the input voltage falls to less than the value required to maintain output regulation, then the output voltage falls as well.

For a CMOS regulator, the dropout voltage is determined by the drain-source, on-state resistance ( $R_{DS(ON)}$ ) of the pass transistor. Therefore, if the linear regulator operates at less than the rated current, the dropout voltage for that current scales accordingly. [Equation 1](#) calculates the  $R_{DS(ON)}$  of the device.

$$R_{DS(ON)} = \frac{V_{DO}}{I_{RATED}} \quad (1)$$

### 6.3.4 Current Limit

The device has an internal current limit circuit that protects the regulator during transient high-load current faults or shorting events. The current limit is a hybrid brick-wall-foldback scheme. The current limit transitions from a brick-wall scheme to a foldback scheme at the foldback voltage ( $V_{FOLDBACK}$ ). In a high-load current fault with the output voltage above  $V_{FOLDBACK}$ , the brick-wall scheme limits the output current to the current limit ( $I_{CL}$ ). When the voltage drops below  $V_{FOLDBACK}$ , a foldback current limit activates that scales back the current as the output voltage approaches GND. When the output is shorted, the device supplies a typical current called the short-circuit current limit ( $I_{SC}$ ).  $I_{CL}$  and  $I_{SC}$  are listed in the [Electrical Characteristics](#) table.

For this device,  $V_{FOLDBACK} = 50\% \times V_{OUT(nom)}$ .

The output voltage is not regulated when the device is in current limit. When a current limit event occurs, the device begins to heat up because of the increase in power dissipation. When the device is in brick-wall current limit, the pass transistor dissipates power  $[(V_{IN} - V_{OUT}) \times I_{CL}]$ . When the device output is shorted and the output is below  $V_{FOLDBACK}$ , the pass transistor dissipates power  $[(V_{IN} - V_{OUT}) \times I_{SC}]$ . If thermal shutdown is triggered, the device turns off. After the device cools down, the internal thermal shutdown circuit turns the device back on. If the output current fault condition continues, the device cycles between current limit and thermal shutdown. For more information on current limits, see the [Know Your Limits application note](#).

Figure 6-3 shows a diagram of the foldback current limit.

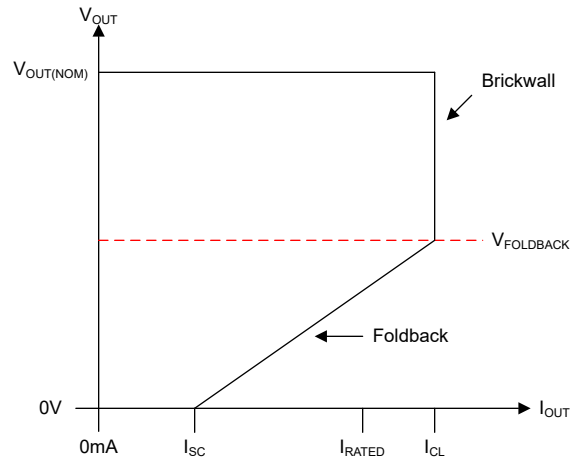

**Figure 6-3. Foldback Current Limit**

### 6.3.5 Leakage Null Control Circuit

This device has a built-in, leakage-null control circuit. At high temperatures, pass-transistor leakage increases and starts impacting the  $V_{OUT}$  accuracy at low-load conditions. This leakage becomes more aggravated with higher headroom across the LDO ( $V_{IN} - V_{OUT}$ ). The TPS7B92 has a built-in, leakage-null control circuit that detects pass-transistor leakage and provides a ground discharge path for the leakage. This circuitry helps the TPS7B92 maintain much tighter  $V_{OUT}$  accuracy across wide  $V_{IN}$  and temperature ( $-40^{\circ}\text{C}$  to  $+125^{\circ}\text{C}$ ) ranges.

## 6.4 Device Functional Modes

Table 6-1 provides a quick comparison between the normal and dropout modes of operation.

**Table 6-1. Device Functional Mode Comparison**

OPERATING MODE	PARAMETER	
	$V_{IN}$	$I_{OUT}$
Normal	$V_{IN} > V_{OUT(nom)} + V_{DO}$	$I_{OUT} < I_{CL}$
Dropout	$V_{IN} < V_{OUT(nom)} + V_{DO}$	$I_{OUT} < I_{CL}$

### 6.4.1 Normal Operation

The device regulates to the nominal output voltage under the following conditions:

- The input voltage is greater than the nominal output voltage plus the dropout voltage ( $V_{OUT(nom)} + V_{DO}$ )
- The output current is less than the current limit ( $I_{OUT} < I_{CL}$ )
- The device junction temperature is greater than  $-40^{\circ}\text{C}$  and less than  $+125^{\circ}\text{C}$

### 6.4.2 Dropout Operation

The device operates in dropout mode when the input voltage is lower than the nominal output voltage plus the specified dropout voltage. However, make sure all other conditions are met for normal operation. In dropout operation, the pass transistor is in the ohmic or triode region of operation, and acts as a switch. Because of this operation, the transient performance of the device becomes significantly degraded. Line or load transients in dropout potentially result in large output voltage deviations.

When the device is in a steady dropout state, the pass transistor is driven into the ohmic or triode region. This state is defined as when the device is in dropout, directly after being in a normal regulation state, but *not* during start up. During dropout,  $V_{IN} < V_{OUT(NOM)} + V_{DO}$ . When the input voltage returns to a value  $\geq V_{OUT(NOM)} + V_{DO}$ , the output voltage overshoots for a short period of time. During this time, the device pulls the pass transistor back into the linear region.  $V_{OUT(NOM)}$  is the nominal output voltage and  $V_{DO}$  is the dropout voltage.

## 7 Application and Implementation

### Note

Information in the following applications sections is not part of the TI component specification, and TI does not warrant its accuracy or completeness. TI's customers are responsible for determining suitability of components for their purposes, as well as validating and testing their design implementation to confirm system functionality.

### 7.1 Application Information

The TPS7B92 LDO regulator is a good choice for battery-powered applications. The device is a good supply for low-power microcontrollers, such as the [MSP430](#), because of the device low  $I_Q$  performance across load current range. The ultra-low-supply current of the TPS7B92 maximizes efficiency at light loads. The device features flexibility in the output voltage selection for the adjustable configuration and fixed output levels. These features and the high input voltage range makes the device optimal as a supply in building automation and power tools.

### 7.2 Typical Application

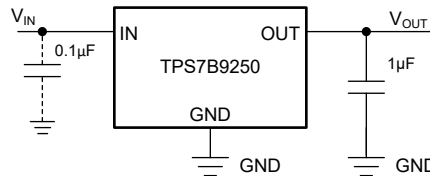

Figure 7-1. Typical Application Circuit (Fixed-Voltage Version)

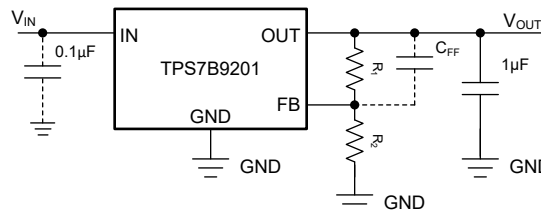

Figure 7-2. TPS7B9201 Adjustable LDO Regulator Programming

NOTE: Dotted lines indicate an optional input capacitor and feed-forward capacitor. See the [Input and Output Capacitor Requirements](#) and [Feed-Forward Capacitor \( \$C\_{FF}\$ \)](#) sections and the [Recommended Operating Conditions](#) table.

Table 7-1. Adjustable Output Voltage for Resistors  $R_1$  and  $R_2$

OUTPUT VOLTAGE (V)	$R_1$ (M $\Omega$ )	$R_2$ (M $\Omega$ )
1.8	0.499	1
2.8	1.33	1
5.0	3.16	1

#### 7.2.1 Design Requirements

Table 7-2 summarizes the design requirements for [Figure 7-1](#).

Table 7-2. Design Parameters

PARAMETER	DESIGN REQUIREMENT
Input voltage	12V
Output voltage	5.0V
Output current	100mA

## 7.2.2 Detailed Design Procedure

### 7.2.2.1 Setting $V_{OUT}$ for the TPS7B9201 Adjustable LDO

As illustrated in [Figure 7-2](#), the TPS7B92 contains an adjustable version (the TPS7B9201) that sets the output voltage using an external resistor divider. The output voltage operating range is 1.205V to  $V_{IN} - V_{DO}$ , and is calculated using:

$$V_{OUT} = V_{REF} \times \left(1 + \frac{R_1}{R_2}\right) \quad (2)$$

where:

- $V_{REF} = 1.205\text{V}$  (typical)

Choose resistors  $R_1$  and  $R_2$  to allow approximately 1.5 $\mu\text{A}$  of current through the resistor divider. To ignore the FB pin current error term in the  $V_{OUT}$  equation, set the feedback divider current to 15 times the FB pin current listed in the [Electrical Characteristics](#) table. Using lower value resistors improves noise performance, but consumes more power. Avoid higher resistor values. Leakage current into or out of FB across  $R_1 / R_2$  creates an offset voltage proportional to  $V_{OUT}$  divided by  $V_{REF}$ . Choose  $R_2 = 1\text{M}\Omega$  to set the divider current at 1.205 $\mu\text{A}$ . [Equation 3](#) calculates  $R_1$ . [Figure 7-2](#) depicts this configuration.

$$R_1 = \left(\frac{V_{OUT}}{V_{REF}} - 1\right) \times R_2 \quad (3)$$

To understand more about the impact of feedback divider current on the output accuracy, see the [I<sub>Q</sub> vs Accuracy Tradeoff in Designing Resistor Divider](#) application note.

### 7.2.2.2 External Capacitor Requirements

The device is designed to be stable using low equivalent series resistance (ESR) ceramic capacitors at the input and output. Multilayer ceramic capacitors have become the industry standard for these types of applications and are recommended, but use good judgment. Ceramic capacitors that employ X7R-, X5R-, and C0G-rated dielectric materials provide relatively good capacitive stability across temperature. However, using Y5V-rated capacitors is discouraged because of large variations in capacitance.

Regardless of the ceramic capacitor type selected, the effective capacitance varies with operating voltage and temperature. Generally, expect the effective capacitance to decrease by as much as 50%. The input and output capacitors listed in the [Recommended Operating Conditions](#) table account for an effective capacitance of approximately 50% of the nominal value.

### 7.2.2.3 Input and Output Capacitor Requirements

Although an input capacitor is not required for stability, good analog design practice is to connect a capacitor from IN to GND. This capacitor counteracts reactive input sources and improves transient response, input ripple, and PSRR. Use an input capacitor if the source impedance is more than 0.5 $\Omega$ . A higher value capacitor is necessary if large, fast rise-time load or line transients are anticipated. A higher value capacitor is also required if the device is located several inches from the input power source.

Dynamic performance of the device is improved by using a larger output capacitor. The TPS7B92 requires an output capacitor of 1 $\mu\text{F}$  or larger (0.47 $\mu\text{F}$  or larger capacitance) for stability. An equivalent series resistance (ESR) between 0.001 $\Omega$  and 1 $\Omega$  is also required. For best transient performance, use X5R- and X7R-type ceramic capacitors because these capacitors have minimal variation in value and ESR over temperature. When choosing a capacitor for a specific application, be mindful of the DC bias characteristics for the capacitor. Higher output voltages cause a significant derating of the capacitor. Use an output capacitor within the range specified in the [Recommended Operating Conditions](#) table for stability.

### 7.2.2.4 Reverse Current

Excessive reverse current potentially damages this device. Reverse current flows through the intrinsic body diode of the PMOS pass transistor instead of the normal conducting channel. At high magnitudes, this current flow degrades the long-term reliability of the device.

Conditions where reverse current occur are outlined in this section, all of which exceed the absolute maximum rating of  $V_{OUT} \leq V_{IN} + 0.3V$ . These conditions are:

- If the device has a large  $C_{OUT}$  and the input supply collapses with little or no load current
- The output is biased when the input supply is not established
- The output is biased above the input supply

If reverse current flow is expected in the application, use external protection to protect the device. Reverse current is not limited in the device, so external limiting is required if extended reverse voltage operation is anticipated. Limit reverse current to 5% or less of the rated output current of the device in the event this current cannot be avoided.

Figure 7-3 shows one approach for protecting the device.

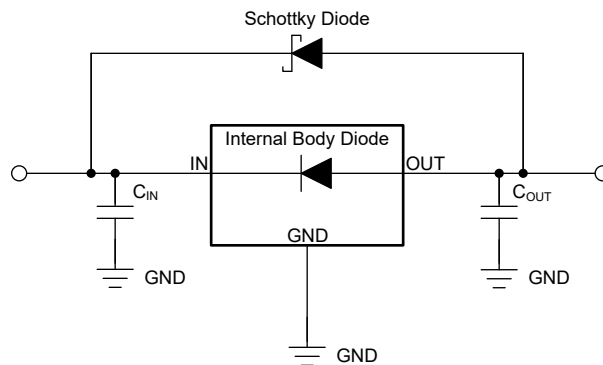

**Figure 7-3. Example Circuit for Reverse Current Protection Using a Schottky Diode**

### 7.2.2.5 Feed-Forward Capacitor ( $C_{FF}$ )

For the adjustable-voltage version device, connect a feed-forward capacitor ( $C_{FF}$ ) from the OUT pin to the FB pin.  $C_{FF}$  improves transient, noise, and PSRR performance, but is not required for regulator stability. Recommended  $C_{FF}$  values are listed in the [Recommended Operating Conditions](#) table. Using a higher capacitance  $C_{FF}$  causes the start-up time to increase. For a detailed description of  $C_{FF}$  tradeoffs, see the [Pros and Cons of Using a Feedforward Capacitor with a Low-Dropout Regulator](#) application note.

$C_{FF}$  and  $R_1$  form a zero in the loop gain at frequency  $f_z$ .  $C_{FF}$ ,  $R_1$ , and  $R_2$  form a pole in the loop gain at frequency  $f_p$ . Calculate the  $C_{FF}$  zero and pole frequencies from the following equations:

$$f_z = 1 / (2 \times \pi \times C_{FF} \times R_1) \quad (4)$$

$$f_p = 1 / (2 \times \pi \times C_{FF} \times (R_1 \parallel R_2)) \quad (5)$$

$C_{FF} \geq 10pF$  is required for stability if the feedback divider current is less than  $5\mu A$ . Equation 6 calculates the feedback divider current.

$$I_{FB\_Divider} = V_{OUT} / (R_1 + R_2) \quad (6)$$

To avoid the start-up time increasing from  $C_{FF}$ , limit the product of  $C_{FF} \times R_1 < 50\mu s$ .

For an output voltage of 1.205V with the FB pin tied to the OUT pin, do not use  $C_{FF}$ .

### 7.2.2.6 Power Dissipation ( $P_D$ )

Circuit reliability requires consideration of the device power dissipation, circuit location on the printed circuit board (PCB), and correct sizing of the thermal plane. Make sure the PCB area around the regulator has few or no other heat-generating devices that cause added thermal stress.

To first-order approximation, power dissipation in the regulator depends on the input-to-output voltage difference and load conditions. The following equation calculates power dissipation ( $P_D$ ).

$$P_D = (V_{IN} - V_{OUT}) \times I_{OUT} \quad (7)$$

#### Note

Power dissipation is minimized, and therefore greater efficiency achieved, by correct selection of the system voltage rails. For the lowest power dissipation, use the minimum input voltage required for correct output regulation.

For devices with a thermal pad, the primary heat conduction path for the device package is through the thermal pad to the PCB. Solder the thermal pad to a copper pad area under the device. Make sure this pad area contains an array of plated vias that conduct heat to additional copper planes for increased heat dissipation.

The maximum power dissipation determines the maximum allowable ambient temperature ( $T_A$ ) for the device. According to [Equation 8](#), power dissipation and junction temperature are most often related by the junction-to-ambient thermal resistance ( $R_{\theta JA}$ ). The  $R_{\theta JA}$  component is the combined PCB, device package, and the temperature of the ambient air ( $T_A$ ).

$$T_J = T_A + (R_{\theta JA} \times P_D) \quad (8)$$

The maximum peak power dissipation supported for the TPS7B92 is defined in the [Absolute Maximum Ratings](#). The power dissipation ratings are recorded for the PCB configurations and are based on a JEDEC standard of 2s2p configuration (EIA/JESD51-x). The maximum supported power provides reliable operation for the TPS7B92. Exceeding the power limits leads to extreme junction temperatures (related to junction-to-ambient thermal resistance  $R_{\theta JA}$ , [Equation 8](#)). Extreme temperatures risk damage to the device, and potentially reduces the expected device lifetime. Based on the safe operating limits, [Figure 7-4](#) shows the supported load current ( $I_{OUT}$ ) for a headroom ( $V_{IN} - V_{OUT}$ ).

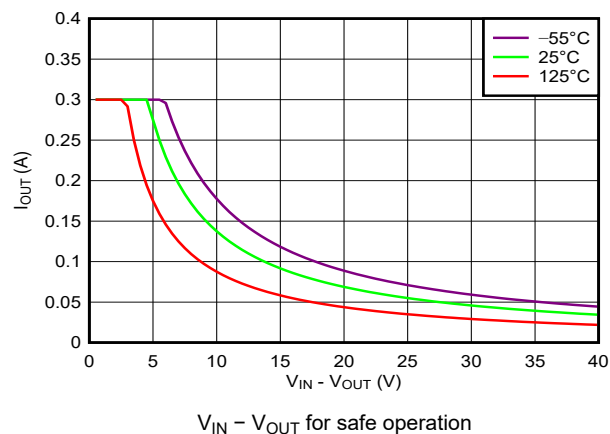

**Figure 7-4.  $I_{OUT}$  vs Headroom ( $V_{IN} - V_{OUT}$ )**

Thermal resistance ( $R_{\theta JA}$ ) is highly dependent on the heat-spreading capability built into the particular PCB design. Therefore,  $R_{\theta JA}$  varies according to the total copper area, copper weight, and location of the planes. The junction-to-ambient thermal resistance listed in the *Thermal Information* table is determined by the JEDEC standard PCB and copper-spreading area.  $R_{\theta JA}$  is used as a relative measure of package thermal performance.

$R_{\theta JA}$  is improved by 35% to 55% compared to the *Thermal Information* table value with the PCB board layout optimized. See the [An empirical analysis of the impact of board layout on LDO thermal performance application note](#).

### 7.2.2.7 Estimating Junction Temperature

The JEDEC standard now recommends using psi ( $\Psi$ ) thermal metrics to estimate the junction temperatures of the LDO when in-circuit on a typical PCB board application. These metrics are not thermal resistance parameters and instead offer a practical and relative way to estimate junction temperature. These psi metrics are determined to be significantly independent of the copper area available for heat-spreading. The *Thermal Information* table lists the primary thermal metrics, which are the junction-to-top characterization parameter ( $\psi_{JT}$ ) and junction-to-board characterization parameter ( $\psi_{JB}$ ). These parameters provide two methods for calculating the junction temperature ( $T_J$ ), as described in the following equations. Use the junction-to-top characterization parameter ( $\psi_{JT}$ ) with the temperature at the center-top of device package ( $T_T$ ) to calculate the junction temperature. Use the junction-to-board characterization parameter ( $\psi_{JB}$ ) with the PCB surface temperature 1mm from the device package ( $T_B$ ) to calculate the junction temperature.

$$T_J = T_T + \psi_{JT} \times P_D \quad (9)$$

where:

- $P_D$  is the dissipated power
- $T_T$  is the temperature at the center-top of the device package

$$T_J = T_B + \psi_{JB} \times P_D \quad (10)$$

where:

- $T_B$  is the PCB surface temperature measured 1mm from the device package and centered on the package edge

For detailed information on the thermal metrics and how to use them, see [Semiconductor and IC Package Thermal Metrics application note](#).

### 7.2.3 Application Curves

at operating temperature  $T_J = 25^\circ\text{C}$ ,  $V_{IN} = V_{OUT(NOM)} + 0.5\text{V}$  or  $2.5\text{V}$  (whichever is greater),  $I_{OUT} = 1\text{mA}$ ,  $C_{IN} = 1\mu\text{F}$ , and  $C_{OUT} = 1\mu\text{F}$  (unless otherwise noted)

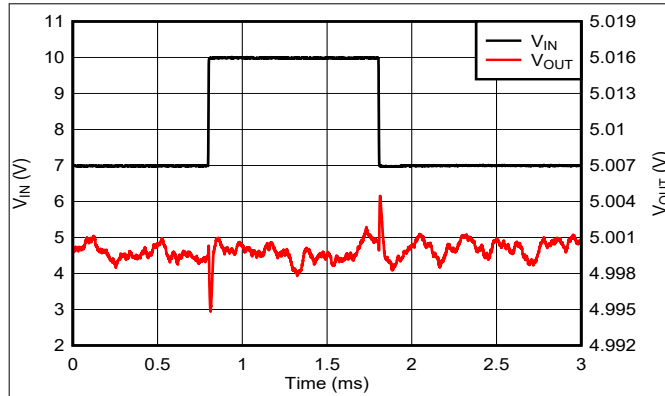

$V_{OUT} = 5.0\text{V}$ ,  $I_{OUT} = 1\text{mA}$ ,  $dV_{IN}/dt = 1\text{V}/\mu\text{s}$   
**Figure 7-5.  $V_{IN}$  Line Transient (7V to 10V)**

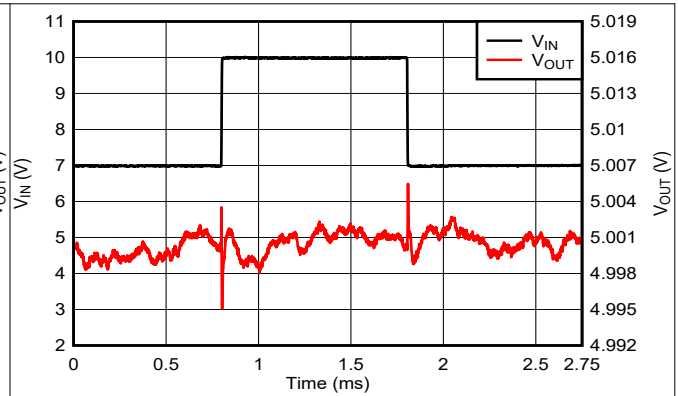

$V_{OUT} = 5.0\text{V}$ ,  $I_{OUT} = 150\text{mA}$ ,  $dV_{IN}/dt = 1\text{V}/\mu\text{s}$   
**Figure 7-6.  $V_{IN}$  Line Transient (7V to 10V)**

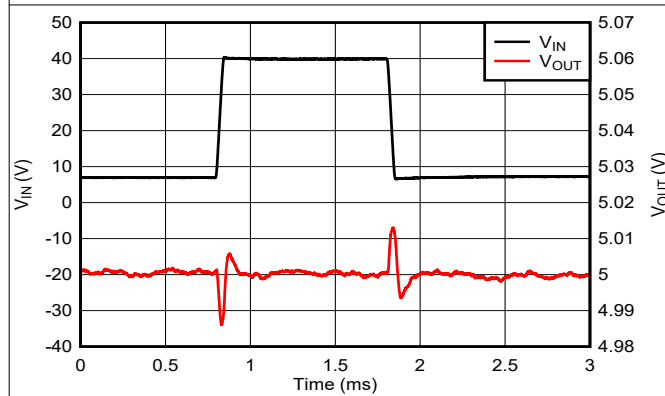

$V_{OUT} = 5.0\text{V}$ ,  $I_{OUT} = 1\text{mA}$ ,  $dV_{IN}/dt = 1\text{V}/\mu\text{s}$   
**Figure 7-7.  $V_{IN}$  Line Transient (7V to 40V)**

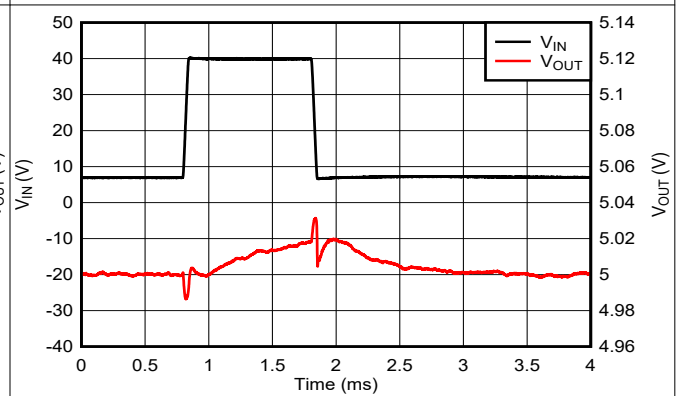

$V_{OUT} = 5.0\text{V}$ ,  $I_{OUT} = 150\text{mA}$ ,  $dV_{IN}/dt = 1\text{V}/\mu\text{s}$   
**Figure 7-8.  $V_{IN}$  Line Transient (7V to 40V)**

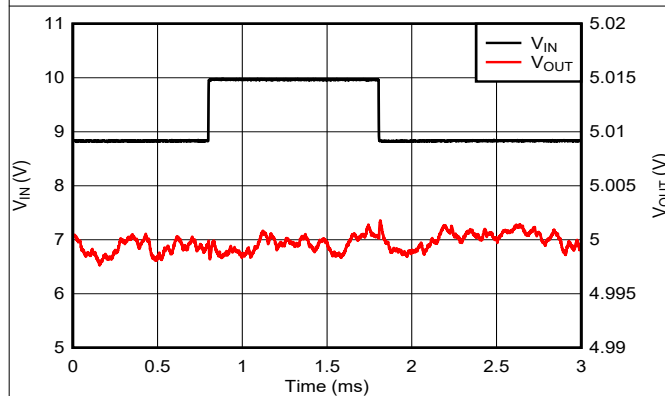

$V_{OUT} = 5.0\text{V}$ ,  $I_{OUT} = 1\text{mA}$ ,  $dV_{IN}/dt = 1\text{V}/\mu\text{s}$   
**Figure 7-9.  $V_{IN}$  Line Transient (8.8V to 10V)**

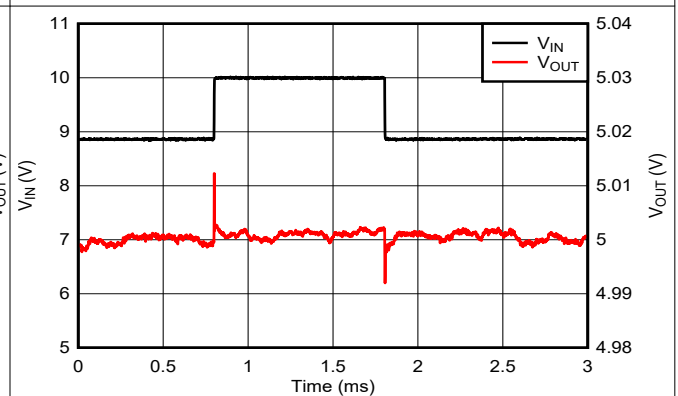

$V_{OUT} = 5.0\text{V}$ ,  $I_{OUT} = 300\text{mA}$ ,  $dV_{IN}/dt = 1\text{V}/\mu\text{s}$   
**Figure 7-10.  $V_{IN}$  Line Transient (8.8V to 10V)**



### 7.2.3 Application Curves (continued)

at operating temperature  $T_J = 25^\circ\text{C}$ ,  $V_{IN} = V_{OUT(NOM)} + 0.5\text{V}$  or  $2.5\text{V}$  (whichever is greater),  $I_{OUT} = 1\text{mA}$ ,  $C_{IN} = 1\mu\text{F}$ , and  $C_{OUT} = 1\mu\text{F}$  (unless otherwise noted)

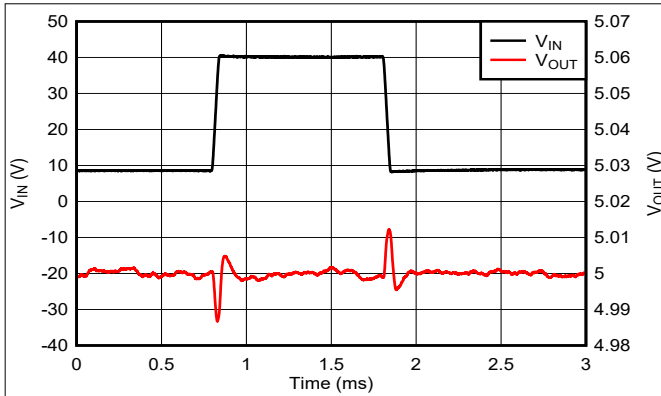

$V_{OUT} = 5.0\text{V}$ ,  $I_{OUT} = 1\text{mA}$ ,  $dV_{IN}/dt = 1\text{V}/\mu\text{s}$

Figure 7-11.  $V_{IN}$  Line Transient (8.8V to 40V)

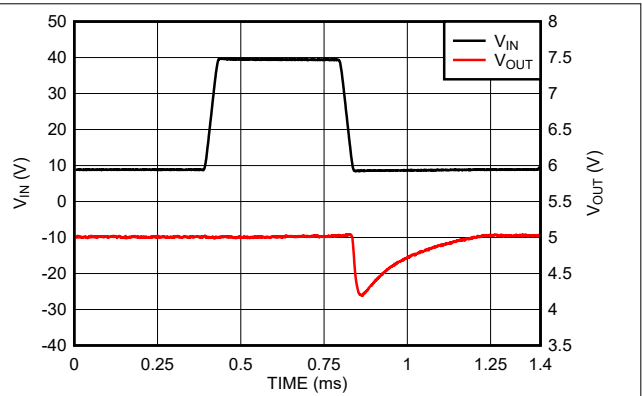

$V_{OUT} = 5.0\text{V}$ ,  $I_{OUT} = 300\text{mA}$ ,  $dV_{IN}/dt = 1\text{V}/\mu\text{s}$

Figure 7-12.  $V_{IN}$  Line Transient (8.8V to 40V)

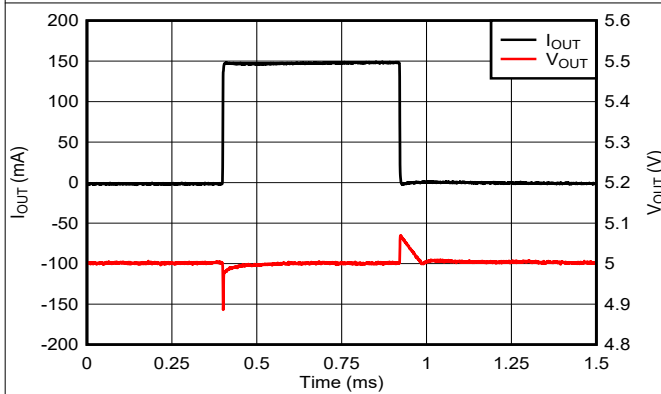

$V_{IN} = 7.0\text{V}$ ,  $V_{OUT} = 5.0\text{V}$ ,  $dI_{OUT}/dt = 0.1\text{A}/\mu\text{s}$

Figure 7-13. Load Transient (1mA to 150mA)

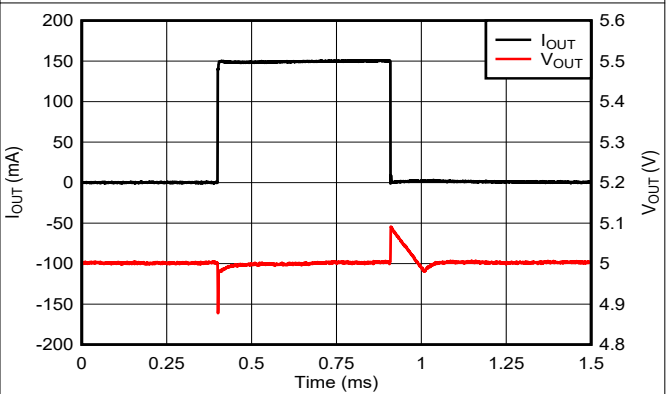

$V_{IN} = 7.0\text{V}$ ,  $V_{OUT} = 5.0\text{V}$ ,  $dI_{OUT}/dt = 1\text{A}/\mu\text{s}$

Figure 7-14. Load Transient (1mA to 150mA)

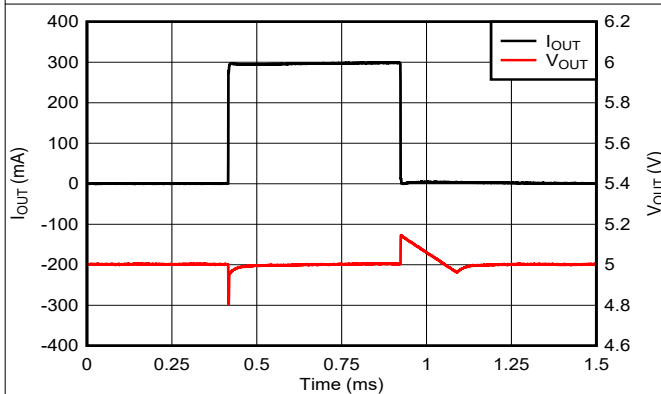

$V_{IN} = 8.8\text{V}$ ,  $V_{OUT} = 5.0\text{V}$ ,  $dI_{OUT}/dt = 1\text{A}/\mu\text{s}$

Figure 7-15. Load Transient (1mA to 300mA)

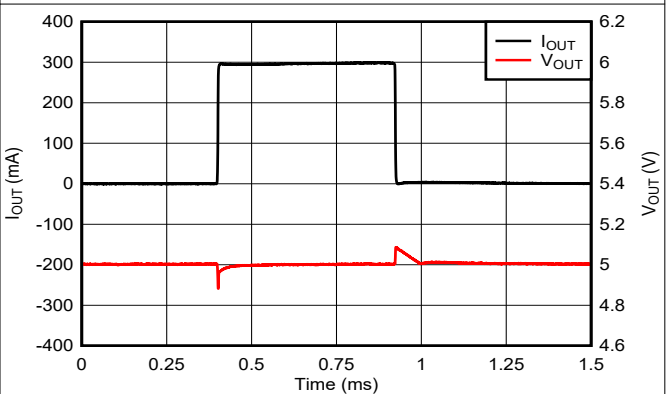

$V_{IN} = 8.8\text{V}$ ,  $V_{OUT} = 5.0\text{V}$ ,  $dI_{OUT}/dt = 0.1\text{A}/\mu\text{s}$

Figure 7-16. Load Transient (1mA to 300mA)

### 7.2.3 Application Curves (continued)

at operating temperature  $T_J = 25^\circ\text{C}$ ,  $V_{IN} = V_{OUT(NOM)} + 0.5\text{V}$  or  $2.5\text{V}$  (whichever is greater),  $I_{OUT} = 1\text{mA}$ ,  $C_{IN} = 1\mu\text{F}$ , and  $C_{OUT} = 1\mu\text{F}$  (unless otherwise noted)

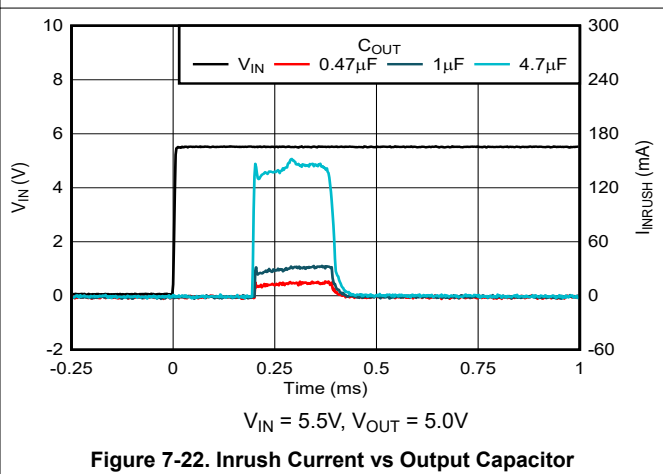
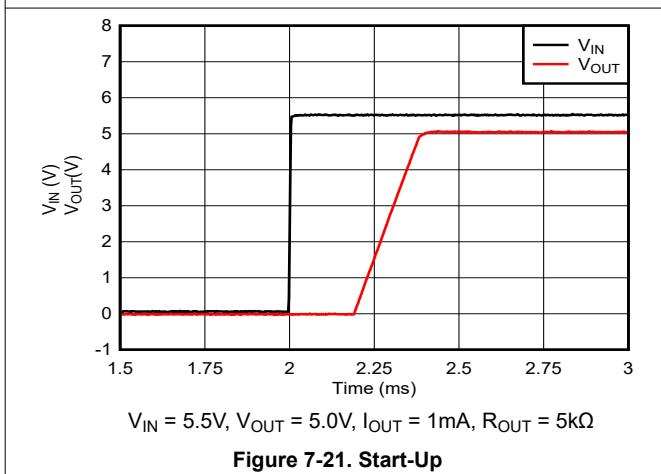
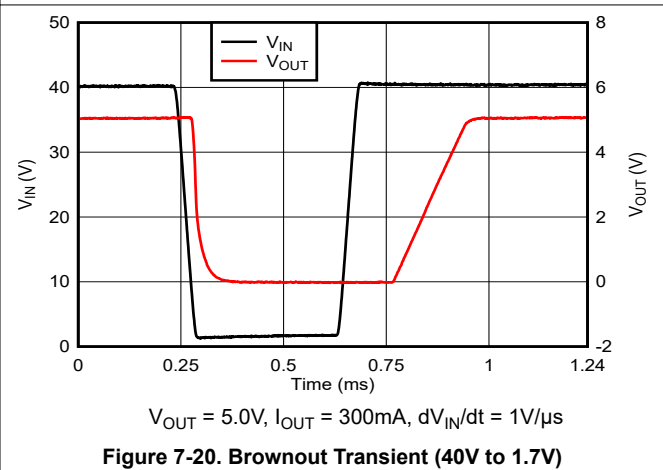
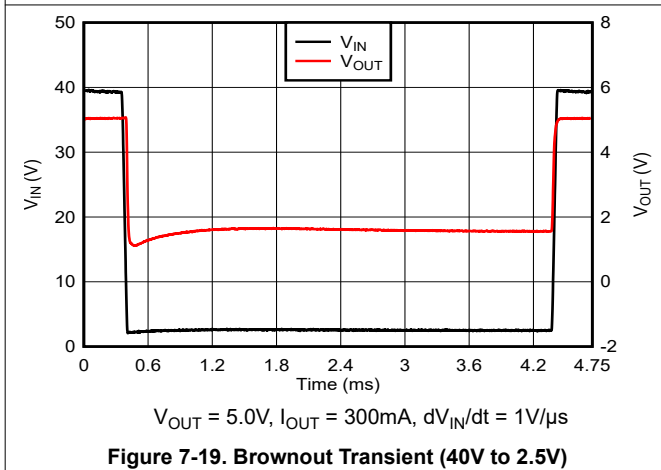
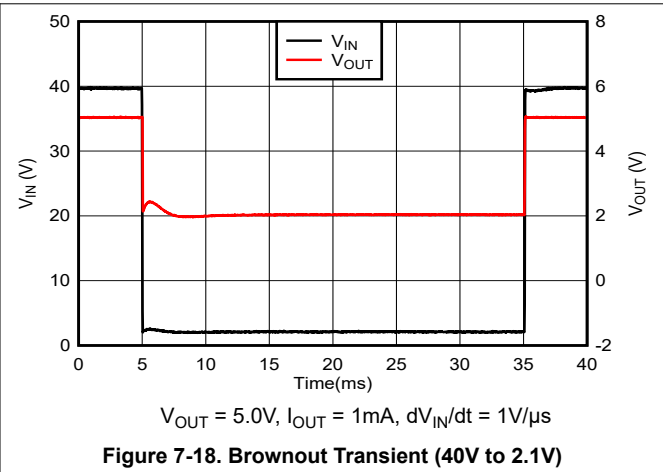
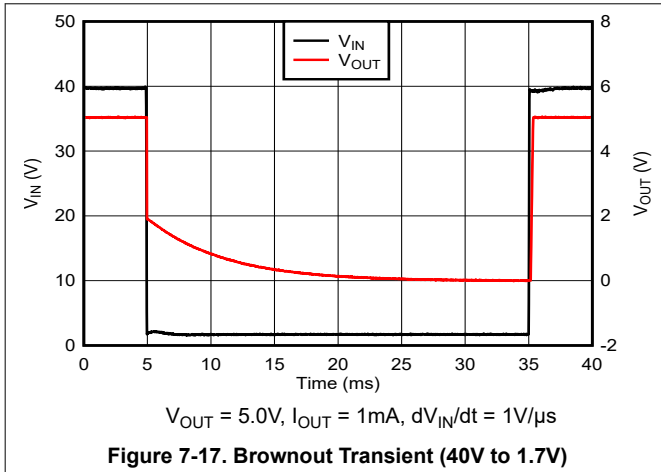

## 7.3 Best Design Practices

Place at least one 1.0µF capacitor as close as possible to the OUT and GND pins of the regulator.

Do not connect the output capacitor to the regulator using a long, thin trace.

Connect an input capacitor as close as possible to the IN and GND pins of the regulator for best performance.

Do not exceed the absolute maximum ratings.

## 7.4 Power Supply Recommendations

The TPS7B92 is designed to operate from an input voltage supply range between 2.5V and 40V. The input voltage range provides adequate headroom for the device to have a regulated output. If the input supply is noisy, additional input capacitors with low ESR help improve output noise performance.

## 7.5 Layout

### 7.5.1 Layout Guidelines

For best overall performance, follow the guidelines in this section. Place all circuit components on the same side of the printed circuit board (PCB) and as near as practical to the respective LDO pin connections. Place ground return connections for the input and output capacitors as close to the GND pin as possible, using wide, component-side, copper planes. Do not use vias and long traces to create LDO circuit connections to the input capacitor, output capacitor, or resistor divider. This practice negatively affects system performance. This grounding and layout scheme minimizes inductive parasitics, and thereby reduces load current transients, minimizes noise, and increases circuit stability. A ground reference plane is also recommended and is embedded in the PCB or located on the bottom side of the PCB opposite the components. This reference plane serves to provide accuracy of the output voltage and shield the LDO from noise.

#### 7.5.1.1 Power Dissipation

To provide reliable operation, make sure worst-case junction temperature does not exceed 125°C. This restriction limits the power dissipation the regulator handles in any given application. To make sure the junction temperature is within acceptable limits, calculate the maximum allowable dissipation ( $P_{D(max)}$ ). Also calculate the actual dissipation ( $P_D$ ) to be less than or equal to  $P_{D(max)}$ .

Equation 11 determines the maximum-power-dissipation limit:

$$P_{D(max)} = \frac{T_{Jmax} - T_A}{R_{\theta JA}} \quad (11)$$

where:

- $T_{Jmax}$  is the maximum allowable junction temperature
- $R_{\theta JA}$  is the thermal resistance junction-to-ambient for the package (see the *Thermal Information* table)
- $T_A$  is the ambient temperature

Equation 12 calculates the regulator dissipation:

$$P_D = (V_{IN} - V_{OUT}) \times I_{OUT} \quad (12)$$

### 7.5.2 Layout Example

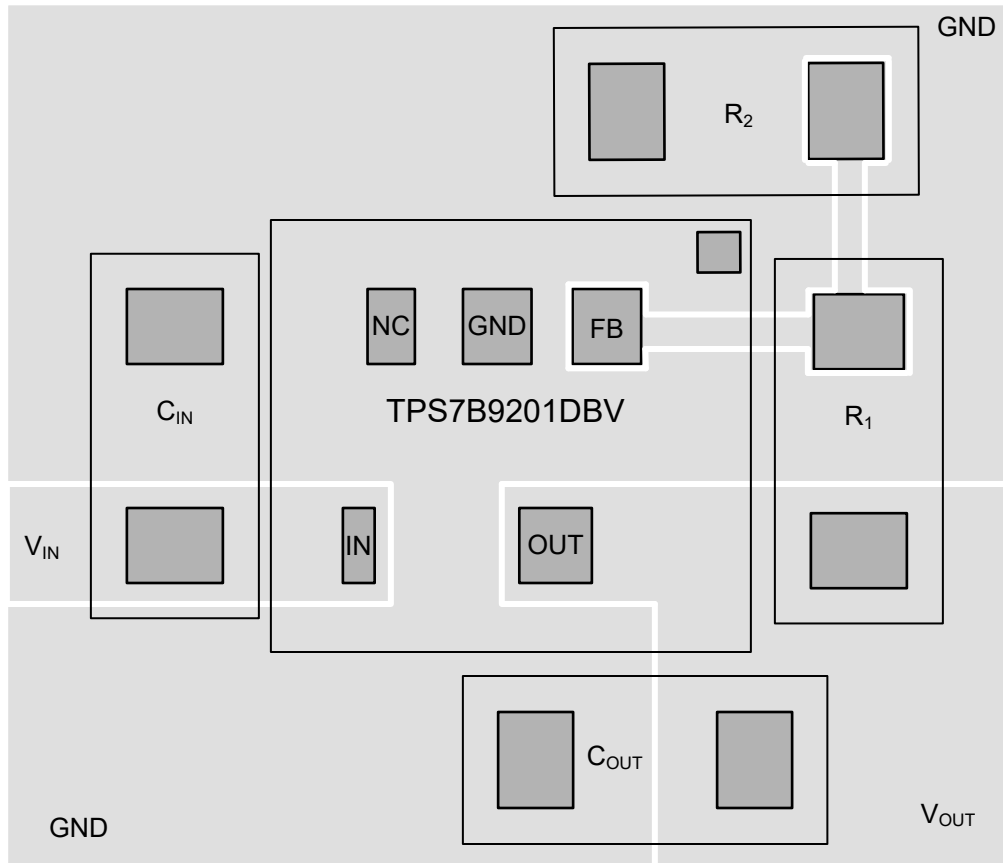

Figure 7-23. Example Layout for the TPS7B9201

## 8 Device and Documentation Support

### 8.1 Device Support

#### 8.1.1 Development Support

##### 8.1.1.1 Evaluation Module

An evaluation module (EVM) is available to assist in the initial circuit performance evaluation using the TPS7B92. The [Universal EVM](#) (and related [user's guide](#)) can be requested at the TI website through the product folders or purchased directly from [the TI eStore](#).

##### 8.1.1.2 Spice Models

Computer simulation of circuit performance using SPICE is often useful when analyzing the performance of analog circuits and systems. A SPICE model for the TPS7B92 is available through the product folders under *Tools & Software*.

#### 8.1.2 Device Nomenclature

**Table 8-1. Device Nomenclature**

PRODUCT <sup>(1)</sup>	V <sub>OUT</sub>
TPS7B92 xxDBVz	In the SOT-23 (DBV) package: <b>XX</b> is the nominal output voltage (for example, 33 = 3.3V, 50 = 5.0V, 01 = Adjustable). <b>Z</b> is the package quantity.

(1) For the most current package and ordering information see the Package Option Addendum at the end of this document, or see the TI website at [www.ti.com](#).

### 8.2 Documentation Support

#### 8.2.1 Related Documentation

For related documentation see the following:

- Texas Instruments, [Universal Low-Dropout Linear Voltage Regulator \(LDO\) Evaluation Module user guide](#)

### 8.3 Receiving Notification of Documentation Updates

To receive notification of documentation updates, navigate to the device product folder on [ti.com](#). Click on *Notifications* to register and receive a weekly digest of any product information that has changed. For change details, review the revision history included in any revised document.

### 8.4 Support Resources

[TI E2E™ support forums](#) are an engineer's go-to source for fast, verified answers and design help — straight from the experts. Search existing answers or ask your own question to get the quick design help you need.

Linked content is provided "AS IS" by the respective contributors. They do not constitute TI specifications and do not necessarily reflect TI's views; see TI's [Terms of Use](#).

### 8.5 Trademarks

TI E2E™ is a trademark of Texas Instruments.

All trademarks are the property of their respective owners.

### 8.6 Electrostatic Discharge Caution



This integrated circuit can be damaged by ESD. Texas Instruments recommends that all integrated circuits be handled with appropriate precautions. Failure to observe proper handling and installation procedures can cause damage.

ESD damage can range from subtle performance degradation to complete device failure. Precision integrated circuits may be more susceptible to damage because very small parametric changes could cause the device not to meet its published specifications.

### 8.7 Glossary

[TI Glossary](#) This glossary lists and explains terms, acronyms, and definitions.

## 9 Revision History

NOTE: Page numbers for previous revisions may differ from page numbers in the current version.

DATE	REVISION	NOTES
April 2024	*	Initial Release

## 10 Mechanical, Packaging, and Orderable Information

The following pages include mechanical, packaging, and orderable information. This information is the most current data available for the designated devices. This data is subject to change without notice and revision of this document. For browser-based versions of this data sheet, refer to the left-hand navigation.

**PACKAGING INFORMATION**

Orderable Device	Status (1)	Package Type	Package Drawing	Pins	Package Qty	Eco Plan (2)	Lead finish/ Ball material (6)	MSL Peak Temp (3)	Op Temp (°C)	Device Marking (4/5)	Samples
TPS7B92018DBVR	ACTIVE	SOT-23	DBV	5	3000	RoHS & Green	SN	Level-1-260C-UNLIM	-40 to 125	37EH	Samples
TPS7B92033DBVR	ACTIVE	SOT-23	DBV	5	3000	RoHS & Green	SN	Level-1-260C-UNLIM	-40 to 125	37FH	Samples
TPS7B92050DBVR	ACTIVE	SOT-23	DBV	5	3000	RoHS & Green	SN	Level-1-260C-UNLIM	-40 to 125	37GH	Samples
TPS7B92120DBVR	ACTIVE	SOT-23	DBV	5	3000	RoHS & Green	SN	Level-1-260C-UNLIM	-40 to 125	37HH	Samples

(1) The marketing status values are defined as follows:

**ACTIVE:** Product device recommended for new designs.

**LIFEBUY:** TI has announced that the device will be discontinued, and a lifetime-buy period is in effect.

**NRND:** Not recommended for new designs. Device is in production to support existing customers, but TI does not recommend using this part in a new design.

**PREVIEW:** Device has been announced but is not in production. Samples may or may not be available.

**OBSELETE:** TI has discontinued the production of the device.

(2) **RoHS:** TI defines "RoHS" to mean semiconductor products that are compliant with the current EU RoHS requirements for all 10 RoHS substances, including the requirement that RoHS substance do not exceed 0.1% by weight in homogeneous materials. Where designed to be soldered at high temperatures, "RoHS" products are suitable for use in specified lead-free processes. TI may reference these types of products as "Pb-Free".

**RoHS Exempt:** TI defines "RoHS Exempt" to mean products that contain lead but are compliant with EU RoHS pursuant to a specific EU RoHS exemption.

**Green:** TI defines "Green" to mean the content of Chlorine (Cl) and Bromine (Br) based flame retardants meet JS709B low halogen requirements of <=1000ppm threshold. Antimony trioxide based flame retardants must also meet the <=1000ppm threshold requirement.

(3) MSL, Peak Temp. - The Moisture Sensitivity Level rating according to the JEDEC industry standard classifications, and peak solder temperature.

(4) There may be additional marking, which relates to the logo, the lot trace code information, or the environmental category on the device.

(5) Multiple Device Markings will be inside parentheses. Only one Device Marking contained in parentheses and separated by a "-" will appear on a device. If a line is indented then it is a continuation of the previous line and the two combined represent the entire Device Marking for that device.

(6) Lead finish/Ball material - Orderable Devices may have multiple material finish options. Finish options are separated by a vertical ruled line. Lead finish/Ball material values may wrap to two lines if the finish value exceeds the maximum column width.

**Important Information and Disclaimer:**The information provided on this page represents TI's knowledge and belief as of the date that it is provided. TI bases its knowledge and belief on information provided by third parties, and makes no representation or warranty as to the accuracy of such information. Efforts are underway to better integrate information from third parties. TI has taken and

continues to take reasonable steps to provide representative and accurate information but may not have conducted destructive testing or chemical analysis on incoming materials and chemicals. TI and TI suppliers consider certain information to be proprietary, and thus CAS numbers and other limited information may not be available for release.

In no event shall TI's liability arising out of such information exceed the total purchase price of the TI part(s) at issue in this document sold by TI to Customer on an annual basis.



**TAPE AND REEL INFORMATION**

**QUADRANT ASSIGNMENTS FOR PIN 1 ORIENTATION IN TAPE**

\*All dimensions are nominal

Device	Package Type	Package Drawing	Pins	SPQ	Reel Diameter (mm)	Reel Width W1 (mm)	A0 (mm)	B0 (mm)	K0 (mm)	P1 (mm)	W (mm)	Pin1 Quadrant
TPS7B92018DBVR	SOT-23	DBV	5	3000	180.0	8.4	3.2	3.2	1.4	4.0	8.0	Q3
TPS7B92033DBVR	SOT-23	DBV	5	3000	180.0	8.4	3.2	3.2	1.4	4.0	8.0	Q3
TPS7B92050DBVR	SOT-23	DBV	5	3000	180.0	8.4	3.2	3.2	1.4	4.0	8.0	Q3
TPS7B92120DBVR	SOT-23	DBV	5	3000	180.0	8.4	3.2	3.2	1.4	4.0	8.0	Q3

## TAPE AND REEL BOX DIMENSIONS



\*All dimensions are nominal

Device	Package Type	Package Drawing	Pins	SPQ	Length (mm)	Width (mm)	Height (mm)
TPS7B92018DBVR	SOT-23	DBV	5	3000	210.0	185.0	35.0
TPS7B92033DBVR	SOT-23	DBV	5	3000	210.0	185.0	35.0
TPS7B92050DBVR	SOT-23	DBV	5	3000	210.0	185.0	35.0
TPS7B92120DBVR	SOT-23	DBV	5	3000	210.0	185.0	35.0



# EXAMPLE BOARD LAYOUT

DBV0005A

SOT-23 - 1.45 mm max height

SMALL OUTLINE TRANSISTOR



LAND PATTERN EXAMPLE  
EXPOSED METAL SHOWN  
SCALE:15X



SOLDER MASK DETAILS

4214839/K 08/2024

NOTES: (continued)

- 6. Publication IPC-7351 may have alternate designs.
- 7. Solder mask tolerances between and around signal pads can vary based on board fabrication site.

# EXAMPLE STENCIL DESIGN

DBV0005A

SOT-23 - 1.45 mm max height

SMALL OUTLINE TRANSISTOR



SOLDER PASTE EXAMPLE  
BASED ON 0.125 mm THICK STENCIL  
SCALE:15X

4214839/K 08/2024

NOTES: (continued)

8. Laser cutting apertures with trapezoidal walls and rounded corners may offer better paste release. IPC-7525 may have alternate design recommendations.
9. Board assembly site may have different recommendations for stencil design.

## IMPORTANT NOTICE AND DISCLAIMER

TI PROVIDES TECHNICAL AND RELIABILITY DATA (INCLUDING DATA SHEETS), DESIGN RESOURCES (INCLUDING REFERENCE DESIGNS), APPLICATION OR OTHER DESIGN ADVICE, WEB TOOLS, SAFETY INFORMATION, AND OTHER RESOURCES "AS IS" AND WITH ALL FAULTS, AND DISCLAIMS ALL WARRANTIES, EXPRESS AND IMPLIED, INCLUDING WITHOUT LIMITATION ANY IMPLIED WARRANTIES OF MERCHANTABILITY, FITNESS FOR A PARTICULAR PURPOSE OR NON-INFRINGEMENT OF THIRD PARTY INTELLECTUAL PROPERTY RIGHTS.

These resources are intended for skilled developers designing with TI products. You are solely responsible for (1) selecting the appropriate TI products for your application, (2) designing, validating and testing your application, and (3) ensuring your application meets applicable standards, and any other safety, security, regulatory or other requirements.

These resources are subject to change without notice. TI grants you permission to use these resources only for development of an application that uses the TI products described in the resource. Other reproduction and display of these resources is prohibited. No license is granted to any other TI intellectual property right or to any third party intellectual property right. TI disclaims responsibility for, and you will fully indemnify TI and its representatives against, any claims, damages, costs, losses, and liabilities arising out of your use of these resources.

TI's products are provided subject to [TI's Terms of Sale](#) or other applicable terms available either on [ti.com](https://www.ti.com) or provided in conjunction with such TI products. TI's provision of these resources does not expand or otherwise alter TI's applicable warranties or warranty disclaimers for TI products.

TI objects to and rejects any additional or different terms you may have proposed.

Mailing Address: Texas Instruments, Post Office Box 655303, Dallas, Texas 75265  
Copyright © 2024, Texas Instruments Incorporated