

**ABSTRACT**

This user's guide describes the characteristics, operation, and use of the INA241x evaluation module (EVM). This EVM is designed to evaluate the performance of the INA241A or INA241B voltage-output, current shunt monitor in a variety of configurations. Throughout this document, the terms evaluation board, evaluation module, and EVM are synonymous with the INA241EVM. This document also includes a schematic, reference printed circuit board (PCB) layouts, and a complete bill of materials (BOM).

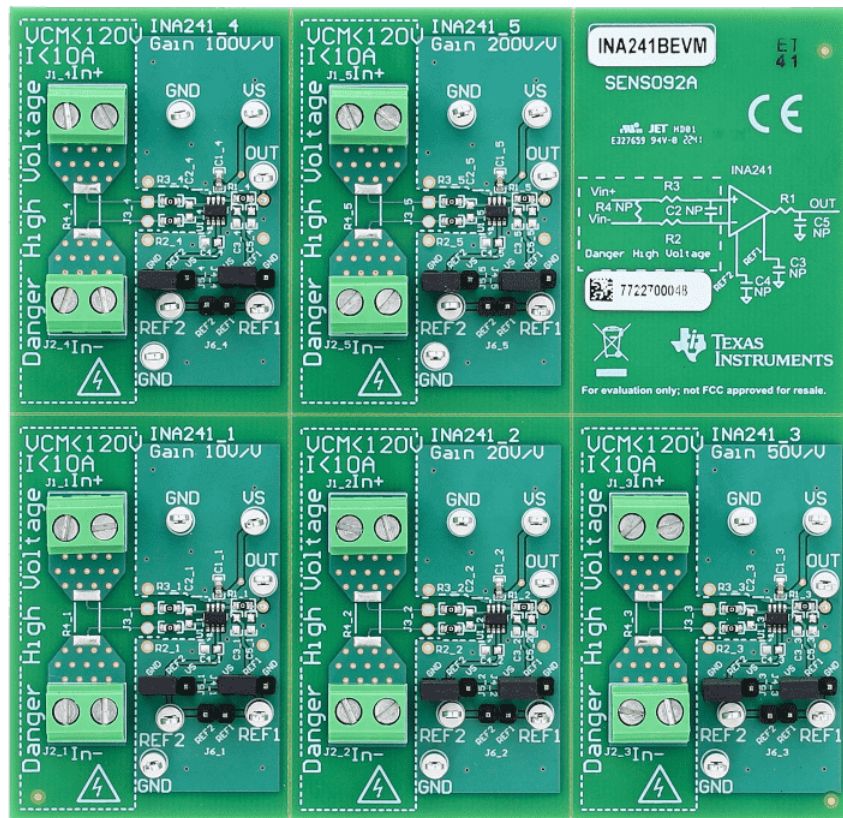

## Table of Contents

<b>1 General Texas Instruments High Voltage Evaluation (TI HV EVM) User Safety Guidelines</b> .....	<b>3</b>
<b>2 Overview</b> .....	<b>4</b>
2.1 EVM Kit Contents.....	4
2.2 Related Documentation From Texas Instruments.....	4
<b>3 Hardware</b> .....	<b>5</b>
3.1 Features.....	5
<b>4 Operation</b> .....	<b>6</b>
4.1 Quick Start Setup.....	6
4.2 Measurements.....	6
<b>5 EVM Components</b> .....	<b>7</b>
5.1 R1_n, R2_n, R3_n, C2_n, C5_n.....	7
5.2 C1_n.....	7
5.3 R4_n.....	7
5.4 U1_n (INA241x).....	7
<b>6 Schematic, PCB Layout, and Bill of Materials</b> .....	<b>8</b>
6.1 Schematic.....	8
6.2 PCB Layout.....	9
6.3 Bill of Materials.....	11
<b>7 Revision History</b> .....	<b>13</b>

## List of Figures

Figure 6-1. INA241EVM Schematic: Gain Option 1 Panel.....	8
Figure 6-2. INA241EVM Top Overlay.....	9
Figure 6-3. INA241EVM Bottom Overlay.....	9
Figure 6-4. INA241EVM Top Layer.....	9
Figure 6-5. INA241EVM Bottom Layer.....	9
Figure 6-6. INA241EVM Top Solder.....	10
Figure 6-7. INA241EVM Bottom Solder.....	10
Figure 6-8. INA241EVM Drill Drawing.....	10

## List of Tables

Table 2-1. INA241x Gain Option Summary.....	4
Table 2-2. INA241EVM Kit Contents.....	4
Table 2-3. Related Documentation.....	4
Table 6-1. Bill of Materials.....	11

## Trademarks

All trademarks are the property of their respective owners.

# 1 General Texas Instruments High Voltage Evaluation (TI HV EVM) User Safety Guidelines



Always follow TI's setup and application instructions, including use of all interface components within their recommended electrical rated voltage and power limits. Always use electrical safety precautions to help ensure your personal safety and those working around you. Contact TI's Product Information Center <http://support/ti.com> for further information.

**Save all warnings and instructions for future reference.**

**WARNING**

Failure to follow warnings and instructions may result in personal injury, property damage or death due to electrical shock and burn hazards.

The term TI HV EVM refers to an electronic device typically provided as an open framed, unenclosed printed circuit board assembly. It is *intended strictly for use in development laboratory environments, solely for qualified professional users having training, expertise and knowledge of electrical safety risks in development and application of high voltage electrical circuits. Any other use and/or application are strictly prohibited by Texas Instruments.* If you are not suitable qualified, you should immediately stop from further use of the HV EVM.

## 1. Work Area Safety

- a. Keep work area clean and orderly.
- b. Qualified observer(s) must be present anytime circuits are energized.
- c. Effective barriers and signage must be present in the area where the TI HV EVM and its interface electronics are energized, indicating operation of accessible high voltages may be present, for the purpose of protecting inadvertent access.
- d. All interface circuits, power supplies, evaluation modules, instruments, meters, scopes and other related apparatus used in a development environment exceeding 50Vrms/75VDC must be electrically located within a protected Emergency Power Off EPO protected power strip.
- e. Use stable and nonconductive work surface.
- f. Use adequately insulated clamps and wires to attach measurement probes and instruments. No freehand testing whenever possible.

## 2. Electrical Safety

As a precautionary measure, it is always a good engineering practice to assume that the entire EVM may have fully accessible and active high voltages.

- a. De-energize the TI HV EVM and all its inputs, outputs and electrical loads before performing any electrical or other diagnostic measurements. Revalidate that TI HV EVM power has been safely de-energized.
- b. With the EVM confirmed de-energized, proceed with required electrical circuit configurations, wiring, measurement equipment connection, and other application needs, while still assuming the EVM circuit and measuring instruments are electrically live.
- c. After EVM readiness is complete, energize the EVM as intended.

**WARNING**

While the EVM is energized, never touch the EVM or its electrical circuits, as they could be at high voltages capable of causing electrical shock hazard.

## 3. Personal Safety

- a. Wear personal protective equipment (for example, latex gloves or safety glasses with side shields) or protect EVM in an adequate lucent plastic box with interlocks to protect from accidental touch.

### Limitation for safe use:

EVMs are not to be used as all or part of a production unit.

## 2 Overview

The INA241x device is a voltage-output, high-side current sense amplifier in a small SOT-23 (8) package with enhanced common-mode PWM rejection and bandwidth of 1 Mhz for all gain options. As shown in [Table 2-1](#), the INA241x has gains that range from 10 V/V to 200 V/V, depending on the gain option that is selected. The only difference between the INA241AEVM and INA241BEVM options is which software version is installed on the device: "A" or "B". The voltage developed across the device inputs is amplified by the corresponding gain of the specific device, and is presented at the output pin. The device can accurately sense voltage drops across shunts at  $-4\text{V}$  to  $+110\text{V}$  common-mode voltages. The device survives common-mode voltages from  $-20\text{V}$  to  $+120\text{V}$ . The device operates with supply voltages between  $2.7\text{V}$  and  $20\text{V}$ , and draws a typical of  $2.5\text{mA}$  at room temperature.

**Table 2-1. INA241x Gain Option Summary**

Product	Gain (V/V)
INA241A1, INA241B1	10
INA241A2, INA241B2	20
INA241A3, INA241B3	50
INA241A4, INA241B4	100
INA241A5, INA241B5	200

### 2.1 EVM Kit Contents

[Table 2-2](#) summarizes the contents of the INA241EVM kit. Contact the nearest [Texas Instruments Product Information Center](#) if any component is missing. TI also recommends to check the device product folders at [www.ti.com](#) for any further information regarding this product.

**Table 2-2. INA241EVM Kit Contents**

Item	Item Part Number	Quantity
INA241EVM test board	<a href="#">INA241AEVM</a> or <a href="#">INA241BEVM</a>	1

### 2.2 Related Documentation From Texas Instruments

This document provides information regarding Texas Instruments' integrated circuits used in the assembly of the INA241EVM.

**Table 2-3. Related Documentation**

Document	Literature Number
<a href="#">INA241A</a> and <a href="#">INA241B</a> product data sheet	<a href="#">SBOSA30</a>

## 3 Hardware

The INA241EVM provides a basic functional evaluation of the INA241x. The fixture layout is not intended to be a model for the target circuit, nor is it laid out for electromagnetic compatibility (EMC) testing. The INA241EVM is one PCB with five optional PCB cutouts the engineer can use to test each of the five gain options (1 to 5) listed in [Table 2-1](#). Each PCB cutout has one INA241xn device (where  $n$  is 1, 2, 3, 4, or 5), test points and sockets for external hardware connections, and pads to solder down optional circuitry.

### 3.1 Features

The INA241EVM PCB provides the following features:

- Evaluation of all gain options through provided device boards
- Ease of access to device pins with test points
- Pads and sockets for optional filtering at the input pins and output pin
- Multiple input signal options, including a method to solder a shunt resistor (2512) and safely measure current up to 10 A.

See the device data sheet for comprehensive information about the INA241EVM and the available gain options.

## 4 Operation

### 4.1 Quick Start Setup

Follow these procedures to set up and use one of the INA241EVM panels. For these instructions, n is gain option 1, 2, 3, 4, or 5.

1. Choose the desired gain option panel variation.
2. Connect an external DC supply voltage (between 2.7 V and 20 V) to a VS test point. Connect the ground reference of that supply to a GND test point on the same panel.
3. Provide a differential input voltage signal to the Vin+ and Vin– nodes by connecting the signal leads to the J1\_n and J2\_n on the EVM, as explained in [Section 4.2](#). The INA241x is a bidirectional current-sensing device that has a reference pin. With this reference pin, the device can measure current in both directions. To use 1/2 of the supply voltage (VS) as the reference, place shorting bars on jumper J4, connect REF1 to VS and J5, and connect REF2 to GND. If you only want to measure unidirectional current, be careful not to short VS to GND. Remove the jumpers from J4 and J5 before placing a jumper on J6. After J6 shorts Ref1 to Ref2, place one jumper on J4 or J5 or drive the Ref1 and Ref2 pins to create your own reference voltage.

### 4.2 Measurements

The user can either emulate the voltage developed across a sense resistor based on a given set of system conditions with the INA241EVM, or connect the device inputs to an external shunt. The user can also solder a surface-mount technology (SMT) shunt resistor across the In+ and In– pads, and these inputs can be connected in series with the external system and load.

To configure a measurement evaluation without a shunt resistor, follow this procedure:

1. Connect a differential voltage across the In+ (J1\_n) and In– (J2\_n) tabs.
2. Connect a 2.7-V to 110-V common-mode voltage to the inputs if the differential voltage supply is a floating supply. Connect the positive lead of the external voltage source to the In– (J1\_n) tab and source ground to a GND test point. The minimum common-mode voltage should be  $> -4V$ . This action effectively raises the absolute common-mode voltage of the input pins.
3. Measure the output voltage at the Vout test point with respect to GND.

To configure a measurement evaluation with a shunt resistor, follow this procedure:

1. Solder a 2512 resistor at the R1\_n pads that connects the In+ (J1\_n) and In– (J1\_n) inputs.
2. Connect the In+ (J1\_n) and In– (J2\_n) tabs in series with the load and bus voltage sources while powered off.

#### WARNING

Make sure that the equipment (shunt resistor, wires, connectors, and so on) can support the amperage and power dissipation first before you measure the current. Also make sure that the current flowing through J1 does not exceed 10 A. Failure to do so can result in hot surfaces ( $> 55^{\circ}C$ ), damage to the EVM, or personal injury.

3. Power on the system and measure the output voltage at the Vout test point. Vout is equal to the gain of the device multiplied by the differential voltage measured directly at the device input pins. If bidirectional, use voltage is referenced to VS/2. If unidirectional, the output is referenced to voltage applied at Ref1 and Ref2.

## 5 EVM Components

This section summarizes the INA241EVM components. For these instructions, n is gain option 1, 2, 3, 4, or 5.

### 5.1 R1\_n, R2\_n, R3\_n, C2\_n, C5\_n

R1\_n, R2\_n, and R3\_n are factory-installed 0- $\Omega$  0603 resistors.

C2\_n and C5\_n, are not populated.

Collectively, these pads allow user-defined filters for the input pins (IN+ and IN-) and the output pin (OUT) of the INA241x. If a filter is desired, remove these resistors and replace them with > 0- $\Omega$  SMT resistors and populate the capacitor pads with capacitors. Consider the input bias current of the device when using input filtering.

### 5.2 C1\_n

C1\_n is a 0.1- $\mu$ F, power-supply bypass capacitor.

### 5.3 R4\_n

R4\_n is unpopulated, but allows the user to solder down a surface-mount shunt resistor between the In+ and In- pads sensed by IN+ and IN- input pins. If used, make sure R4\_n has proper power dissipation for the selected current load. The chosen resistor must have a 2512 footprint.

### 5.4 U1\_n (INA241x)

U1\_n is the location for the INA241xn test device.

Consider these factors when selecting the appropriate device gain:

- The differential input voltage is either applied across the inputs or developed based on the load current that flows through the shunt resistor.
- Make sure that the output voltage does not exceed the supply voltage. This limiting factor requires attention to device selection.
- The selected device must allow the output voltage to remain within the acceptable range after the developed input voltage is amplified by the respective device gain. The output voltage must remain within the device-specified swing limitations for response in the linear range.
- An output below the minimum allowable output requires a device with a higher gain. Likewise, an output above the maximum allowable output requires a device with a lower gain.

## 6 Schematic, PCB Layout, and Bill of Materials

### Note

Board layouts are not to scale. These figures are intended to show how the board is laid out. They are not intended to be used for INA241EVM PCB manufacturing.

### 6.1 Schematic

Figure 6-1 shows the schematic for one of the gain panels on the INA241EVM PCB. All other panels will have reference designators as subscript "\_x" where "x" is the gain option.

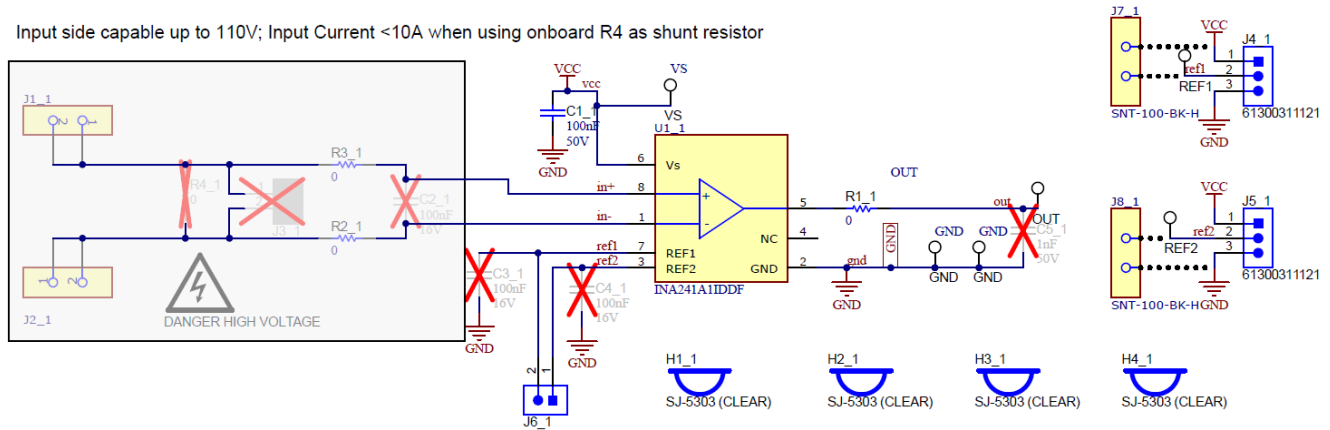

Figure 6-1. INA241EVM Schematic: Gain Option 1 Panel



## 6.2 PCB Layout

Figure 6-2 through Figure 6-8 show the PCB layout for the INA241EVM.

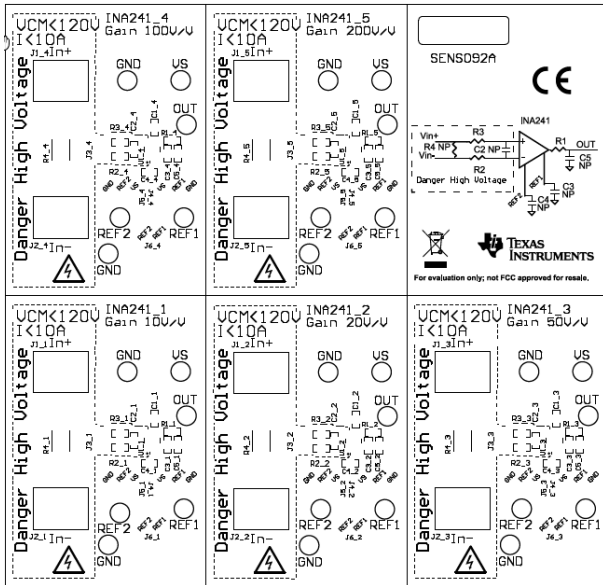

Figure 6-2. INA241EVM Top Overlay

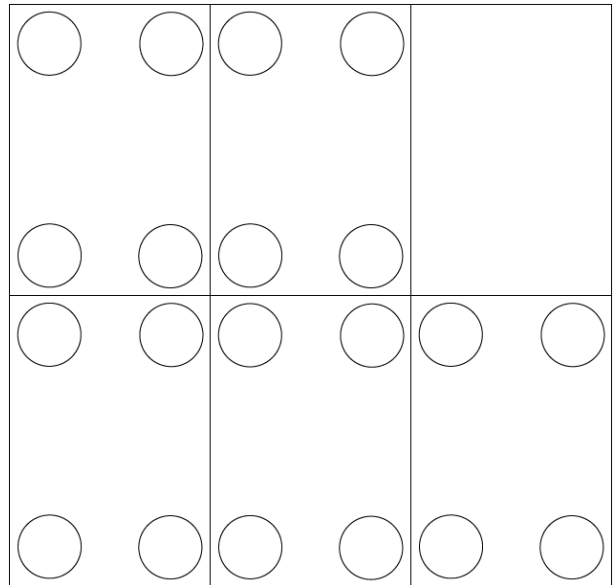

Figure 6-3. INA241EVM Bottom Overlay

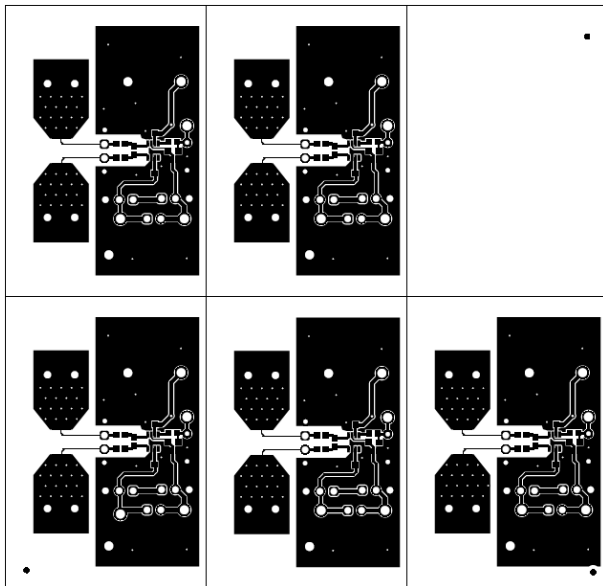

Figure 6-4. INA241EVM Top Layer

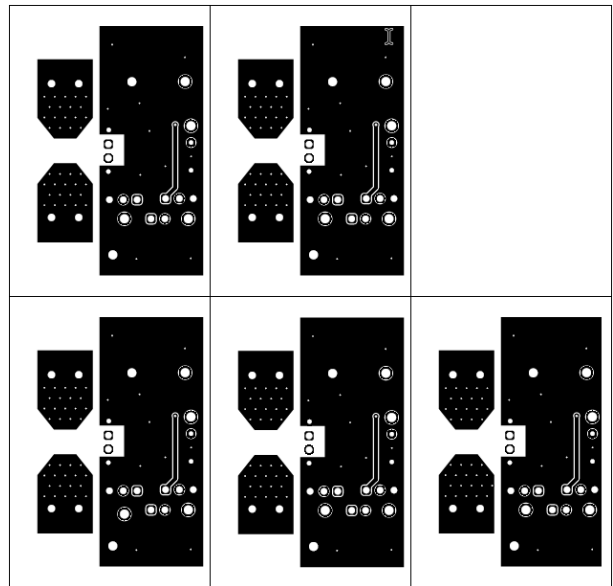

Figure 6-5. INA241EVM Bottom Layer

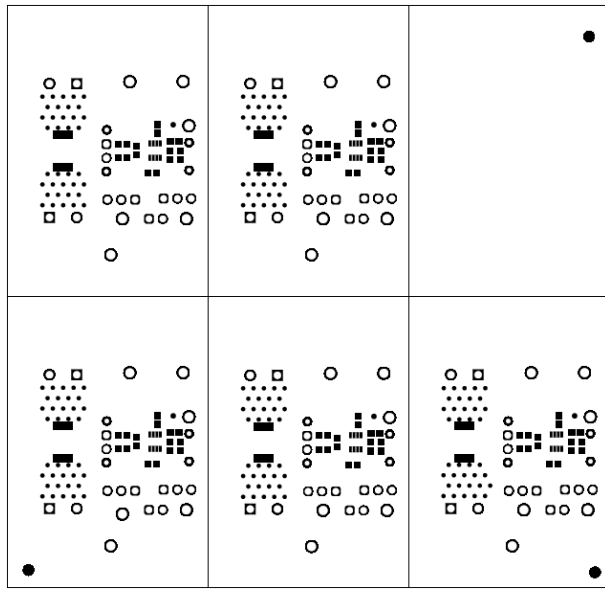

Figure 6-6. INA241EVM Top Solder

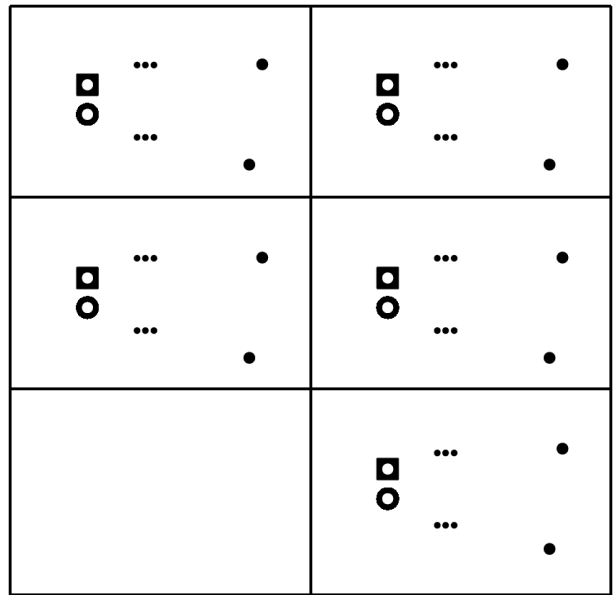

Figure 6-7. INA241EVM Bottom Solder

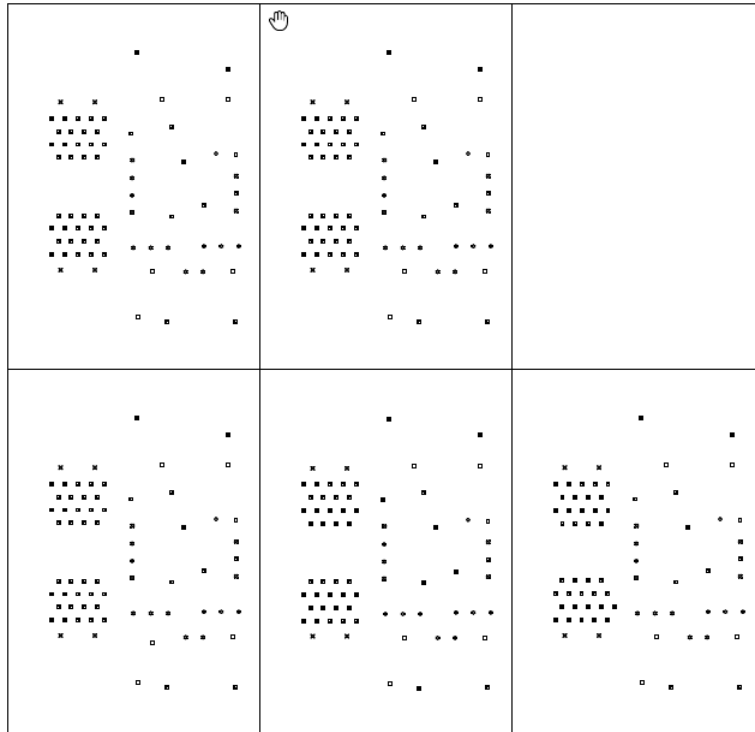

Figure 6-8. INA241EVM Drill Drawing

Symbol	Quantity	Finished Hole Size	Plated	Hole Type	Drill Layer Pair	Hole Tolerance
□	231	10.00mil (0.254mm)	PTH	Round	Top Layer - Bottom Layer	
◇	5	16.00mil (0.406mm)	PTH	Round	Top Layer - Bottom Layer	
⊗	20	30.00mil (0.762mm)	PTH	Round	Top Layer - Bottom Layer	
⊛	50	45.28mil (1.150mm)	PTH	Round	Top Layer - Bottom Layer	
⊘	20	51.18mil (1.300mm)	PTH	Round	Top Layer - Bottom Layer	
□	30	63.00mil (1.600mm)	PTH	Round	Top Layer - Bottom Layer	
	358 Total					

### 6.3 Bill of Materials

Table 6-1 provides the parts list for the INA241EVM.

**Table 6-1. Bill of Materials**

Designator	QTY	Value	Description	Package Reference	Part Number	Manufacturer
C1_1, C1_2, C1_3, C1_4, C1_5	5	0.1uF	CAP, CERM, 0.1 uF, 50 V,+/- 10%, X7R, AEC-Q200 Grade 1, 0603	603	C0603C104K5RACAUTO	Kemet
FID1, FID2, FID3	3		Fiducial mark. There is nothing to buy or mount.	N/A	N/A	N/A
H1_1, H1_2, H1_3, H1_4, H1_5, H2_1, H2_2, H2_3, H2_4, H2_5, H3_1, H3_2, H3_3, H3_4, H3_5, H4_1, H4_2, H4_3, H4_4, H4_5	20		Bumpon, Hemisphere, 0.44 X 0.20, Clear	Transparent Bumpon	SJ-5303 (CLEAR)	3M
J1_1, J1_2, J1_3, J1_4, J1_5, J2_1, J2_2, J2_3, J2_4, J2_5	10		TERM BLK 2POS SIDE ENTRY 5MM PCB	HDR2	6.91138E+11	Würth Elektronik
J4_1, J4_2, J4_3, J4_4, J4_5, J5_1, J5_2, J5_3, J5_4, J5_5	10		Header, 2.54 mm, 3x1, Gold, TH	Header, 2.54mm, 3x1, TH	61300311121	Würth Elektronik
J6_1, J6_2, J6_3, J6_4, J6_5	5		Header, 2.54 mm, 2x1, Gold, TH	Header, 2.54mm, 2x1, TH	61300211121	Würth Elektronik
J7_1, J7_2, J7_3, J7_4, J7_5, J8_1, J8_2, J8_3, J8_4, J8_5	10			CONN_JUMPER	SNT-100-BK-H	Samtec
LBL1	1		Thermal Transfer Printable Labels, 0.650" W x 0.200" H - 10,000 per roll	PCB Label 0.650 x 0.200 inch	THT-14-423-10	Brady
R1_1, R1_2, R1_3, R1_4, R1_5, R2_1, R2_2, R2_3, R2_4, R2_5, R3_1, R3_2, R3_3, R3_4, R3_5	15	0	RES, 0, 5%, 0.1 W, 0603	603	RC0603JR-070RL	Yageo
TP1_1, TP1_2, TP1_3, TP1_4, TP1_5, TP2_1, TP2_2, TP2_3, TP2_4, TP2_5, TP3_1, TP3_2, TP3_3, TP3_4, TP3_5, TP4_1, TP4_2, TP4_3, TP4_4, TP4_5, TP5_1, TP5_2, TP5_3, TP5_4, TP5_5, TP6_1, TP6_2, TP6_3, TP6_4, TP6_5	30		Test Point, Multipurpose, White, TH	White Multipurpose Testpoint	5012	Keystone Electronics
U1_1	1		-4-V to 110V, Bidirectional, Ultra-Precise Current Sense Amplifier With Enhanced PWM Rejection	SOT-23-8	INA241A1IDDF or INA241B1IDDF	Texas Instruments
U1_2	1		-4-V to 110V, Bidirectional, Ultra-Precise Current Sense Amplifier With Enhanced PWM Rejection	SOT-23-8	INA241A2IDDF or INA241B2IDDF	Texas Instruments

**Table 6-1. Bill of Materials (continued)**

Designator	QTY	Value	Description	Package Reference	Part Number	Manufacturer
U1_3	1		-4-V to 110-V, Bidirectional, Ultra-Precise Current Sense Amplifier With Enhanced PWM Rejection	SOT23-8	INA241A3IDDF or INA241B3IDDF	Texas Instruments
U1_4	1		-4-V to 110-V, Bidirectional, Ultra-Precise Current Sense Amplifier With Enhanced PWM Rejection	SOT-23-8	INA241A4IDDF or INA241B4IDDF	Texas Instruments
U1_5	1		-4-V to 110-V, Bidirectional, Ultra-Precise Current Sense Amplifier With Enhanced PWM Rejection	SOT-23-8	INA241A5IDDF or INA241B5IDDF	Texas Instruments
C2_1, C2_2, C2_3, C2_4, C2_5, C3_1, C3_2, C3_3, C3_4, C3_5, C4_1, C4_2, C4_3, C4_4, C4_5	0	0.1uF	CAP, CERM, 0.1 uF, 16 V, +/- 5%, X7R, 0603	603	0603YC104JAT2A	AVX
C5_1, C5_2, C5_3, C5_4, C5_5	0	1000pF	CAP, CERM, 1000 pF, 50 V, +/- 10%, X7R, 0603	603	C0603X102K5RACTU	Kemet
J3_1, J3_2, J3_3, J3_4, J3_5	0		Header, 2.54 mm, 2x1, Gold, TH	Header, 2.54mm, 2x1, TH	61300211121	Wurth Elektronik
R4_1, R4_2, R4_3, R4_4, R4_5	0	0	RES, 0, 0.05%, 2 W, AEC-Q200 Grade 0, 2512	2512	HCJ2512ZT0R00	Stackpole Electronics Inc

## 7 Revision History

NOTE: Page numbers for previous revisions may differ from page numbers in the current version.

<b>Changes from Revision * (March 2022) to Revision A (November 2022)</b>	<b>Page</b>
• Added INA241EVM device options: INA241AEVM and INA241BEVM.....	1
• Changed <a href="#">Table 2-1</a> .....	4
• Changed <a href="#">Table 2-2</a> .....	4
• Removed sentence 'Only gain options A1, A2, and A3 are populated' in <a href="#">Section 3</a> .....	5
• Changed <a href="#">Figure 6-2</a> .....	9
• Changed <a href="#">Table 6-1</a> .....	11

## STANDARD TERMS FOR EVALUATION MODULES

1. *Delivery:* TI delivers TI evaluation boards, kits, or modules, including any accompanying demonstration software, components, and/or documentation which may be provided together or separately (collectively, an "EVM" or "EVMs") to the User ("User") in accordance with the terms set forth herein. User's acceptance of the EVM is expressly subject to the following terms.
  - 1.1 EVMs are intended solely for product or software developers for use in a research and development setting to facilitate feasibility evaluation, experimentation, or scientific analysis of TI semiconductor products. EVMs have no direct function and are not finished products. EVMs shall not be directly or indirectly assembled as a part or subassembly in any finished product. For clarification, any software or software tools provided with the EVM ("Software") shall not be subject to the terms and conditions set forth herein but rather shall be subject to the applicable terms that accompany such Software
  - 1.2 EVMs are not intended for consumer or household use. EVMs may not be sold, sublicensed, leased, rented, loaned, assigned, or otherwise distributed for commercial purposes by Users, in whole or in part, or used in any finished product or production system.
2. *Limited Warranty and Related Remedies/Disclaimers:*
  - 2.1 These terms do not apply to Software. The warranty, if any, for Software is covered in the applicable Software License Agreement.
  - 2.2 TI warrants that the TI EVM will conform to TI's published specifications for ninety (90) days after the date TI delivers such EVM to User. Notwithstanding the foregoing, TI shall not be liable for a nonconforming EVM if (a) the nonconformity was caused by neglect, misuse or mistreatment by an entity other than TI, including improper installation or testing, or for any EVMs that have been altered or modified in any way by an entity other than TI, (b) the nonconformity resulted from User's design, specifications or instructions for such EVMs or improper system design, or (c) User has not paid on time. Testing and other quality control techniques are used to the extent TI deems necessary. TI does not test all parameters of each EVM. User's claims against TI under this Section 2 are void if User fails to notify TI of any apparent defects in the EVMs within ten (10) business days after delivery, or of any hidden defects with ten (10) business days after the defect has been detected.
  - 2.3 TI's sole liability shall be at its option to repair or replace EVMs that fail to conform to the warranty set forth above, or credit User's account for such EVM. TI's liability under this warranty shall be limited to EVMs that are returned during the warranty period to the address designated by TI and that are determined by TI not to conform to such warranty. If TI elects to repair or replace such EVM, TI shall have a reasonable time to repair such EVM or provide replacements. Repaired EVMs shall be warranted for the remainder of the original warranty period. Replaced EVMs shall be warranted for a new full ninety (90) day warranty period.

### **WARNING**

**Evaluation Kits are intended solely for use by technically qualified, professional electronics experts who are familiar with the dangers and application risks associated with handling electrical mechanical components, systems, and subsystems.**

**User shall operate the Evaluation Kit within TI's recommended guidelines and any applicable legal or environmental requirements as well as reasonable and customary safeguards. Failure to set up and/or operate the Evaluation Kit within TI's recommended guidelines may result in personal injury or death or property damage. Proper set up entails following TI's instructions for electrical ratings of interface circuits such as input, output and electrical loads.**

**NOTE:**

**EXPOSURE TO ELECTROSTATIC DISCHARGE (ESD) MAY CAUSE DEGRADATION OR FAILURE OF THE EVALUATION KIT; TI RECOMMENDS STORAGE OF THE EVALUATION KIT IN A PROTECTIVE ESD BAG.**

### 3 Regulatory Notices:

#### 3.1 United States

##### 3.1.1 Notice applicable to EVMs not FCC-Approved:

**FCC NOTICE:** This kit is designed to allow product developers to evaluate electronic components, circuitry, or software associated with the kit to determine whether to incorporate such items in a finished product and software developers to write software applications for use with the end product. This kit is not a finished product and when assembled may not be resold or otherwise marketed unless all required FCC equipment authorizations are first obtained. Operation is subject to the condition that this product not cause harmful interference to licensed radio stations and that this product accept harmful interference. Unless the assembled kit is designed to operate under part 15, part 18 or part 95 of this chapter, the operator of the kit must operate under the authority of an FCC license holder or must secure an experimental authorization under part 5 of this chapter.

##### 3.1.2 For EVMs annotated as FCC – FEDERAL COMMUNICATIONS COMMISSION Part 15 Compliant:

#### **CAUTION**

This device complies with part 15 of the FCC Rules. Operation is subject to the following two conditions: (1) This device may not cause harmful interference, and (2) this device must accept any interference received, including interference that may cause undesired operation.

Changes or modifications not expressly approved by the party responsible for compliance could void the user's authority to operate the equipment.

#### **FCC Interference Statement for Class A EVM devices**

*NOTE: This equipment has been tested and found to comply with the limits for a Class A digital device, pursuant to part 15 of the FCC Rules. These limits are designed to provide reasonable protection against harmful interference when the equipment is operated in a commercial environment. This equipment generates, uses, and can radiate radio frequency energy and, if not installed and used in accordance with the instruction manual, may cause harmful interference to radio communications. Operation of this equipment in a residential area is likely to cause harmful interference in which case the user will be required to correct the interference at his own expense.*

#### **FCC Interference Statement for Class B EVM devices**

*NOTE: This equipment has been tested and found to comply with the limits for a Class B digital device, pursuant to part 15 of the FCC Rules. These limits are designed to provide reasonable protection against harmful interference in a residential installation. This equipment generates, uses and can radiate radio frequency energy and, if not installed and used in accordance with the instructions, may cause harmful interference to radio communications. However, there is no guarantee that interference will not occur in a particular installation. If this equipment does cause harmful interference to radio or television reception, which can be determined by turning the equipment off and on, the user is encouraged to try to correct the interference by one or more of the following measures:*

- Reorient or relocate the receiving antenna.
- Increase the separation between the equipment and receiver.
- Connect the equipment into an outlet on a circuit different from that to which the receiver is connected.
- Consult the dealer or an experienced radio/TV technician for help.

#### 3.2 Canada

##### 3.2.1 For EVMs issued with an Industry Canada Certificate of Conformance to RSS-210 or RSS-247

#### **Concerning EVMs Including Radio Transmitters:**

This device complies with Industry Canada license-exempt RSSs. Operation is subject to the following two conditions:

(1) this device may not cause interference, and (2) this device must accept any interference, including interference that may cause undesired operation of the device.

#### **Concernant les EVMs avec appareils radio:**

Le présent appareil est conforme aux CNR d'Industrie Canada applicables aux appareils radio exempts de licence. L'exploitation est autorisée aux deux conditions suivantes: (1) l'appareil ne doit pas produire de brouillage, et (2) l'utilisateur de l'appareil doit accepter tout brouillage radioélectrique subi, même si le brouillage est susceptible d'en compromettre le fonctionnement.

#### **Concerning EVMs Including Detachable Antennas:**

Under Industry Canada regulations, this radio transmitter may only operate using an antenna of a type and maximum (or lesser) gain approved for the transmitter by Industry Canada. To reduce potential radio interference to other users, the antenna type and its gain should be so chosen that the equivalent isotropically radiated power (e.i.r.p.) is not more than that necessary for successful communication. This radio transmitter has been approved by Industry Canada to operate with the antenna types listed in the user guide with the maximum permissible gain and required antenna impedance for each antenna type indicated. Antenna types not included in this list, having a gain greater than the maximum gain indicated for that type, are strictly prohibited for use with this device.

### Concernant les EVMs avec antennes détachables

Conformément à la réglementation d'Industrie Canada, le présent émetteur radio peut fonctionner avec une antenne d'un type et d'un gain maximal (ou inférieur) approuvé pour l'émetteur par Industrie Canada. Dans le but de réduire les risques de brouillage radioélectrique à l'intention des autres utilisateurs, il faut choisir le type d'antenne et son gain de sorte que la puissance isotrope rayonnée équivalente (p.i.r.e.) ne dépasse pas l'intensité nécessaire à l'établissement d'une communication satisfaisante. Le présent émetteur radio a été approuvé par Industrie Canada pour fonctionner avec les types d'antenne énumérés dans le manuel d'usage et ayant un gain admissible maximal et l'impédance requise pour chaque type d'antenne. Les types d'antenne non inclus dans cette liste, ou dont le gain est supérieur au gain maximal indiqué, sont strictement interdits pour l'exploitation de l'émetteur.

#### 3.3 Japan

3.3.1 *Notice for EVMs delivered in Japan:* Please see [http://www.tij.co.jp/lstds/ti\\_ja/general/eStore/notice\\_01.page](http://www.tij.co.jp/lstds/ti_ja/general/eStore/notice_01.page) 日本国内に輸入される評価用キット、ボードについては、次のところをご覧ください。  
[http://www.tij.co.jp/lstds/ti\\_ja/general/eStore/notice\\_01.page](http://www.tij.co.jp/lstds/ti_ja/general/eStore/notice_01.page)

3.3.2 *Notice for Users of EVMs Considered "Radio Frequency Products" in Japan:* EVMs entering Japan may not be certified by TI as conforming to Technical Regulations of Radio Law of Japan.

If User uses EVMs in Japan, not certified to Technical Regulations of Radio Law of Japan, User is required to follow the instructions set forth by Radio Law of Japan, which includes, but is not limited to, the instructions below with respect to EVMs (which for the avoidance of doubt are stated strictly for convenience and should be verified by User):

1. Use EVMs in a shielded room or any other test facility as defined in the notification #173 issued by Ministry of Internal Affairs and Communications on March 28, 2006, based on Sub-section 1.1 of Article 6 of the Ministry's Rule for Enforcement of Radio Law of Japan,
2. Use EVMs only after User obtains the license of Test Radio Station as provided in Radio Law of Japan with respect to EVMs, or
3. Use of EVMs only after User obtains the Technical Regulations Conformity Certification as provided in Radio Law of Japan with respect to EVMs. Also, do not transfer EVMs, unless User gives the same notice above to the transferee. Please note that if User does not follow the instructions above, User will be subject to penalties of Radio Law of Japan.

【無線電波を送信する製品の開発キットをお使いになる際の注意事項】 開発キットの中には技術基準適合証明を受けていないものがあります。技術適合証明を受けていないものご使用に際しては、電波法遵守のため、以下のいずれかの措置を取っていただく必要がありますのでご注意ください。

1. 電波法施行規則第6条第1項第1号に基づく平成18年3月28日総務省告示第173号で定められた電波暗室等の試験設備でご使用いただく。
2. 実験局の免許を取得後ご使用いただく。
3. 技術基準適合証明を取得後ご使用いただく。

なお、本製品は、上記の「ご使用にあたっての注意」を譲渡先、移転先に通知しない限り、譲渡、移転できないものとします。

上記を遵守頂けない場合は、電波法の罰則が適用される可能性があることをご留意ください。日本テキサス・インスツルメンツ株式会社  
東京都新宿区西新宿 6 丁目 2 4 番 1 号  
西新宿三井ビル

3.3.3 *Notice for EVMs for Power Line Communication:* Please see [http://www.tij.co.jp/lstds/ti\\_ja/general/eStore/notice\\_02.page](http://www.tij.co.jp/lstds/ti_ja/general/eStore/notice_02.page)  
電力線搬送波通信についての開発キットをお使いになる際の注意事項については、次のところをご覧ください。[http://www.tij.co.jp/lstds/ti\\_ja/general/eStore/notice\\_02.page](http://www.tij.co.jp/lstds/ti_ja/general/eStore/notice_02.page)

#### 3.4 European Union

3.4.1 *For EVMs subject to EU Directive 2014/30/EU (Electromagnetic Compatibility Directive):*

This is a class A product intended for use in environments other than domestic environments that are connected to a low-voltage power-supply network that supplies buildings used for domestic purposes. In a domestic environment this product may cause radio interference in which case the user may be required to take adequate measures.



- 
- 4 *EVM Use Restrictions and Warnings:*
    - 4.1 EVMS ARE NOT FOR USE IN FUNCTIONAL SAFETY AND/OR SAFETY CRITICAL EVALUATIONS, INCLUDING BUT NOT LIMITED TO EVALUATIONS OF LIFE SUPPORT APPLICATIONS.
    - 4.2 User must read and apply the user guide and other available documentation provided by TI regarding the EVM prior to handling or using the EVM, including without limitation any warning or restriction notices. The notices contain important safety information related to, for example, temperatures and voltages.
    - 4.3 *Safety-Related Warnings and Restrictions:*
      - 4.3.1 User shall operate the EVM within TI's recommended specifications and environmental considerations stated in the user guide, other available documentation provided by TI, and any other applicable requirements and employ reasonable and customary safeguards. Exceeding the specified performance ratings and specifications (including but not limited to input and output voltage, current, power, and environmental ranges) for the EVM may cause personal injury or death, or property damage. If there are questions concerning performance ratings and specifications, User should contact a TI field representative prior to connecting interface electronics including input power and intended loads. Any loads applied outside of the specified output range may also result in unintended and/or inaccurate operation and/or possible permanent damage to the EVM and/or interface electronics. Please consult the EVM user guide prior to connecting any load to the EVM output. If there is uncertainty as to the load specification, please contact a TI field representative. During normal operation, even with the inputs and outputs kept within the specified allowable ranges, some circuit components may have elevated case temperatures. These components include but are not limited to linear regulators, switching transistors, pass transistors, current sense resistors, and heat sinks, which can be identified using the information in the associated documentation. When working with the EVM, please be aware that the EVM may become very warm.
      - 4.3.2 EVMs are intended solely for use by technically qualified, professional electronics experts who are familiar with the dangers and application risks associated with handling electrical mechanical components, systems, and subsystems. User assumes all responsibility and liability for proper and safe handling and use of the EVM by User or its employees, affiliates, contractors or designees. User assumes all responsibility and liability to ensure that any interfaces (electronic and/or mechanical) between the EVM and any human body are designed with suitable isolation and means to safely limit accessible leakage currents to minimize the risk of electrical shock hazard. User assumes all responsibility and liability for any improper or unsafe handling or use of the EVM by User or its employees, affiliates, contractors or designees.
    - 4.4 User assumes all responsibility and liability to determine whether the EVM is subject to any applicable international, federal, state, or local laws and regulations related to User's handling and use of the EVM and, if applicable, User assumes all responsibility and liability for compliance in all respects with such laws and regulations. User assumes all responsibility and liability for proper disposal and recycling of the EVM consistent with all applicable international, federal, state, and local requirements.
  5. *Accuracy of Information:* To the extent TI provides information on the availability and function of EVMs, TI attempts to be as accurate as possible. However, TI does not warrant the accuracy of EVM descriptions, EVM availability or other information on its websites as accurate, complete, reliable, current, or error-free.
  6. *Disclaimers:*
    - 6.1 EXCEPT AS SET FORTH ABOVE, EVMS AND ANY MATERIALS PROVIDED WITH THE EVM (INCLUDING, BUT NOT LIMITED TO, REFERENCE DESIGNS AND THE DESIGN OF THE EVM ITSELF) ARE PROVIDED "AS IS" AND "WITH ALL FAULTS." TI DISCLAIMS ALL OTHER WARRANTIES, EXPRESS OR IMPLIED, REGARDING SUCH ITEMS, INCLUDING BUT NOT LIMITED TO ANY EPIDEMIC FAILURE WARRANTY OR IMPLIED WARRANTIES OF MERCHANTABILITY OR FITNESS FOR A PARTICULAR PURPOSE OR NON-INFRINGEMENT OF ANY THIRD PARTY PATENTS, COPYRIGHTS, TRADE SECRETS OR OTHER INTELLECTUAL PROPERTY RIGHTS.
    - 6.2 EXCEPT FOR THE LIMITED RIGHT TO USE THE EVM SET FORTH HEREIN, NOTHING IN THESE TERMS SHALL BE CONSTRUED AS GRANTING OR CONFERRING ANY RIGHTS BY LICENSE, PATENT, OR ANY OTHER INDUSTRIAL OR INTELLECTUAL PROPERTY RIGHT OF TI, ITS SUPPLIERS/LICENSORS OR ANY OTHER THIRD PARTY, TO USE THE EVM IN ANY FINISHED END-USER OR READY-TO-USE FINAL PRODUCT, OR FOR ANY INVENTION, DISCOVERY OR IMPROVEMENT, REGARDLESS OF WHEN MADE, CONCEIVED OR ACQUIRED.
  7. *USER'S INDEMNITY OBLIGATIONS AND REPRESENTATIONS.* USER WILL DEFEND, INDEMNIFY AND HOLD TI, ITS LICENSORS AND THEIR REPRESENTATIVES HARMLESS FROM AND AGAINST ANY AND ALL CLAIMS, DAMAGES, LOSSES, EXPENSES, COSTS AND LIABILITIES (COLLECTIVELY, "CLAIMS") ARISING OUT OF OR IN CONNECTION WITH ANY HANDLING OR USE OF THE EVM THAT IS NOT IN ACCORDANCE WITH THESE TERMS. THIS OBLIGATION SHALL APPLY WHETHER CLAIMS ARISE UNDER STATUTE, REGULATION, OR THE LAW OF TORT, CONTRACT OR ANY OTHER LEGAL THEORY, AND EVEN IF THE EVM FAILS TO PERFORM AS DESCRIBED OR EXPECTED.
-

8. *Limitations on Damages and Liability:*

8.1 *General Limitations.* IN NO EVENT SHALL TI BE LIABLE FOR ANY SPECIAL, COLLATERAL, INDIRECT, PUNITIVE, INCIDENTAL, CONSEQUENTIAL, OR EXEMPLARY DAMAGES IN CONNECTION WITH OR ARISING OUT OF THESE TERMS OR THE USE OF THE EVMS , REGARDLESS OF WHETHER TI HAS BEEN ADVISED OF THE POSSIBILITY OF SUCH DAMAGES. EXCLUDED DAMAGES INCLUDE, BUT ARE NOT LIMITED TO, COST OF REMOVAL OR REINSTALLATION, ANCILLARY COSTS TO THE PROCUREMENT OF SUBSTITUTE GOODS OR SERVICES, RETESTING, OUTSIDE COMPUTER TIME, LABOR COSTS, LOSS OF GOODWILL, LOSS OF PROFITS, LOSS OF SAVINGS, LOSS OF USE, LOSS OF DATA, OR BUSINESS INTERRUPTION. NO CLAIM, SUIT OR ACTION SHALL BE BROUGHT AGAINST TI MORE THAN TWELVE (12) MONTHS AFTER THE EVENT THAT GAVE RISE TO THE CAUSE OF ACTION HAS OCCURRED.

8.2 *Specific Limitations.* IN NO EVENT SHALL TI'S AGGREGATE LIABILITY FROM ANY USE OF AN EVM PROVIDED HEREUNDER, INCLUDING FROM ANY WARRANTY, INDEMNITY OR OTHER OBLIGATION ARISING OUT OF OR IN CONNECTION WITH THESE TERMS, , EXCEED THE TOTAL AMOUNT PAID TO TI BY USER FOR THE PARTICULAR EVM(S) AT ISSUE DURING THE PRIOR TWELVE (12) MONTHS WITH RESPECT TO WHICH LOSSES OR DAMAGES ARE CLAIMED. THE EXISTENCE OF MORE THAN ONE CLAIM SHALL NOT ENLARGE OR EXTEND THIS LIMIT.

9. *Return Policy.* Except as otherwise provided, TI does not offer any refunds, returns, or exchanges. Furthermore, no return of EVM(s) will be accepted if the package has been opened and no return of the EVM(s) will be accepted if they are damaged or otherwise not in a resalable condition. If User feels it has been incorrectly charged for the EVM(s) it ordered or that delivery violates the applicable order, User should contact TI. All refunds will be made in full within thirty (30) working days from the return of the components(s), excluding any postage or packaging costs.

10. *Governing Law:* These terms and conditions shall be governed by and interpreted in accordance with the laws of the State of Texas, without reference to conflict-of-laws principles. User agrees that non-exclusive jurisdiction for any dispute arising out of or relating to these terms and conditions lies within courts located in the State of Texas and consents to venue in Dallas County, Texas. Notwithstanding the foregoing, any judgment may be enforced in any United States or foreign court, and TI may seek injunctive relief in any United States or foreign court.

Mailing Address: Texas Instruments, Post Office Box 655303, Dallas, Texas 75265  
Copyright © 2019, Texas Instruments Incorporated

## IMPORTANT NOTICE AND DISCLAIMER

TI PROVIDES TECHNICAL AND RELIABILITY DATA (INCLUDING DATA SHEETS), DESIGN RESOURCES (INCLUDING REFERENCE DESIGNS), APPLICATION OR OTHER DESIGN ADVICE, WEB TOOLS, SAFETY INFORMATION, AND OTHER RESOURCES "AS IS" AND WITH ALL FAULTS, AND DISCLAIMS ALL WARRANTIES, EXPRESS AND IMPLIED, INCLUDING WITHOUT LIMITATION ANY IMPLIED WARRANTIES OF MERCHANTABILITY, FITNESS FOR A PARTICULAR PURPOSE OR NON-INFRINGEMENT OF THIRD PARTY INTELLECTUAL PROPERTY RIGHTS.

These resources are intended for skilled developers designing with TI products. You are solely responsible for (1) selecting the appropriate TI products for your application, (2) designing, validating and testing your application, and (3) ensuring your application meets applicable standards, and any other safety, security, regulatory or other requirements.

These resources are subject to change without notice. TI grants you permission to use these resources only for development of an application that uses the TI products described in the resource. Other reproduction and display of these resources is prohibited. No license is granted to any other TI intellectual property right or to any third party intellectual property right. TI disclaims responsibility for, and you will fully indemnify TI and its representatives against, any claims, damages, costs, losses, and liabilities arising out of your use of these resources.

TI's products are provided subject to [TI's Terms of Sale](#) or other applicable terms available either on [ti.com](http://ti.com) or provided in conjunction with such TI products. TI's provision of these resources does not expand or otherwise alter TI's applicable warranties or warranty disclaimers for TI products.

TI objects to and rejects any additional or different terms you may have proposed.

Mailing Address: Texas Instruments, Post Office Box 655303, Dallas, Texas 75265  
Copyright © 2022, Texas Instruments Incorporated