

SN54SC3T98-SEP Total Ionizing Dose (TID) Report



ABSTRACT

This report covers the Radiation Lot Acceptance Testing (RLAT) results of the SN54SC3T98-SEP radiation tolerant, configurable multiple-function gate. The study was done to determine Total Ionizing Dose (TID) effects under high dose rate (HDR) to 30 krad(Si). Radiation Lot Acceptance Testing (RLAT) was performed using 5 units at a dose level of 30 krad(Si) per MIL-STD-883 TM 1019, and all future wafer lots will be tested to the same conditions.

The SN54SC3T98-SEP is packaged in a space enhanced plastic for low outgassing characteristics and is Single Event Latch-Up (SEL) immune up to 43 MeV-cm²/mg, which makes the device an option for low Earth orbit space applications.

For full total ionizing dose characterization results, see [SN54SC4T125-SEP Total Ionizing Dose \(TID\) Report](#).

Table of Contents

1 Device Information	2
1.1 Device Details.....	2
2 Total Dose Test Setup	3
2.1 Test Overview.....	3
2.2 Test Description and Facilities.....	3
2.3 Test Setup Details.....	3
2.4 Test Configuration and Condition.....	4
3 TID Characterization Test Results	5
3.1 TID Characterization Summary Results.....	5
3.2 Specification Compliance Matrix.....	5
4 Reference Documents	7
5 Appendix: HDR TID Report Data	8

List of Figures

Figure 2-1. SN54SC3T98-SEP Bias Diagram.....	3
--	---

List of Tables

Table 1-1. Device and Exposure Details.....	2
Table 2-1. HDR Device Information.....	4
Table 3-1. Electrical Parameters Table.....	5

Trademarks

All trademarks are the property of their respective owners.

1 Device Information

The SN54SC3T98-SEP device features configurable multiple functions with extended voltage operation to allow for level translation. The output state is determined by eight patterns of 3-bit input. The user can choose the logic functions MUX, AND, OR, NAND, NOR, inverter, and non-inverter. The output level is referenced to the supply voltage (V_{CC}) and supports 1.2-V, 1.8-V, 2.5-V, 3.3-V, and 5-V CMOS levels.

The input is designed with a lower threshold circuit to support up translation for lower voltage CMOS inputs (for example, 1.2-V input to 1.8-V output or 1.8-V input to 3.3-V output). Additionally, the 5-V tolerant input pins enable down translation (for example, 3.3-V to 2.5-V output).

1.1 Device Details

[Table 1-1](#) lists the device information used for TID HDR Radiation Lot Acceptance Testing (RLAT).

Table 1-1. Device and Exposure Details

TID HDR Details: up to 30 krad(Si)	
TI Device Number	SN54SC3T98-SEP
Package	14-pin PW (TSSOP)
Technology	LBC9
Die Lot Number	3059498RFB
A/T Lot Number and Date Code	3615236ML3 / 36AEQRK
Quantity Tested	12 irradiated devices + 3 control
Lot Accept or Reject	Devices passed 30 krad(Si)
HDR Radiation Facility	Texas Instruments CLAB in Dallas, Texas
HDR Dose Level	30 krad(Si)
HDR Dose Rate	196.01 -rad(Si)/s ionizing radiation
HDR Radiation Source	Gammacell 220 Excel (GC-220E) Co-60
Irradiation Temperature	Ambient, room temperature

2 Total Dose Test Setup

2.1 Test Overview

The SN54SC3T98-SEP samples were irradiated at a high dose rate of 196.01 rad(Si)/s up to 30 krad(Si) and then put through full electrical parametric testing on the production Automated Test Equipment (ATE). The samples were functional and passed all electrical parametric tests with readings within data sheet electrical specification limits.

2.2 Test Description and Facilities

The SN54SC3T98-SEP HDR exposure was performed on biased devices in a Co-60 gamma cell at TI facility in Dallas, Texas. The un-attenuated dose rate of this cell is 196.01 rads(Si)/s. After exposure, the devices were packed in dry ice (per MIL-STD-883 Method 1019.9 section 3.10) and full post radiation electrical evaluation using Texas Instruments ATE was conducted. ATE test limits are set per data sheet electrical limits based on qualification and characterization data. Post radiation measurements were taken within 30 minutes of removing the devices from the dry ice container. The devices were allowed to reach room temperature prior to electrical post radiation measurements.

2.3 Test Setup Details

The devices were tested in biased conditions as described in the following sections.

2.3.1 Bias Diagram

Figure 2-1 shows the bias conditions for each pin during irradiation.

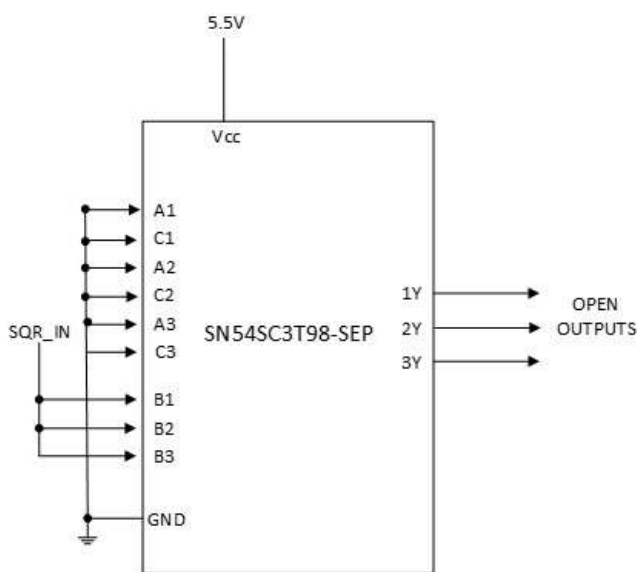

Figure 2-1. SN54SC3T98-SEP Bias Diagram

2.4 Test Configuration and Condition

The RLAT units were irradiated to 30 krad(Si), parametrically tested on ATE, and then were annealed at 25°C for 50 hours. The units were then put through parametric testing once more on the ATE. An additional six units were irradiated to 30 krad(Si) without anneal, for reference.

Table 2-1 lists the serialized samples used for TID Radiation Lot Acceptance Testing (RLAT).

Table 2-1. HDR Device Information

Control Group	HDR = 196.01 rad(Si)/s	
Total Samples: 4	Total Samples: 12	
Exposure Levels		
0 krad (Si)	30 krad(Si)	
Biased	Biased	Biased + 50 hour anneal
1 - 4	5 - 10	11 - 16

3 TID Characterization Test Results

3.1 TID Characterization Summary Results

The parametric data for the SN54SC3T98-SEP passes to 30 krad(Si) HDR TID irradiation. The drifts of the electrical parameters through HDR were within the data sheet limits.

Overall, the SN54SC3T98-SEP showed a strong degree of hardness to HDR TID irradiation up to 30 krad(Si). The measurements taken post-irradiation for each sample set showed a marginal shift for most parameters at each dose level. The parameters that did show a greater degree of change between pre- and post-irradiation were still within the electrical performance characteristics specified in the data sheet electrical parameters.

See [Section 5](#) for HDR report up to 30 krad(Si).

3.2 Specification Compliance Matrix

Table 3-1. Electrical Parameters Table

Parameter	Test Conditions	V _{CC}	T _A = -55°C to +125°C			Unit	Test Name
			MIN	TYP	MAX		
V _{T+} 1	Positive-going input threshold voltage	1.2 V to 1.3 V	0.31	0.655	1.1	V	VTP_1P2V
		1.65 V to 2 V	0.39	0.915	1.32		VTP_1P65V, VTP_2V
		2.25 V to 2.75 V	0.51	1.09	1.51		VTP_2P25V, VTP_2P75V
		3 V to 3.6 V	0.65	1.2	1.7		VTP_3V, VTP_3P6V
		4.5 V to 5.5 V	0.87	1.51	2.16		VTP_4P5V, VTP_5P5V
V _{T-} 1	Negative-going input threshold voltage	1.2 V to 1.3 V	0.11	0.349	0.622	V	VTN_1P2V
		1.65 V to 2 V	0.18	0.455	0.666		VTN_1P65V, VTN_2V
		2.25 V to 2.75 V	0.25	0.545	0.74		VTN_2P25V, VTN_2P75V
		3 V to 3.6 V	0.33	0.635	0.85		VTN_3V, VTN_3P6V
		4.5 V to 5.5 V	0.45	0.755	1.14		VTN_4P5V, VTN_5P5V
ΔV _T 1	Hysteresis (VT+ – VT–)	1.2 V to 1.3 V	0.081	0.29	0.77	V	DELTAVT_1P2V
		1.65 V to 2 V	0.21	0.43	0.88		DELTAVT_1P65V, DELTAVT_2V
		2.25 V to 2.75 V	0.25	0.54	0.91		DELTAVT_2P25V, DELTAVT_2P75V
		3 V to 3.6 V	0.31	0.63	0.91		DELTAVT_3V, DELTAVT_3P6V
		4.5 V to 5.5 V	0.43	0.75	1.1		DELTAVT_4P5V, DELTAVT_5P5V
V _{IH}	High-level input voltage	1.2 V to 1.3 V	0.78			V	VIH_1P2V, VIH_1P3V
		1.65 V to 2 V	1.1				VIH_1P65V, VIH_2V
		2.25 V to 2.75 V	1.28				VIH_2P25V, VIH_2P75V
		3 V to 3.6 V	1.45				VIH_3V, VIH_3P6V
		4.5 V to 5.5 V	2				VIH_4P5V, VIH_5P5V
V _{IL}	Low-Level input voltage	1.2 V to 1.3 V			0.18	V	VIL_1P2V, VIL_1P3V
		1.65 V to 2 V			0.51		VIL_1P65V, VIL_2V
		2.25 V to 2.75 V			0.65		VIL_2P25V, VIL_2P75V
		3 V to 3.6 V			0.75		VIL_3V, VIL_3P6V
		4.5 V to 5.5 V			0.80		VIL_4P5V, VIL_5P5V
V _{OH} 2	I _{OH} = -50 μA	1.2 V to 5.5 V	V _{CC} -0.2			V	VOH_N50UA_1P65V, VOH_N50UA_2V, VOH_N50UA_2P75V, VOH_N50UA_3P6V, VOH_N50UA_4P5V, VOH_N50UA_5P5V
	I _{OH} = -1 mA	1.2 V	0.8				VOH_N1MA_1P2V
	I _{OH} = -2 mA	1.65 V to 2 V	1.21				VOH_N2MA_1P65V, VOH_N2MA_2V
	I _{OH} = -3 mA	2.25 V to 2.75 V	1.93				VOH_N3MA_2P25V, VOH_N3MA_2P75V
	I _{OH} = -5.5 mA	3 V to 3.6 V	2.49				VOH_N5P5MA_3V, VOH_N5P5MA_3P6V
	I _{OH} = -8 mA	4.5 V to 5.5 V	3.95				VOH_N8MA_4P5V, VOH_N8MA_5P5V
	I _{OH} = -24 mA	4.5 V to 5.5 V	3.15				VOH_N24MA_4P5V, VOH_N24MA_5P5V

Table 3-1. Electrical Parameters Table (continued)

Parameter	Test Conditions	V _{CC}	T _A = -55°C to +125°C			Unit	Test Name
			MIN	TYP	MAX		
V _{OL}	I _{OL} = 50 μA	1.2 V to 5.5 V			0.1	V	VOL_50UA_1P65V, VOL_50UA_2V, VOL_50UA_2P75V,VOL_50UA_3P6V, VOL_50UA_4P5V, VOL_50UA_5P5V
	I _{OL} = 1 mA	1.2 V			0.2		VOL_1MA_1P2V
	I _{OL} = 2 mA	1.65 V to 2 V			0.25		VOL_2MA_1P65V, VOL_2MA_2V
	I _{OL} = 3 mA	2.25 V to 2.75 V			0.2		VOL_3MA_2P25V, VOL_3MA_2P75V
	I _{OL} = 5.5 mA	3 V to 3.6 V			0.25		VOL_5P5MA_3V, VOL_5P5MA_3P6V
	I _{OL} = 8 mA	4.5 V to 5.5 V			0.35		VOL_8MA_4P5V, VOL_8MA_5P5V
	I _{OL} = 24 mA	4.5 V to 5.5 V			0.75		VOL_24MA_4P5V, VOL_24MA_5P5V
I _{CC}	V _I = V _{CC} or GND, I _O = 0	1.2 V to 5.5 V		2	93	μA	ICCH_5P5V, ICCL_5P5V
ΔI _{CC}	One input at 0.3 V or 3.4 V, other inputs at V _{CC} or GND	5.5 V			1.5	mA	DELTAICC_5P5V
	One input at 0.3 V or 1.1 V, other inputs at V _{CC} or GND	1.8 V			68	μA	DELTAICC_1P8V
I _{OZ} 3	V _O = V _{CC} or GND	5.5 V			±2.5	μA	IOZ
I _I	V _I = 0 V to V _{CC}	V _I = 0 V to V _{CC}			±1	μA	IIH_5P5V, IIL_5P5V

1. Schmitt-trigger input devices only.
2. Push-pull output devices only.
3. 3-State output devices only.

4 Reference Documents

Texas Instruments total ionizing dose radiation (total dose) test procedure follows the standards put forth in MIL-STD-883 TM 1019. The document can be found at the DLA website.

5 Appendix: HDR TID Report Data

This appendix provides the SN54SC3T98-SEP TID HDR report. The report shows the variation for each parameter up to 30 krad(Si).

TID Report

SN54SC3T98-SEP

DELTAICC_1P8V	
Test Site	CLAB
Tester	ETS88-01
Test Number	EQ774601
Units	µA
Max Limit	68
Min Limit	-10

krad	Serial #	PreTestHDR	PostTestHDR	Delta	Delta %	% of Limit Range
0	1	0.902	0.988	0.09	9.59%	0.11%
0	2	0.933	0.926	-0.01	-0.76%	0.01%
0	3	1.120	0.957	-0.16	-14.56%	0.21%
0	4	1.120	1.113	-0.01	-0.63%	0.01%
30	5	1.120	14.880	13.76	1228.57%	17.64%
30	6	1.027	13.070	12.04	1172.64%	15.44%
30	7	1.151	17.690	16.54	1436.92%	21.20%
30	8	1.058	14.040	12.98	1227.03%	16.64%
30	9	1.058	11.700	10.64	1005.86%	13.64%
30	10	1.120	19.190	18.07	1613.39%	23.17%
31	11	1.120	1.082	-0.04	-3.39%	0.05%
31	12	1.027	0.988	-0.04	-3.79%	0.05%
31	13	1.151	1.019	-0.13	-11.47%	0.17%
31	14	1.058	1.082	0.02	2.27%	0.03%
31	15	1.058	0.832	-0.23	-21.36%	0.29%
31	16	1.120	1.082	-0.04	-3.39%	0.05%
Max	1.151	19.190	18.04	1613.39%	23.17%	
Average	1.071	6.290	5.22	477.31%	6.79%	
Min	0.902	0.832	-0.07	-21.36%	0.01%	
Std Dev	0.073	7.233	7.16	654.49%	9.17%	

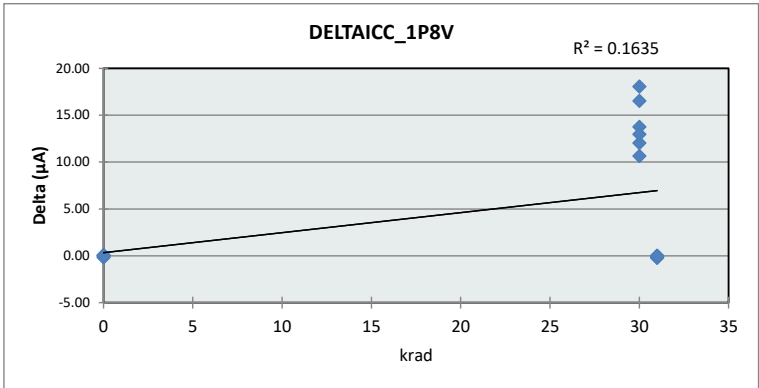

DELTAICC_1P8V			
Test Site	CLAB		
Tester	ETS88-01		
Test Number	EQ774601		
Units	µA		
Max Limit	68		
Min Limit	-10		
krad	0	30	31
LL	-10.00	-10.00	-10.00
Min	0.93	11.70	0.83
Average	1.00	15.10	1.01
Max	1.11	19.19	1.08
UL	68.00	68.00	68.00

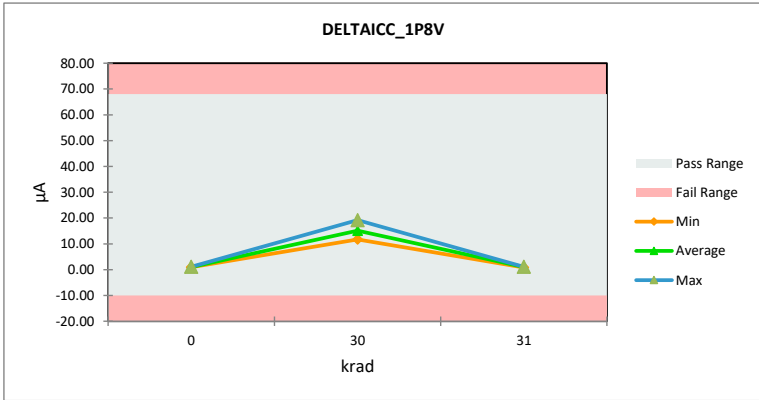

TID Report

SN54SC3T98-SEP

DELTAICC_5P5V	
Test Site	CLAB
Tester	ETS88-01
Test Number	EQ774601
Units	µA
Max Limit	1500
Min Limit	-10

krad	Serial #	PreTestHDR	PostTestHDR	Delta	Delta %	% of Limit Range
0	1	334.400	334.200	-0.20	-0.06%	0.01%
0	2	332.300	334.100	1.80	0.54%	0.12%
0	3	332.300	333.900	1.60	0.48%	0.11%
0	4	333.700	335.000	1.30	0.39%	0.09%
30	5	333.100	340.300	7.20	2.16%	0.48%
30	6	331.300	340.500	9.20	2.78%	0.61%
30	7	331.600	345.900	14.30	4.31%	0.95%
30	8	330.700	343.300	12.60	3.81%	0.83%
30	9	332.400	339.000	6.60	1.99%	0.44%
30	10	331.300	349.500	18.20	5.49%	1.21%
31	11	333.100	328.800	-4.30	-1.29%	0.28%
31	12	331.300	327.900	-3.40	-1.03%	0.23%
31	13	331.600	329.200	-2.40	-0.72%	0.16%
31	14	330.700	327.100	-3.60	-1.09%	0.24%
31	15	332.400	330.300	-2.10	-0.63%	0.14%
31	16	331.300	327.700	-3.60	-1.09%	0.24%
Max		334.400	349.500	15.10	5.49%	1.21%
Average		332.094	335.419	3.33	1.00%	0.38%
Min		330.700	327.100	-3.60	-1.29%	0.01%
Std Dev		1.067	6.988	5.92	2.16%	0.35%

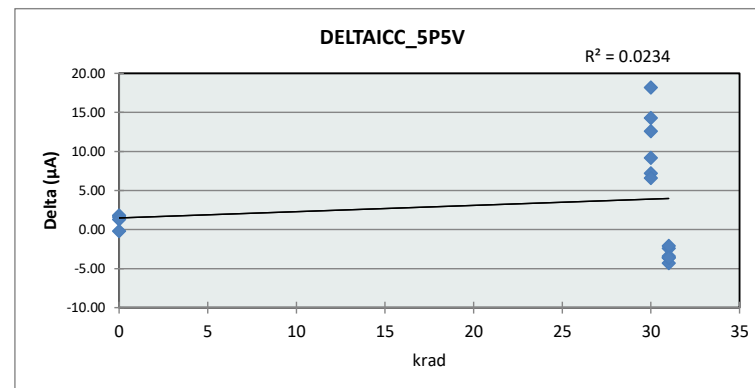

DELTAICC_5P5V			
Test Site	CLAB		
Tester	ETS88-01		
Test Number	EQ774601		
Units	µA		
Max Limit	1500		
Min Limit	-10		
krad	0	30	31
LL	-10.00	-10.00	-10.00
Min	333.90	339.00	327.10
Average	334.30	343.08	328.50
Max	335.00	349.50	330.30
UL	1500.00	1500.00	1500.00

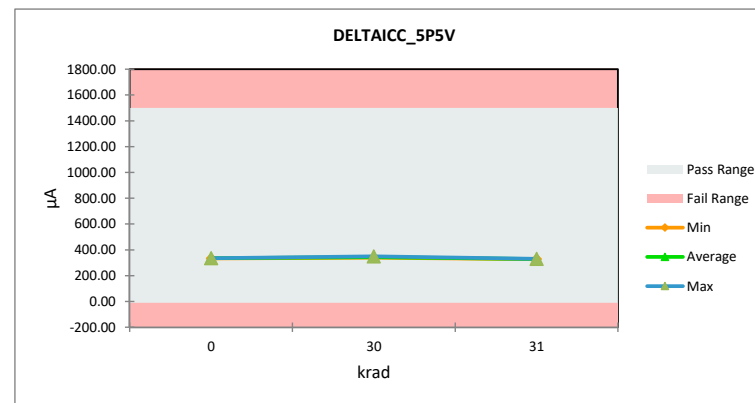

TID Report SN54SC3T98-SEP

DELTAVT_1P2V

Test Site	CLAB
Tester	ETS88-01
Test Number	EQ774601
Units	V
Max Limit	0.77
Min Limit	0.2

krad	Serial #	PreTestHDR	PostTestHDR	Delta	Delta %	% of Limit Range
0	1	0.361	0.361	0.00	0.05%	0.03%
0	2	0.361	0.363	0.00	0.43%	0.27%
0	3	0.359	0.360	0.00	0.45%	0.29%
0	4	0.359	0.361	0.00	0.33%	0.21%
30	5	0.360	0.321	-0.04	-10.60%	6.69%
30	6	0.362	0.324	-0.04	-10.40%	6.61%
30	7	0.359	0.308	-0.05	-14.18%	8.94%
30	8	0.360	0.294	-0.07	-18.26%	11.52%
30	9	0.359	0.319	-0.04	-11.15%	7.02%
30	10	0.358	0.291	-0.07	-18.72%	11.76%
31	11	0.360	0.344	-0.02	-4.25%	2.68%
31	12	0.362	0.350	-0.01	-3.39%	2.15%
31	13	0.359	0.343	-0.02	-4.54%	2.86%
31	14	0.360	0.349	-0.01	-2.87%	1.81%
31	15	0.359	0.351	-0.01	-2.10%	1.32%
31	16	0.358	0.351	-0.01	-2.08%	1.31%
Max		0.362	0.363	0.00	0.45%	11.76%
Average		0.360	0.337	-0.02	-6.33%	4.09%
Min		0.358	0.291	-0.07	-18.72%	0.03%
Std Dev		0.001	0.024	0.02	6.62%	4.06%

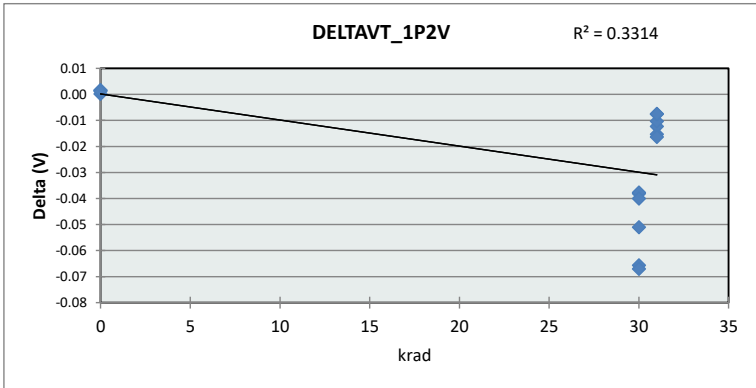

DELTAVT_1P2V			
krad	0	30	31
LL	0.20	0.20	0.20
Min	0.36	0.29	0.34
Average	0.36	0.31	0.35
Max	0.36	0.32	0.35
UL	0.77	0.77	0.77

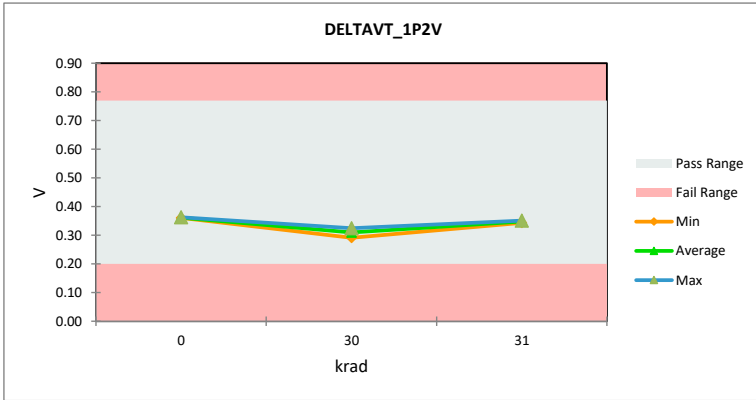

TID Report

SN54SC3T98-SEP

DELTAVT_1P65V

Test Site	CLAB
Tester	ETS88-01
Test Number	EQ774601
Units	V
Max Limit	0.88
Min Limit	0.21

krad	Serial #	PreTestHDR	PostTestHDR	Delta	Delta %	% of Limit Range
0	1	0.434	0.435	0.00	0.15%	0.10%
0	2	0.434	0.435	0.00	0.22%	0.14%
0	3	0.431	0.431	0.00	-0.08%	0.05%
0	4	0.433	0.433	0.00	-0.04%	0.03%
30	5	0.432	0.423	-0.01	-2.17%	1.40%
30	6	0.435	0.427	-0.01	-1.86%	1.21%
30	7	0.434	0.416	-0.02	-3.95%	2.56%
30	8	0.432	0.407	-0.03	-5.84%	3.77%
30	9	0.433	0.425	-0.01	-1.78%	1.15%
30	10	0.432	0.410	-0.02	-5.13%	3.30%
31	11	0.432	0.440	0.01	1.79%	1.15%
31	12	0.435	0.439	0.00	0.82%	0.53%
31	13	0.434	0.437	0.00	0.81%	0.52%
31	14	0.432	0.440	0.01	1.85%	1.20%
31	15	0.433	0.438	0.01	1.18%	0.77%
31	16	0.432	0.437	0.01	1.26%	0.81%
Max		0.435	0.440	0.00	1.85%	3.77%
Average		0.433	0.430	0.00	-0.80%	1.17%
Min		0.431	0.407	-0.02	-5.84%	0.03%
Std Dev		0.001	0.011	0.01	2.42%	1.13%

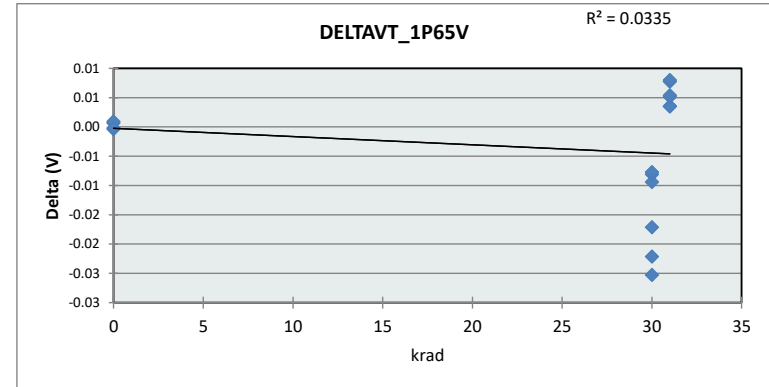

DELTAVT_1P65V	
Test Site	CLAB
Tester	ETS88-01
Test Number	EQ774601
Units	V
Max Limit	0.88
Min Limit	0.21

krad	0	30	31
LL	0.21	0.21	0.21
Min	0.43	0.41	0.44
Average	0.43	0.42	0.44
Max	0.43	0.43	0.44
UL	0.88	0.88	0.88

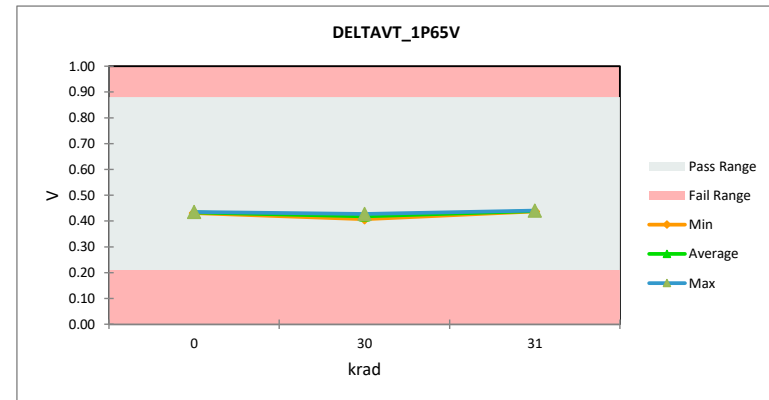

TID Report SN54SC3T98-SEP

DELTAVT_2P25V	
Test Site	CLAB
Tester	ETS88-01
Test Number	EQ774601
Units	V
Max Limit	0.91
Min Limit	0.25

krad	Serial #	PreTestHDR	PostTestHDR	Delta	Delta %	% of Limit Range
0	1	0.501	0.501	0.00	-0.04%	0.03%
0	2	0.500	0.503	0.00	0.49%	0.37%
0	3	0.499	0.499	0.00	0.05%	0.04%
0	4	0.502	0.503	0.00	0.13%	0.10%
30	5	0.501	0.505	0.00	0.90%	0.68%
30	6	0.504	0.510	0.01	1.16%	0.89%
30	7	0.502	0.507	0.01	1.13%	0.86%
30	8	0.499	0.504	0.01	1.01%	0.76%
30	9	0.502	0.507	0.00	0.98%	0.74%
30	10	0.501	0.506	0.00	0.86%	0.65%
31	11	0.501	0.509	0.01	1.76%	1.34%
31	12	0.504	0.510	0.01	1.24%	0.95%
31	13	0.502	0.508	0.01	1.30%	0.99%
31	14	0.499	0.511	0.01	2.43%	1.83%
31	15	0.502	0.509	0.01	1.37%	1.04%
31	16	0.501	0.508	0.01	1.36%	1.03%
Max		0.504	0.511	0.01	2.43%	1.83%
Average		0.501	0.506	0.01	1.01%	0.77%
Min		0.499	0.499	0.00	-0.04%	0.03%
Std Dev		0.002	0.004	0.00	0.64%	0.48%

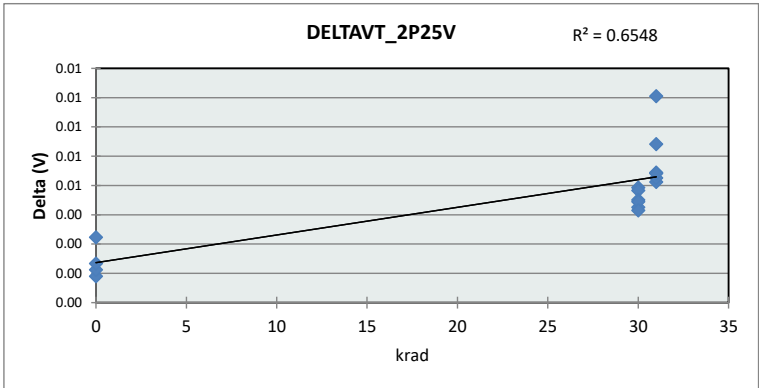

DELTAVT_2P25V			
Test Site	CLAB		
Tester	ETS88-01		
Test Number	EQ774601		
Units	V		
Max Limit	0.91		
Min Limit	0.25		
krad	0	30	31
LL	0.25	0.25	0.25
Min	0.50	0.50	0.51
Average	0.50	0.51	0.51
Max	0.50	0.51	0.51
UL	0.91	0.91	0.91

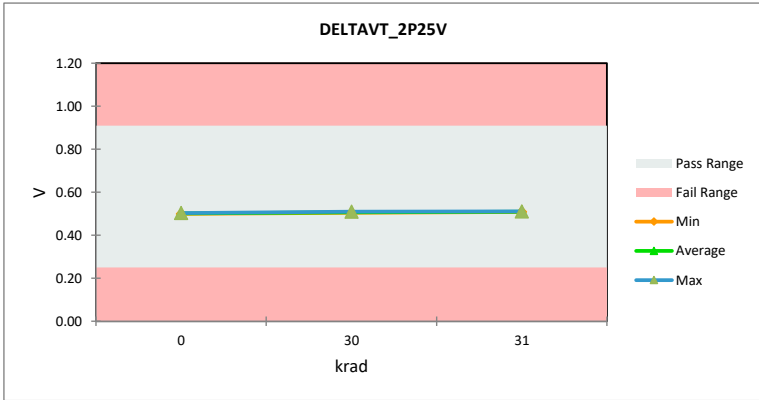

TID Report SN54SC3T98-SEP

DELTAVT_2P75V	
Test Site	CLAB
Tester	ETS88-01
Test Number	EQ774601
Units	V
Max Limit	0.91
Min Limit	0.25

krad	Serial #	PreTestHDR	PostTestHDR	Delta	Delta %	% of Limit Range
0	1	0.550	0.549	0.00	-0.30%	0.25%
0	2	0.551	0.552	0.00	0.10%	0.08%
0	3	0.550	0.549	0.00	-0.04%	0.03%
0	4	0.552	0.552	0.00	0.04%	0.03%
30	5	0.550	0.559	0.01	1.52%	1.27%
30	6	0.553	0.558	0.01	0.92%	0.77%
30	7	0.553	0.558	0.00	0.86%	0.72%
30	8	0.550	0.558	0.01	1.33%	1.11%
30	9	0.549	0.556	0.01	1.25%	1.04%
30	10	0.551	0.556	0.00	0.80%	0.67%
31	11	0.550	0.560	0.01	1.77%	1.48%
31	12	0.553	0.557	0.00	0.85%	0.71%
31	13	0.553	0.558	0.00	0.79%	0.67%
31	14	0.550	0.558	0.01	1.47%	1.22%
31	15	0.549	0.557	0.01	1.49%	1.24%
31	16	0.551	0.557	0.01	1.06%	0.88%
Max		0.553	0.560	0.01	1.77%	1.48%
Average		0.551	0.556	0.00	0.87%	0.76%
Min		0.549	0.549	0.00	-0.30%	0.03%
Std Dev		0.001	0.003	0.00	0.63%	0.46%

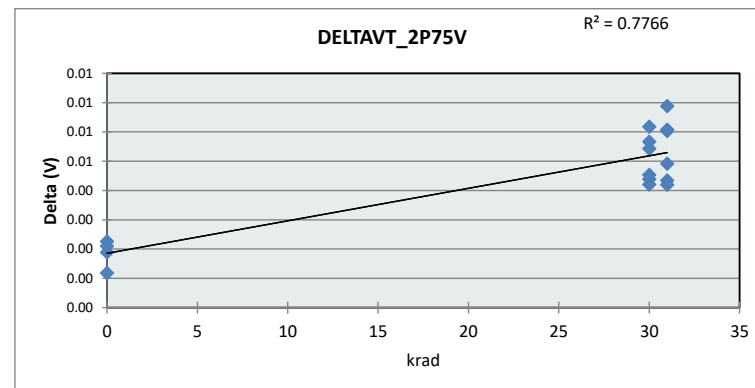

DELTAVT_2P75V			
Test Site	CLAB		
Tester	ETS88-01		
Test Number	EQ774601		
Units	V		
Max Limit	0.91		
Min Limit	0.25		
krad	0	30	31
LL	0.25	0.25	0.25
Min	0.55	0.56	0.56
Average	0.55	0.56	0.56
Max	0.55	0.56	0.56
UL	0.91	0.91	0.91

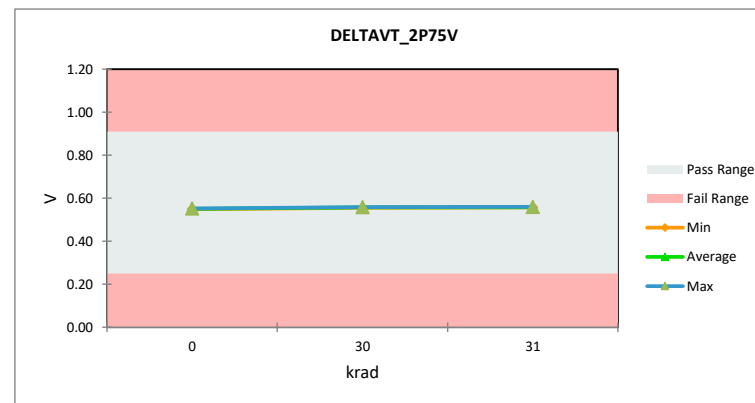

TID Report SN54SC3T98-SEP

DELTA_VT_2V	
Test Site	CLAB
Tester	ETS88-01
Test Number	EQ774601
Units	V
Max Limit	0.88
Min Limit	0.21

krad	Serial #	PreTestHDR	PostTestHDR	Delta	Delta %	% of Limit Range
0	1	0.474	0.474	0.00	-0.09%	0.06%
0	2	0.474	0.475	0.00	0.07%	0.05%
0	3	0.472	0.472	0.00	0.12%	0.08%
0	4	0.472	0.474	0.00	0.53%	0.38%
30	5	0.471	0.476	0.00	1.05%	0.74%
30	6	0.475	0.481	0.01	1.08%	0.77%
30	7	0.474	0.474	0.00	-0.03%	0.02%
30	8	0.471	0.471	0.00	-0.06%	0.04%
30	9	0.472	0.475	0.00	0.68%	0.48%
30	10	0.474	0.474	0.00	0.01%	0.01%
31	11	0.471	0.482	0.01	2.41%	1.70%
31	12	0.475	0.482	0.01	1.39%	0.99%
31	13	0.474	0.481	0.01	1.43%	1.01%
31	14	0.471	0.482	0.01	2.40%	1.69%
31	15	0.472	0.481	0.01	1.91%	1.35%
31	16	0.474	0.481	0.01	1.54%	1.09%
Max		0.475	0.482	0.01	2.41%	1.70%
Average		0.473	0.477	0.00	0.90%	0.65%
Min		0.471	0.471	0.00	-0.09%	0.01%
Std Dev		0.002	0.004	0.00	0.88%	0.60%

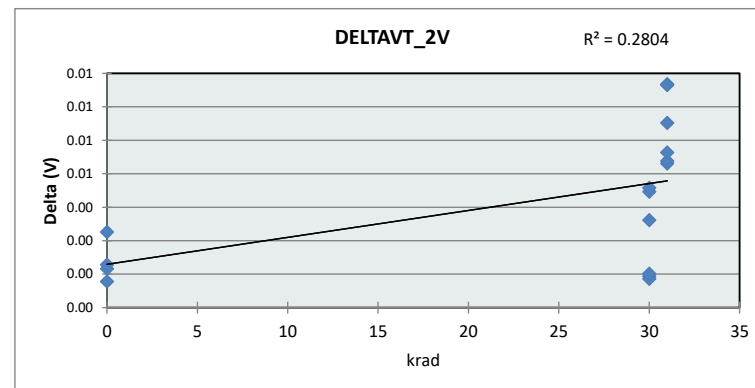

DELTA_VT_2V			
Test Site	CLAB		
Tester	ETS88-01		
Test Number	EQ774601		
Units	V		
Max Limit	0.88		
Min Limit	0.21		
krad	0	30	31
LL	0.21	0.21	0.21
Min	0.47	0.47	0.48
Average	0.47	0.48	0.48
Max	0.47	0.48	0.48
UL	0.88	0.88	0.88

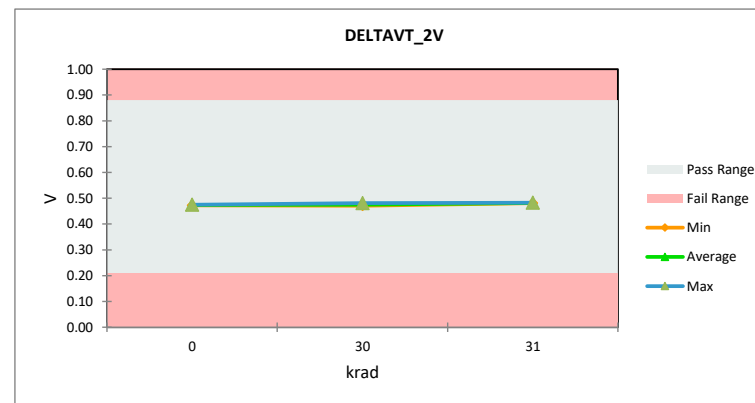

TID Report SN54SC3T98-SEP

DELTAVT_3P6V	
Test Site	CLAB
Tester	ETS88-01
Test Number	EQ774601
Units	V
Max Limit	0.91
Min Limit	0.31

krad	Serial #	PreTestHDR	PostTestHDR	Delta	Delta %	% of Limit Range
0	1	0.632	0.631	0.00	-0.20%	0.21%
0	2	0.633	0.635	0.00	0.24%	0.26%
0	3	0.636	0.635	0.00	-0.11%	0.11%
0	4	0.636	0.636	0.00	0.05%	0.06%
30	5	0.633	0.637	0.00	0.66%	0.70%
30	6	0.634	0.636	0.00	0.28%	0.30%
30	7	0.636	0.637	0.00	0.16%	0.17%
30	8	0.635	0.639	0.00	0.71%	0.75%
30	9	0.633	0.637	0.00	0.67%	0.71%
30	10	0.636	0.638	0.00	0.37%	0.39%
31	11	0.633	0.635	0.00	0.32%	0.34%
31	12	0.634	0.636	0.00	0.36%	0.38%
31	13	0.636	0.638	0.00	0.35%	0.38%
31	14	0.635	0.639	0.00	0.68%	0.72%
31	15	0.633	0.634	0.00	0.27%	0.29%
31	16	0.636	0.637	0.00	0.29%	0.31%
Max		0.636	0.639	0.00	0.71%	0.75%
Average		0.634	0.636	0.00	0.32%	0.38%
Min		0.632	0.631	0.00	-0.20%	0.06%
Std Dev		0.001	0.002	0.00	0.27%	0.22%

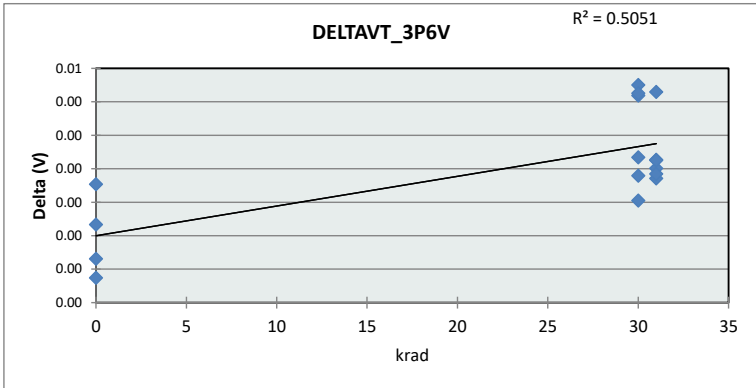

DELTAVT_3P6V		0	30	31
Test Site	CLAB			
Tester	ETS88-01			
Test Number	EQ774601			
Units	V			
Max Limit	0.91			
Min Limit	0.31			
LL		0.31	0.31	0.31
Min		0.63	0.64	0.63
Average		0.63	0.64	0.64
Max		0.64	0.64	0.64
UL		0.91	0.91	0.91

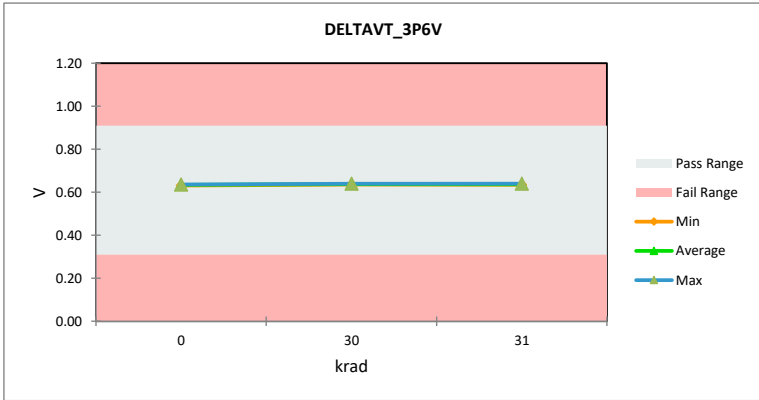

TID Report SN54SC3T98-SEP

DELTAVT_3V	
Test Site	CLAB
Tester	ETS88-01
Test Number	EQ774601
Units	V
Max Limit	0.91
Min Limit	0.31

krad	Serial #	PreTestHDR	PostTestHDR	Delta	Delta %	% of Limit Range
0	1	0.574	0.575	0.00	0.15%	0.14%
0	2	0.575	0.575	0.00	0.03%	0.03%
0	3	0.576	0.574	0.00	-0.23%	0.22%
0	4	0.577	0.577	0.00	-0.02%	0.02%
30	5	0.575	0.584	0.01	1.51%	1.45%
30	6	0.577	0.581	0.00	0.69%	0.66%
30	7	0.578	0.581	0.00	0.47%	0.45%
30	8	0.576	0.583	0.01	1.23%	1.18%
30	9	0.576	0.582	0.01	1.02%	0.98%
30	10	0.576	0.581	0.00	0.86%	0.83%
31	11	0.575	0.583	0.01	1.40%	1.35%
31	12	0.577	0.580	0.00	0.56%	0.54%
31	13	0.578	0.582	0.00	0.57%	0.55%
31	14	0.576	0.582	0.01	1.03%	0.99%
31	15	0.576	0.581	0.01	0.91%	0.87%
31	16	0.576	0.580	0.00	0.82%	0.78%
Max		0.578	0.584	0.01	1.51%	1.45%
Average		0.576	0.580	0.00	0.69%	0.69%
Min		0.574	0.574	0.00	-0.23%	0.02%
Std Dev		0.001	0.003	0.00	0.51%	0.45%

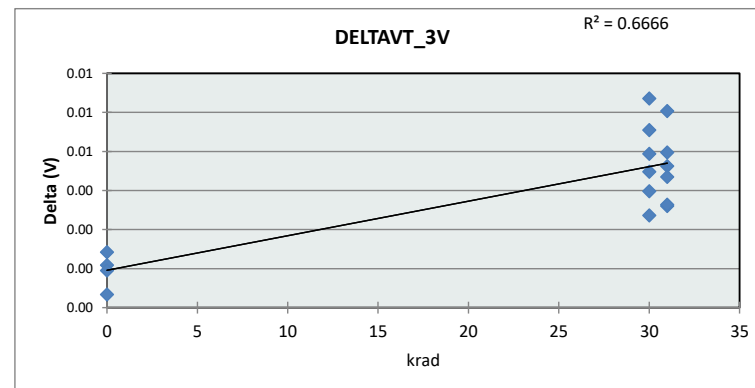

DELTAVT_3V			
Test Site	CLAB		
Tester	ETS88-01		
Test Number	EQ774601		
Units	V		
Max Limit	0.91		
Min Limit	0.31		
krad	0	30	31
LL	0.31	0.31	0.31
Min	0.57	0.58	0.58
Average	0.58	0.58	0.58
Max	0.58	0.58	0.58
UL	0.91	0.91	0.91

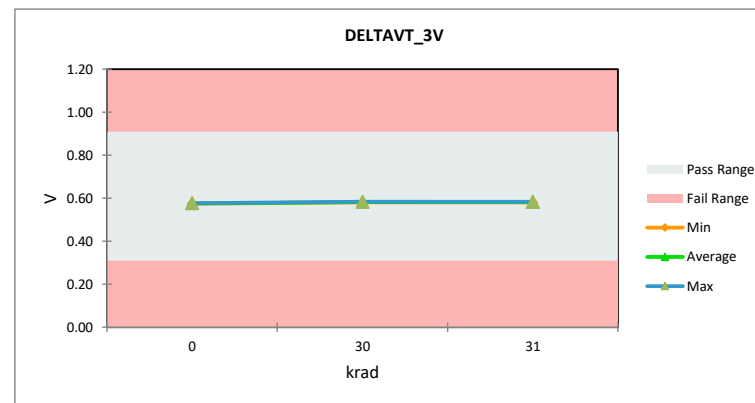

TID Report SN54SC3T98-SEP

DELTAVT_4P5V	
Test Site	CLAB
Tester	ETS88-01
Test Number	EQ774601
Units	V
Max Limit	1.1
Min Limit	0.43

krad	Serial #	PreTestHDR	PostTestHDR	Delta	Delta %	% of Limit Range
0	1	0.721	0.720	0.00	-0.05%	0.05%
0	2	0.725	0.725	0.00	0.08%	0.08%
0	3	0.726	0.723	0.00	-0.50%	0.54%
0	4	0.725	0.724	0.00	-0.02%	0.03%
30	5	0.725	0.723	0.00	-0.26%	0.28%
30	6	0.724	0.723	0.00	-0.21%	0.23%
30	7	0.727	0.728	0.00	0.11%	0.12%
30	8	0.728	0.728	0.00	0.03%	0.04%
30	9	0.722	0.721	0.00	-0.12%	0.13%
30	10	0.725	0.725	0.00	-0.06%	0.06%
31	11	0.725	0.722	0.00	-0.42%	0.45%
31	12	0.724	0.723	0.00	-0.16%	0.18%
31	13	0.727	0.728	0.00	0.09%	0.10%
31	14	0.728	0.726	0.00	-0.17%	0.19%
31	15	0.722	0.722	0.00	0.03%	0.03%
31	16	0.725	0.726	0.00	0.08%	0.09%
Max		0.728	0.728	0.00	0.11%	0.54%
Average		0.725	0.724	0.00	-0.10%	0.16%
Min		0.721	0.720	0.00	-0.50%	0.03%
Std Dev		0.002	0.002	0.00	0.18%	0.15%

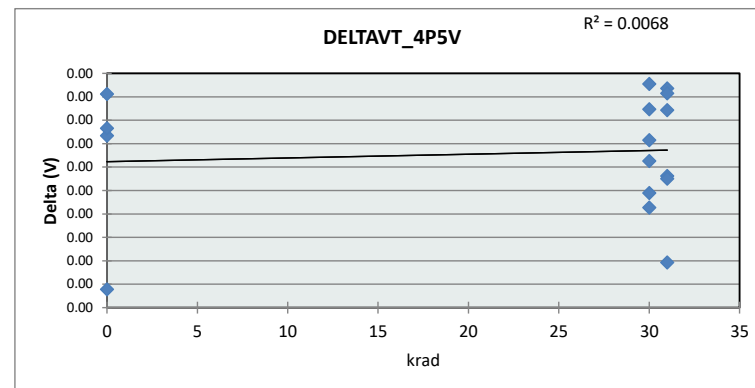

DELTAVT_4P5V		0	30	31
Test Site	CLAB			
Tester	ETS88-01			
Test Number	EQ774601			
Units	V			
Max Limit	1.1			
Min Limit	0.43			
LL		0.43	0.43	0.43
Min		0.72	0.72	0.72
Average		0.72	0.72	0.72
Max		0.73	0.73	0.73
UL		1.10	1.10	1.10

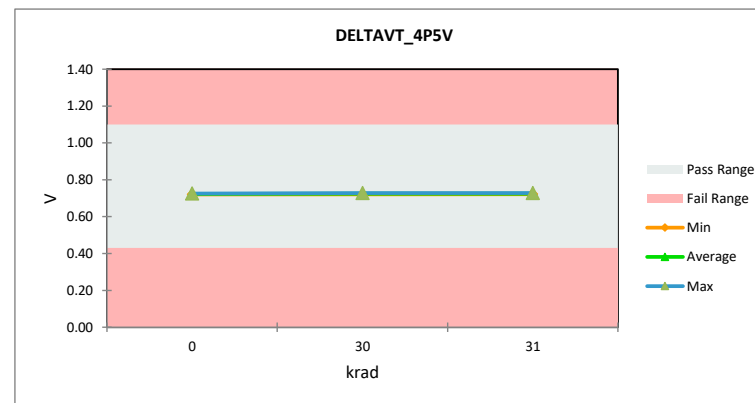

TID Report SN54SC3T98-SEP

DELTAVT_5P5V	
Test Site	CLAB
Tester	ETS88-01
Test Number	EQ774601
Units	V
Max Limit	1.1
Min Limit	0.43

krad	Serial #	PreTestHDR	PostTestHDR	Delta	Delta %	% of Limit Range
0	1	0.821	0.822	0.00	0.14%	0.17%
0	2	0.830	0.827	0.00	-0.39%	0.49%
0	3	0.830	0.827	0.00	-0.26%	0.32%
0	4	0.831	0.831	0.00	0.11%	0.14%
30	5	0.826	0.827	0.00	0.16%	0.19%
30	6	0.827	0.825	0.00	-0.18%	0.22%
30	7	0.831	0.831	0.00	-0.02%	0.03%
30	8	0.830	0.830	0.00	-0.04%	0.04%
30	9	0.823	0.822	0.00	-0.10%	0.12%
30	10	0.828	0.827	0.00	-0.07%	0.09%
31	11	0.826	0.826	0.00	-0.01%	0.01%
31	12	0.827	0.826	0.00	-0.09%	0.11%
31	13	0.831	0.831	0.00	0.01%	0.01%
31	14	0.830	0.831	0.00	0.09%	0.11%
31	15	0.823	0.823	0.00	-0.02%	0.02%
31	16	0.828	0.827	0.00	-0.07%	0.09%
Max		0.831	0.831	0.00	0.16%	0.49%
Average		0.827	0.827	0.00	-0.05%	0.14%
Min		0.821	0.822	0.00	-0.39%	0.01%
Std Dev		0.003	0.003	0.00	0.14%	0.13%

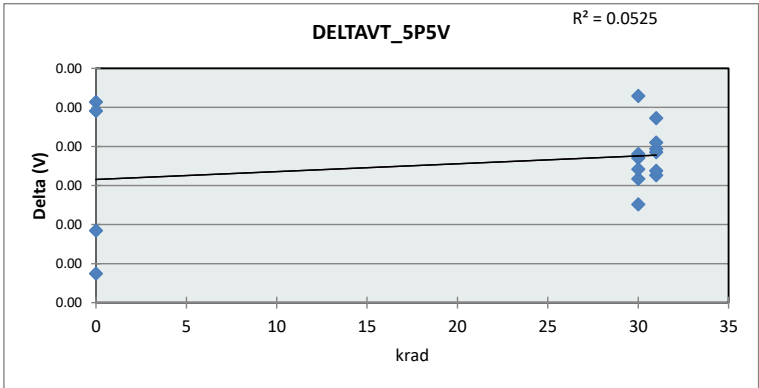

DELTAVT_5P5V			
Test Site	CLAB		
Tester	ETS88-01		
Test Number	EQ774601		
Units	V		
Max Limit	1.1		
Min Limit	0.43		
krad	0	30	31
LL	0.43	0.43	0.43
Min	0.82	0.82	0.82
Average	0.83	0.83	0.83
Max	0.83	0.83	0.83
UL	1.10	1.10	1.10

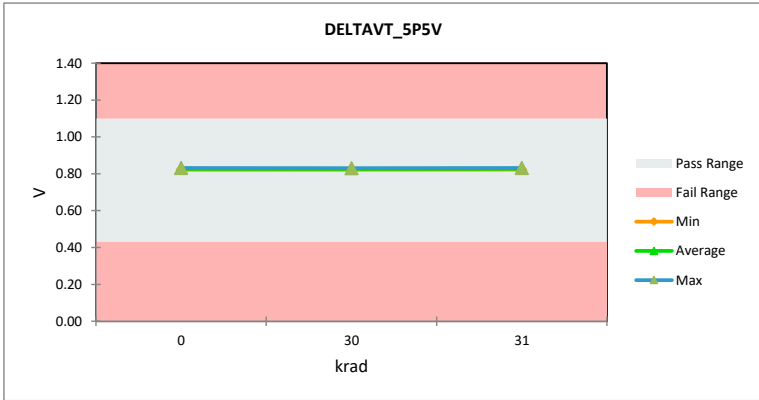

TID Report SN54SC3T98-SEP

ICC	
Test Site	CLAB
Tester	ETS88-01
Test Number	EQ774601
Units	µA
Max Limit	93
Min Limit	-1

krad	Serial #	PreTestHDR	PostTestHDR	Delta	Delta %	% of Limit Range
0	1	0.128	0.136	0.01	6.75%	0.01%
0	2	0.136	0.180	0.04	32.65%	0.05%
0	3	0.132	0.193	0.06	45.69%	0.06%
0	4	0.120	0.164	0.04	36.58%	0.05%
30	5	0.108	107.300	107.19	99251.85%	114.03%
30	6	0.101	100.300	100.20	99403.97%	106.59%
30	7	0.131	125.700	125.57	96074.45%	133.58%
30	8	0.113	106.900	106.79	94168.08%	113.60%
30	9	0.115	102.600	102.48	88885.26%	109.03%
30	10	0.141	125.100	124.96	88623.40%	132.94%
31	11	0.108	1.318	1.21	1120.37%	1.29%
31	12	0.101	1.173	1.07	1063.69%	1.14%
31	13	0.131	1.258	1.13	862.51%	1.20%
31	14	0.113	0.981	0.87	765.43%	0.92%
31	15	0.115	1.116	1.00	867.91%	1.06%
31	16	0.141	1.563	1.42	1008.51%	1.51%
Max		0.141	125.700	125.56	99403.97%	133.58%
Average		0.121	42.249	42.13	35763.57%	44.82%
Min		0.101	0.136	0.04	6.75%	0.01%
Std Dev		0.013	55.635	55.62	46993.38%	59.19%

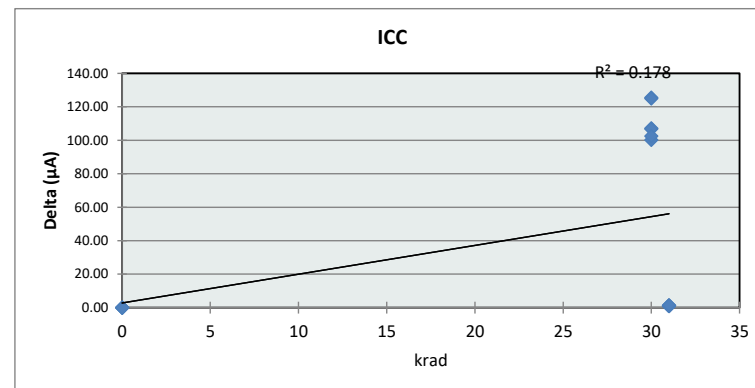

ICC		0	30	31
Test Site	CLAB			
Tester	ETS88-01			
Test Number	EQ774601			
Units	µA			
Max Limit	93			
Min Limit	-1			
krad		0	30	31
LL		-1.00	-1.00	-1.00
Min		0.14	100.30	0.98
Average		0.17	111.32	1.23
Max		0.19	125.70	1.56
UL		93.00	93.00	93.00

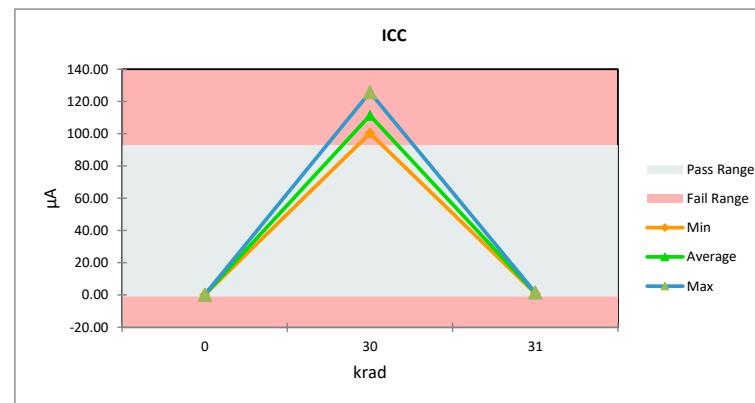

TID Report SN54SC3T98-SEP

IIH_5p5V	
Test Site	CLAB
Tester	ETS88-01
Test Number	EQ774601
Units	µA
Max Limit	1
Min Limit	-1

krad	Serial #	PreTestHDR	PostTestHDR	Delta	Delta %	% of Limit Range
0	1	0.002	0.005	0.00	102.71%	0.13%
0	2	0.003	0.008	0.00	174.15%	0.24%
0	3	0.003	0.017	0.01	490.42%	0.71%
0	4	0.003	0.008	0.00	166.75%	0.24%
30	5	0.003	0.007	0.00	137.58%	0.19%
30	6	0.003	0.006	0.00	108.22%	0.15%
30	7	0.003	0.005	0.00	72.59%	0.11%
30	8	0.003	0.009	0.01	234.83%	0.32%
30	9	0.003	0.007	0.00	152.82%	0.21%
30	10	0.003	0.006	0.00	124.50%	0.18%
31	11	0.003	0.005	0.00	63.81%	0.09%
31	12	0.003	0.003	0.00	17.64%	0.02%
31	13	0.003	0.003	0.00	4.54%	0.01%
31	14	0.003	0.005	0.00	100.11%	0.13%
31	15	0.003	0.003	0.00	15.89%	0.02%
31	16	0.003	0.003	0.00	1.60%	0.00%
Max		0.003	0.017	0.01	490.42%	0.71%
Average		0.003	0.006	0.00	123.01%	0.17%
Min		0.002	0.003	0.00	1.60%	0.00%
Std Dev		0.000	0.003	0.00	118.79%	0.17%

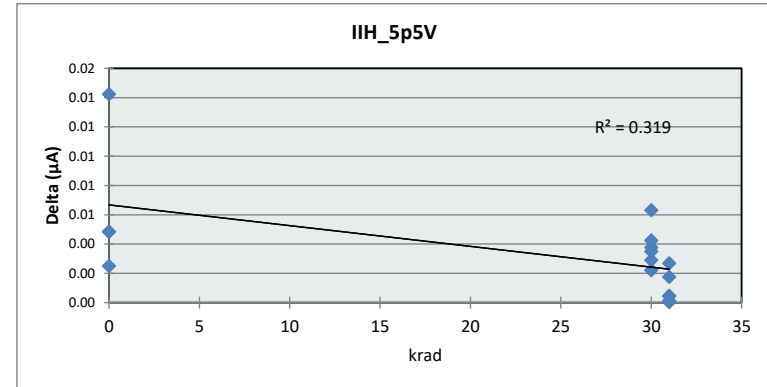

IIH_5p5V		0	30	31
Test Site	CLAB			
Tester	ETS88-01			
Test Number	EQ774601			
Units	µA			
Max Limit	1			
Min Limit	-1			
LL		-1.00	-1.00	-1.00
Min		0.00	0.01	0.00
Average		0.01	0.01	0.00
Max		0.02	0.01	0.01
UL		1.00	1.00	1.00

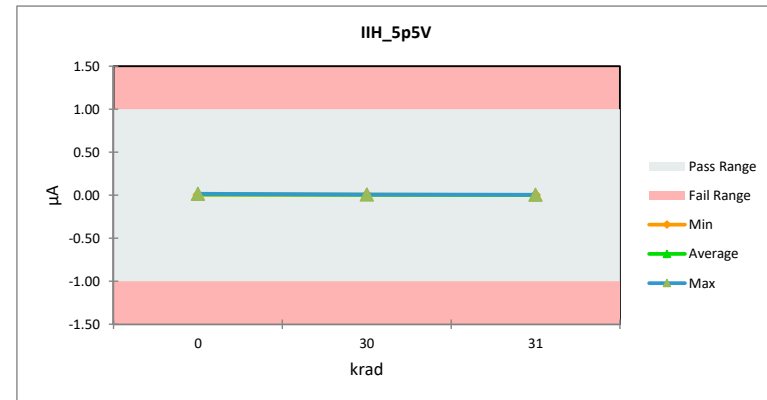

TID Report
SN54SC3T98-SEP

IIL_5p5V

Test Site	CLAB
Tester	ETS88-01
Test Number	EQ774601
Units	μA
Max Limit	1
Min Limit	-1

krad	Serial #	PreTestHDR	PostTestHDR	Delta	Delta %	% of Limit Range
0	1	0.000	0.000	0.00	180.09%	0.01%
0	2	0.000	-0.001	0.00	290.17%	0.05%
0	3	0.000	-0.001	0.00	237.14%	0.03%
0	4	-0.001	-0.001	0.00	140.25%	0.04%
30	5	0.000	0.000	0.00	64.76%	0.01%
30	6	0.000	0.000	0.00	-147.52%	0.03%
30	7	-0.001	0.000	0.00	-68.18%	0.02%
30	8	-0.001	0.000	0.00	-31.80%	0.01%
30	9	0.000	0.000	0.00	-52.80%	0.01%
30	10	0.000	0.000	0.00	-61.06%	0.01%
31	11	0.000	0.000	0.00	50.70%	0.01%
31	12	0.000	0.000	0.00	23.41%	0.00%
31	13	-0.001	0.000	0.00	-53.98%	0.02%
31	14	-0.001	0.000	0.00	-71.57%	0.02%
31	15	0.000	-0.001	0.00	54.50%	0.01%
31	16	0.000	0.000	0.00	-36.30%	0.01%
	Max	0.000	0.000	0.00	290.17%	0.05%
	Average	0.000	0.000	0.00	32.36%	0.02%
	Min	-0.001	-0.001	0.00	-147.52%	0.00%
	Std Dev	0.000	0.000	0.00	123.66%	0.01%

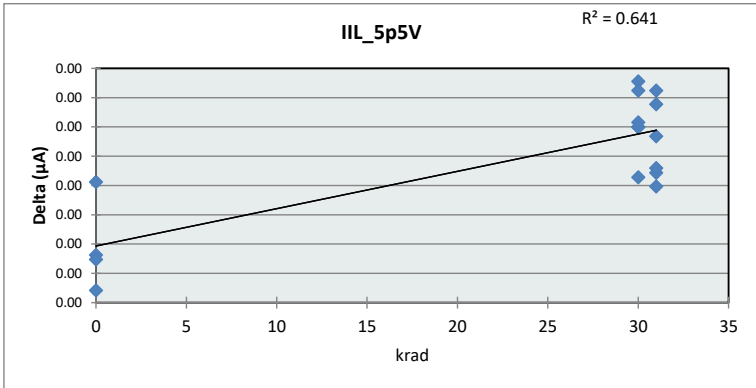

IIL_5p5V

Test Site	CLAB
Tester	ETS88-01
Test Number	EQ774601
Units	μA
Max Limit	1
Min Limit	-1

	0	30	31
LL	-1.00	-1.00	-1.00
Min	0.00	0.00	0.00
Average	0.00	0.00	0.00
Max	0.00	0.00	0.00
UL	1.00	1.00	1.00

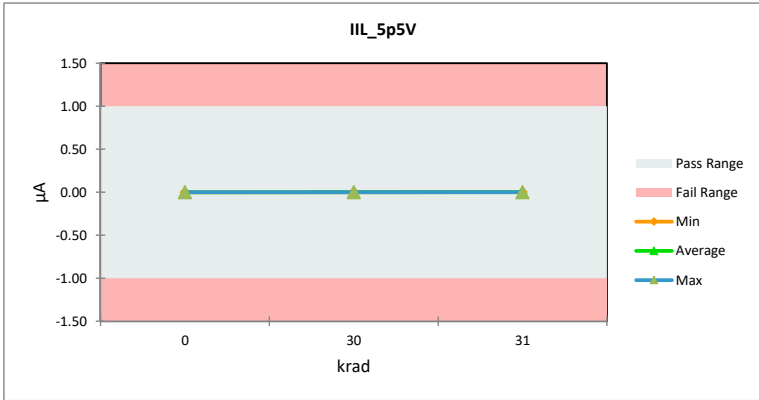

TID Report SN54SC3T98-SEP

VOH_N1MA_1P2V

Test Site	CLAB
Tester	ETS88-01
Test Number	EQ774601
Units	V
Max Limit	1.3
Min Limit	0.8

krad	Serial #	PreTestHDR	PostTestHDR	Delta	Delta %	% of Limit Range
0	1	1.136	1.137	0.00	0.01%	0.03%
0	2	1.136	1.136	0.00	0.00%	0.01%
0	3	1.136	1.136	0.00	0.01%	0.02%
0	4	1.136	1.136	0.00	0.00%	0.01%
30	5	1.136	1.135	0.00	-0.08%	0.19%
30	6	1.136	1.135	0.00	-0.10%	0.23%
30	7	1.136	1.135	0.00	-0.05%	0.12%
30	8	1.136	1.135	0.00	-0.10%	0.22%
30	9	1.136	1.135	0.00	-0.09%	0.20%
30	10	1.136	1.135	0.00	-0.08%	0.19%
31	11	1.136	1.135	0.00	-0.08%	0.19%
31	12	1.136	1.135	0.00	-0.08%	0.17%
31	13	1.136	1.135	0.00	-0.06%	0.13%
31	14	1.136	1.135	0.00	-0.08%	0.18%
31	15	1.136	1.135	0.00	-0.10%	0.22%
31	16	1.136	1.135	0.00	-0.08%	0.19%
Max		1.136	1.137	0.00	0.01%	0.23%
Average		1.136	1.135	0.00	-0.06%	0.14%
Min		1.136	1.135	0.00	-0.10%	0.01%
Std Dev		0.000	0.000	0.00	0.04%	0.08%

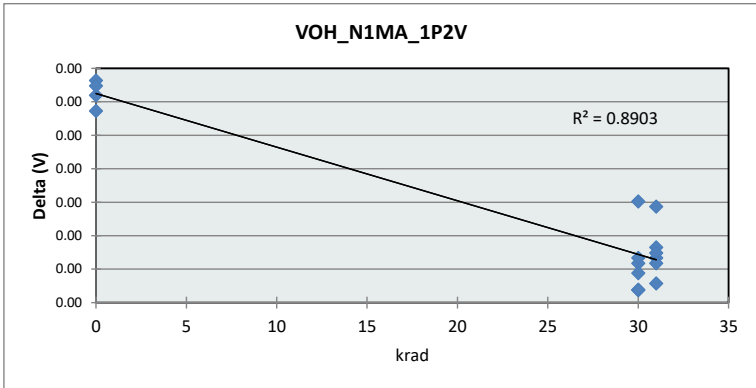

VOH_N1MA_1P2V			
Test Site	CLAB		
Tester	ETS88-01		
Test Number	EQ774601		
Units	V		
Max Limit	1.3		
Min Limit	0.8		
krad	0	30	31
LL	0.80	0.80	0.80
Min	1.14	1.13	1.14
Average	1.14	1.14	1.14
Max	1.14	1.14	1.14
UL	1.30	1.30	1.30

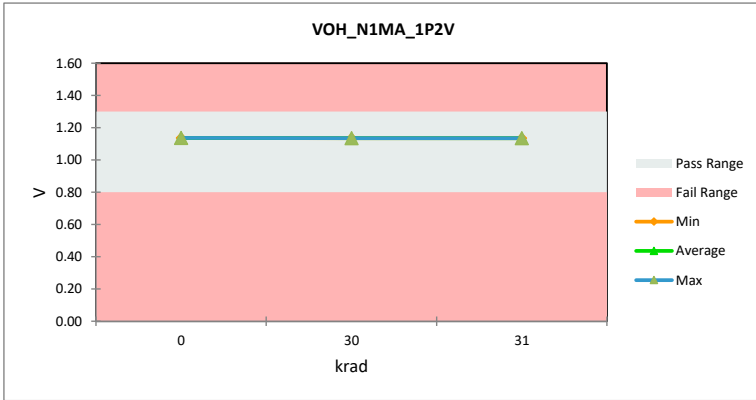

TID Report SN54SC3T98-SEP

VOH_N2MA_1P65V	
Test Site	CLAB
Tester	ETS88-01
Test Number	EQ774601
Units	V
Max Limit	1.75
Min Limit	1.2

krad	Serial #	PreTestHDR	PostTestHDR	Delta	Delta %	% of Limit Range
0	1	1.570	1.569	0.00	-0.02%	0.06%
0	2	1.569	1.570	0.00	0.03%	0.10%
0	3	1.569	1.570	0.00	0.04%	0.12%
0	4	1.569	1.569	0.00	0.01%	0.04%
30	5	1.569	1.568	0.00	-0.06%	0.17%
30	6	1.569	1.568	0.00	-0.09%	0.26%
30	7	1.568	1.568	0.00	0.01%	0.02%
30	8	1.569	1.568	0.00	-0.02%	0.06%
30	9	1.569	1.568	0.00	-0.05%	0.13%
30	10	1.569	1.569	0.00	-0.02%	0.05%
31	11	1.569	1.568	0.00	-0.05%	0.14%
31	12	1.569	1.568	0.00	-0.05%	0.16%
31	13	1.568	1.568	0.00	-0.01%	0.02%
31	14	1.569	1.568	0.00	-0.02%	0.05%
31	15	1.569	1.568	0.00	-0.03%	0.09%
31	16	1.569	1.568	0.00	-0.02%	0.07%
Max		1.570	1.570	0.00	0.04%	0.26%
Average		1.569	1.569	0.00	-0.02%	0.10%
Min		1.568	1.568	0.00	-0.09%	0.02%
Std Dev		0.000	0.001	0.00	0.04%	0.06%

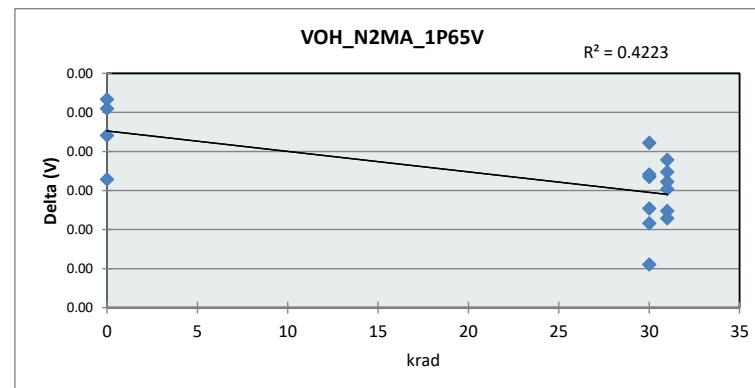

VOH_N2MA_1P65V	
Test Site	CLAB
Tester	ETS88-01
Test Number	EQ774601
Units	V
Max Limit	1.75
Min Limit	1.2

krad	0	30	31
LL	1.20	1.20	1.20
Min	1.57	1.57	1.57
Average	1.57	1.57	1.57
Max	1.57	1.57	1.57
UL	1.75	1.75	1.75

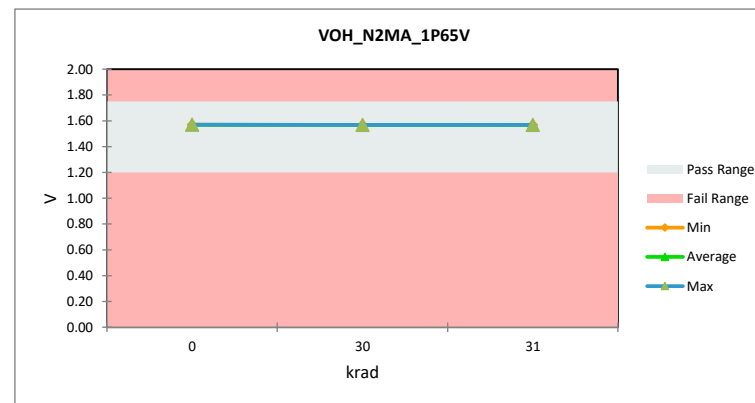

TID Report

SN54SC3T98-SEP

VOH_N3MA_2P25V	
Test Site	CLAB
Tester	ETS88-01
Test Number	EQ774601
Units	V
Max Limit	2.35
Min Limit	1.93

krad	Serial #	PreTestHDR	PostTestHDR	Delta	Delta %	% of Limit Range
0	1	2.158	2.158	0.00	-0.01%	0.06%
0	2	2.158	2.158	0.00	0.01%	0.06%
0	3	2.158	2.158	0.00	0.03%	0.14%
0	4	2.157	2.158	0.00	0.01%	0.06%
30	5	2.158	2.157	0.00	-0.04%	0.19%
30	6	2.157	2.156	0.00	-0.07%	0.34%
30	7	2.157	2.157	0.00	0.01%	0.04%
30	8	2.157	2.157	0.00	-0.02%	0.13%
30	9	2.157	2.157	0.00	-0.02%	0.12%
30	10	2.157	2.157	0.00	-0.03%	0.15%
31	11	2.158	2.157	0.00	-0.05%	0.25%
31	12	2.157	2.157	0.00	-0.02%	0.08%
31	13	2.157	2.157	0.00	0.00%	0.00%
31	14	2.157	2.157	0.00	-0.02%	0.11%
31	15	2.157	2.157	0.00	-0.02%	0.09%
31	16	2.157	2.157	0.00	-0.03%	0.15%
Max		2.158	2.158	0.00	0.03%	0.34%
Average		2.157	2.157	0.00	-0.02%	0.12%
Min		2.157	2.156	0.00	-0.07%	0.00%
Std Dev		0.000	0.001	0.00	0.02%	0.08%

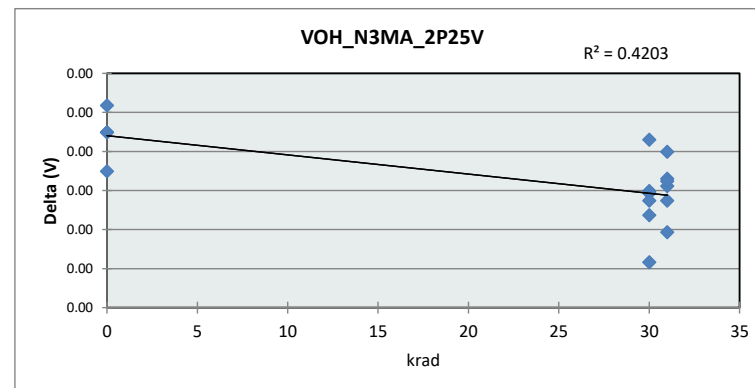

VOH_N3MA_2P25V		0	30	31
Test Site	CLAB			
Tester	ETS88-01			
Test Number	EQ774601			
Units	V			
Max Limit	2.35			
Min Limit	1.93			
krad		0	30	31
LL		1.93	1.93	1.93
Min		2.16	2.16	2.16
Average		2.16	2.16	2.16
Max		2.16	2.16	2.16
UL		2.35	2.35	2.35

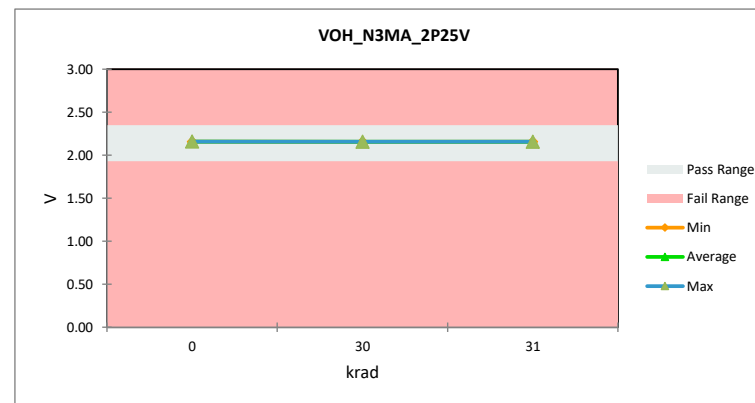

TID Report SN54SC3T98-SEP

VOH_N5P5MA_3V							
Test Site		CLAB					
Tester		ETS88-01					
Test Number		EQ774601					
Units		V					
Max Limit		3.1					
Min Limit		2.49					
krad	Serial #	PreTestHDR	PostTestHDR	Delta	Delta %	% of Limit Range	
0	1	2.858	2.858	0.00	-0.01%	0.05%	
0	2	2.857	2.858	0.00	0.02%	0.11%	
0	3	2.857	2.858	0.00	0.02%	0.11%	
0	4	2.857	2.858	0.00	0.01%	0.06%	
30	5	2.857	2.856	0.00	-0.03%	0.13%	
30	6	2.857	2.854	0.00	-0.10%	0.46%	
30	7	2.856	2.857	0.00	0.01%	0.06%	
30	8	2.857	2.856	0.00	-0.01%	0.04%	
30	9	2.857	2.856	0.00	-0.03%	0.14%	
30	10	2.857	2.856	0.00	-0.03%	0.14%	
31	11	2.857	2.856	0.00	-0.05%	0.25%	
31	12	2.857	2.856	0.00	-0.03%	0.13%	
31	13	2.856	2.856	0.00	0.00%	0.02%	
31	14	2.857	2.856	0.00	-0.01%	0.05%	
31	15	2.857	2.856	0.00	-0.03%	0.14%	
31	16	2.857	2.856	0.00	-0.04%	0.16%	
Max		2.858	2.858	0.00	0.02%	0.46%	
Average		2.857	2.856	0.00	-0.02%	0.13%	
Min		2.856	2.854	0.00	-0.10%	0.02%	
Std Dev		0.000	0.001	0.00	0.03%	0.11%	

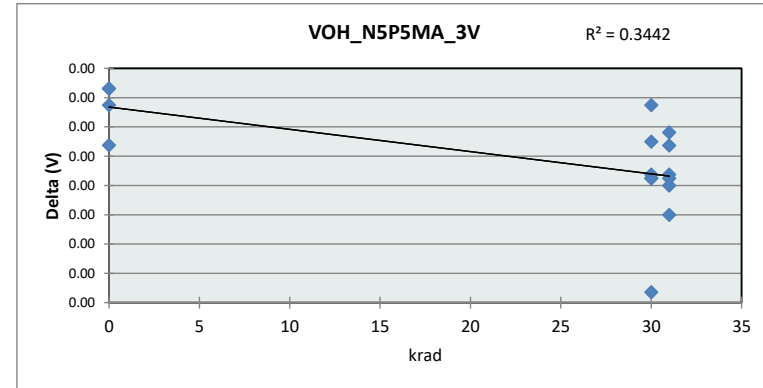

VOH_N5P5MA_3V			
Test Site		CLAB	
Tester		ETS88-01	
Test Number		EQ774601	
Units		V	
Max Limit		3.1	
Min Limit		2.49	
krad	0	30	31
LL	2.49	2.49	2.49
Min	2.86	2.85	2.86
Average	2.86	2.86	2.86
Max	2.86	2.86	2.86
UL	3.10	3.10	3.10

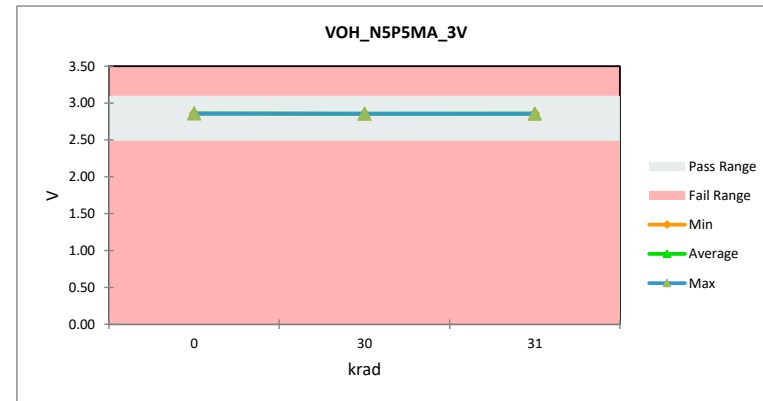

TID Report

SN54SC3T98-SEP

VOH_N8MA_4P5V	
Test Site	CLAB
Tester	ETS88-01
Test Number	EQ774601
Units	V
Max Limit	4.6
Min Limit	3.95

krad	Serial #	PreTestHDR	PostTestHDR	Delta	Delta %	% of Limit Range
0	1	4.327	4.327	0.00	-0.01%	0.08%
0	2	4.326	4.327	0.00	0.02%	0.11%
0	3	4.326	4.327	0.00	0.02%	0.14%
0	4	4.326	4.326	0.00	0.01%	0.08%
30	5	4.326	4.325	0.00	-0.01%	0.08%
30	6	4.326	4.322	0.00	-0.09%	0.59%
30	7	4.325	4.325	0.00	0.01%	0.07%
30	8	4.326	4.325	0.00	-0.01%	0.07%
30	9	4.326	4.324	0.00	-0.04%	0.24%
30	10	4.326	4.325	0.00	-0.01%	0.08%
31	11	4.326	4.324	0.00	-0.04%	0.28%
31	12	4.326	4.325	0.00	-0.01%	0.06%
31	13	4.325	4.325	0.00	0.00%	0.02%
31	14	4.326	4.325	0.00	-0.01%	0.10%
31	15	4.326	4.324	0.00	-0.04%	0.26%
31	16	4.326	4.325	0.00	-0.01%	0.09%
Max		4.327	4.327	0.00	0.02%	0.59%
Average		4.326	4.325	0.00	-0.01%	0.15%
Min		4.325	4.322	0.00	-0.09%	0.02%
Std Dev		0.001	0.001	0.00	0.03%	0.14%

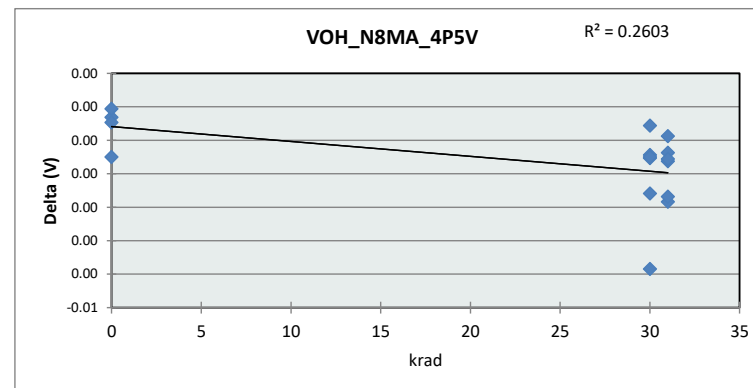

VOH_N8MA_4P5V		0	30	31
Test Site	CLAB			
Tester	ETS88-01			
Test Number	EQ774601			
Units	V			
Max Limit	4.6			
Min Limit	3.95			
krad		0	30	31
LL		3.95	3.95	3.95
Min		4.33	4.32	4.32
Average		4.33	4.32	4.32
Max		4.33	4.33	4.33
UL		4.60	4.60	4.60

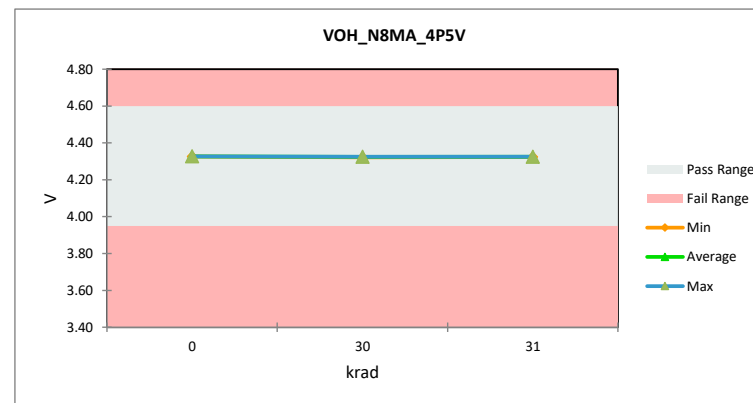

TID Report
 SN54SC3T98-SEP

VOH_N24MA_4P5V	
Test Site	CLAB
Tester	ETS88-01
Test Number	EQ774601
Units	V
Max Limit	4.6
Min Limit	3.15

krad	Serial #	PreTestHDR	PostTestHDR	Delta	Delta %	% of Limit Range
0	1	3.964	3.963	0.00	-0.03%	0.07%
0	2	3.961	3.964	0.00	0.07%	0.18%
0	3	3.961	3.963	0.00	0.07%	0.18%
0	4	3.960	3.962	0.00	0.05%	0.13%
30	5	3.960	3.957	0.00	-0.07%	0.20%
30	6	3.959	3.947	-0.01	-0.30%	0.81%
30	7	3.957	3.959	0.00	0.04%	0.12%
30	8	3.958	3.958	0.00	-0.01%	0.02%
30	9	3.959	3.956	0.00	-0.10%	0.27%
30	10	3.960	3.957	0.00	-0.06%	0.15%
31	11	3.960	3.954	-0.01	-0.15%	0.41%
31	12	3.959	3.957	0.00	-0.04%	0.10%
31	13	3.957	3.958	0.00	0.01%	0.04%
31	14	3.958	3.957	0.00	-0.03%	0.08%
31	15	3.959	3.956	0.00	-0.10%	0.27%
31	16	3.960	3.957	0.00	-0.07%	0.18%
Max		3.964	3.964	0.00	0.07%	0.81%
Average		3.960	3.958	0.00	-0.04%	0.20%
Min		3.957	3.947	-0.01	-0.30%	0.02%
Std Dev		0.002	0.004	0.00	0.09%	0.19%

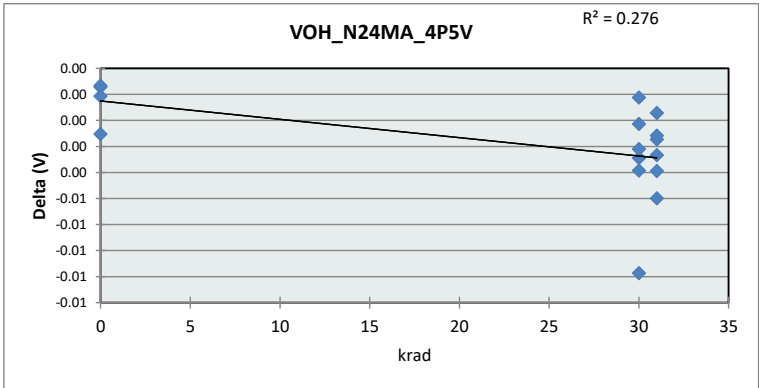

VOH_N24MA_4P5V			
Test Site	CLAB		
Tester	ETS88-01		
Test Number	EQ774601		
Units	V		
Max Limit	4.6		
Min Limit	3.15		
	0	30	31
krad			
LL	3.15	3.15	3.15
Min	3.96	3.95	3.95
Average	3.96	3.96	3.96
Max	3.96	3.96	3.96
UL	4.60	4.60	4.60

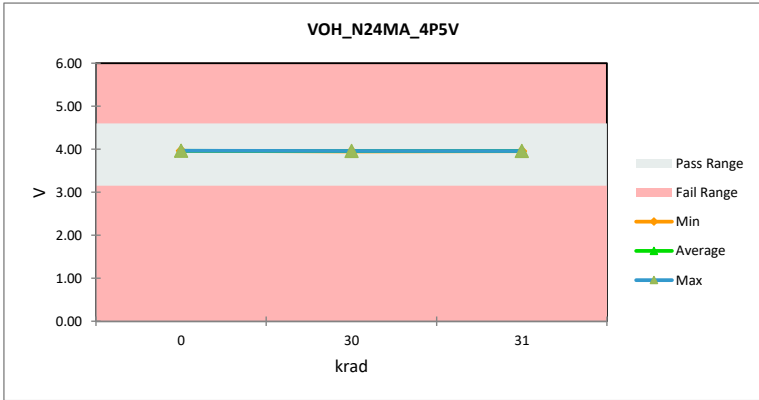

TID Report

SN54SC3T98-SEP

VOH_N24MA_5P5V

Test Site	CLAB
Tester	ETS88-01
Test Number	EQ774601
Units	V
Max Limit	5.6
Min Limit	3.15

krad	Serial #	PreTestHDR	PostTestHDR	Delta	Delta %	% of Limit Range
0	1	5.004	5.002	0.00	-0.02%	0.05%
0	2	5.001	5.003	0.00	0.04%	0.09%
0	3	5.001	5.003	0.00	0.04%	0.09%
0	4	5.000	5.002	0.00	0.03%	0.06%
30	5	5.000	4.998	0.00	-0.06%	0.12%
30	6	4.999	4.987	-0.01	-0.23%	0.48%
30	7	4.997	4.999	0.00	0.04%	0.07%
30	8	4.998	4.998	0.00	0.00%	0.00%
30	9	5.000	4.996	0.00	-0.07%	0.15%
30	10	5.000	4.998	0.00	-0.04%	0.08%
31	11	5.000	4.994	-0.01	-0.12%	0.25%
31	12	4.999	4.998	0.00	-0.03%	0.05%
31	13	4.997	4.998	0.00	0.01%	0.03%
31	14	4.998	4.998	0.00	-0.02%	0.04%
31	15	5.000	4.996	0.00	-0.08%	0.16%
31	16	5.000	4.997	0.00	-0.04%	0.09%
	Max	5.004	5.003	0.00	0.04%	0.48%
	Average	5.000	4.998	0.00	-0.03%	0.11%
	Min	4.997	4.987	-0.01	-0.23%	0.00%
	Std Dev	0.002	0.004	0.00	0.07%	0.11%

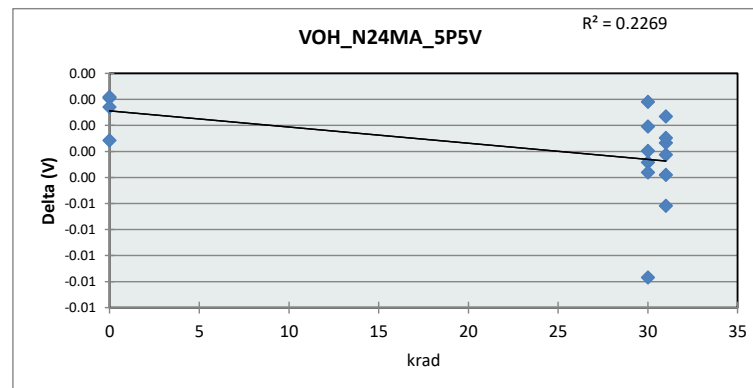

VOH_N24MA_5P5V

Test Site	CLAB
Tester	ETS88-01
Test Number	EQ774601
Units	V
Max Limit	5.6
Min Limit	3.15

krad	0	30	31
LL	3.15	3.15	3.15
Min	5.00	4.99	4.99
Average	5.00	5.00	5.00
Max	5.00	5.00	5.00
UL	5.60	5.60	5.60

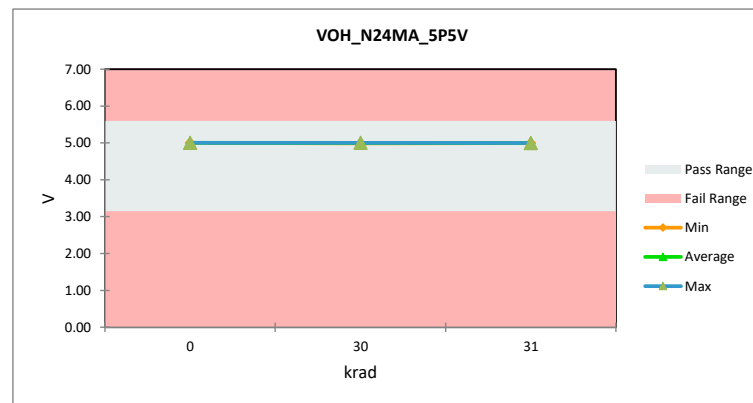

TID Report

SN54SC3T98-SEP

VOH_N50UA_1P2V	
Test Site	CLAB
Tester	ETS88-01
Test Number	EQ774601
Units	V
Max Limit	1.3
Min Limit	1

krad	Serial #	PreTestHDR	PostTestHDR	Delta	Delta %	% of Limit Range
0	1	1.197	1.197	0.00	0.00%	0.01%
0	2	1.197	1.197	0.00	0.01%	0.06%
0	3	1.197	1.197	0.00	0.01%	0.05%
0	4	1.197	1.197	0.00	0.01%	0.04%
30	5	1.197	1.197	0.00	-0.01%	0.03%
30	6	1.196	1.197	0.00	0.02%	0.08%
30	7	1.197	1.197	0.00	-0.02%	0.06%
30	8	1.197	1.197	0.00	-0.02%	0.08%
30	9	1.197	1.197	0.00	0.01%	0.03%
30	10	1.197	1.197	0.00	-0.01%	0.02%
31	11	1.197	1.197	0.00	-0.01%	0.04%
31	12	1.196	1.197	0.00	0.01%	0.05%
31	13	1.197	1.197	0.00	-0.01%	0.04%
31	14	1.197	1.197	0.00	-0.01%	0.02%
31	15	1.197	1.197	0.00	0.01%	0.05%
31	16	1.197	1.197	0.00	-0.01%	0.02%
Max		1.197	1.197	0.00	0.02%	0.08%
Average		1.197	1.197	0.00	0.00%	0.04%
Min		1.196	1.197	0.00	-0.02%	0.01%
Std Dev		0.000	0.000	0.00	0.01%	0.02%

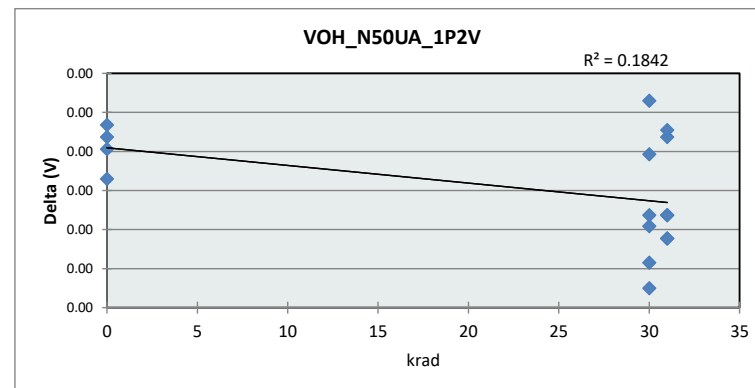

VOH_N50UA_1P2V			
Test Site	CLAB		
Tester	ETS88-01		
Test Number	EQ774601		
Units	V		
Max Limit	1.3		
Min Limit	1		
krad	0	30	31
LL	1.00	1.00	1.00
Min	1.20	1.20	1.20
Average	1.20	1.20	1.20
Max	1.20	1.20	1.20
UL	1.30	1.30	1.30

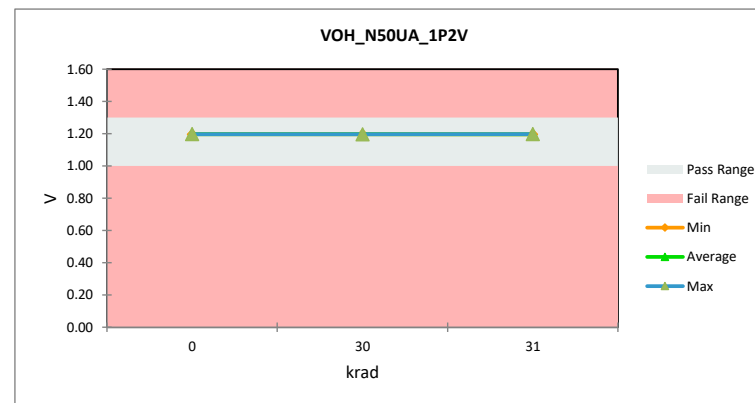

TID Report SN54SC3T98-SEP

VOH_N50UA_1P65V	
Test Site	CLAB
Tester	ETS88-01
Test Number	EQ774601
Units	V
Max Limit	1.75
Min Limit	1.55

krad	Serial #	PreTestHDR	PostTestHDR	Delta	Delta %	% of Limit Range
0	1	1.648	1.648	0.00	0.00%	0.02%
0	2	1.648	1.648	0.00	0.00%	0.01%
0	3	1.648	1.648	0.00	-0.01%	0.10%
0	4	1.648	1.648	0.00	-0.01%	0.09%
30	5	1.648	1.648	0.00	-0.02%	0.13%
30	6	1.648	1.648	0.00	0.00%	0.02%
30	7	1.648	1.648	0.00	-0.01%	0.08%
30	8	1.648	1.648	0.00	-0.01%	0.05%
30	9	1.648	1.648	0.00	0.00%	0.01%
30	10	1.648	1.648	0.00	0.00%	0.01%
31	11	1.648	1.648	0.00	-0.02%	0.13%
31	12	1.648	1.648	0.00	0.00%	0.01%
31	13	1.648	1.648	0.00	0.00%	0.04%
31	14	1.648	1.648	0.00	0.00%	0.04%
31	15	1.648	1.648	0.00	0.00%	0.04%
31	16	1.648	1.648	0.00	0.00%	0.04%
Max		1.648	1.648	0.00	0.00%	0.13%
Average		1.648	1.648	0.00	0.00%	0.05%
Min		1.648	1.648	0.00	-0.02%	0.01%
Std Dev		0.000	0.000	0.00	0.01%	0.04%

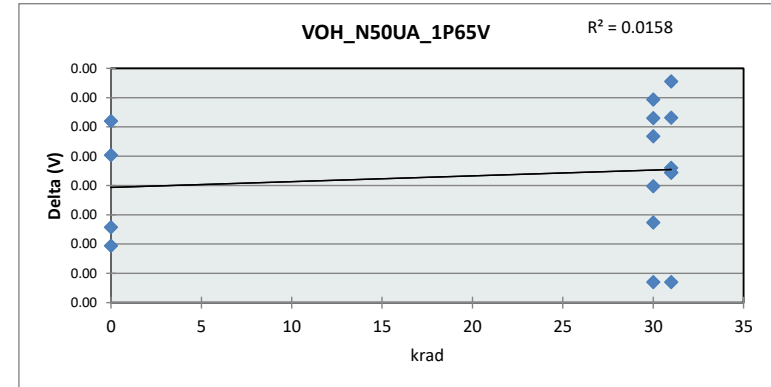

VOH_N50UA_1P65V			
Test Site	CLAB		
Tester	ETS88-01		
Test Number	EQ774601		
Units	V		
Max Limit	1.75		
Min Limit	1.55		
krad	0	30	31
LL	1.55	1.55	1.55
Min	1.65	1.65	1.65
Average	1.65	1.65	1.65
Max	1.65	1.65	1.65
UL	1.75	1.75	1.75

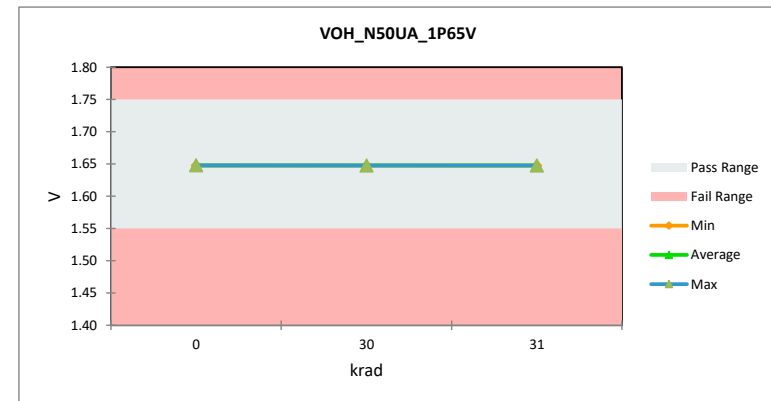

TID Report SN54SC3T98-SEP

		VOL_1MA_1P2V					
Test Site		CLAB					
Tester		ETS88-01					
Test Number		EQ774601					
Units		V					
Max Limit		0.2					
Min Limit		-0.1					
krad	Serial #	PreTestHDR	PostTestHDR	Delta	Delta %	% of Limit Range	
0	1	0.049	0.049	0.00	0.25%	0.04%	
0	2	0.049	0.049	0.00	-0.50%	0.08%	
0	3	0.049	0.049	0.00	0.04%	0.01%	
0	4	0.050	0.050	0.00	-0.07%	0.01%	
30	5	0.050	0.049	0.00	-0.76%	0.13%	
30	6	0.049	0.049	0.00	-1.20%	0.20%	
30	7	0.050	0.049	0.00	-1.26%	0.21%	
30	8	0.049	0.048	0.00	-2.14%	0.35%	
30	9	0.050	0.049	0.00	-1.16%	0.19%	
30	10	0.050	0.049	0.00	-1.59%	0.26%	
31	11	0.050	0.050	0.00	0.36%	0.06%	
31	12	0.049	0.049	0.00	-0.06%	0.01%	
31	13	0.050	0.049	0.00	-1.51%	0.25%	
31	14	0.049	0.049	0.00	-1.26%	0.21%	
31	15	0.050	0.050	0.00	-0.02%	0.00%	
31	16	0.050	0.049	0.00	-1.03%	0.17%	
Max		0.050	0.050	0.00	0.36%	0.35%	
Average		0.049	0.049	0.00	-0.74%	0.14%	
Min		0.049	0.048	0.00	-2.14%	0.00%	
Std Dev		0.000	0.000	0.00	0.76%	0.11%	

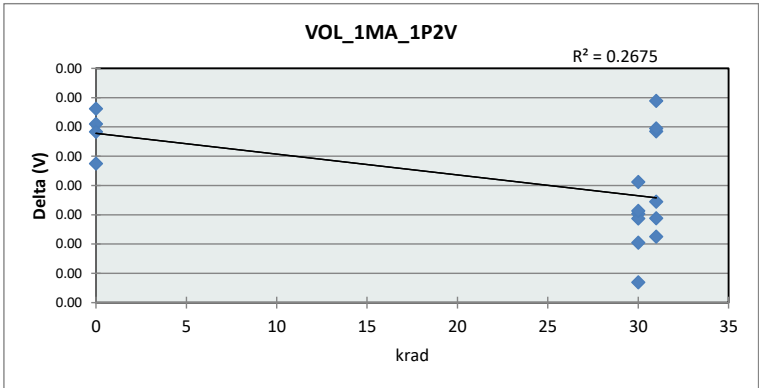

		VOL_1MA_1P2V		
Test Site		CLAB		
Tester		ETS88-01		
Test Number		EQ774601		
Units		V		
Max Limit		0.2		
Min Limit		-0.1		
krad		0	30	31
LL		-0.10	-0.10	-0.10
Min		0.05	0.05	0.05
Average		0.05	0.05	0.05
Max		0.05	0.05	0.05
UL		0.20	0.20	0.20

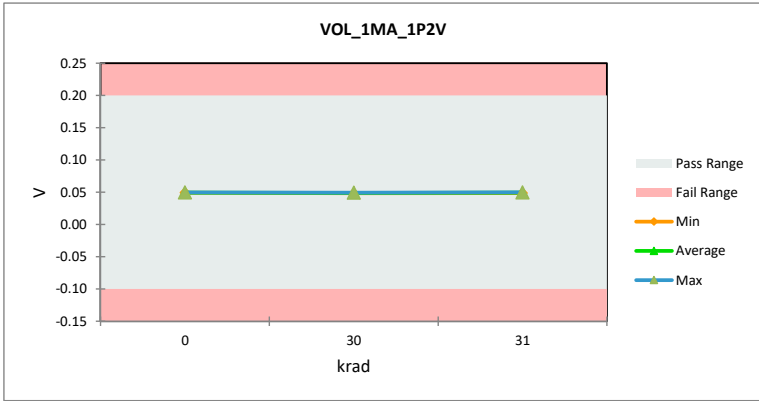

TID Report

SN54SC3T98-SEP

VOL_2MA_1P65V	
Test Site	CLAB
Tester	ETS88-01
Test Number	EQ774601
Units	V
Max Limit	0.2
Min Limit	-0.1

krad	Serial #	PreTestHDR	PostTestHDR	Delta	Delta %	% of Limit Range
0	1	0.061	0.060	0.00	-0.21%	0.04%
0	2	0.061	0.060	0.00	-0.65%	0.13%
0	3	0.061	0.060	0.00	-0.37%	0.07%
0	4	0.061	0.060	0.00	-0.48%	0.10%
30	5	0.061	0.061	0.00	0.85%	0.17%
30	6	0.060	0.061	0.00	0.21%	0.04%
30	7	0.061	0.061	0.00	-0.36%	0.07%
30	8	0.060	0.060	0.00	-0.57%	0.11%
30	9	0.061	0.061	0.00	-0.33%	0.07%
30	10	0.061	0.060	0.00	-0.72%	0.15%
31	11	0.061	0.062	0.00	2.43%	0.49%
31	12	0.060	0.061	0.00	0.30%	0.06%
31	13	0.061	0.061	0.00	0.10%	0.02%
31	14	0.060	0.061	0.00	0.31%	0.06%
31	15	0.061	0.061	0.00	0.47%	0.10%
31	16	0.061	0.061	0.00	0.31%	0.06%
Max		0.061	0.062	0.00	2.43%	0.49%
Average		0.061	0.061	0.00	0.08%	0.11%
Min		0.060	0.060	0.00	-0.72%	0.02%
Std Dev		0.000	0.001	0.00	0.77%	0.11%

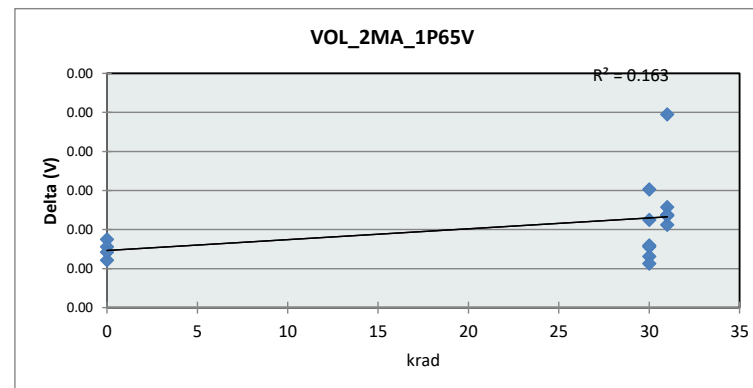

VOL_2MA_1P65V			
Test Site	CLAB		
Tester	ETS88-01		
Test Number	EQ774601		
Units	V		
Max Limit	0.2		
Min Limit	-0.1		
	0	30	31
LL	-0.10	-0.10	-0.10
Min	0.06	0.06	0.06
Average	0.06	0.06	0.06
Max	0.06	0.06	0.06
UL	0.20	0.20	0.20

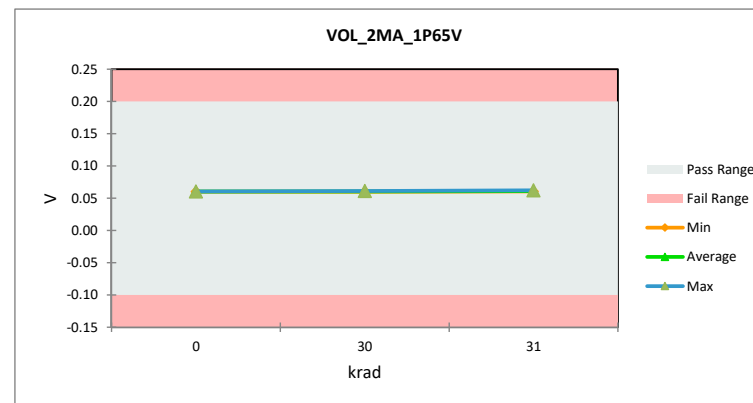

TID Report

SN54SC3T98-SEP

VOL_3MA_2P25V	
Test Site	CLAB
Tester	ETS88-01
Test Number	EQ774601
Units	V
Max Limit	0.2
Min Limit	-0.1

krad	Serial #	PreTestHDR	PostTestHDR	Delta	Delta %	% of Limit Range
0	1	0.069	0.070	0.00	0.51%	0.12%
0	2	0.070	0.069	0.00	-0.39%	0.09%
0	3	0.070	0.070	0.00	-0.28%	0.06%
0	4	0.070	0.070	0.00	-0.39%	0.09%
30	5	0.070	0.071	0.00	1.72%	0.40%
30	6	0.070	0.070	0.00	0.02%	0.00%
30	7	0.070	0.070	0.00	-0.04%	0.01%
30	8	0.070	0.069	0.00	-0.78%	0.18%
30	9	0.070	0.070	0.00	0.65%	0.15%
30	10	0.070	0.070	0.00	-0.06%	0.01%
31	11	0.070	0.072	0.00	2.82%	0.66%
31	12	0.070	0.070	0.00	0.33%	0.08%
31	13	0.070	0.070	0.00	0.36%	0.08%
31	14	0.070	0.070	0.00	-0.07%	0.02%
31	15	0.070	0.071	0.00	1.13%	0.26%
31	16	0.070	0.070	0.00	0.53%	0.12%
Max		0.070	0.072	0.00	2.82%	0.66%
Average		0.070	0.070	0.00	0.38%	0.15%
Min		0.069	0.069	0.00	-0.78%	0.00%
Std Dev		0.000	0.001	0.00	0.90%	0.17%

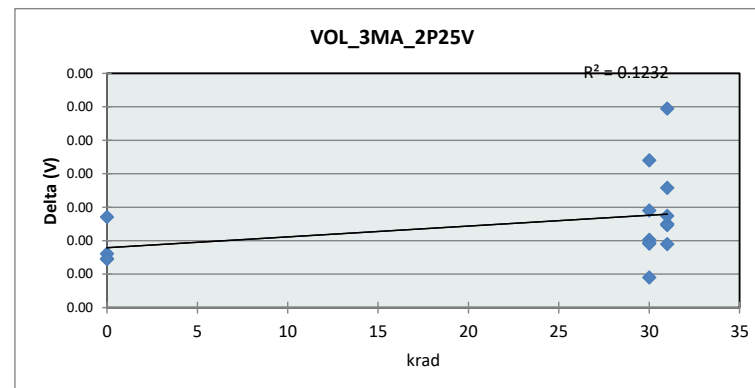

VOL_3MA_2P25V			
Test Site	CLAB		
Tester	ETS88-01		
Test Number	EQ774601		
Units	V		
Max Limit	0.2		
Min Limit	-0.1		
krad	0	30	31
LL	-0.10	-0.10	-0.10
Min	0.07	0.07	0.07
Average	0.07	0.07	0.07
Max	0.07	0.07	0.07
UL	0.20	0.20	0.20

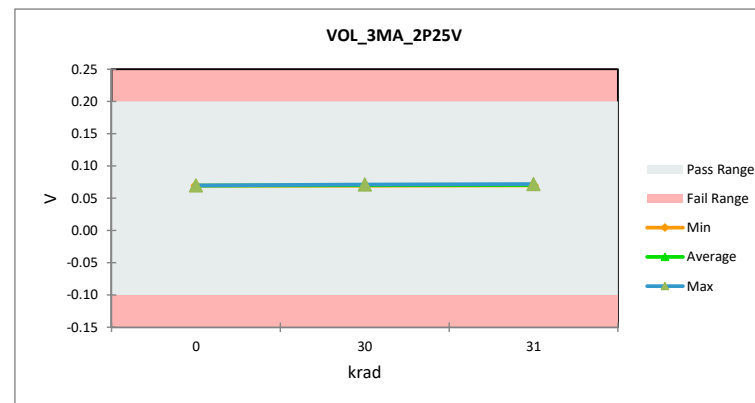

TID Report

SN54SC3T98-SEP

VOL_5P5MA_3V	
Test Site	CLAB
Tester	ETS88-01
Test Number	EQ774601
Units	V
Max Limit	0.25
Min Limit	-0.1

krad	Serial #	PreTestHDR	PostTestHDR	Delta	Delta %	% of Limit Range
0	1	0.109	0.109	0.00	-0.07%	0.02%
0	2	0.109	0.109	0.00	-0.27%	0.09%
0	3	0.109	0.109	0.00	-0.27%	0.09%
0	4	0.110	0.109	0.00	-0.50%	0.16%
30	5	0.109	0.112	0.00	2.38%	0.74%
30	6	0.110	0.110	0.00	0.21%	0.07%
30	7	0.110	0.110	0.00	0.18%	0.06%
30	8	0.110	0.109	0.00	-0.93%	0.29%
30	9	0.110	0.110	0.00	0.58%	0.18%
30	10	0.110	0.110	0.00	-0.13%	0.04%
31	11	0.109	0.114	0.00	3.89%	1.22%
31	12	0.110	0.110	0.00	0.30%	0.09%
31	13	0.110	0.110	0.00	0.33%	0.10%
31	14	0.110	0.109	0.00	-0.19%	0.06%
31	15	0.110	0.111	0.00	1.09%	0.34%
31	16	0.110	0.111	0.00	0.72%	0.23%
Max		0.110	0.114	0.00	3.89%	1.22%
Average		0.110	0.110	0.00	0.46%	0.24%
Min		0.109	0.109	0.00	-0.93%	0.02%
Std Dev		0.000	0.001	0.00	1.19%	0.32%

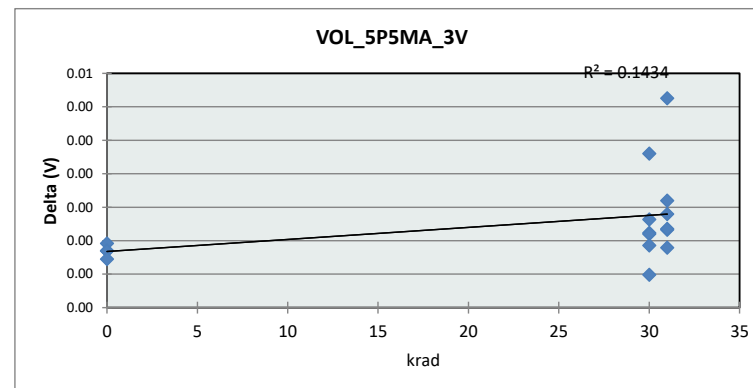

VOL_5P5MA_3V			
Test Site	CLAB		
Tester	ETS88-01		
Test Number	EQ774601		
Units	V		
Max Limit	0.25		
Min Limit	-0.1		
	0	30	31
LL	-0.10	-0.10	-0.10
Min	0.11	0.11	0.11
Average	0.11	0.11	0.11
Max	0.11	0.11	0.11
UL	0.25	0.25	0.25

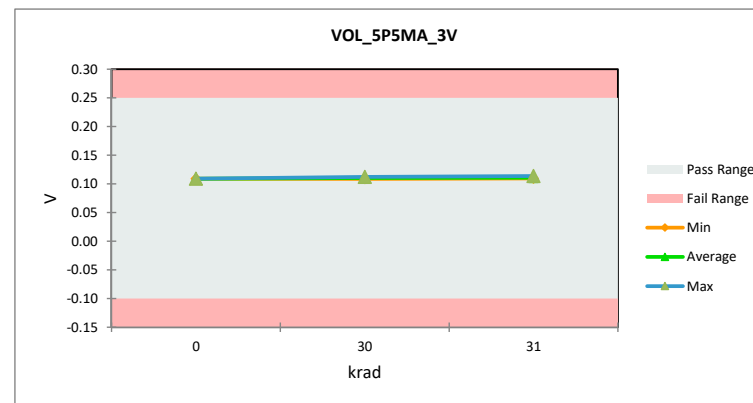

TID Report

SN54SC3T98-SEP

VOL_8MA_4P5V	
Test Site	CLAB
Tester	ETS88-01
Test Number	EQ774601
Units	V
Max Limit	0.35
Min Limit	-0.1

krad	Serial #	PreTestHDR	PostTestHDR	Delta	Delta %	% of Limit Range
0	1	0.138	0.138	0.00	0.28%	0.09%
0	2	0.138	0.138	0.00	-0.04%	0.01%
0	3	0.138	0.138	0.00	-0.15%	0.05%
0	4	0.138	0.138	0.00	-0.35%	0.11%
30	5	0.138	0.142	0.00	2.79%	0.86%
30	6	0.138	0.139	0.00	0.62%	0.19%
30	7	0.138	0.139	0.00	0.42%	0.13%
30	8	0.139	0.138	0.00	-0.82%	0.25%
30	9	0.138	0.140	0.00	1.01%	0.31%
30	10	0.139	0.139	0.00	0.19%	0.06%
31	11	0.138	0.144	0.01	4.39%	1.35%
31	12	0.138	0.140	0.00	0.87%	0.27%
31	13	0.138	0.139	0.00	0.75%	0.23%
31	14	0.139	0.139	0.00	-0.06%	0.02%
31	15	0.138	0.141	0.00	1.50%	0.46%
31	16	0.139	0.140	0.00	0.89%	0.27%
Max		0.139	0.144	0.01	4.39%	1.35%
Average		0.138	0.139	0.00	0.77%	0.29%
Min		0.138	0.138	0.00	-0.82%	0.01%
Std Dev		0.000	0.002	0.00	1.28%	0.35%

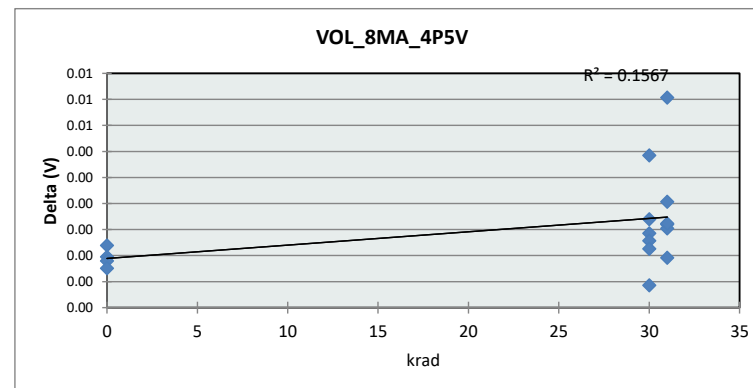

VOL_8MA_4P5V			
Test Site	CLAB		
Tester	ETS88-01		
Test Number	EQ774601		
Units	V		
Max Limit	0.35		
Min Limit	-0.1		
krad	0	30	31
LL	-0.10	-0.10	-0.10
Min	0.14	0.14	0.14
Average	0.14	0.14	0.14
Max	0.14	0.14	0.14
UL	0.35	0.35	0.35

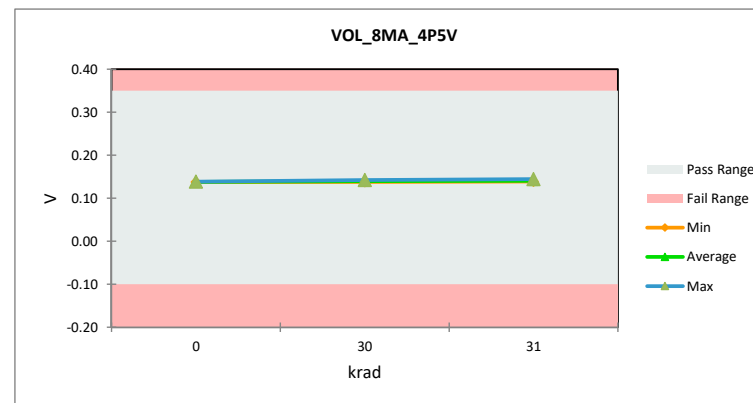

TID Report

SN54SC3T98-SEP

VOL_24MA_4P5V	
Test Site	CLAB
Tester	ETS88-01
Test Number	EQ774601
Units	V
Max Limit	0.75
Min Limit	-0.1

krad	Serial #	PreTestHDR	PostTestHDR	Delta	Delta %	% of Limit Range
0	1	0.417	0.418	0.00	0.19%	0.09%
0	2	0.417	0.417	0.00	-0.06%	0.03%
0	3	0.417	0.417	0.00	-0.07%	0.04%
0	4	0.419	0.417	0.00	-0.37%	0.18%
30	5	0.418	0.430	0.01	2.91%	1.43%
30	6	0.419	0.421	0.00	0.56%	0.28%
30	7	0.419	0.420	0.00	0.27%	0.13%
30	8	0.420	0.416	0.00	-0.84%	0.42%
30	9	0.419	0.423	0.00	1.10%	0.54%
30	10	0.419	0.420	0.00	0.41%	0.20%
31	11	0.418	0.437	0.02	4.53%	2.23%
31	12	0.419	0.421	0.00	0.64%	0.32%
31	13	0.419	0.421	0.00	0.52%	0.26%
31	14	0.420	0.419	0.00	-0.12%	0.06%
31	15	0.419	0.425	0.01	1.60%	0.79%
31	16	0.419	0.422	0.00	0.89%	0.44%
Max		0.420	0.437	0.02	4.53%	2.23%
Average		0.419	0.422	0.00	0.76%	0.46%
Min		0.417	0.416	0.00	-0.84%	0.03%
Std Dev		0.001	0.005	0.00	1.33%	0.59%

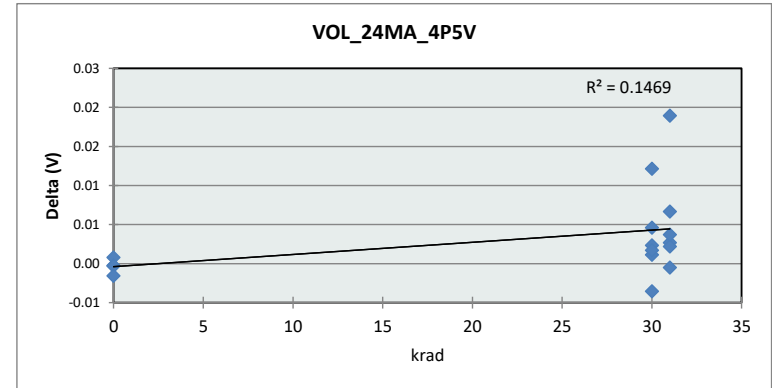

VOL_24MA_4P5V			
Test Site	CLAB		
Tester	ETS88-01		
Test Number	EQ774601		
Units	V		
Max Limit	0.75		
Min Limit	-0.1		
krad	0	30	31
LL	-0.10	-0.10	-0.10
Min	0.42	0.42	0.42
Average	0.42	0.42	0.42
Max	0.42	0.43	0.44
UL	0.75	0.75	0.75

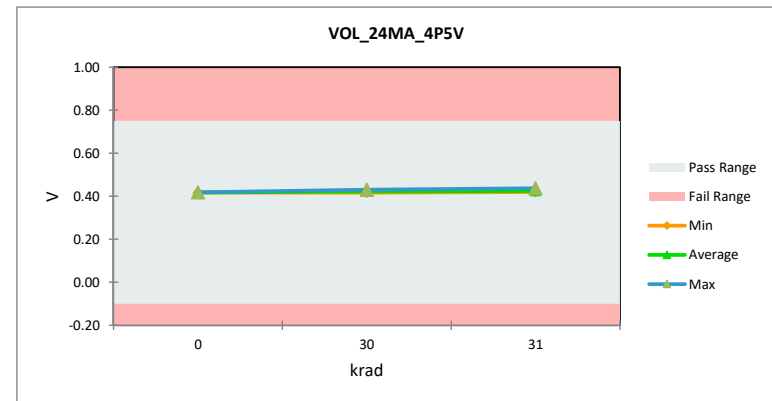

TID Report

SN54SC3T98-SEP

VOL_24MA_5P5V	
Test Site	CLAB
Tester	ETS88-01
Test Number	EQ774601
Units	V
Max Limit	0.75
Min Limit	-0.1

krad	Serial #	PreTestHDR	PostTestHDR	Delta	Delta %	% of Limit Range
0	1	0.399	0.400	0.00	0.19%	0.09%
0	2	0.399	0.399	0.00	0.01%	0.00%
0	3	0.399	0.399	0.00	-0.01%	0.00%
0	4	0.400	0.399	0.00	-0.28%	0.13%
30	5	0.400	0.412	0.01	3.04%	1.43%
30	6	0.400	0.403	0.00	0.68%	0.32%
30	7	0.400	0.402	0.00	0.37%	0.17%
30	8	0.401	0.398	0.00	-0.79%	0.37%
30	9	0.400	0.405	0.00	1.16%	0.54%
30	10	0.400	0.402	0.00	0.45%	0.21%
31	11	0.400	0.418	0.02	4.60%	2.16%
31	12	0.400	0.403	0.00	0.78%	0.37%
31	13	0.400	0.402	0.00	0.55%	0.26%
31	14	0.401	0.401	0.00	-0.10%	0.05%
31	15	0.400	0.407	0.01	1.65%	0.78%
31	16	0.400	0.404	0.00	0.96%	0.45%
Max		0.401	0.418	0.02	4.60%	2.16%
Average		0.400	0.403	0.00	0.83%	0.46%
Min		0.399	0.398	0.00	-0.79%	0.00%
Std Dev		0.001	0.005	0.00	1.34%	0.58%

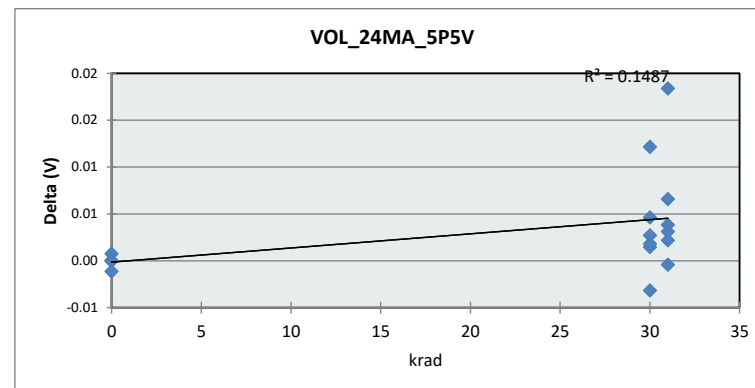

VOL_24MA_5P5V			
Test Site	CLAB		
Tester	ETS88-01		
Test Number	EQ774601		
Units	V		
Max Limit	0.75		
Min Limit	-0.1		
	0	30	31
LL	-0.10	-0.10	-0.10
Min	0.40	0.40	0.40
Average	0.40	0.40	0.41
Max	0.40	0.41	0.42
UL	0.75	0.75	0.75

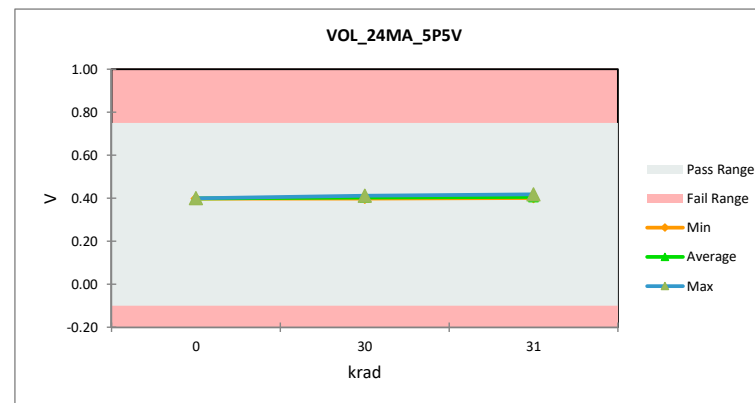

TID Report SN54SC3T98-SEP

VOL_50UA_1P2V	
Test Site	CLAB
Tester	ETS88-01
Test Number	EQ774601
Units	V
Max Limit	0.1
Min Limit	-0.1

krad	Serial #	PreTestHDR	PostTestHDR	Delta	Delta %	% of Limit Range
0	1	0.002	0.002	0.00	9.81%	0.10%
0	2	0.002	0.002	0.00	-6.83%	0.08%
0	3	0.002	0.002	0.00	-3.31%	0.04%
0	4	0.002	0.002	0.00	-2.44%	0.03%
30	5	0.002	0.002	0.00	-10.75%	0.13%
30	6	0.002	0.002	0.00	9.87%	0.11%
30	7	0.002	0.002	0.00	-2.01%	0.02%
30	8	0.002	0.002	0.00	-4.06%	0.05%
30	9	0.002	0.002	0.00	-0.14%	0.00%
30	10	0.002	0.002	0.00	5.54%	0.06%
31	11	0.002	0.002	0.00	-10.03%	0.12%
31	12	0.002	0.002	0.00	8.41%	0.09%
31	13	0.002	0.002	0.00	-5.75%	0.07%
31	14	0.002	0.002	0.00	-5.06%	0.06%
31	15	0.002	0.002	0.00	2.87%	0.03%
31	16	0.002	0.002	0.00	7.64%	0.08%
Max		0.002	0.002	0.00	9.87%	0.13%
Average		0.002	0.002	0.00	-0.39%	0.07%
Min		0.002	0.002	0.00	-10.75%	0.00%
Std Dev		0.000	0.000	0.00	6.92%	0.04%

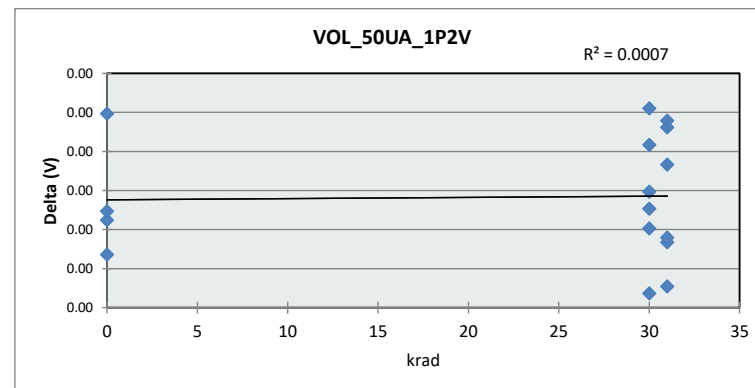

VOL_50UA_1P2V			
Test Site	CLAB		
Tester	ETS88-01		
Test Number	EQ774601		
Units	V		
Max Limit	0.1		
Min Limit	-0.1		
krad	0	30	31
LL	-0.10	-0.10	-0.10
Min	0.00	0.00	0.00
Average	0.00	0.00	0.00
Max	0.00	0.00	0.00
UL	0.10	0.10	0.10

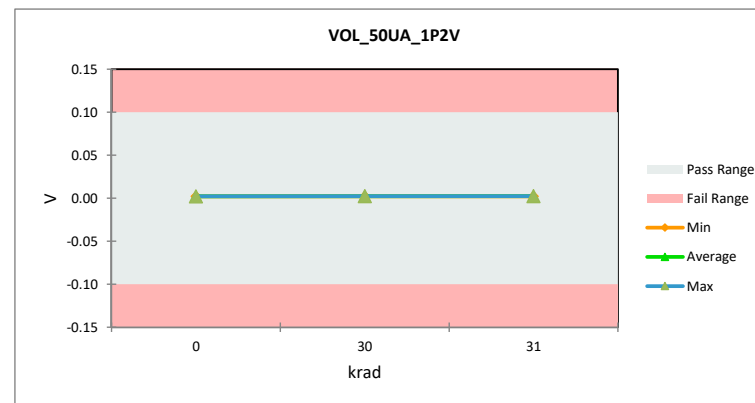

TID Report SN54SC3T98-SEP

VOL_50UA_1P65V	
Test Site	CLAB
Tester	ETS88-01
Test Number	EQ774601
Units	V
Max Limit	0.1
Min Limit	-0.1

krad	Serial #	PreTestHDR	PostTestHDR	Delta	Delta %	% of Limit Range
0	1	0.002	0.001	0.00	-17.35%	0.13%
0	2	0.001	0.001	0.00	1.25%	0.01%
0	3	0.001	0.001	0.00	-1.81%	0.01%
0	4	0.001	0.001	0.00	-0.57%	0.00%
30	5	0.001	0.002	0.00	9.10%	0.06%
30	6	0.001	0.001	0.00	24.95%	0.15%
30	7	0.001	0.001	0.00	2.65%	0.02%
30	8	0.001	0.001	0.00	-4.61%	0.03%
30	9	0.001	0.001	0.00	-6.17%	0.04%
30	10	0.001	0.001	0.00	2.61%	0.02%
31	11	0.001	0.001	0.00	1.25%	0.01%
31	12	0.001	0.001	0.00	22.27%	0.13%
31	13	0.001	0.001	0.00	-3.29%	0.02%
31	14	0.001	0.001	0.00	-0.21%	0.00%
31	15	0.001	0.002	0.00	4.59%	0.03%
31	16	0.001	0.001	0.00	10.51%	0.07%
Max		0.002	0.002	0.00	24.95%	0.15%
Average		0.001	0.001	0.00	2.82%	0.05%
Min		0.001	0.001	0.00	-17.35%	0.00%
Std Dev		0.000	0.000	0.00	10.32%	0.05%

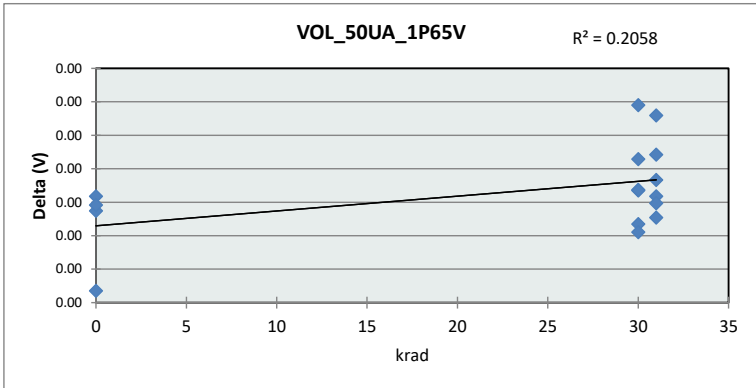

VOL_50UA_1P65V			
Test Site	CLAB		
Tester	ETS88-01		
Test Number	EQ774601		
Units	V		
Max Limit	0.1		
Min Limit	-0.1		
	0	30	31
LL	-0.10	-0.10	-0.10
Min	0.00	0.00	0.00
Average	0.00	0.00	0.00
Max	0.00	0.00	0.00
UL	0.10	0.10	0.10

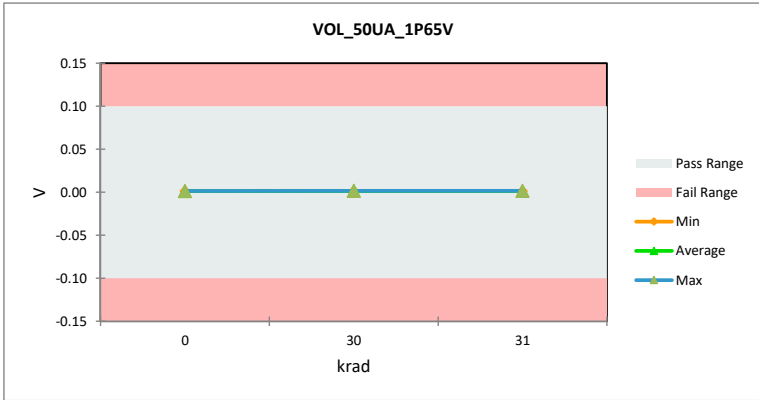

TID Report

SN54SC3T98-SEP

VTN_1P2V	
Test Site	CLAB
Tester	ETS88-01
Test Number	EQ774601
Units	V
Max Limit	0.622
Min Limit	0.11

krad	Serial #	PreTestHDR	PostTestHDR	Delta	Delta %	% of Limit Range
0	1	0.335	0.335	0.00	0.04%	0.02%
0	2	0.331	0.330	0.00	-0.12%	0.08%
0	3	0.333	0.333	0.00	-0.04%	0.03%
0	4	0.333	0.333	0.00	-0.01%	0.01%
30	5	0.332	0.290	-0.04	-12.66%	8.21%
30	6	0.333	0.286	-0.05	-14.22%	9.25%
30	7	0.332	0.293	-0.04	-11.95%	7.76%
30	8	0.334	0.278	-0.06	-17.01%	11.11%
30	9	0.332	0.289	-0.04	-12.91%	8.38%
30	10	0.333	0.288	-0.05	-13.73%	8.94%
31	11	0.332	0.313	-0.02	-5.81%	3.77%
31	12	0.333	0.312	-0.02	-6.41%	4.17%
31	13	0.332	0.316	-0.02	-4.78%	3.10%
31	14	0.334	0.313	-0.02	-6.30%	4.12%
31	15	0.332	0.311	-0.02	-6.50%	4.22%
31	16	0.333	0.312	-0.02	-6.52%	4.25%
Max		0.335	0.335	0.00	0.04%	11.11%
Average		0.333	0.308	-0.02	-7.43%	4.84%
Min		0.331	0.278	-0.05	-17.01%	0.01%
Std Dev		0.001	0.019	0.02	5.70%	3.71%

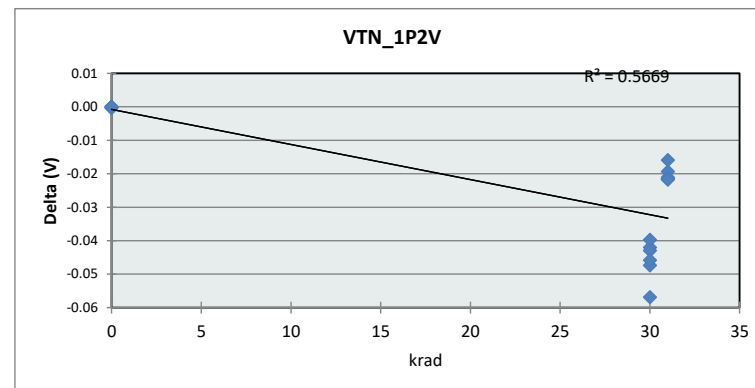

VTN_1P2V		0	30	31
Test Site	CLAB			
Tester	ETS88-01			
Test Number	EQ774601			
Units	V			
Max Limit	0.622			
Min Limit	0.11			
LL		0.11	0.11	0.11
Min		0.33	0.28	0.31
Average		0.33	0.29	0.31
Max		0.34	0.29	0.32
UL		0.62	0.62	0.62

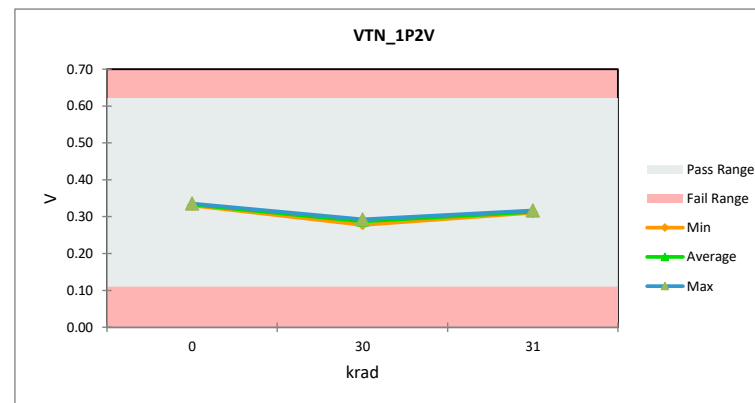

TID Report

SN54SC3T98-SEP

VTN_1P65V	
Test Site	CLAB
Tester	ETS88-01
Test Number	EQ774601
Units	V
Max Limit	0.666
Min Limit	0.18

krad	Serial #	PreTestHDR	PostTestHDR	Delta	Delta %	% of Limit Range
0	1	0.423	0.424	0.00	0.06%	0.05%
0	2	0.418	0.419	0.00	0.15%	0.13%
0	3	0.421	0.421	0.00	0.13%	0.11%
0	4	0.421	0.422	0.00	0.11%	0.10%
30	5	0.420	0.372	-0.05	-11.34%	9.80%
30	6	0.422	0.370	-0.05	-12.18%	10.57%
30	7	0.420	0.376	-0.04	-10.48%	9.06%
30	8	0.421	0.364	-0.06	-13.54%	11.72%
30	9	0.420	0.372	-0.05	-11.47%	9.92%
30	10	0.421	0.369	-0.05	-12.17%	10.54%
31	11	0.420	0.395	-0.02	-5.89%	5.09%
31	12	0.422	0.395	-0.03	-6.40%	5.56%
31	13	0.420	0.398	-0.02	-5.20%	4.50%
31	14	0.421	0.396	-0.02	-5.86%	5.07%
31	15	0.420	0.393	-0.03	-6.56%	5.67%
31	16	0.421	0.393	-0.03	-6.66%	5.77%
Max		0.423	0.424	0.00	0.15%	11.72%
Average		0.421	0.392	-0.03	-6.71%	5.85%
Min		0.418	0.364	-0.05	-13.54%	0.05%
Std Dev		0.001	0.021	0.02	4.86%	4.14%

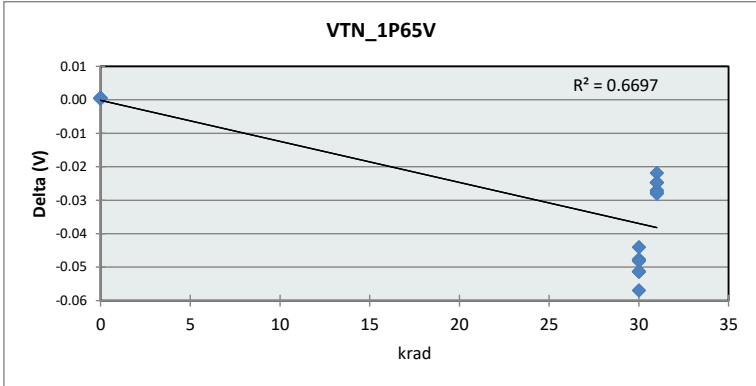

VTN_1P65V		0	30	31
Test Site	CLAB			
Tester	ETS88-01			
Test Number	EQ774601			
Units	V			
Max Limit	0.666			
Min Limit	0.18			
LL		0.18	0.18	0.18
Min		0.42	0.36	0.39
Average		0.42	0.37	0.39
Max		0.42	0.38	0.40
UL		0.67	0.67	0.67

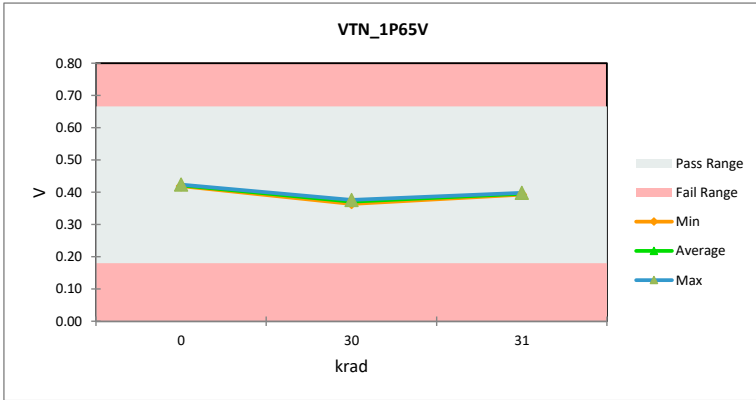

TID Report

SN54SC3T98-SEP

VTN_2P25V	
Test Site	CLAB
Tester	ETS88-01
Test Number	EQ774601
Units	V
Max Limit	0.74
Min Limit	0.25

krad	Serial #	PreTestHDR	PostTestHDR	Delta	Delta %	% of Limit Range
0	1	0.506	0.506	0.00	0.08%	0.08%
0	2	0.501	0.501	0.00	0.06%	0.06%
0	3	0.504	0.505	0.00	0.23%	0.24%
0	4	0.504	0.505	0.00	0.16%	0.17%
30	5	0.502	0.465	-0.04	-7.42%	7.60%
30	6	0.505	0.465	-0.04	-7.87%	8.11%
30	7	0.503	0.469	-0.03	-6.79%	6.97%
30	8	0.503	0.463	-0.04	-7.98%	8.19%
30	9	0.503	0.467	-0.04	-7.18%	7.37%
30	10	0.503	0.465	-0.04	-7.70%	7.91%
31	11	0.502	0.481	-0.02	-4.21%	4.32%
31	12	0.505	0.483	-0.02	-4.29%	4.42%
31	13	0.503	0.485	-0.02	-3.68%	3.78%
31	14	0.503	0.483	-0.02	-3.94%	4.04%
31	15	0.503	0.481	-0.02	-4.38%	4.49%
31	16	0.503	0.481	-0.02	-4.40%	4.52%
Max		0.506	0.506	0.00	0.23%	8.19%
Average		0.503	0.482	-0.02	-4.33%	4.52%
Min		0.501	0.463	-0.04	-7.98%	0.06%
Std Dev		0.001	0.016	0.01	3.07%	3.05%

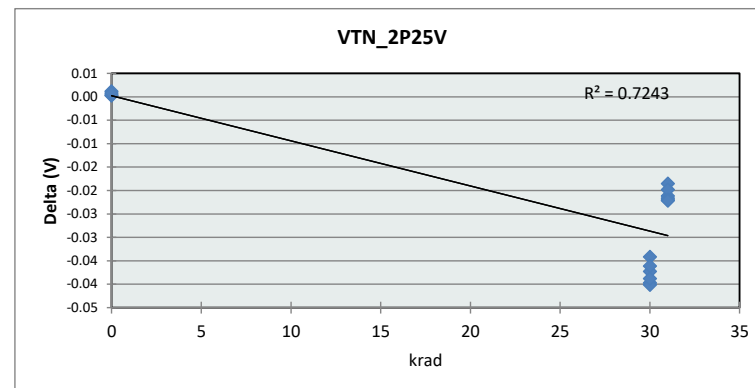

VTN_2P25V		0	30	31
Test Site	CLAB			
Tester	ETS88-01			
Test Number	EQ774601			
Units	V			
Max Limit	0.74			
Min Limit	0.25			
krad		0	30	31
LL		0.25	0.25	0.25
Min		0.50	0.46	0.48
Average		0.50	0.47	0.48
Max		0.51	0.47	0.48
UL		0.74	0.74	0.74

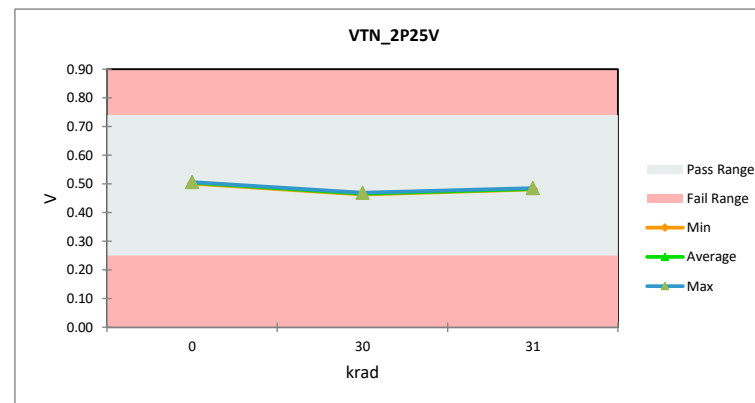

TID Report SN54SC3T98-SEP

VTN_2P75V

Test Site	CLAB
Tester	ETS88-01
Test Number	EQ774601
Units	V
Max Limit	0.74
Min Limit	0.25

krad	Serial #	PreTestHDR	PostTestHDR	Delta	Delta %	% of Limit Range
0	1	0.570	0.570	0.00	0.03%	0.04%
0	2	0.565	0.566	0.00	0.15%	0.17%
0	3	0.568	0.569	0.00	0.20%	0.23%
0	4	0.569	0.569	0.00	0.08%	0.09%
30	5	0.567	0.543	-0.02	-4.27%	4.94%
30	6	0.569	0.544	-0.03	-4.53%	5.26%
30	7	0.568	0.547	-0.02	-3.60%	4.18%
30	8	0.567	0.542	-0.03	-4.41%	5.11%
30	9	0.566	0.546	-0.02	-3.51%	4.06%
30	10	0.567	0.545	-0.02	-3.92%	4.54%
31	11	0.567	0.552	-0.01	-2.64%	3.06%
31	12	0.569	0.555	-0.01	-2.58%	3.00%
31	13	0.568	0.556	-0.01	-1.98%	2.30%
31	14	0.567	0.553	-0.01	-2.52%	2.92%
31	15	0.566	0.553	-0.01	-2.21%	2.55%
31	16	0.567	0.555	-0.01	-2.21%	2.56%
	Max	0.570	0.570	0.00	0.20%	5.26%
	Average	0.568	0.554	-0.01	-2.37%	2.81%
	Min	0.565	0.542	-0.02	-4.53%	0.04%
	Std Dev	0.001	0.010	0.01	1.69%	1.85%

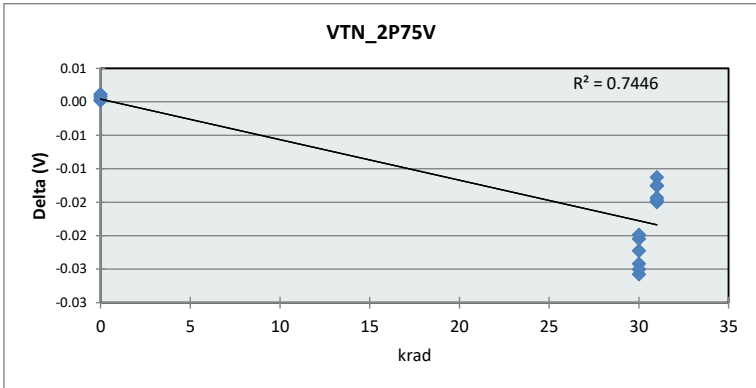

Test Site	CLAB
Tester	ETS88-01
Test Number	EQ774601
Units	V
Max Limit	0.74
Min Limit	0.25

	0	30	31
LL	0.25	0.25	0.25
Min	0.57	0.54	0.55
Average	0.57	0.54	0.55
Max	0.57	0.55	0.56
UL	0.74	0.74	0.74

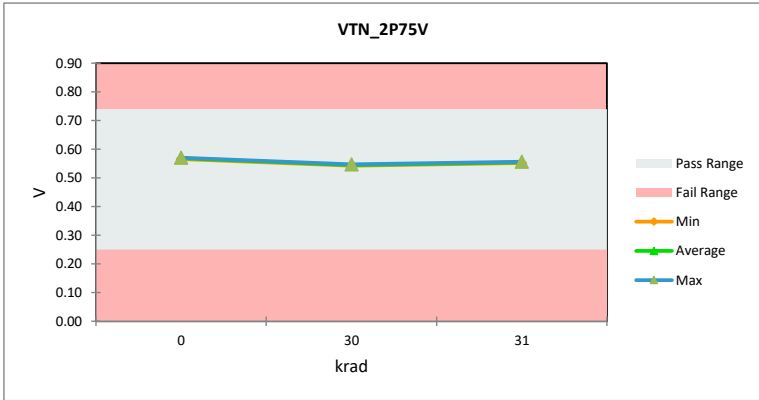

TID Report SN54SC3T98-SEP

VTN_2V	
Test Site	CLAB
Tester	ETS88-01
Test Number	EQ774601
Units	V
Max Limit	0.666
Min Limit	0.18

krad	Serial #	PreTestHDR	PostTestHDR	Delta	Delta %	% of Limit Range
0	1	0.473	0.474	0.00	0.09%	0.09%
0	2	0.468	0.469	0.00	0.17%	0.17%
0	3	0.471	0.472	0.00	0.11%	0.11%
0	4	0.472	0.472	0.00	0.10%	0.10%
30	5	0.471	0.427	-0.04	-9.18%	8.90%
30	6	0.472	0.426	-0.05	-9.73%	9.46%
30	7	0.471	0.431	-0.04	-8.41%	8.15%
30	8	0.471	0.422	-0.05	-10.34%	10.01%
30	9	0.470	0.428	-0.04	-8.88%	8.59%
30	10	0.471	0.426	-0.05	-9.61%	9.31%
31	11	0.471	0.447	-0.02	-5.06%	4.90%
31	12	0.472	0.448	-0.02	-5.13%	4.99%
31	13	0.471	0.451	-0.02	-4.30%	4.16%
31	14	0.471	0.448	-0.02	-4.81%	4.66%
31	15	0.470	0.445	-0.02	-5.31%	5.14%
31	16	0.471	0.445	-0.03	-5.44%	5.27%
Max		0.473	0.474	0.00	0.17%	10.01%
Average		0.471	0.446	-0.03	-5.36%	5.25%
Min		0.468	0.422	-0.05	-10.34%	0.09%
Std Dev		0.001	0.018	0.02	3.83%	3.62%

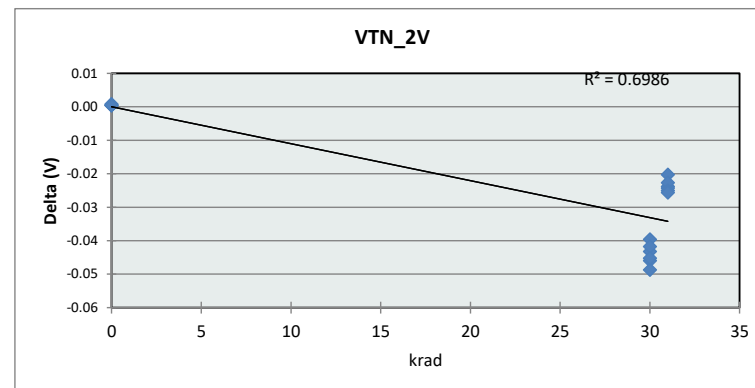

VTN_2V			
Test Site	CLAB		
Tester	ETS88-01		
Test Number	EQ774601		
Units	V		
Max Limit	0.666		
Min Limit	0.18		
krad	0	30	31
LL	0.18	0.18	0.18
Min	0.47	0.42	0.45
Average	0.47	0.43	0.45
Max	0.47	0.43	0.45
UL	0.67	0.67	0.67

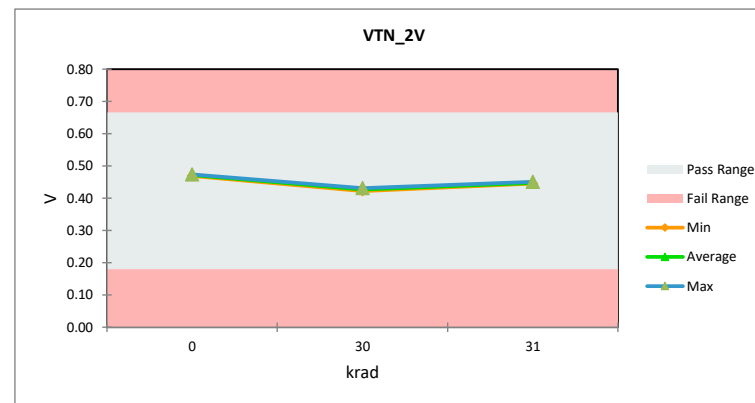

TID Report SN54SC3T98-SEP

VTN_3P6V							
Test Site		CLAB					
Tester		ETS88-01					
Test Number		EQ774601					
Units		V					
Max Limit		0.85					
Min Limit		0.33					
krad	Serial #	PreTestHDR	PostTestHDR	Delta	Delta %	% of Limit Range	
0	1	0.672	0.672	0.00	-0.01%	0.02%	
0	2	0.667	0.668	0.00	0.13%	0.16%	
0	3	0.670	0.671	0.00	0.16%	0.20%	
0	4	0.670	0.671	0.00	0.18%	0.23%	
30	5	0.669	0.660	-0.01	-1.29%	1.66%	
30	6	0.672	0.662	-0.01	-1.38%	1.79%	
30	7	0.670	0.662	-0.01	-1.16%	1.49%	
30	8	0.669	0.661	-0.01	-1.24%	1.60%	
30	9	0.668	0.662	-0.01	-0.94%	1.20%	
30	10	0.669	0.663	-0.01	-0.81%	1.04%	
31	11	0.669	0.663	-0.01	-0.82%	1.06%	
31	12	0.672	0.664	-0.01	-1.14%	1.47%	
31	13	0.670	0.662	-0.01	-1.19%	1.53%	
31	14	0.669	0.663	-0.01	-0.87%	1.12%	
31	15	0.668	0.662	-0.01	-0.94%	1.21%	
31	16	0.669	0.663	-0.01	-0.82%	1.05%	
Max		0.672	0.672	0.00	0.18%	1.79%	
Average		0.670	0.664	-0.01	-0.76%	1.05%	
Min		0.667	0.660	-0.01	-1.38%	0.02%	
Std Dev		0.001	0.004	0.00	0.55%	0.58%	

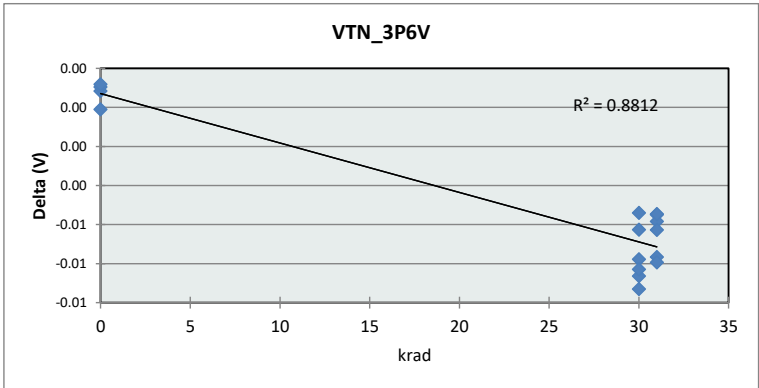

VTN_3P6V			
Test Site		CLAB	
Tester		ETS88-01	
Test Number		EQ774601	
Units		V	
Max Limit		0.85	
Min Limit		0.33	
krad	0	30	31
LL	0.33	0.33	0.33
Min	0.67	0.66	0.66
Average	0.67	0.66	0.66
Max	0.67	0.66	0.66
UL	0.85	0.85	0.85

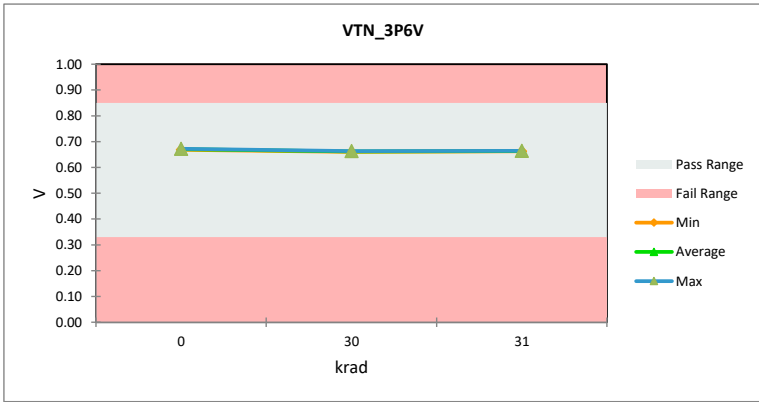

TID Report SN54SC3T98-SEP

VTN_3V							
Test Site	CLAB						
Tester	ETS88-01						
Test Number	EQ774601						
Units	V						
Max Limit	0.85						
Min Limit	0.33						
krad	Serial #	PreTestHDR	PostTestHDR	Delta	Delta %	% of Limit Range	
0	1	0.601	0.602	0.00	0.08%	0.09%	
0	2	0.596	0.596	0.00	0.04%	0.05%	
0	3	0.599	0.599	0.00	0.14%	0.16%	
0	4	0.599	0.600	0.00	0.07%	0.08%	
30	5	0.597	0.580	-0.02	-2.83%	3.24%	
30	6	0.600	0.582	-0.02	-3.10%	3.58%	
30	7	0.599	0.584	-0.02	-2.52%	2.91%	
30	8	0.597	0.580	-0.02	-2.98%	3.42%	
30	9	0.597	0.583	-0.01	-2.28%	2.61%	
30	10	0.598	0.583	-0.01	-2.46%	2.83%	
31	11	0.597	0.586	-0.01	-1.87%	2.15%	
31	12	0.600	0.589	-0.01	-1.95%	2.25%	
31	13	0.599	0.589	-0.01	-1.65%	1.90%	
31	14	0.597	0.587	-0.01	-1.72%	1.98%	
31	15	0.597	0.588	-0.01	-1.42%	1.63%	
31	16	0.598	0.590	-0.01	-1.35%	1.55%	
Max	0.601	0.602	0.00	0.14%	3.58%		
Average	0.598	0.589	-0.01	-1.61%	1.90%		
Min	0.596	0.580	-0.02	-3.10%	0.05%		
Std Dev	0.002	0.007	0.01	1.13%	1.23%		

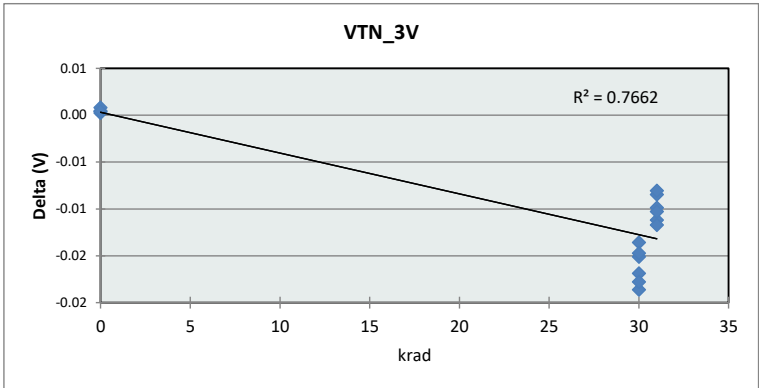

VTN_3V			
Test Site	CLAB		
Tester	ETS88-01		
Test Number	EQ774601		
Units	V		
Max Limit	0.85		
Min Limit	0.33		
krad	0	30	31
LL	0.33	0.33	0.33
Min	0.60	0.58	0.59
Average	0.60	0.58	0.59
Max	0.60	0.58	0.59
UL	0.85	0.85	0.85

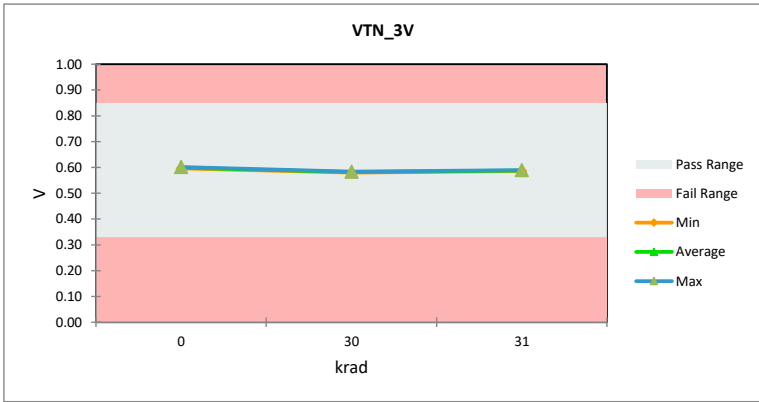

TID Report SN54SC3T98-SEP

VTN_4P5V	
Test Site	CLAB
Tester	ETS88-01
Test Number	EQ774601
Units	V
Max Limit	1.14
Min Limit	0.45

krad	Serial #	PreTestHDR	PostTestHDR	Delta	Delta %	% of Limit Range
0	1	0.774	0.774	0.00	-0.05%	0.05%
0	2	0.770	0.770	0.00	0.02%	0.03%
0	3	0.771	0.771	0.00	0.01%	0.01%
0	4	0.770	0.770	0.00	0.05%	0.05%
30	5	0.770	0.764	-0.01	-0.69%	0.77%
30	6	0.772	0.767	-0.01	-0.67%	0.75%
30	7	0.770	0.765	-0.01	-0.69%	0.77%
30	8	0.770	0.766	0.00	-0.44%	0.49%
30	9	0.770	0.764	-0.01	-0.66%	0.74%
30	10	0.770	0.765	-0.01	-0.70%	0.78%
31	11	0.770	0.765	-0.01	-0.68%	0.76%
31	12	0.772	0.766	-0.01	-0.72%	0.81%
31	13	0.770	0.765	-0.01	-0.69%	0.77%
31	14	0.770	0.765	0.00	-0.53%	0.59%
31	15	0.770	0.764	-0.01	-0.71%	0.79%
31	16	0.770	0.765	-0.01	-0.73%	0.81%
Max		0.774	0.774	0.00	0.05%	0.81%
Average		0.770	0.767	0.00	-0.49%	0.56%
Min		0.770	0.764	-0.01	-0.73%	0.01%
Std Dev		0.001	0.003	0.00	0.31%	0.32%

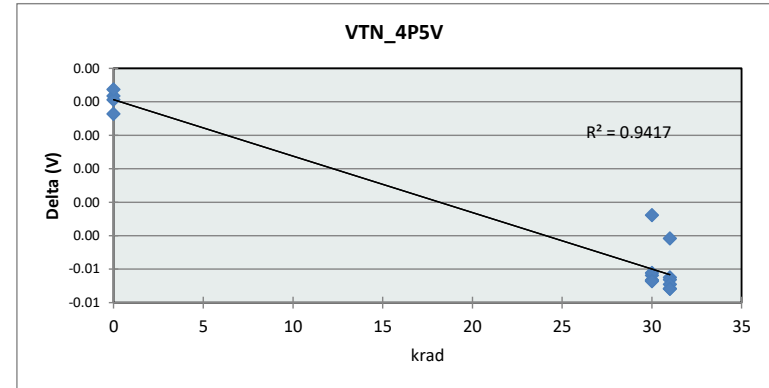

VTN_4P5V			
Test Site	CLAB		
Tester	ETS88-01		
Test Number	EQ774601		
Units	V		
Max Limit	1.14		
Min Limit	0.45		
krad	0	30	31
LL	0.45	0.45	0.45
Min	0.77	0.76	0.76
Average	0.77	0.77	0.76
Max	0.77	0.77	0.77
UL	1.14	1.14	1.14

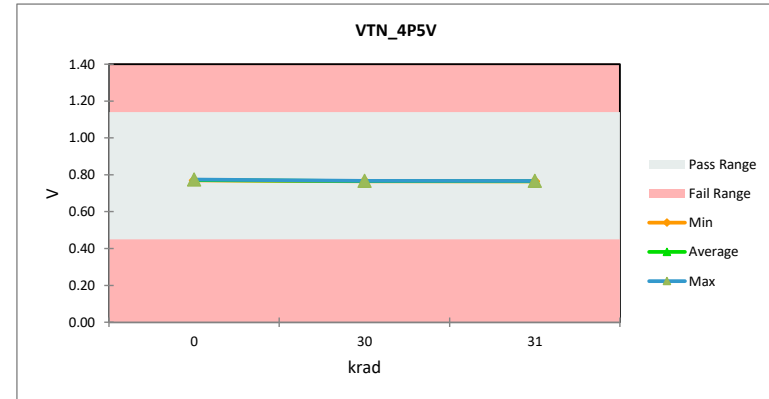

TID Report SN54SC3T98-SEP

VTN_5P5V	
Test Site	CLAB
Tester	ETS88-01
Test Number	EQ774601
Units	V
Max Limit	1.14
Min Limit	0.45

krad	Serial #	PreTestHDR	PostTestHDR	Delta	Delta %	% of Limit Range
0	1	0.878	0.877	0.00	-0.10%	0.13%
0	2	0.872	0.872	0.00	0.03%	0.04%
0	3	0.874	0.874	0.00	-0.03%	0.04%
0	4	0.874	0.874	0.00	0.03%	0.03%
30	5	0.873	0.867	-0.01	-0.70%	0.88%
30	6	0.875	0.870	-0.01	-0.58%	0.73%
30	7	0.875	0.868	-0.01	-0.80%	1.02%
30	8	0.873	0.869	0.00	-0.51%	0.64%
30	9	0.872	0.867	-0.01	-0.62%	0.78%
30	10	0.872	0.867	-0.01	-0.63%	0.80%
31	11	0.873	0.867	-0.01	-0.64%	0.82%
31	12	0.875	0.869	-0.01	-0.64%	0.81%
31	13	0.875	0.871	0.00	-0.50%	0.64%
31	14	0.873	0.868	-0.01	-0.58%	0.73%
31	15	0.872	0.868	0.00	-0.53%	0.67%
31	16	0.872	0.867	-0.01	-0.63%	0.79%
Max		0.878	0.877	0.00	0.03%	1.02%
Average		0.874	0.870	0.00	-0.46%	0.60%
Min		0.872	0.867	-0.01	-0.80%	0.03%
Std Dev		0.002	0.003	0.00	0.28%	0.33%

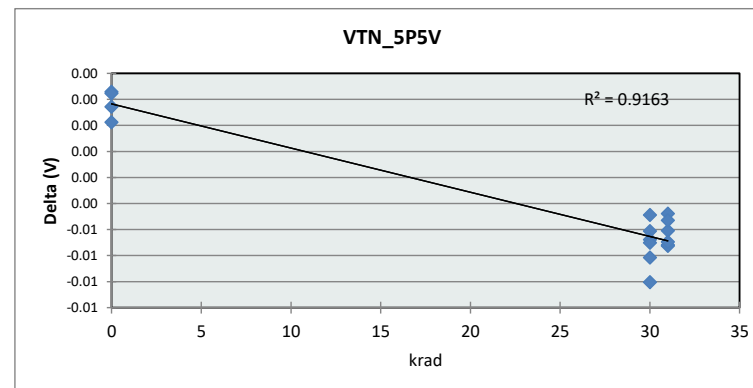

VTN_5P5V		0	30	31
Test Site	CLAB			
Tester	ETS88-01			
Test Number	EQ774601			
Units	V			
Max Limit	1.14			
Min Limit	0.45			
LL		0.45	0.45	0.45
Min		0.87	0.87	0.87
Average		0.87	0.87	0.87
Max		0.88	0.87	0.87
UL		1.14	1.14	1.14

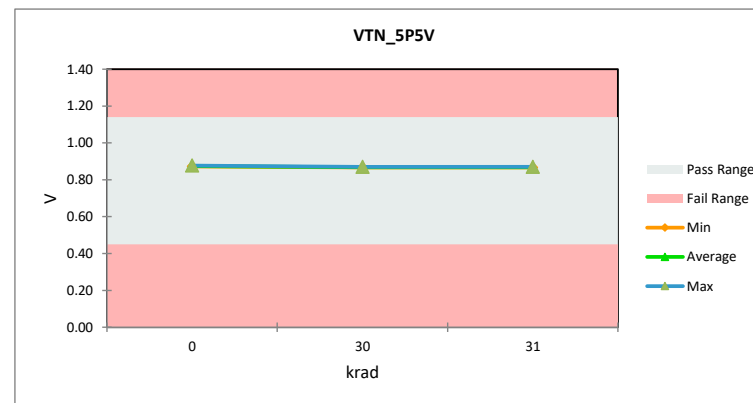

TID Report SN54SC3T98-SEP

VTP_1P2V	
Test Site	CLAB
Tester	ETS88-01
Test Number	EQ774601
Units	V
Max Limit	1.1
Min Limit	0.31

krad	Serial #	PreTestHDR	PostTestHDR	Delta	Delta %	% of Limit Range
0	1	0.699	0.699	0.00	0.02%	0.02%
0	2	0.697	0.699	0.00	0.22%	0.20%
0	3	0.698	0.699	0.00	0.23%	0.20%
0	4	0.698	0.699	0.00	0.16%	0.14%
30	5	0.694	0.620	-0.07	-10.71%	9.42%
30	6	0.697	0.628	-0.07	-9.89%	8.72%
30	7	0.696	0.631	-0.06	-9.30%	8.19%
30	8	0.697	0.629	-0.07	-9.71%	8.56%
30	9	0.698	0.641	-0.06	-8.11%	7.16%
30	10	0.696	0.628	-0.07	-9.84%	8.67%
31	11	0.694	0.665	-0.03	-4.19%	3.68%
31	12	0.697	0.663	-0.03	-4.79%	4.22%
31	13	0.696	0.659	-0.04	-5.20%	4.58%
31	14	0.697	0.669	-0.03	-3.98%	3.51%
31	15	0.698	0.664	-0.03	-4.84%	4.28%
31	16	0.696	0.666	-0.03	-4.40%	3.88%
Max		0.699	0.699	0.00	0.23%	9.42%
Average		0.697	0.660	-0.04	-5.27%	4.71%
Min		0.694	0.620	-0.07	-10.71%	0.02%
Std Dev		0.001	0.028	0.03	3.98%	3.41%

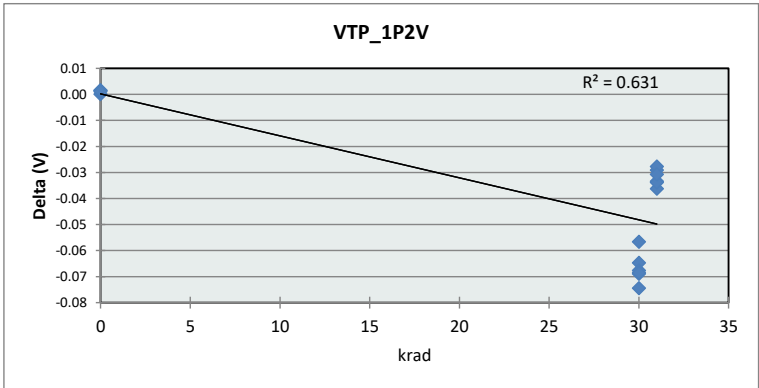

VTP_1P2V		0	30	31
Test Site	CLAB			
Tester	ETS88-01			
Test Number	EQ774601			
Units	V			
Max Limit	1.1			
Min Limit	0.31			
LL		0.31	0.31	0.31
Min		0.70	0.62	0.66
Average		0.70	0.63	0.66
Max		0.70	0.64	0.67
UL		1.10	1.10	1.10

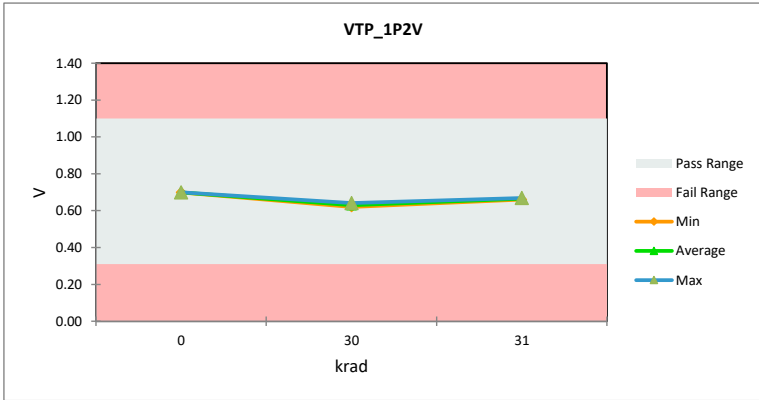

TID Report SN54SC3T98-SEP

VTP_1P65V	
Test Site	CLAB
Tester	ETS88-01
Test Number	EQ774601
Units	V
Max Limit	1.32
Min Limit	0.39

krad	Serial #	PreTestHDR	PostTestHDR	Delta	Delta %	% of Limit Range
0	1	0.860	0.861	0.00	0.11%	0.10%
0	2	0.859	0.861	0.00	0.23%	0.22%
0	3	0.861	0.862	0.00	0.11%	0.11%
0	4	0.859	0.861	0.00	0.17%	0.16%
30	5	0.857	0.839	-0.02	-2.09%	1.93%
30	6	0.859	0.841	-0.02	-2.12%	1.95%
30	7	0.858	0.842	-0.02	-1.78%	1.64%
30	8	0.858	0.841	-0.02	-1.96%	1.80%
30	9	0.858	0.842	-0.02	-1.89%	1.74%
30	10	0.858	0.842	-0.02	-1.81%	1.67%
31	11	0.857	0.850	-0.01	-0.89%	0.82%
31	12	0.859	0.850	-0.01	-1.01%	0.94%
31	13	0.858	0.851	-0.01	-0.72%	0.66%
31	14	0.858	0.848	-0.01	-1.18%	1.09%
31	15	0.858	0.846	-0.01	-1.44%	1.33%
31	16	0.858	0.851	-0.01	-0.81%	0.74%
Max		0.861	0.862	0.00	0.23%	1.95%
Average		0.858	0.849	-0.01	-1.07%	1.06%
Min		0.857	0.839	-0.02	-2.12%	0.10%
Std Dev		0.001	0.008	0.01	0.86%	0.68%

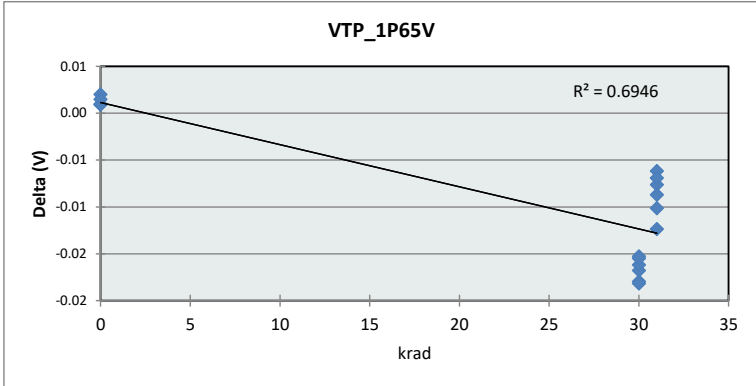

VTP_1P65V		0	30	31
Test Site	CLAB			
Tester	ETS88-01			
Test Number	EQ774601			
Units	V			
Max Limit	1.32			
Min Limit	0.39			
LL		0.39	0.39	0.39
Min		0.86	0.84	0.85
Average		0.86	0.84	0.85
Max		0.86	0.84	0.85
UL		1.32	1.32	1.32

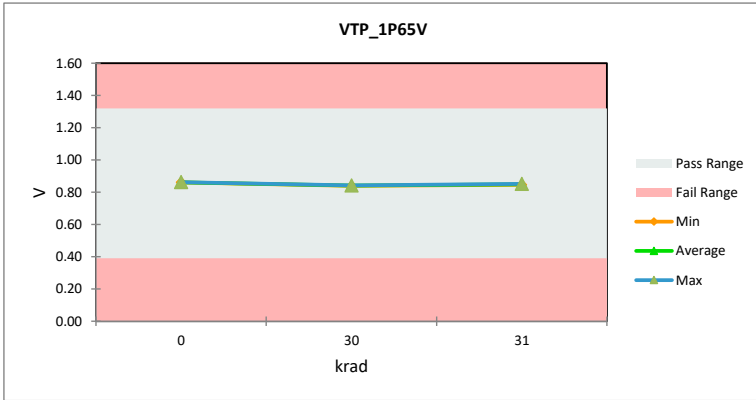

TID Report SN54SC3T98-SEP

VTP_2P25V	
Test Site	CLAB
Tester	ETS88-01
Test Number	EQ774601
Units	V
Max Limit	1.51
Min Limit	0.51

krad	Serial #	PreTestHDR	PostTestHDR	Delta	Delta %	% of Limit Range
0	1	1.013	1.011	0.00	-0.19%	0.19%
0	2	1.011	1.013	0.00	0.23%	0.23%
0	3	1.011	1.014	0.00	0.30%	0.31%
0	4	1.012	1.014	0.00	0.12%	0.12%
30	5	1.009	1.005	0.00	-0.44%	0.44%
30	6	1.011	1.007	0.00	-0.38%	0.39%
30	7	1.008	1.006	0.00	-0.22%	0.22%
30	8	1.008	1.006	0.00	-0.17%	0.17%
30	9	1.009	1.001	-0.01	-0.74%	0.74%
30	10	1.008	1.005	0.00	-0.31%	0.31%
31	11	1.009	1.007	0.00	-0.27%	0.28%
31	12	1.011	1.007	0.00	-0.39%	0.40%
31	13	1.008	1.007	0.00	-0.14%	0.14%
31	14	1.008	1.006	0.00	-0.18%	0.18%
31	15	1.009	1.005	0.00	-0.39%	0.39%
31	16	1.008	1.005	0.00	-0.31%	0.31%
Max		1.013	1.014	0.00	0.30%	0.74%
Average		1.010	1.007	0.00	-0.22%	0.30%
Min		1.008	1.001	-0.01	-0.74%	0.12%
Std Dev		0.002	0.004	0.00	0.26%	0.15%

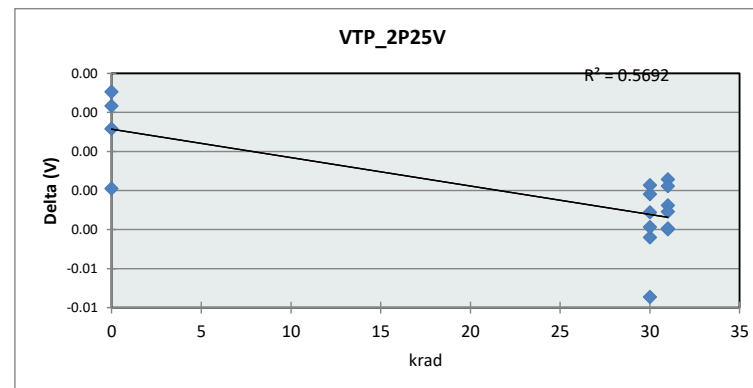

VTP_2P25V		0	30	31
Test Site	CLAB			
Tester	ETS88-01			
Test Number	EQ774601			
Units	V			
Max Limit	1.51			
Min Limit	0.51			
LL		0.51	0.51	0.51
Min		1.01	1.00	1.00
Average		1.01	1.01	1.01
Max		1.01	1.01	1.01
UL		1.51	1.51	1.51

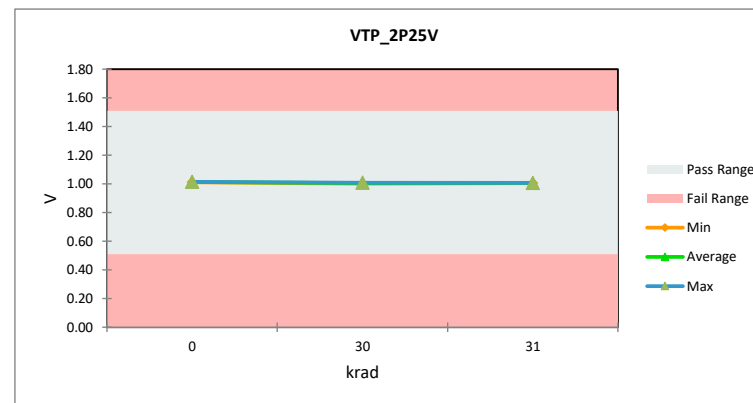

TID Report SN54SC3T98-SEP

VTP_2P75V							
Test Site	CLAB						
Tester	ETS88-01						
Test Number	EQ774601						
Units	V						
Max Limit	1.51						
Min Limit	0.51						
krad	Serial #	PreTestHDR	PostTestHDR	Delta	Delta %	% of Limit Range	
0	1	1.125	1.124	0.00	-0.11%	0.12%	
0	2	1.126	1.127	0.00	0.10%	0.11%	
0	3	1.125	1.128	0.00	0.24%	0.27%	
0	4	1.126	1.127	0.00	0.09%	0.10%	
30	5	1.123	1.120	0.00	-0.31%	0.34%	
30	6	1.125	1.119	-0.01	-0.52%	0.59%	
30	7	1.124	1.121	0.00	-0.32%	0.36%	
30	8	1.122	1.119	0.00	-0.24%	0.27%	
30	9	1.119	1.114	-0.01	-0.46%	0.52%	
30	10	1.121	1.117	0.00	-0.35%	0.40%	
31	11	1.123	1.120	0.00	-0.31%	0.34%	
31	12	1.125	1.121	0.00	-0.39%	0.44%	
31	13	1.124	1.121	0.00	-0.32%	0.36%	
31	14	1.122	1.120	0.00	-0.21%	0.24%	
31	15	1.119	1.117	0.00	-0.17%	0.19%	
31	16	1.121	1.118	0.00	-0.34%	0.38%	
Max	1.126	1.128	0.00	0.24%	0.59%		
Average	1.123	1.121	0.00	-0.23%	0.31%		
Min	1.119	1.114	-0.01	-0.52%	0.10%		
Std Dev	0.002	0.004	0.00	0.21%	0.14%		

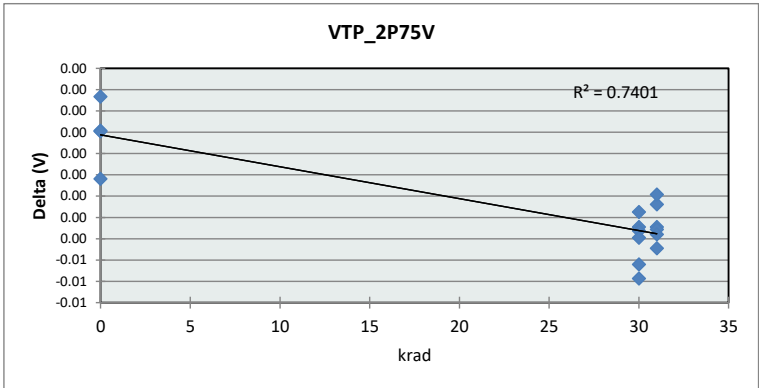

VTP_2P75V			
Test Site	CLAB		
Tester	ETS88-01		
Test Number	EQ774601		
Units	V		
Max Limit	1.51		
Min Limit	0.51		
krad	0	30	31
LL	0.51	0.51	0.51
Min	1.12	1.11	1.12
Average	1.13	1.12	1.12
Max	1.13	1.12	1.12
UL	1.51	1.51	1.51

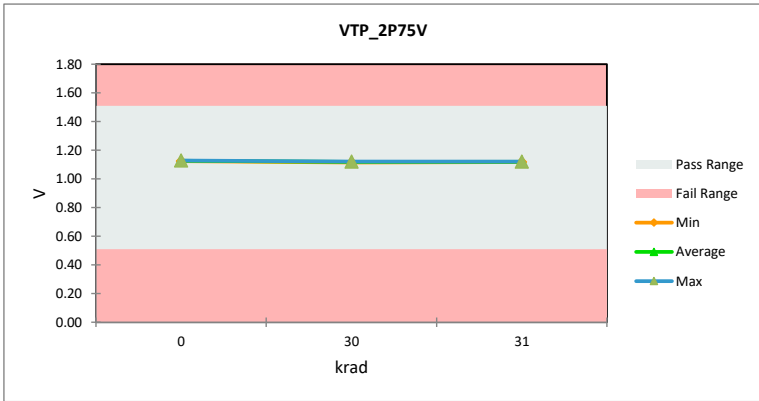

TID Report SN54SC3T98-SEP

VTP_2V	
Test Site	CLAB
Tester	ETS88-01
Test Number	EQ774601
Units	V
Max Limit	1.32
Min Limit	0.39

krad	Serial #	PreTestHDR	PostTestHDR	Delta	Delta %	% of Limit Range
0	1	0.951	0.952	0.00	0.07%	0.07%
0	2	0.951	0.953	0.00	0.28%	0.29%
0	3	0.952	0.955	0.00	0.29%	0.29%
0	4	0.951	0.952	0.00	0.12%	0.12%
30	5	0.949	0.945	0.00	-0.40%	0.41%
30	6	0.950	0.946	0.00	-0.37%	0.38%
30	7	0.948	0.946	0.00	-0.28%	0.28%
30	8	0.948	0.943	0.00	-0.46%	0.47%
30	9	0.948	0.941	-0.01	-0.76%	0.77%
30	10	0.949	0.945	0.00	-0.45%	0.46%
31	11	0.949	0.945	0.00	-0.36%	0.37%
31	12	0.950	0.946	0.00	-0.33%	0.34%
31	13	0.948	0.946	0.00	-0.23%	0.23%
31	14	0.948	0.945	0.00	-0.28%	0.29%
31	15	0.948	0.942	-0.01	-0.62%	0.63%
31	16	0.949	0.945	0.00	-0.44%	0.45%
Max		0.952	0.955	0.00	0.29%	0.77%
Average		0.949	0.947	0.00	-0.26%	0.37%
Min		0.948	0.941	-0.01	-0.76%	0.07%
Std Dev		0.001	0.004	0.00	0.30%	0.17%

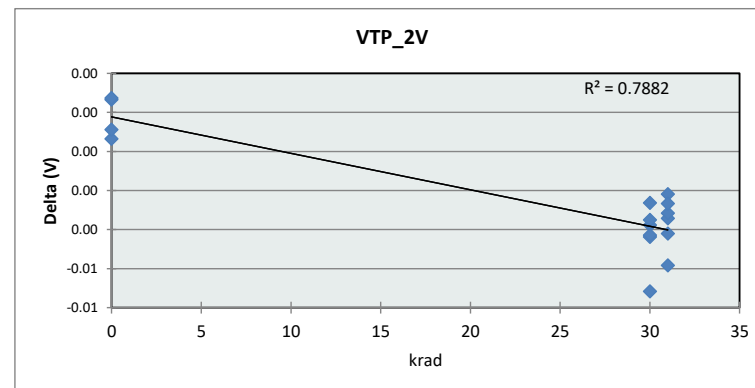

VTP_2V		0	30	31
Test Site	CLAB			
Tester	ETS88-01			
Test Number	EQ774601			
Units	V			
Max Limit	1.32			
Min Limit	0.39			
LL		0.39	0.39	0.39
Min		0.95	0.94	0.94
Average		0.95	0.94	0.95
Max		0.95	0.95	0.95
UL		1.32	1.32	1.32

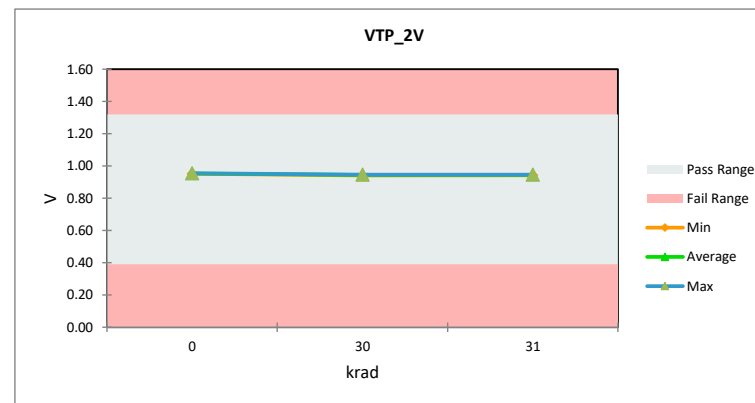

TID Report

SN54SC3T98-SEP

VTP_3P6V	
Test Site	CLAB
Tester	ETS88-01
Test Number	EQ774601
Units	V
Max Limit	1.7
Min Limit	0.65

krad	Serial #	PreTestHDR	PostTestHDR	Delta	Delta %	% of Limit Range
0	1	1.308	1.307	0.00	-0.11%	0.13%
0	2	1.310	1.311	0.00	0.12%	0.15%
0	3	1.313	1.314	0.00	0.07%	0.09%
0	4	1.312	1.313	0.00	0.06%	0.07%
30	5	1.308	1.303	-0.01	-0.40%	0.49%
30	6	1.310	1.306	0.00	-0.31%	0.39%
30	7	1.310	1.306	0.00	-0.34%	0.43%
30	8	1.307	1.305	0.00	-0.21%	0.26%
30	9	1.305	1.301	0.00	-0.28%	0.35%
30	10	1.304	1.302	0.00	-0.19%	0.24%
31	11	1.308	1.304	0.00	-0.32%	0.40%
31	12	1.310	1.305	0.00	-0.32%	0.40%
31	13	1.310	1.306	0.00	-0.34%	0.43%
31	14	1.307	1.303	0.00	-0.35%	0.44%
31	15	1.305	1.300	0.00	-0.34%	0.43%
31	16	1.304	1.301	0.00	-0.27%	0.34%
Max		1.313	1.314	0.00	0.12%	0.49%
Average		1.308	1.305	0.00	-0.22%	0.31%
Min		1.304	1.300	0.00	-0.40%	0.07%
Std Dev		0.003	0.004	0.00	0.17%	0.14%

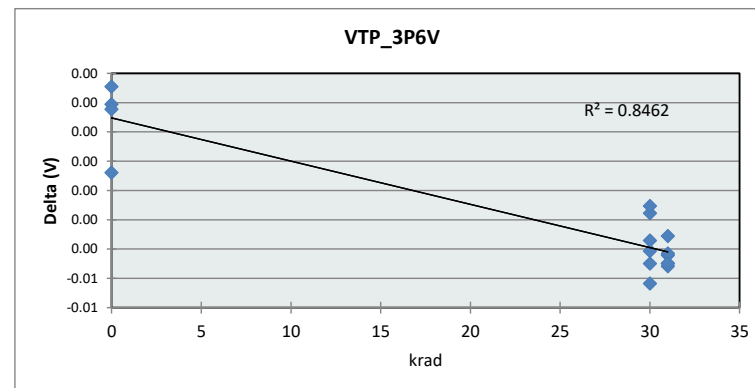

VTP_3P6V		0	30	31
Test Site	CLAB			
Tester	ETS88-01			
Test Number	EQ774601			
Units	V			
Max Limit	1.7			
Min Limit	0.65			
LL		0.65	0.65	0.65
Min		1.31	1.30	1.30
Average		1.31	1.30	1.30
Max		1.31	1.31	1.31
UL		1.70	1.70	1.70

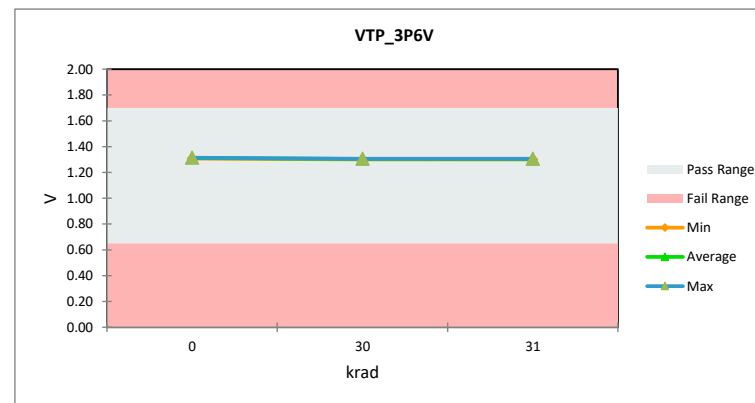

TID Report SN54SC3T98-SEP

VTP_3V							
Test Site	CLAB						
Tester	ETS88-01						
Test Number	EQ774601						
Units	V						
Max Limit	1.7						
Min Limit	0.65						
krad	Serial #	PreTestHDR	PostTestHDR	Delta	Delta %	% of Limit Range	
0	1	1.180	1.180	0.00	0.03%	0.03%	
0	2	1.181	1.181	0.00	0.03%	0.04%	
0	3	1.183	1.184	0.00	0.08%	0.09%	
0	4	1.182	1.183	0.00	0.07%	0.08%	
30	5	1.179	1.174	-0.01	-0.46%	0.51%	
30	6	1.180	1.177	0.00	-0.28%	0.32%	
30	7	1.181	1.177	0.00	-0.32%	0.36%	
30	8	1.178	1.176	0.00	-0.15%	0.16%	
30	9	1.177	1.171	-0.01	-0.44%	0.49%	
30	10	1.177	1.173	0.00	-0.36%	0.41%	
31	11	1.179	1.176	0.00	-0.28%	0.31%	
31	12	1.180	1.176	0.00	-0.35%	0.40%	
31	13	1.181	1.177	0.00	-0.34%	0.38%	
31	14	1.178	1.175	0.00	-0.27%	0.31%	
31	15	1.177	1.173	0.00	-0.34%	0.39%	
31	16	1.177	1.173	0.00	-0.36%	0.41%	
Max	1.183	1.184	0.00	0.08%	0.51%		
Average	1.179	1.176	0.00	-0.23%	0.29%		
Min	1.177	1.171	-0.01	-0.46%	0.03%		
Std Dev	0.002	0.004	0.00	0.19%	0.16%		

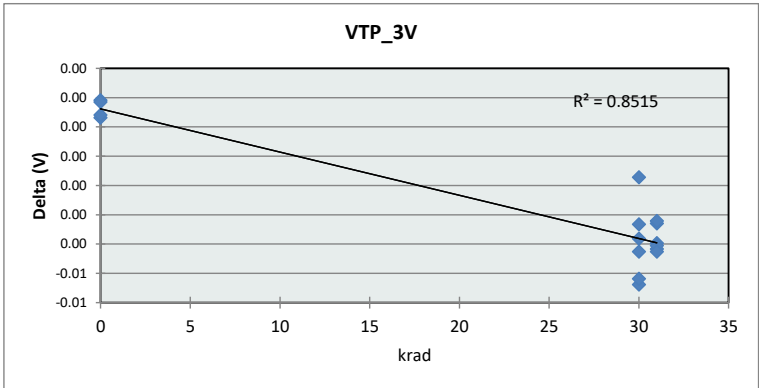

VTP_3V			
Test Site	CLAB		
Tester	ETS88-01		
Test Number	EQ774601		
Units	V		
Max Limit	1.7		
Min Limit	0.65		
krad	0	30	31
LL	0.65	0.65	0.65
Min	1.18	1.17	1.17
Average	1.18	1.17	1.17
Max	1.18	1.18	1.18
UL	1.70	1.70	1.70

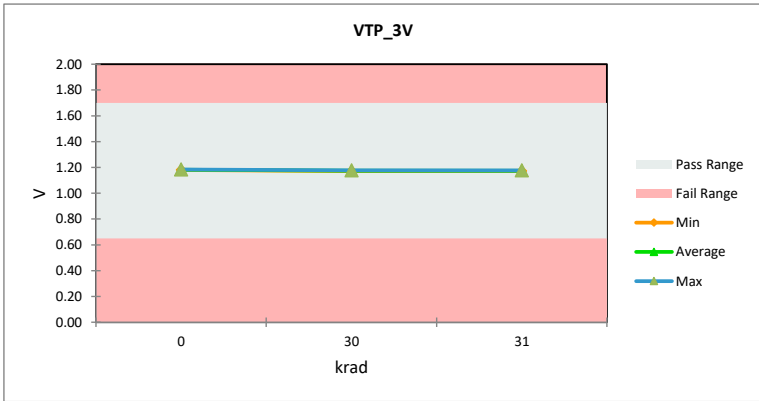

TID Report SN54SC3T98-SEP

		VTP_4P5V					
Test Site		CLAB					
Tester		ETS88-01					
Test Number		EQ774601					
Units		V					
Max Limit		2.16					
Min Limit		0.87					
krad	Serial #	PreTestHDR	PostTestHDR	Delta	Delta %	% of Limit Range	
0	1	1.497	1.497	0.00	-0.03%	0.03%	
0	2	1.501	1.501	0.00	0.01%	0.01%	
0	3	1.503	1.504	0.00	0.07%	0.08%	
0	4	1.503	1.503	0.00	0.00%	0.00%	
30	5	1.498	1.491	-0.01	-0.45%	0.52%	
30	6	1.501	1.496	0.00	-0.31%	0.36%	
30	7	1.502	1.499	0.00	-0.23%	0.27%	
30	8	1.499	1.495	0.00	-0.29%	0.34%	
30	9	1.494	1.489	-0.01	-0.34%	0.39%	
30	10	1.496	1.492	0.00	-0.27%	0.32%	
31	11	1.498	1.493	-0.01	-0.35%	0.40%	
31	12	1.501	1.495	-0.01	-0.36%	0.42%	
31	13	1.502	1.498	0.00	-0.27%	0.32%	
31	14	1.499	1.494	-0.01	-0.34%	0.39%	
31	15	1.494	1.492	0.00	-0.18%	0.20%	
31	16	1.496	1.491	-0.01	-0.37%	0.42%	
	Max	1.503	1.504	0.00	0.07%	0.52%	
	Average	1.499	1.496	0.00	-0.23%	0.28%	
	Min	1.494	1.489	-0.01	-0.45%	0.00%	
	Std Dev	0.003	0.004	0.00	0.16%	0.17%	

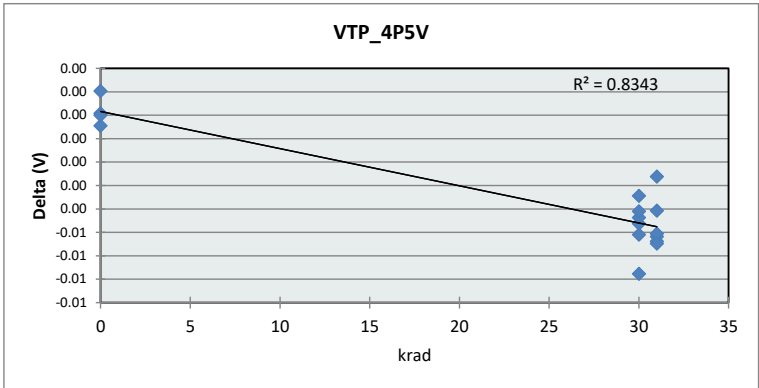

		VTP_4P5V		
Test Site		CLAB		
Tester		ETS88-01		
Test Number		EQ774601		
Units		V		
Max Limit		2.16		
Min Limit		0.87		
krad		0	30	31
LL		0.87	0.87	0.87
Min		1.50	1.49	1.49
Average		1.50	1.49	1.49
Max		1.50	1.50	1.50
UL		2.16	2.16	2.16

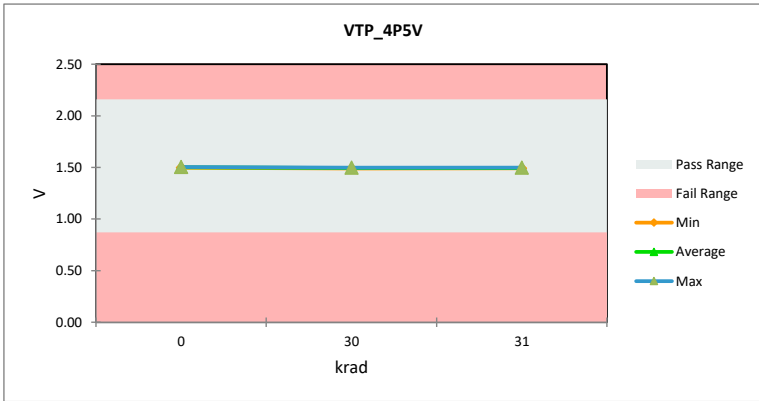

TID Report SN54SC3T98-SEP

VTP_5P5V							
Test Site	CLAB						
Tester	ETS88-01						
Test Number	EQ774601						
Units	0						
Max Limit	2.16						
Min Limit	0.87						
krad	Serial #	PreTestHDR	PostTestHDR	Delta	Delta %	% of Limit Range	
0	1	1.699	1.699	0.00	-0.01%	0.02%	
0	2	1.707	1.707	0.00	-0.01%	0.02%	
0	3	1.711	1.710	0.00	-0.02%	0.02%	
0	4	1.709	1.710	0.00	0.08%	0.10%	
30	5	1.703	1.698	0.00	-0.28%	0.37%	
30	6	1.707	1.699	-0.01	-0.46%	0.61%	
30	7	1.710	1.705	0.00	-0.28%	0.38%	
30	8	1.705	1.700	-0.01	-0.32%	0.42%	
30	9	1.698	1.694	0.00	-0.23%	0.30%	
30	10	1.701	1.697	0.00	-0.25%	0.33%	
31	11	1.703	1.698	-0.01	-0.30%	0.40%	
31	12	1.707	1.702	0.00	-0.26%	0.35%	
31	13	1.710	1.704	-0.01	-0.33%	0.43%	
31	14	1.705	1.700	-0.01	-0.31%	0.41%	
31	15	1.698	1.696	0.00	-0.14%	0.19%	
31	16	1.701	1.697	0.00	-0.22%	0.29%	
Max	1.711	1.710	0.00	0.08%			
Average	1.705	1.701	0.00	-0.21%			
Min	1.698	1.694	0.00	-0.46%			
Std Dev	0.004	0.005	0.00	0.15%			

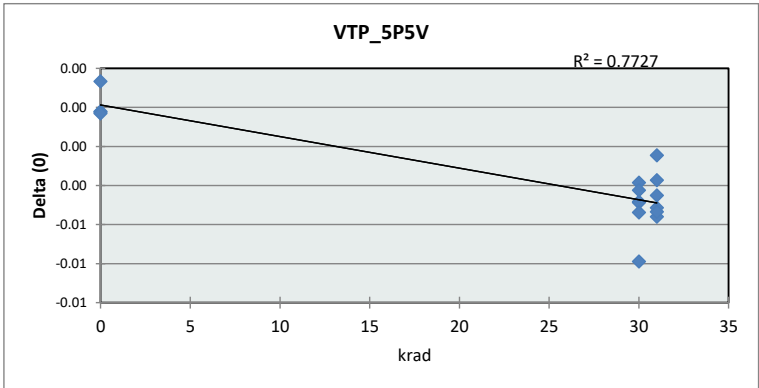

VTP_5P5V			
Test Site	CLAB		
Tester	ETS88-01		
Test Number	EQ774601		
Units	0		
Max Limit	2.16		
Min Limit	0.87		
krad	0	30	31
LL	0.87	0.87	0.87
Min	1.70	1.69	1.70
Average	1.71	1.70	1.70
Max	1.71	1.71	1.70
UL	2.16	2.16	2.16

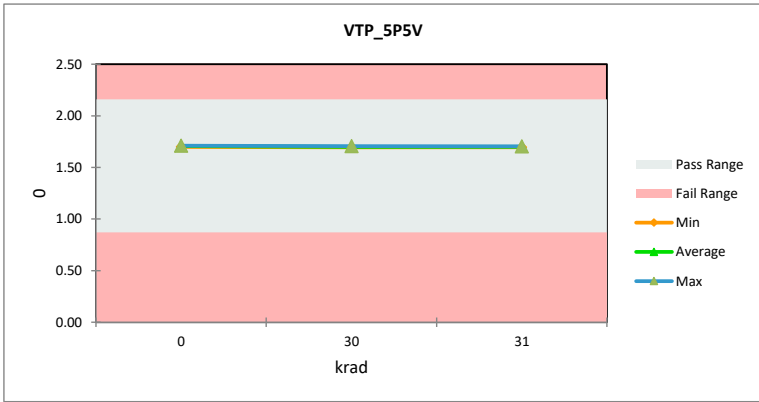

IMPORTANT NOTICE AND DISCLAIMER

TI PROVIDES TECHNICAL AND RELIABILITY DATA (INCLUDING DATA SHEETS), DESIGN RESOURCES (INCLUDING REFERENCE DESIGNS), APPLICATION OR OTHER DESIGN ADVICE, WEB TOOLS, SAFETY INFORMATION, AND OTHER RESOURCES "AS IS" AND WITH ALL FAULTS, AND DISCLAIMS ALL WARRANTIES, EXPRESS AND IMPLIED, INCLUDING WITHOUT LIMITATION ANY IMPLIED WARRANTIES OF MERCHANTABILITY, FITNESS FOR A PARTICULAR PURPOSE OR NON-INFRINGEMENT OF THIRD PARTY INTELLECTUAL PROPERTY RIGHTS.

These resources are intended for skilled developers designing with TI products. You are solely responsible for (1) selecting the appropriate TI products for your application, (2) designing, validating and testing your application, and (3) ensuring your application meets applicable standards, and any other safety, security, regulatory or other requirements.

These resources are subject to change without notice. TI grants you permission to use these resources only for development of an application that uses the TI products described in the resource. Other reproduction and display of these resources is prohibited. No license is granted to any other TI intellectual property right or to any third party intellectual property right. TI disclaims responsibility for, and you will fully indemnify TI and its representatives against, any claims, damages, costs, losses, and liabilities arising out of your use of these resources.

TI's products are provided subject to [TI's Terms of Sale](#) or other applicable terms available either on [ti.com](https://www.ti.com) or provided in conjunction with such TI products. TI's provision of these resources does not expand or otherwise alter TI's applicable warranties or warranty disclaimers for TI products.

TI objects to and rejects any additional or different terms you may have proposed.

Mailing Address: Texas Instruments, Post Office Box 655303, Dallas, Texas 75265
Copyright © 2023, Texas Instruments Incorporated