



ABSTRACT

Texas Instruments created the Ultrasonic Lens Cleaning (ULC) system for removing water, ice, or other contaminants from automotive, security, and industrial lens systems. Ultrasonic Lens Cleaning improves visibility by efficiently clearing water, ice, and some contaminants. For some use cases, Ultrasonic Lens Cleaning eliminates the need for washer tubes, spray nozzles, or wipers. The ULC System is an electromechanical system composed of a piezo based lens cover or lens system, housing, and ULC1001-DRV290x EVM. The ULC1001-DRV290x EVM is the electrical system developed to excite the Lens Cover and expel contaminants.

Table of Contents

1 General Texas Instruments High Voltage Evaluation (TI HV EVM) User Safety Guidelines	2
2 Introduction	3
3 Getting Started	4
3.1 Evaluation Kit Contents	4
3.2 Connection Procedure	5
3.3 GUI Setup	6
4 System Overview	7
4.1 System ISR Period	8
4.2 System Drive Voltage	8
4.3 System Calibration	9
4.4 System Cleaning	11
4.5 System Diagnostics	15
5 GUI Overview	15
5.1 GUI Top Level Layout	15
5.2 High Level Page	18
5.3 Register Map Page	27
5.4 I ² C Configuration Page	29
5.5 GUI Functions	29
6 Hardware Design Files	41
6.1 Schematics	41
6.2 PCB Layouts	44
6.3 Bill of Materials (BOM)	46
7 Revision History	51

List of Figures

Figure 3-1. ULC1001-DRV290xEVM Top View	6
Figure 3-2. EVM System Setup Example	6
Figure 3-3. GUI Start-up	7
Figure 4-1. System Configuration Matrix	7
Figure 4-2. LCS Impedance vs Temperature	11
Figure 4-3. Water Cleaning LCS Voltage & Current	13
Figure 4-4. Deice Cleaning LCS Voltage & Current	13
Figure 4-5. Mud Cleaning LCS Voltage & Current	14
Figure 4-6. Auto Cleaning LCS Voltage & Current	14
Figure 5-1. GUI Top Level Layout	16
Figure 5-2. GUI North Pane	16
Figure 5-3. GUI South Pane	17
Figure 5-4. Burst Parameters	18
Figure 5-5. Active Burst Example	19
Figure 5-6. Passive Burst Example	20

Figure 5-7. Calibration Mode Sequence.....	21
Figure 5-8. Calibration Settings and Parameters.....	21
Figure 5-9. Voltage and Current Sense Amplifiers.....	23
Figure 5-10. Cleaning Mode Settings.....	24
Figure 5-11. Power and Diagnostic Settings.....	26
Figure 5-12. GUI Register Map Page (Hardware Register).....	27
Figure 5-13. GUI Register Map Page (Software Registers).....	28
Figure 5-14. I ² C Configuration	29
Figure 5-15. GUI Status Bar.....	29
Figure 5-16. GUI Status Log.....	30
Figure 5-17. Script Menu.....	39
Figure 5-18. Python Recording Window.....	39
Figure 5-19. Saving Recorded Python Script.....	40
Figure 5-20. Running Recorded Python Script.....	40
Figure 6-1. ULC1001-DRV290x EVM Schematic.....	41
Figure 6-2. ULC1001-DRV290x EVM MSP430 Schematic.....	42
Figure 6-3. ULC1001-DRV290x EVM Power Supplies.....	43
Figure 6-4. Top Layer.....	44
Figure 6-5. Signal Layer 1.....	44
Figure 6-6. Signal Layer 2.....	44
Figure 6-7. Bottom Layer.....	44
Figure 6-8. Board Dimensions.....	45

List of Tables

Table 3-1. ULC1001-DRV290x EVM Port and Switch Descriptions.....	4
Table 4-1. ISR Configuration Settings.....	8
Table 4-2. Valid Calibration Bursts.....	10
Table 4-3. DC Bias Calibration Settings.....	10
Table 4-4. Valid Cleaning Bursts.....	12
Table 4-5. Valid Diagnostic Bursts.....	15
Table 5-1. Menu Bar Functions.....	17
Table 5-2. Active Burst Parameters.....	19
Table 5-3. Passive Burst Parameters.....	20
Table 5-4. Temperature Calibration Setting.....	21
Table 5-5. Cal Mode Settings.....	22
Table 5-6. Voltage and Current Sense Resistor Reference Values.....	23
Table 5-7. Mass Detect Parameters.....	24
Table 5-8. Temperature Parameters.....	25
Table 5-9. Power Parameters.....	26
Table 5-10. Diagnostic Parameters.....	26
Table 5-11. Reinit Mode Sequence.....	32
Table 5-12. Faults and Flags.....	33
Table 5-13. Read Flags and Faults Sequence.....	33
Table 5-14. Clear Flags and Faults Sequence.....	33
Table 5-15. Calibration Mode Sequence.....	35
Table 5-16. Cleaning Mode Sequence.....	36
Table 5-17. Diagnostic Mode Sequence.....	36
Table 5-18. Abort Sequence.....	37
Table 6-1. ULC1001-DRV290X EVM Bill of Materials.....	46

Trademarks

Bode 100™ is a trademark of OMICRON electronics.
All trademarks are the property of their respective owners.

1 General Texas Instruments High Voltage Evaluation (TI HV EVM) User Safety Guidelines

Always follow TI's setup and application instructions, including use of all interface components within the recommended electrical rated voltage and power limits. Always use electrical safety precautions to help maintain your personal safety and those working around you. Contact TI's Product Information Center <http://ticsc.service-now.com> for further information.

Save all warnings and instructions for future reference.

WARNING

Failure to follow warnings and instructions can result in personal injury, property damage, or death due to electrical shock and burn hazards.

The term TI HV EVM refers to an electronic device typically provided as an open-framed unenclosed printed circuit board assembly. The TI HV EVM is intended strictly for use in development laboratory environments, solely for qualified professional users who have training, expertise, and knowledge of electrical safety risks in development and application of high voltage electrical circuits. Any other use or application are strictly prohibited by Texas Instruments. If the user is not qualified, then immediately halt further use of the HV EVM.

1. 1. Work Area Safety a. Keep work area clean and orderly.
 - a. Qualified observers must be present anytime circuits are energized.
 - b. Effective barriers and signage must be present in the area where the TI HV EVM and the interface electronics are energized. For the purpose of protecting inadvertent access, these signs must indicate operation of accessible high voltages can be present.
 - c. All interface circuits, power supplies, evaluation modules, instruments, meters, scopes and other related apparatus used in a development environment exceeding 50 Vrms / 75 VDC must be electrically located within a protected Emergency Power Off EPO protected power strip.
 - d. Use stable and non-conductive work surface.
 - e. Use adequately insulated clamps and wires to attach measurement probes and instruments. No free-hand testing whenever possible.
2. Electrical Safety: As a precautionary measure, a good engineering practice is to assume that the entire EVM has fully accessible and active high voltages.
 - a. De-energize the TI HV EVM and all the inputs, outputs, and electrical loads before performing any electrical or other diagnostic measurements. Confirm that the TI HV EVM power has been safely de-energized.
 - b. With the EVM confirmed de-energized, proceed with required electrical circuit configurations, wiring, measurement equipment connection, and other application needs, while still assuming the EVM circuit and measuring instruments are electrically live.
 - c. After EVM readiness is complete, energize the EVM as intended.

WARNING

WARNING ELECTRICAL SHOCK HAZARD.

WHILE THE EVM IS ENERGIZED, NEVER TOUCH THE EVM OR THE ELECTRICAL CIRCUITS BECAUSE THERE CAN BE HIGH VOLTAGES CAPABLE OF CAUSING ELECTRICAL SHOCK HAZARD.

3. Personal Safety: Wear personal protective equipment (for example, voltage rated gloves or safety glasses with side shields) or protect the EVM in an adequate protective closure with interlocks to protect from accidental touch.
4. Limitation for safe use: EVMs are not to be used as all or part of a production unit.

2 Introduction

Ultrasonic Lens Cleaning is a new way to clean lenses without any bulky components. ULC is highly effective at clearing water or ice, and significantly improves visibility with contaminants such as mud or dirt. For strict cleaning applications, ULC can pair with a water jet. Compared with a traditional water jet system, ULC eliminates the need for a complimentary air jet system and reduces water consumption.

Texas Instruments created the Ultrasonic Lens Cleaning (ULC) system for removing water, ice, or other contaminants from cover lenses in automotive and industrial systems. This technology uses a carefully manufactured mechanical system comprised of a piezo transducer glued directly, or indirectly through a bracket, to a lens (glass or other materials) that can be placed over the camera or in the camera stack. A glued transducer and lens combination intended to cover a camera module is called a Lens Cover. The Lens Cover is mounted inside a housing creating the Lens Cover System (LCS). For the purpose of this document, LCS refers

to a lens cover system as well as an integrated piezo-based lens cleaning system. The ULC1001-DRV290x EVM is the electrical system developed to drive the piezo element of the LCS causing expulsion of contaminants from the lens through mechanical vibrations. This EVM is easily controlled via I²C using the available PC based GUI. The schematic is shown in [Section 6.1](#).

Texas Instruments develops prototype mechanical systems and production ready electrical systems required for Ultrasonic Lens Cleaning. Mechanical systems developed by other companies can also be driven with the ULC1001-DRV290x EVM. Texas Instruments' LCS is designed using specific parameters and components to provide high reliability and excellent cleaning performance. For more mechanical details on the LCS, please refer the Mechanical Design Guides.

The ULC1001-DRV290x EVM is a flexible system designed to eliminate design complexities for ultrasonic lens cleaning applications. Through the GUI, users can quickly start developing and evaluating ultrasonic lens cleaning applications. Alternatively, four programmable buttons on the EVM can be programmed to drive specific cleaning modes using the on-board MSP430. The ULC1001-DRV290x EVM contents are listed in [Section 3.1](#).

3 Getting Started

The ULC1001-DRV290x EVM can be set up to drive multiple types of Lens Cover Systems. The EVM contains a flexible boost converter design and multiple filter configurations in the output path. Use the following instructions for assembling the hardware and installing the software components of the system.

CAUTION

The piezo transducer in the LCS can become electrically charged due to electric fields or temperature changes. Before connecting the LCS to the ULC1001-DRV290x EVM, short the leads of the LCS to discharge any potential.

3.1 Evaluation Kit Contents

The ULC1001-DRV290x EVM is not outfitted with any additional hardware, but TI recommends to purchase the [USB2ANY](#) for connecting the GUI to the computer. TI has open source design LCS prototypes that can be purchased to fully evaluate the ultrasonic lens cleaning technology. When using different lens covers, considering and updating the boost voltage and LC filter on the EVM is important. More information on TI lens cover prototypes and details regarding the EVM updates to be made can be found in the Mechanical Design Guides. Other lens cover systems can be tested using the ULC1001-DRV290X EVM as well.

The ULC1001-DRV290x EVM has two input power connectors, one screw down terminal block (J6) and one 2.5mm barrel jack (J4). The output is connected through the J5 terminal block at the bottom of the board. An on-board MSP430 controls four push buttons with default configurations and a USB2ANY can be connected through the J1 header.

[Table 3-1](#) lists the descriptions for all connections, jumpers, and switches on the EVM.

Table 3-1. ULC1001-DRV290x EVM Port and Switch Descriptions

Port	Description
J1	USB2ANY port compatible with the 10-pin cable that ships with the USB2ANY. Pin 6 is GND. Pin 9 is SCL. Pin 10 is SDA.
J2	Micro-USB port for MSP430.
J3	JTAG programmer for USB2ANY.
J4	Power Supply input barrel jack, 2.5mm. Input 9V-16V, 8A. (Use either J6 of J4).
J5	Output terminal block, possible output range of 0-250Vp, 3.5A, 10kHz-400 kHz depending on load and filter configuration. Terminal block rated for 300V, 15A.
J6	Power Supply input terminal block. Input 9V-16V, 8A. (Use either J6 of J4).
J7	Power connection between converters and the DRV290x device for 12V, GND, and PVDD.
J8	Pin header for disconnecting the MSP430 SCL connection.
J9	Power connection from converters to the ULC1001 and MSP430 for GND and 3.3V.

Table 3-1. ULC1001-DRV290x EVM Port and Switch Descriptions (continued)

Port	Description
J10	Pin header for disconnecting the MSP430 SDA connection.
J11	UART connection to the MSP430.
S1	Power switch for entire EVM. Disconnects the input supply from the converter circuits.
S2	I2C address select switch. Pulls AD0 on ULC1001 to VDD or GND. Replacing R19 and R13 with 10kΩ resistors enables additional I2C addresses.
S3	Shutdown switch for ULC1001 (SDZ). SDZ is pulled low when switch S3 is pushed.
S4	Run Water mode continuously from MSP430. 2nd press stops the continuous Water mode.
S5	Run Auto mode continuously from MSP430. 2nd press stops the continuous Auto mode.
S6	Run Water mode from MSP430.
S7	Run Calibration from MSP430.
S8	BSL (Bootstrap Loader) for MSP430 programming.

3.2 Connection Procedure

The ULC1001-DRV290xEVM image is shown in [Figure 3-1](#). The entire EVM, LCS, and USB2ANY setup is shown in [Figure 3-2](#). Follow these instructions to setup the system.

1. Flip PWR switch off (off = O).
2. With the power supply unplugged or off, connect to J4 or J6. Input 9V-16V, 8A. The 8A current is based on load requirements.
3. Make sure the LCS or load is discharged and plug the LCS cable into the J5 terminal block. Output, 0Vp-250Vp, 3.5A, 10kHz-400 kHz.
4. Connect the 10-pin I²C ribbon cable from the ULC1001-DRV290x EVM to the USB2ANY using J1.
5. Connect the mini USB cable from the USB2ANY into the computer.
6. Verify all safety procedures are followed before powering on the device (for example, personal protective equipment or a protective enclosure for the EVM setup).
7. Turn on the power supply.
8. Flip the Power Switch switch to the on position (on = I).
9. Download and install the ULC1001 GUI available on [TI mySecureSoftware](#).

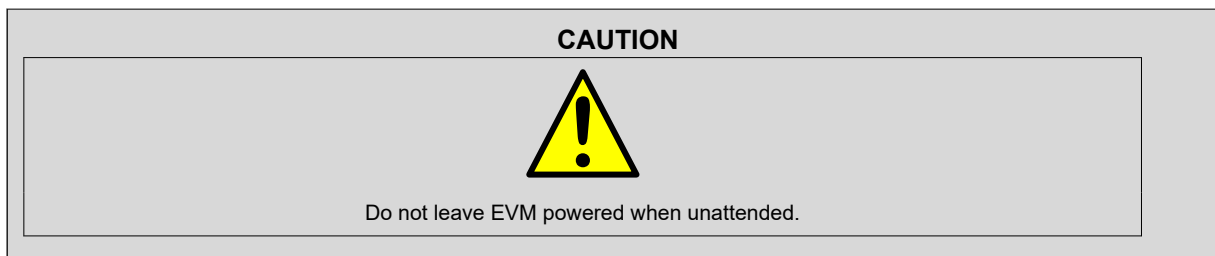

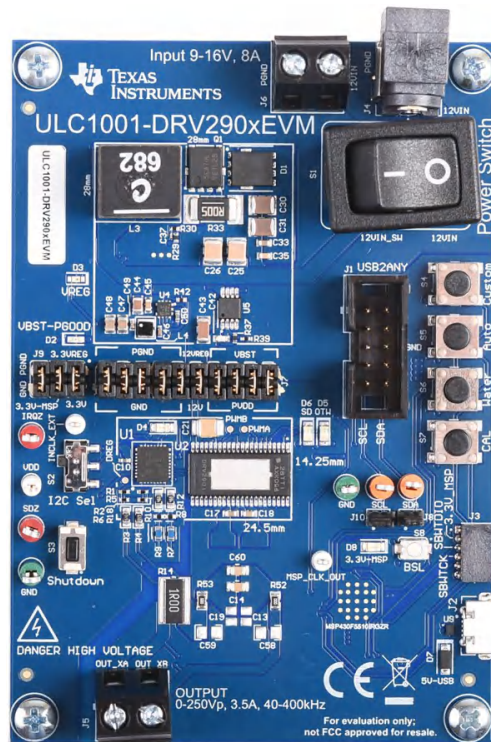

Figure 3-1. ULC1001-DRV290xEVM Top View

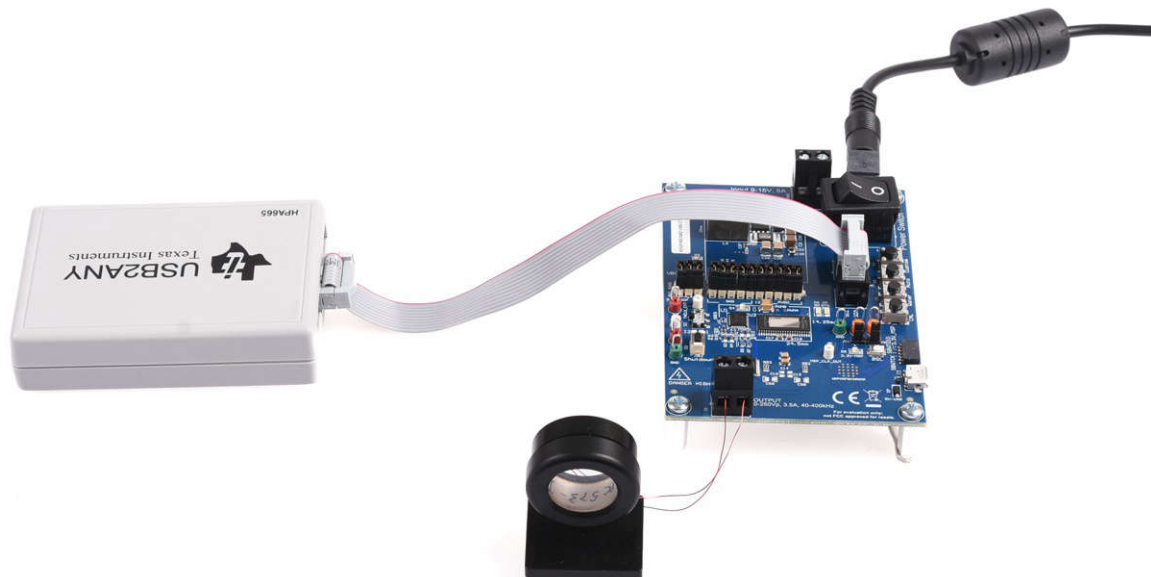

Figure 3-2. EVM System Setup Example

3.3 GUI Setup

Install and open the ULC1001 GUI available on [Ti.com](https://www.ti.com). For EVMs marked A1, use GUI version 2.4. The Default Installation directory is **C:\Program Files (x86)\Texas Instrument\ULC1001**. A license agreement must be accepted and Python 2.7 is installed as an additional dependency.

The main GUI screen is shown in [Figure 3-3](#). The default 7-bit EVM I2C Address is 0x48. When opened, the GUI automatically attempts to connect with the ULC1001-DRV290x EVM via the USB2ANY interface. Upon successful connection, the green lit *connected* indicator appears in the bottom right corner of the status bar

There are two types of bursts: Active bursts enable the IV sense path (bursts 0 to 5 and 19 to 23) and Passive bursts do not enable the IV sense path (bursts 6 to 17). Each burst contains the following eight configurable parameters: Amp, Delay, and Duration, Freq_Start, Freq_Stop, Num_Freq, Delta_Freq, and Modulation.

Note

Burst 18 is an Idle burst, which is returned to automatically at the end of each mode; this burst is never set by the user. Burst 18 must not be placed in the mode sequences. Burst 23 is the Temperature burst, which can be enabled to run continuously. For information on adding Burst 23 to a sequence, refer to [Section 5.2.3.1](#).

All Active burst frequency settings, except burst 0, must follow the following: $\Delta_{\text{Freq}} * n = (F_s / N) * n = (\text{ULC_RX_mode_cfg bits [0-4]} / \text{USER_Params_numSamples}) * n$, where n is an integer multiplier. $\text{Freq_start} \leq \text{Freq_stop}$. Freq_start and Freq_stop must be integer multiples of Δ_{Freq} . Refer to [Table 5-2](#).

All Passive bursts must have $\text{Num_Freq} = 0$. Refer to [Table 5-3](#).

There are two types of registers to be programmed. Hardware (HW) registers, which are 8-bits, setup the hardware configurations such as the ADC sample rate. Firmware (FW) registers, which are 32-bits and follow a Q-point notation, setup the firmware inside the DSP. FW registers' Q-point notation is defined by the suffix of each register; if no suffix exists, then the register is a normal 32-bit register. FW registers are stored in an I2C buffer and are not used by the firmware until the re-initialization command is invoked. Refer to [Section 5.5.3](#) for running the re-initialization command.

4.1 System ISR Period

The ULC1001 can be configured to run at different ISR periods to accommodate different types of Lens Cover Systems. The ISR period is inversely related to the ADC sample rate, F_s , and inversely related to the minimum frequency step size for active bursts, 512. The ISR period can be adjusted by changing the hardware register `ULC_RX_mode_cfg`, which must be equal to the software register `USER_Params_fs_Hz_Q9`. The hardware register sets the PLL Clock divider ratio used to configure F_s . The software register is used to configure the algorithm settings for processing current and voltage sense data. The relationship is $\text{ISR period} = 512 / F_s$, where 512 is the `USER_Params_blockSize`.

The default ISR period is $512 / 500 \text{ kps} = 1.024 \text{ ms}$. All the timings in the GUI, such as duration or delay, are scaled to the ISR period. The GUI updates timings accordingly when F_s is changed. Recommended sample rates are 400 kps and 500 kps.

When the ADC sample rate is changed, the Δ_{Freq} setting for all active bursts is also changed. The relationship is $\Delta_{\text{Freq}} = F_s / N$, where N is the number of samples. When driving high-Q transducers, the Δ_{Freq} can be minimized by setting the minimum F_s and maximum N. Valid number of samples are 512, 1024, and 2048.

To achieve a lower sample rate and ultimately a lower minimum output frequency, enable manual clocking mode. The valid PLL Clocks for manual clocking mode are 40MHz, 60MHz, and 80MHz. When in manual clock mode, all burst timings and active mode burst frequencies must be scaled appropriately. Refer to the ULC1001-Q1 data sheet for an example of changing the PLL Clock to 80MHz and adjusting all dependent registers.

Table 4-1. ISR Configuration Settings

<code>ULC_SAR_SAMP_RATES</code>	Sets the internal ADC sample rate. Must also set <code>USER_Params_fs_Hz_Q9</code> to the same value.
<code>USER_Params_numSamples</code>	Sets the number of samples. Must be set equal to <code>USER_Params_blockSize * USER_Params_numStages</code> , where <code>USER_Params_blockSize = 512</code> (Do not change). GUI changes <code>USER_Params_numStages</code> to the valid settings of 1, 2, 4.

4.2 System Drive Voltage

The voltage supplied to the DRV290x chip can be adjusted depending on the Lens Cover System being driven. The on-board boost converter, [LM5155](#), creates the voltage, VBST, which is tied to PVDD through the J7 header. Adjusting the resistor feedback network, specifically R35, can change the VBST voltage and thus changing the

PVDD voltage. [Equation 1](#) describes how to modify the VBST voltage, where $V_{REF} = 1$, $R_{FBT} = R31 = 100\text{ k}$, and $R_{FBB} = R35$.

$$V_{BST} = V_{REF} \times \left(\frac{R_{FBT}}{R_{FBB}} + 1 \right) \quad (1)$$

4.3 System Calibration

The ULC1001 compensates for mechanical variances in the LCS using a sophisticated calibration routine. The calibration routine configures settings for cleaning modes, temperature protection, power monitoring, mass detection, and diagnostics. When calibrating the system, the LCS must be clear of any debris or water and near room temperature (23°C - `USER_Params_tempParams_calTemp_C_Q21` can be adjusted). Calibration needs to be repeated anytime there is a change in the impedance of the LCS, such as change in wire length or wire gauge connecting the ULC1001-DRV290x EVM to the LCS.

When the ULC1001 is connected and powered, Calibration Mode must be configured and run first. There are 5 bursts that calibrate different algorithms. The suggested order is burst 0, 5, 1, 2, 3. Each burst is described in [Table 4-2](#). The calibration sequence is shown in [Figure 5-7](#).

Table 4-2. Valid Calibration Bursts

Burst #	Burst Suffix	Description
0	CONTROL_Burst_Cal_DcBias	Calibrates the DC Bias that can appear in the current and voltage sense paths.
1	CONTROL_Burst_Cal_Region_MassDetect	Calibrates the MassDetect algorithm and updates burst 19.
2	CONTROL_Burst_Cal_Region_1	Calibrates a frequency range and updates bursts 8-11 and 16.
3	CONTROL_Burst_Cal_Region_2	Calibrates a frequency range and updates bursts 12-15 and 17.
5	CONTROL_Burst_Cal_Region_Temp	Calibrates the Temperature Constant. Single frequency measurement; Freq_start = Freq_stop.

The calibration burst can be configured for different types of systems. This user guide lists the setup for a system with two modes of vibration or two frequency ranges.

4.3.1 DC Bias Calibration

For DC Bias calibration, use CONTROL_Burst_Cal_DcBias(0); the default GUI settings must not be changed for this burst. The system does not create any output waveform for this calibration procedure. The ULC1001 determines the DC offset between the internal ADC mid-code and the measured current and voltage values with no signal input.

The remaining calibration bursts, (1-3, 5), are used to setup cleaning modes and the temperature, mass detection, and power algorithms.

Table 4-3. DC Bias Calibration Settings

Register	Value (Hex)
USER_Params_dcBiasParams_numSamples	0x00002000
USER_Params_dcBiasParams_log2NumSamples	0x0000000D
USER_Params_dcBiasParams_blockSize	0x00000200
USER_Params_dcBiasParams_numStages	0x00000010
USER_Params_burstParams_0_0_duration_cnts	0x00000011
USER_Params_burstParams_0_0_delay_cnts	0x00000001

Note

All Burst Parameters for the CONTROL_Burst_Cal_DcBias are set equal to 0 except the duration mentioned in [Table 4-3](#).

4.3.2 Temperature Calibration

The second burst in a typical calibration sequence is for temperature calibration, CONTROL_Burst_Cal_Region_Temp (5). The temperature is calibrated at a single frequency that is far from any resonance frequency in the LCS's impedance response. An example is shown in [Figure 4-2](#). The temperature slope constant, USER_Params_tempParams_slope_CperOhm_Q27, and the calibration temperature, USER_Params_tempParams_calTemp_C_Q21, must be set to properly calibrate the LCS temperature. The temperature slope is determined by measuring the LCS impedance across temperature and finding the slope of the best fit line where the x-axis is impedance and the y-axis is temperature, the inverse of the example figure. The calibration temperature, calTemp, is the ambient temperature (in Celsius) of the LCS when calibration is run. The impedance decreases as the temperature increases making the temperature slope constant negative. When the calibration sequence is run, the temperature slope constant, USER_Params_tempParams_constant_C_Q21, is set to an appropriate value.

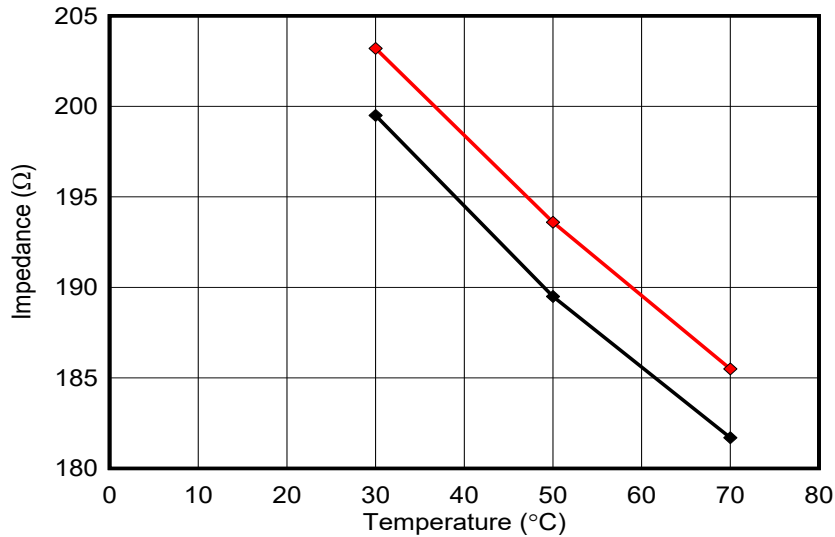

Figure 4-2. LCS Impedance vs Temperature

4.3.3 Auto Sense Calibration

The third burst in typical calibration sequence is for mass detection or Auto cleaning mode, CONTROL_Burst_Cal_Region_MassDetect (1). The frequency range for this burst is set around the minimum impedance of the LCS resonance frequency.

4.3.4 Cleaning and Power Calibration

The fourth and fifth bursts in typical calibration sequences are for calibrating cleaning modes and the Power mode, CONTROL_Burst_Cal_Region_1 (2) and CONTROL_Burst_Cal_Region_2 (3). Use both bursts (2 and 3) if the system runs on two frequencies; otherwise, use one burst. There are two custom bursts (6, 7) that are not affected by calibration. The calibration method for cleaning can be based on Peak Current (I_{max}), Peak Real Power (P_{max}), Peak Apparent Power (S_{max}), or Min Impedance (Z_{min}). For further information refer to [Table 5-5](#).

4.4 System Cleaning

Texas Instruments created three main cleaning modes for removing ice, mud, and water from the lens of the LCS and an Auto mode that can be programmed to drive a cleaning sequence when mass, such as water, is detected on the lens. Two additional custom modes are also available for flexibility. The valid bursts for cleaning modes are listed in [Table 4-4](#). As a reference, scope voltage and current waveform captures for each type of cleaning mode are depicted in the following figures: [Figure 4-3](#), [Figure 4-4](#), [Figure 4-5](#), and [Figure 4-6](#).

Table 4-4. Valid Cleaning Bursts

Burst #	Burst Name	Description
6	CONTROL_Burst_Clean_Custom_1	Custom bursts that are not updated after calibration is run.
7	CONTROL_Burst_Clean_Custom_2	
8	CONTROL_Burst_Clean_Expel_11	Burst start and stop frequencies are updated after running Calibration Region 1 burst. Different offset frequencies can be set prior to calibration.
9	CONTROL_Burst_Clean_Expel_12	
10	CONTROL_Burst_Clean_Expel_13	
11	CONTROL_Burst_Clean_Expel_14	
12	CONTROL_Burst_Clean_Expel_21	Burst start and stop frequencies are updated after running Calibration Region 2 burst. Different offset frequencies can be set prior to calibration.
13	CONTROL_Burst_Clean_Expel_22	
14	CONTROL_Burst_Clean_Expel_23	
15	CONTROL_Burst_Clean_Expel_24	
16	CONTROL_Burst_Heat_Region_1	Long bursts used for heating sequences. Burst start and stop frequencies are updated after running Calibration Region 1 and 2 bursts.
17	CONTROL_Burst_Heat_Region_2	
19	CONTROL_Burst_MassDetect	Active burst that invokes the mass detection algorithm. Burst start and stop frequencies are updated after running Calibration MassDetect burst.
23	CONTROL_Burst_Temp	Active burst that invokes the temperature protection algorithm. Burst frequency and amplitude must match the Temp Calibration settings. Temperature protection can also run continuously without setting this burst.

The Auto Cleaning Mode cleans water from the LCS lens when water is detected.

CONTROL_Burst_MassDetect (19) makes the Auto Cleaning Mode possible. As shown in [Figure 4-6](#), the MassDetect burst (19) is placed before the water and de-ice bursts (23, 16, 8, 9, 13, 14). Auto mode uses CONTROL_Burst_MassDetect to test whether the LCS has additional mass (for example, water) on the lens or not. If mass is detected, then the remaining bursts in Auto mode are run.

CONTROL_Burst_Temp (23) can be enabled using the Enable Temp checkbox, refer to [Table 5-8](#), and runs continuously on a periodic time interval. When running continuously, the Temp burst interrupts any passive bursts to check the LCS temperature. Once the temperature is measured and below the OverTemp Threshold, the mode continues to run from the interrupted location. This allows the ULC1001-DRV290X EVM to monitor the temperature of the LCS and prevent an overtemperature condition. This burst can also be added to the Auto Cleaning Mode sequence described in the above paragraph. The Temp burst (23) followed by a heating burst (16 or 17) can be added after the MassDetect burst (19) to integrate auto de-icing. Calibration mode must be run first to calibrate the Temp burst. See [Section 5.2.1](#) for details on how to set the temperature threshold through the ULC1001 GUI.

The predefined cleaning modes must be used for initial experiments. Each cleaning mode has settings that can be adjusted to improve the cleaning performance. For the most design freedom, two custom modes are also supported. Additionally, there are two custom bursts (6, 7) that are not affected by calibration. The settings for all cleaning modes are described in [Section 5.2.3](#).

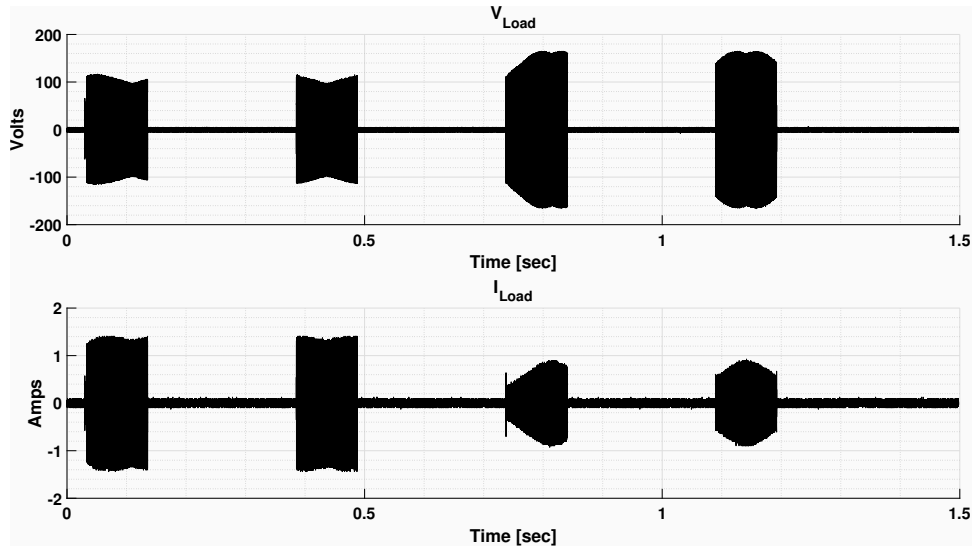

Figure 4-3. Water Cleaning LCS Voltage & Current

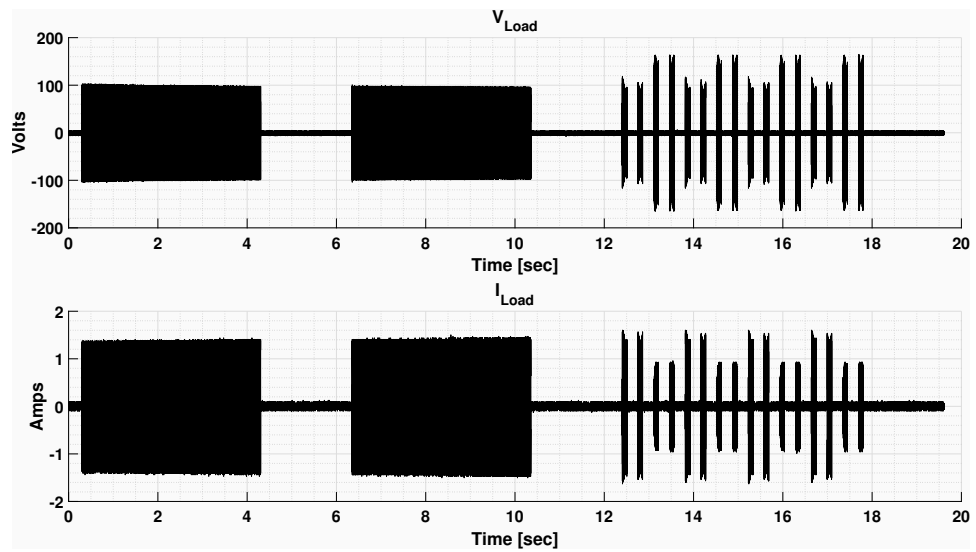

Figure 4-4. Deice Cleaning LCS Voltage & Current

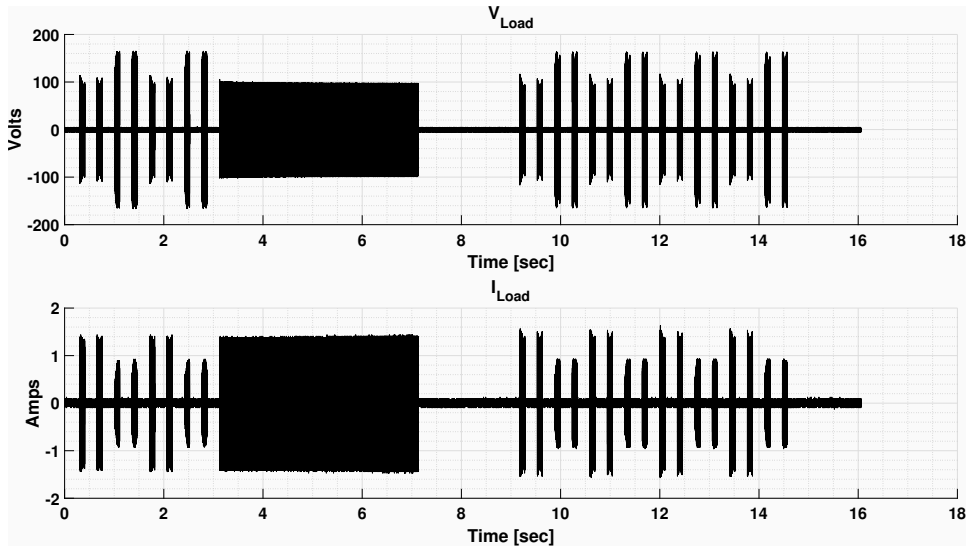

Figure 4-5. Mud Cleaning LCS Voltage & Current

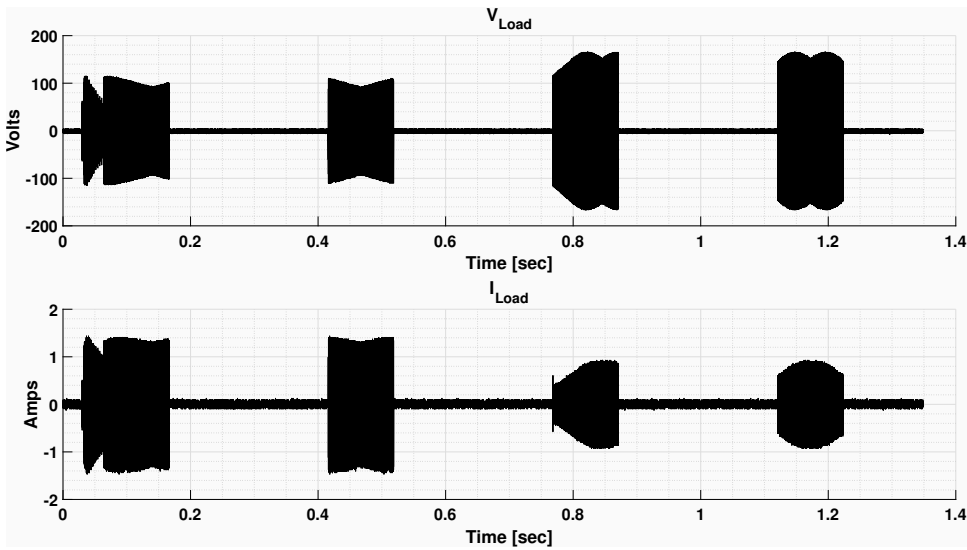

Figure 4-6. Auto Cleaning LCS Voltage & Current

4.5 System Diagnostics

Texas Instruments created two diagnostic modes for limiting power and detecting faults in the lens cover system. These modes are System Fault and Power. The valid burst for diagnostic modes are listed in [Table 4-5](#).

Table 4-5. Valid Diagnostic Bursts

Burst #	Burst Name	Description
20	CONTROL_Burst_Power_Region_1	The power bursts are used to measure the peak real power in a particular region and adjust the amplitude for the respective cleaning region based on programmable thresholds. Initially, the burst amplitude must match the respective region settings and the frequency range includes the peak power frequency.
21	CONTROL_Burst_Power_Region_2	
22	CONTROL_Burst_SystemFault	The system fault burst measures the maximum current magnitude and minimum impedance in the programmed frequency region to determine if there is an open load condition or the LCS is damaged.

Power mode can be used to regulate the power to the system. This mode can contain two burst for the two calibration frequency regions, bursts 2 and 3, respectively. There is an upper and lower power threshold for each region. After running the Power mode, the device determines a new amplitude, Amp (PuV), for the clean bursts (8-17) and the power bursts (20 and 21) to get the power into the limits set by the upper and lower thresholds. The measured power values from calibration are stored in USER_Params_baselineParams_Pmax_W_Q24_1 (region 1) and USER_Params_baselineParams_Pmax_W_Q24_2 (region 2). The LCS power values after running Power mode are stored in USER_Flags_Pmax_W_region1_Q24 and USER_Flags_Pmax_W_region2_Q24.

For the System Fault mode, a current threshold, register USER_Params_sfaultParams_Imag_threshold_A_Q9, and an impedance threshold, register USER_Params_sfaultParams_Zthreshold_ohm_Q20, must be set appropriately for the algorithms to run correctly. TI recommends a value of 200mA. The impedance of the LCS can change significantly when damaged. Therefore, the impedance threshold must be set based on the delta impedance expected when the LCS is damaged. TI recommends a value of 225Ω.

5 GUI Overview

The ULC1001 GUI is designed to assist with setting up the ULC1001 registers for the best cleaning and algorithm performance. Opening the GUI window on a Windows based PC is shown in [Figure 5-1](#). A faulty USB2ANY interface connection flags an *Interface not initialized* error message. The GUI allows users to monitor communication status, load and save configuration files, record register reads/writes from/to the ULC1001-DRV290x EVM, monitor ULC1001-DRV290x EVM faults, easily calibrate the ULC1001-DRV290x EVM, and fine tune cleaning performance. The GUI keeps ULC1001 in the Software Shutdown state, PWR_CTL = 0x10, and automatically initializes and runs the system when the mode buttons are pressed in the GUI interface. The following subsections detail the GUI components and the previously mentioned use cases.

5.1 GUI Top Level Layout

The Default GUI Window is laid out with the following three panes: North Pane, Center Pane, South Pane. Each Pane is called out in a red box in [Figure 5-1](#).

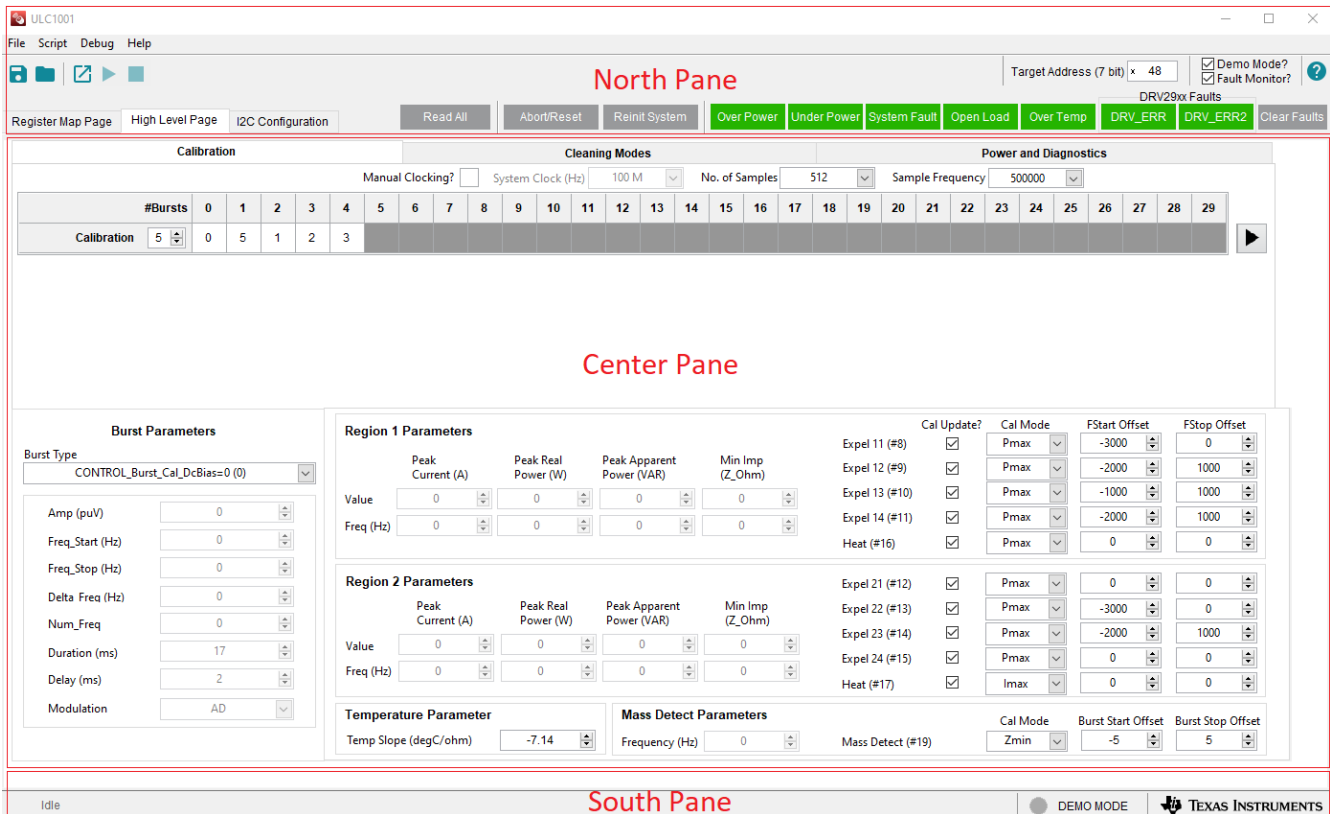

Figure 5-1. GUI Top Level Layout

5.1.1 North Pane

The GUI north pane in Figure 5-2 contains the Title bar, Menu bar, Tools Bar, page selection tabs, and various buttons, and indicators. The major functions include: configuring and monitoring communications, loading and saving configuration files, recording ULC1001-DRV290x EVM register reads and writes, monitoring system faults, aborting and re-initializing the system, changing the 7-bit target I2C address, and switching between pages.

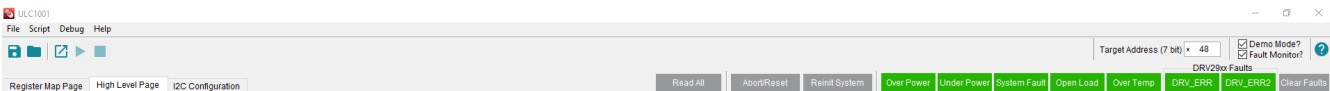

Figure 5-2. GUI North Pane

The Menu Bar lies below the tile bar in [Figure 5-2](#) and is structured as shown in [Table 5-1](#).

Table 5-1. Menu Bar Functions

Menu	Functions
File	Open Configuration, Save Configuration, Save Config Header File, Exit
Script	Launch Script Window, Start Script Recording, Stop Script Recording
Debug	Enter/Exit Demo Mode
Help	Provides Links to ULC1001-DRV290x EVM User Guide and GUI version info

Quick link buttons below the Menu Bar perform the following functions from left to right:

- Save Configuration
- Open Configuration
- Launch Script Window
- Start Recording in Script Window
- Stop Recording in Script Window

On the right side of the North Pane, additional functions exist for setting the Target I2C Address (7-bit), set/clear Demo Mode, and turn on/off periodic Fault Monitoring. The default 7 bit target address for a ULC1001-DRV290x EVM is 0x48. If the Demo Mode field box is not checked, then the GUI attempt to connect to the ULC1001-DRV290x EVM via the USB2ANY interface. When in Demo Mode, a user can navigate through the GUI to familiarize themselves with the GUI structure. The Fault Monitor period is 100ms when on.

Below the quick link buttons lies the page selection tabs. The selected page shows up on the GUI Center Pane. The default High Level Page provides the fastest way to begin evaluating the cleaning performance of the ULC1001-DRV290x EVM. The Register Map Page and I²C Configuration Page are for advanced debug and test.

To the right of the page selection tabs are the following buttons and indicators:

- Read All: Reads all registers from the ULC1001-DRV290x EVM and updates the GUI.
- Abort Sequence: This aborts the cleaning, calibration, or diagnostic mode being run.
- Reinit System: This tells the ULC1001-DRV290x EVM to reinitialize the register with the values written to the I²C buffer.
- Fault & Flag Sticky Indicators: green indicates no fault and red indicates a fault.
- Clear Faults: Clears Faults and Flags.

5.1.2 South Pane

The South Pane contains the GUI Status Bar shown in [Figure 5-3](#). The Status Bar allows communication status to monitored. Communication issues can include a faulty USB2ANY interface connection, an incorrect Target Address, or an incomplete GUI initialization. The Read/Write Indicator on the bottom left cycles quickly through register names when the GUI is reading or writing registers from the ULC1001-DRV290x EVM. If no reading or writing is in progress, then the status can be idle. Double-clicking on the Read/Write indicator opens the Status Log window, which can be used to monitor I2C transactions. The communication mode health indicator at the bottom right of the South Pane is lit yellow when not connected, lit green when connected, or gray when in demo mode.



Figure 5-3. GUI South Pane

5.1.3 Center Pane

The GUI Center Pane holds sub-panes and GUI widgets for the selected Register Map Page, High Level Page, or I²C Configuration Page. Each page is described in the next sections.

5.2 High Level Page

The High Level Page is the default page when opening the GUI and streamlines cleaning performance evaluation. The High Level Page contains three tabs for [Section 5.2.2](#), [Section 5.2.3](#), and [Section 5.2.4](#). The top section of the High Level Page shows the Mode settings. The lower right section contains multiple other settings that dynamically change when switching pages. The lower left side shows the [Section 5.2.1](#) for the selected burst, which is common to all three tabs.

5.2.1 Burst Parameters

The Burst Parameter section always displays the 8 configurable burst parameters for the selected mode. A drop-down menu can be used to see the available burst for each tab in the High Level Page. Active and Passive bursts have certain parameters that must be set to specific values for TI's algorithms to run properly. The Burst Parameters section of the GUI is shown in [Figure 5-4](#).

Active bursts enable the IV sense path (0-5, 19-23) and Passive bursts do not enable the IV sense path (6-17). Burst 18 is an Idle burst, which is returned to automatically at the end of each mode; this burst is never set by the user. Each burst contains the following eight parameters: Amp, Delay, Duration, Freq_Start, Freq_Stop, Num_Freq, Delta_Freq, and Modulation.

All Active bursts frequency settings, except burst 0, must follow the following: $\Delta_{\text{Freq}} \cdot n = (F_s/N) \cdot n = (\text{ULC_RX_mode_cfg bits [0-4]}/\text{USER_Params_numSamples}) \cdot n$, where n is an integer multiplier. $\text{Freq_start} \leq \text{Freq_stop}$. Freq_start and Freq_stop must be integer multiples of Δ_{Freq} . [Table 5-2](#) shows the settings for Active Burst Parameters. [Figure 5-5](#) shows a depiction of how an active burst is run.

All Passive bursts must have $\text{Num_Freq} = 0$. For a Passive burst, the frequency sweeps from F_{start} to F_{stop} at a rate of $\Delta_{\text{Freq}}/\text{ISR rate}$. When $F_{\text{start}} = F_{\text{stop}}$, Δ_{Freq} must be set to 0Hz. [Table 5-3](#) shows the settings for Passive Burst Parameters. [Figure 5-6](#) shows a depiction of how passive bursts are run.

Burst Parameters

Burst Type

Amp (puV)	<input type="text" value="0.8"/>
Freq_Start (Hz)	<input type="text" value="148437.5"/>
Freq_Stop (Hz)	<input type="text" value="161132.81"/>
Delta Freq (Hz)	<input type="text" value="976.56"/>
Num_Freq	<input type="text" value="14"/>
Duration (ms)	<input type="text" value="2.05"/>
Delay (ms)	<input type="text" value="2.05"/>
Modulation	<input type="text" value="HEDD"/>

Figure 5-4. Burst Parameters

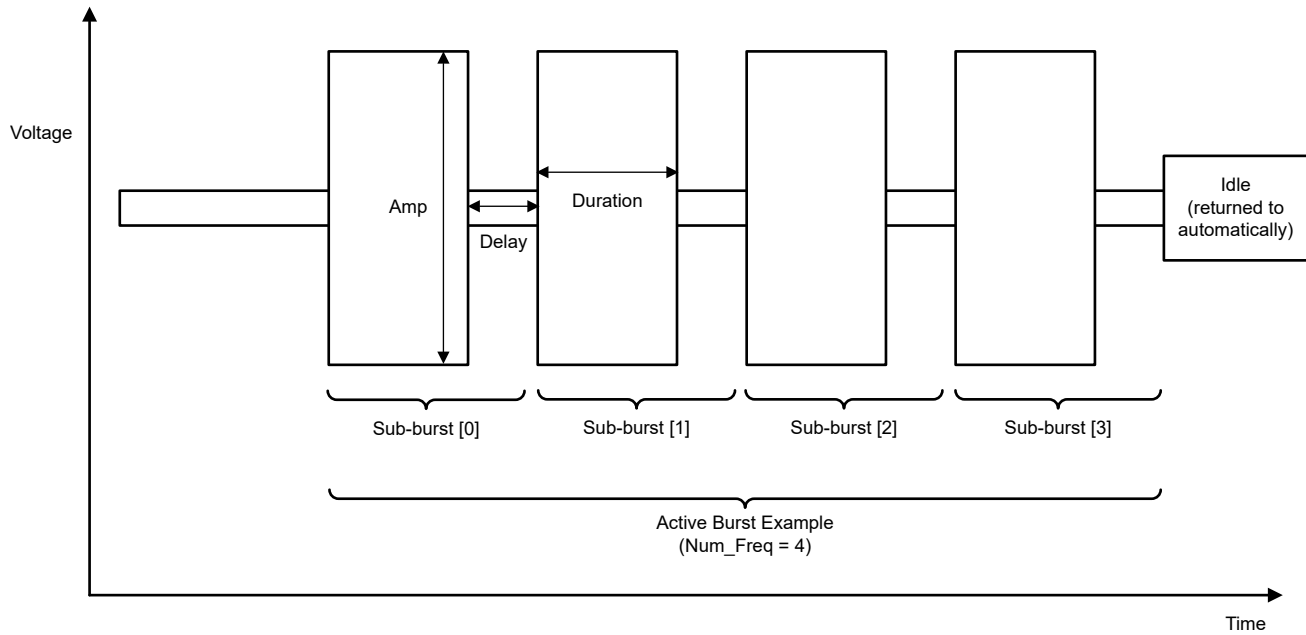

Figure 5-5. Active Burst Example

Table 5-2. Active Burst Parameters

Bursts (0-5, 19-23)

Burst Parameter	Description
Amp [puV]	Burst excitation duty cycle that drives the LCS defined in PerUnit Value from 0 to 1. Chosen by user.
Freq_Start [Hz]	Start of frequency content in burst. $\text{Freq_start} \leq \text{Freq_stop}$. Chosen by user. Auto-snap to valid value by GUI.
Freq_Stop [Hz]	Stop of frequency content in burst. $\text{Freq_stop} \geq \text{Freq_start}$. Chosen by user. Auto-snap to valid value by GUI.
Delta_Freq [Hz]	Delta frequency for each frequency step between Freq_Stop and Freq_Start. GUI default is always 976.56Hz for ULC1001-DRV290x EVM. $\text{Delta_Freq} = \text{Fs}/\text{N}$. Auto-updated by GUI.
Num_Freq	Equals $((\text{Freq_Stop} - \text{Freq_Start})/\text{Delta_Freq}) + 1$. Auto-updated by GUI.
Duration [ms]	Duration for which each excitation frequency drives the LCS. Duration must equal $\text{USER_Params_numStages} + 1$ (default is 2 ISR periods, 2ms). Auto-updated by GUI.
Delay [ms]	The additional delay placed at the end of each frequency step between Freq_Start and Freq_Stop.
Modulation	Changes modulation method between Direct Drive and standard AD modulation. AD modulation uses a carrier frequency that is 10 times the programmed frequency.

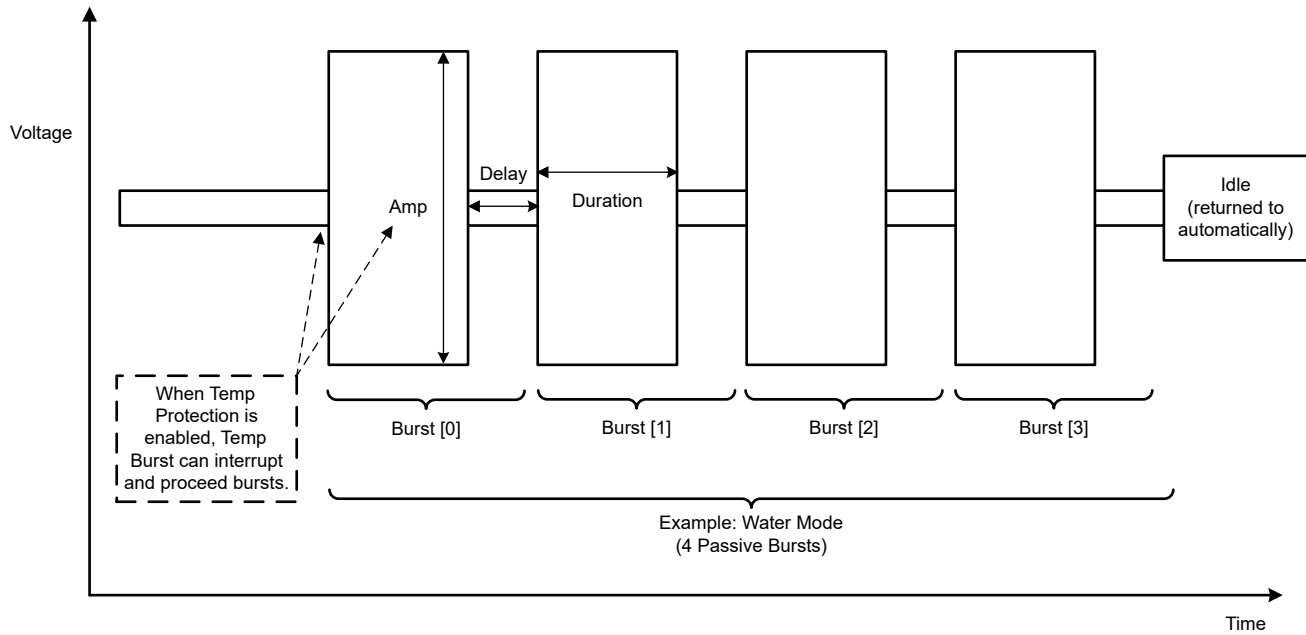

Figure 5-6. Passive Burst Example

Table 5-3. Passive Burst Parameters

Burst Parameter	Description
Amp [puV]	Burst excitation duty cycle that drives the LCS defined in PerUnit Value from 0 to 1. Chosen by user.
Freq_Start [Hz]	Start of frequency content in burst. $Freq_start \leq Freq_stop$. Auto updated after calibration.
Freq_Stop [Hz]	Stop of frequency content in burst. $Freq_stop \geq Freq_start$. Auto updated after calibration.
Delta_Freq [Hz]	Delta frequency is the change in frequency per the ISR time step. If $Fstart = Fstop$, then set $Delta_Freq = 0$. GUI default is 40Hz for ULC1001-DRV290x EVM.
Num_Freq	For Passive bursts, $Num_Freq = 0$.
Duration [ms]	Duration for each excitation frequency drives the LCS. GUI default is 98 ISR periods, 100ms for ULC1001-DRV290x EVM.
Delay [ms]	The additional delay placed at the end of the burst.
Modulation	Changes modulation method between Direct Drive and standard AD modulation. AD modulation uses a carrier frequency that is 10 times the programmed frequency.

5.2.2 Calibration Settings

When the ULC1001-DRV290x EVM is connected and powered, run Calibration Mode first. The ULC1001 Calibration mode measures multiple electrical parameters such as impedance, real and apparent power, and the current magnitude for programmed frequency ranges. These measurements are used to setup cleaning modes, temperature protection, power monitoring, mass detection, and diagnostics. Refer to [Section 4.3](#) for details on the calibration bursts. The calibration mode sequence is shown in [Figure 5-7](#). The calibration parameters and settings are shown in [Figure 5-8](#). See [Section 5.5.5](#) for a step-by-step tutorial on configuring the Calibration Mode settings and running Calibration.

Note

Three scale factors must be programmed correctly for the current and voltage sense data use in Active bursts to be correct. USER_Params_ohms_sf_Q22, USER_Params_watts_sf_Q18, and USER_Params_Imag_max_sf_Q27. See [Section 5.2.2.1](#).

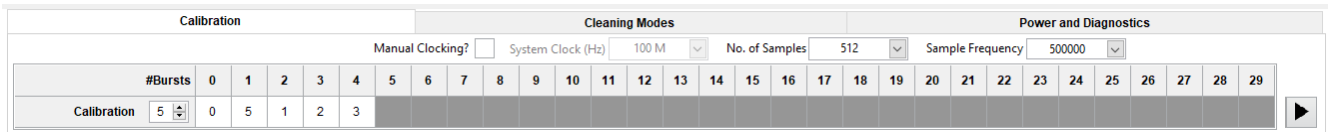

Figure 5-7. Calibration Mode Sequence

For good calibration, the enumerated calibration sequence is as follows:

- 0 - CONTROL_Burst_Cal_DcBias
- 5 - CONTROL_Burst_Cal_Region_Temp
- 1 - CONTROL_Burst_Cal_Region_MassDeetect
- 2 - CONTROL_Burst_Cal_Region_1
- 3 - CONTROL_Burst_Cal_Region_2

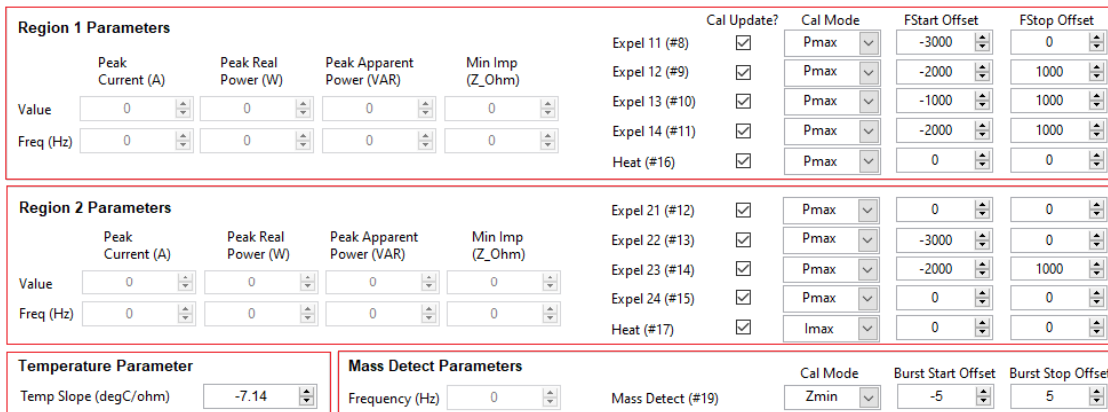

Figure 5-8. Calibration Settings and Parameters

Refer to the [Section 4.3.2](#) for details on the temperature slope setting.

Table 5-4. Temperature Calibration Setting

Parameter	Description
Temperature Slope [°C / Ω]	LCS temperature estimation algorithm slope; provided by TI for provided LCS in ULC1001-DRV290x EVM kit contents.

CAUTION

Operating the LCS above 65°C can reduce the operating lifetime and potentially damage the LCS and is dependent on the mechanical Lens Cover System.

The region parameters are returned after running the Region 1 and Region 2 calibration sequences. The registers linked to these fields are USER_Params_baselineParams, where the suffix describes the parameter. Each region parameter has an associated frequency that is used for updating the cleaning mode bursts based on the Cal Mode setting on the right side of the calibration settings page. These parameters are peak current, peak real power, peak apparent power, and minimum impedance described in [Table 5-5](#). All region parameters are returned regardless of the Cal Mode setting, but only the frequency used in the Cal Mode setting is used for the calibration algorithm. These Cal Mode settings are listed below:

- USER_Params_controlParams_calMode_8 for Clean_Expel_11 (8)
- USER_Params_controlParams_calMode_9 for Clean_Expel_12 (9)
- USER_Params_controlParams_calMode_10 for Clean_Expel_13 (10)
- USER_Params_controlParams_calMode_11 for Clean_Expel_14 (11)
- USER_Params_controlParams_calMode_12 for Clean_Expel_21 (12)
- USER_Params_controlParams_calMode_13 for Clean_Expel_22 (13)
- USER_Params_controlParams_calMode_14 for Clean_Expel_23 (14)
- USER_Params_controlParams_calMode_15 for Clean_Expel_24 (15)
- USER_Params_controlParams_calMode_16 for Heat_Region_1 (16)
- USER_Params_controlParams_calMode_17 for Heat_Region_2 (17)
- USER_Params_controlParams_calMode_19 for massDetect (19)

Table 5-5. Cal Mode Settings

Cal Mode	Description
I _{max}	Maximum current magnitude in the region.
P _{max}	Maximum real power in the region.
S _{max}	Maximum apparent power in the region.
Z _{min}	Minimum impedance magnitude in the region.

The two columns, F Start Offset and F Stop Offset, hold the frequency offset values for the calibration algorithm. Bursts 8-17 are updated based on the frequency values. Since Burst 19 is an active burst, the start and stop frequencies are updated based on an integer Burst Offset value. Therefore, Burst 19 is updated based on the calibrated frequency value $\pm \Delta_{\text{Freq}} * n$, where $\Delta_{\text{Freq}} = F_s / N$ and n is an integer.

As stated previously, the Region 1 calibration burst (2) updates cleaning bursts 8-11 and heating burst 16 and the Region 2 calibration burst (3) updates cleaning bursts 12-15 and heating burst 17. When running calibration, only the cleaning and heating bursts whose control bits are enabled are updated. This allows for only specific bursts to be updated in a re-running of calibration, opposed to all bursts for the region. In the GUI, these can be enabled / disabled with the check box below *Cal Update?*. These enable settings are also listed below:

- USER_Params_Update_Expel_11 for Region 1 Clean_Expel_11 (8)
- USER_Params_Update_Expel_12 for Region 1 Clean_Expel_12 (9)
- USER_Params_Update_Expel_13 for Region 1 Clean_Expel_13 (10)
- USER_Params_Update_Expel_14 for Region 1 Clean_Expel_14 (11)
- USER_Params_Update_Expel_21 for Region 2 Clean_Expel_21 (12)
- USER_Params_Update_Expel_22 for Region 2 Clean_Expel_22 (13)
- USER_Params_Update_Expel_23 for Region 2 Clean_Expel_23 (14)
- USER_Params_Update_Expel_24 for Region 2 Clean_Expel_24 (15)
- USER_Params_Update_Heat_Region_1 for Region 1 Heat_Region_1 (16)
- USER_Params_Update_Heat_Region_2 for Region 2 Heat_Region_2 (17)

5.2.2.1 Voltage and Current Sense Circuitry

Each input into the ULC1001 current and voltage sense amplifiers require a voltage divider to decrease the high voltage across the transducer from 0V to 0.9V. The circuit representation of the current and voltage sense amplifiers is shown in Figure 5-9, where the items in I-sense Amp and V-sense Amp are internal to ULC1001. The resistors used in the voltage dividers must have a 0.1% tolerance to achieve high accuracy for power measurements. Three scale factors, USER_Params_ohms_sf_Q22, USER_Params_watts_sf_Q18, and USER_Params_Imag_max_sf_Q27, are used to convert the measured values into power, impedance, and current values, respectively. Use the below equation to determine the scale factors and the current and voltage sense amplifier gains. Table 5-6 containing typical resistor values for common voltage levels.

Note

The equivalent resistance between VDD and GND must be $\geq 4k\Omega$. R_F is fixed to 84k Ω .

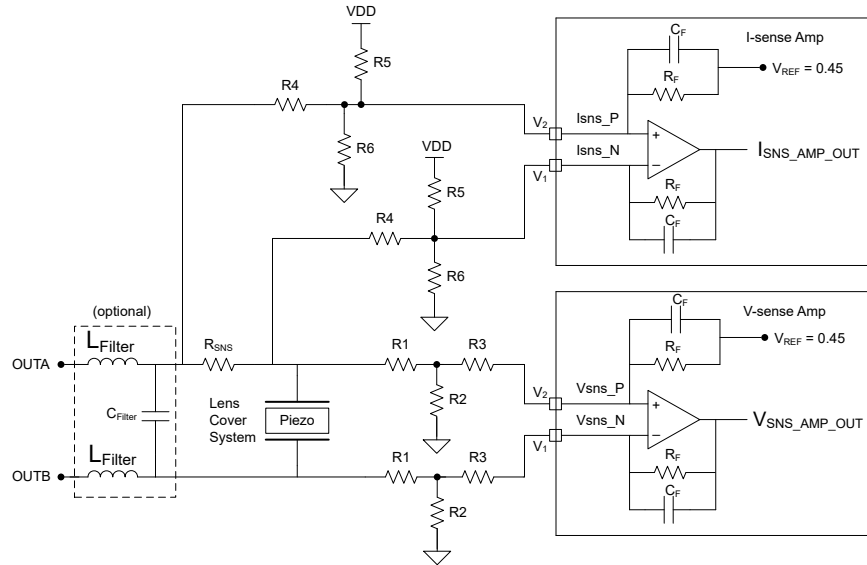

Figure 5-9. Voltage and Current Sense Amplifiers

$$USER_Params_ohms_sf_Q22 = \frac{ISNS_GAIN}{VSNS_GAIN} \tag{2}$$

$$USER_Params_watts_sf_Q18 = \frac{1}{VSNS_GAIN} \times \frac{1}{ISNS_GAIN} \times 0.2025 \tag{3}$$

$$USER_Params_Imag_max_sf_Q27 = \frac{0.9}{ISNS_GAIN} \tag{4}$$

$$ISNS_GAIN \left(\frac{V}{A} \right) = \frac{R_f \times R_{SNS}}{R_4} \tag{5}$$

$$VSNS_GAIN \left(\frac{V}{V} \right) = 1.043 \times \frac{R_f}{R_1 \times R_3 \times \left(\frac{1}{R_1} + \frac{1}{R_2} + \frac{1}{R_3} \right)} \tag{6}$$

Table 5-6. Voltage and Current Sense Resistor Reference Values

R5 = 6k Ω . R6 = 2k Ω

Differential Voltage (pk-pk)	R1	R2	R3	R4
460	1.3M Ω	6.34k Ω	294k Ω	422k Ω
90	360k Ω	30k Ω	1M Ω	150k Ω
40	150k Ω	30k Ω	1M Ω	150k Ω

5.2.3 Cleaning Mode Settings

Texas Instruments created four main cleaning modes for removing ice, mud, and water from the lens of the LCS. The GUI allows select settings to be adjusted for these cleaning modes and also gives the user freedom to create two custom cleaning modes.

As mentioned in [Section 4](#), there are nine modes that can contain up to 30 configurable bursts. Each burst is played in the order the burst is programmed and the #Bursts setting must be set correctly to play the number of desired bursts. The #Burst register is USER_Params_numBurstsPerMode_x, where x equals 0 through 9. The mode sequences are enumerated with registers using the following syntax, USER_Params_modeSequence_n_m, where n equals the mode number (0-9) and m equals the burst sequence order (0-29). There are up to 30 bursts maximum per mode. The following sections show Texas Instruments' predefined bursts.

Any cleaning mode, excluding Auto mode, can be run continuously by checking the *Continuous Mode* check box located in the top right corner above the burst 29 column name. When a mode is running continuously, *un-check the Continuous Mode* checkbox to put the ULC1001 back into Single Mode; the mode runs one additional time and then stops.

Note

Do not check the Continuous Mode check box and the Continuous Auto Mode check box when running Auto Mode. See [Section 5.2.3.1](#).

The additional parameters on the Cleaning Modes page are shown in [Figure 5-10](#) and described in [Table 5-7](#) and [Table 5-8](#).

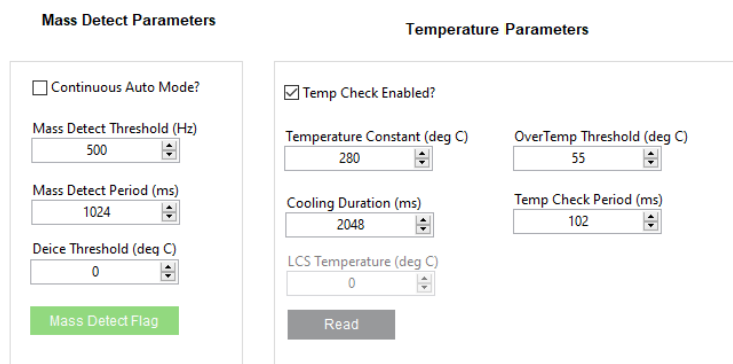

The screenshot shows two panels of settings. The left panel, titled 'Mass Detect Parameters', includes a 'Continuous Auto Mode?' checkbox (unchecked), a 'Mass Detect Threshold (Hz)' spinner set to 500, a 'Mass Detect Period (ms)' spinner set to 1024, and a 'Deice Threshold (deg C)' spinner set to 0. A green 'Mass Detect Flag' button is at the bottom. The right panel, titled 'Temperature Parameters', includes a 'Temp Check Enabled?' checkbox (checked), a 'Temperature Constant (deg C)' spinner set to 280, an 'OverTemp Threshold (deg C)' spinner set to 55, a 'Cooling Duration (ms)' spinner set to 2048, a 'Temp Check Period (ms)' spinner set to 102, and an 'LCS Temperature (deg C)' spinner set to 0. A grey 'Read' button is at the bottom.

Figure 5-10. Cleaning Mode Settings

Table 5-7. Mass Detect Parameters

Parameter	Description
Continuous Auto Mode? Check Box	Enables the Auto mode to run automatically without setting the USER_Commands_flag_newCommand at the specified period when the device is in the active power mode. PWR_CTL = 0x00.
Mass Detect Threshold	Frequency impedance threshold that controls how sensitive the system is to contaminants on the LCS.
Mass Detect Period	Time interval used when Continuous Auto mode is enabled.
Deice Threshold	Temperature threshold to activate deice in Auto mode sequence.

Table 5-8. Temperature Parameters

Parameter	Description
Continuous Temp? Check Box	This check box controls how the temperature algorithm is run. When checked, the temperature burst runs based on the Temp Check Period and interrupts any passive burst to check the LCS temperature, then returns to the burst being played. When enabled, the temperature burst is also run at the beginning of any mode
Temperature Constant [°C]	LCS temperature estimation algorithm constant auto updated by Calibration Mode.
OverTemp Threshold [°C]	LCS Temperature threshold at which the ULC1001 flags an Over Temperature condition.
Cooling Duration [sec]	Cooling time provided by ULC1001 to LCS in the event of an Over Temperature condition.
Temp Check Period [sec]	Time period between temperature checks in continuous mode.

5.2.3.1 Auto-Cleaning

Texas Instruments proprietary Auto Cleaning Mode is composed of five bursts, enumerated bursts (19, 8, 9, 13, 14). Auto-Cleaning mode utilizes Texas Instruments' mass detection algorithm to invoke the cleaning algorithm. The settings for enumerated bursts (8, 9, 13, 14) are the same as those used in Water Mode. The burst parameters for enumerated burst (19) must be set according to [Section 4.3.3](#) and [Table 5-2](#). This burst must not be directly updated by the user in the GUI. Rather, the burst is auto-updated by setting up and running the calibration mode. The Temp burst (23) can also be added to the Auto Cleaning Mode integrate auto de-icing capabilities. An example de-icing sequence is (19, 23, 16 or 17, 8, 9, 13, 14). If mass is detected on the lens by burst 19 and burst 23 determines the LCS temperature is below the threshold, USER_Params_Deice_TempThreshold_C_Q21, the heating burst (16 or 17) is executed and followed by the remaining water bursts (8, 9, 13, 14). If mass is detected on the LCS by burst 19 and burst 23 determines the LCS temperature is above the threshold, USER_Params_Deice_TempThreshold_C_Q21, the next burst, typically a heating burst, is skipped and the remaining water bursts execute. If burst 19 determines there is no mass on the lens, then all following bursts do not execute.

Note

Auto Cleaning Mode can be run continuously by checking Continuous Auto Mode check box located in the Mass Detect Parameters section. Requires device to be in Active mode (PWR_CTL = 0x00) and initialized.

5.2.3.2 Water Cleaning

Texas Instruments proprietary Water Cleaning Mode is composed of 4 bursts, enumerated bursts (8, 9, 13, 14). The first two bursts (8 and 9) utilize cleaning for one frequency region while the second two bursts (13 and 14) clean at a second frequency region. These bursts are setup by running [Section 4.3.4](#). For single-mode systems with only one frequency region of interest, this mode can be configured to enumerated bursts (8, 9, 10, 11) or (12, 13, 14, 15). The flexible GUI allows users to modify the water mode for best cleaning performance.

5.2.3.3 Deice Cleaning

Texas Instruments proprietary Deice Mode is composed of five bursts, which are enumerated bursts (16, 8, 9, 13, 14). The settings for the enumerated bursts (8, 9, 13, 14) are the same as those used in Water Mode. The additional burst (16) is a heating mode used to heat the transducer. The additional burst (16) can be interchanged with burst 17 or programmed manually depending on the heating region. The duration of the heat burst can be adjusted as needed. These bursts are set up by running [Section 4.3.4](#). Understanding the rate at which the LCS heats up and setting the temperature protection setting appropriately is important. TI recommends enabling Continuous Temperature protection when running the Deice Mode.

5.2.3.4 Mud Cleaning Mode

Texas Instruments proprietary Mud Cleaning Mode is composed of 25 bursts. The method for removing mud from the lens consists of two sets of water cleaning bursts, one heating burst, and then four more water cleaning bursts. These burst can be adjusted based on the LCS. The concept is that the initial water bursts remove water from the mud mixture, then heat the mud into a dry state, and finally expel the dry mud contaminants. The duration of the heat burst can be adjusted as needed. These bursts are setup by running [Section 4.3.4](#). Understanding the rate at which the LCS heats up and setting the temperature protection setting appropriately is important. TI recommends enabling Continuous Temperature protection when running the Mud Cleaning Mode.

5.2.4 Power and Diagnostic Settings

Texas Instruments created two additional modes to regulate the power delivered to the LCS, identify the faults of LCS, and check for an open load condition on the output. Refer to [Section 4.5](#) for more details on the diagnostic modes.

The Power mode consists of two bursts (20 and 21). Burst 20 corresponds to Power Region 1, which is calibrated using Cal Region 1. Burst 21 corresponds to Power Region 2, which is calibrated using Cal Region 2. For convenience, the calibrated power values appear in the Power Parameters section of the GUI shown on the right side of [Figure 5-11](#). The remaining settings are described in the [Table 5-9](#).

The System Fault mode is a single burst which corresponds to Cal Region System Fault. The settings available for this mode are shown on the left side of [Figure 5-11](#) and described in the [Table 5-10](#).

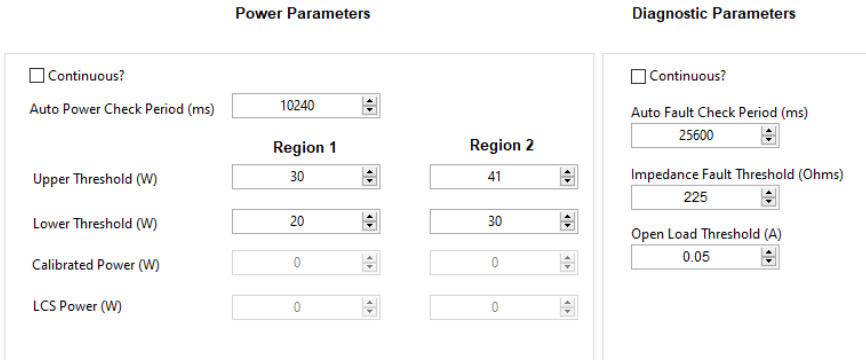

The screenshot shows two panels: 'Power Parameters' and 'Diagnostic Parameters'. Each panel has a 'Continuous?' checkbox. The 'Power Parameters' panel includes an 'Auto Power Check Period (ms)' set to 10240, and two columns for 'Region 1' and 'Region 2' with 'Upper Threshold (W)', 'Lower Threshold (W)', 'Calibrated Power (W)', and 'LCS Power (W)' settings. The 'Diagnostic Parameters' panel includes an 'Auto Fault Check Period (ms)' set to 25600, and 'Impedance Fault Threshold (Ohms)' set to 225, and 'Open Load Threshold (A)' set to 0.05.

Figure 5-11. Power and Diagnostic Settings

Table 5-9. Power Parameters

Parameter	Description
Continuous? Check Box	Enables continuous power checks to run automatically without setting the USER_Commands_flag_newCommand at the specified period when the device is in the active power mode. PWR_CTL = 0x00
Auto Power Check Period	Time interval used when Continuous Power mode is enabled
Region 1 Upper Threshold	Upper power threshold for Region 1
Region 1 Lower Threshold	Lower power threshold for Region 1
Region 2 Upper Threshold	Upper power threshold for Region 2
Region 2 Lower Threshold	Lower power threshold for Region 2

Table 5-10. Diagnostic Parameters

Parameter	Description
Continuous? Check Box	Enables continuous diagnostic checks to run automatically without setting the USER_Commands_flag_newCommand at the specified period when the device is in the active power mode. PWR_CTL = 0x00.
Auto Fault Check Period	Time interval used when Continuous Diagnostic mode is enabled.
Impedance Fault Threshold	Threshold for determining a fault in the LCS.
Open Load Threshold	Current threshold for detecting an open load condition.

5.3 Register Map Page

The Register Map Page lists the ULC1001 Registers and the details in a spreadsheet view. Figure 5-12 shows an example of the Hardware Register and Figure 5-13 shows an example of the Firmware Register in the GUI. Clicking on a register shows the different fields on the right. Moving the mouse over a field highlights the corresponding bits in the tree. The value of a register can be set in one of the following three ways:

1. Double-clicking and entering a hex value in *Value* column.
2. Single-clicking on any bit to toggle between 0 and 1.
3. Changing the field value in the Field View.

The Field Value and Register Value, which is actually set to the device, do not match due to the scale factors that are automatically applied in the GUI back end. Certain Registers are related, such as the registers corresponding to the burst parameters in the high level page. When a Register value is updated in the Register Map Page, the dependent registers, if any, are also updated.

Note

Not all parameter optimization functions, such as value bounding and rounding functions, performed to the high level page fields are performed in the Register Map Page. For any register written in the Register Map Page, these registers do not have the values optimized until the user switches back to the High Level Page.

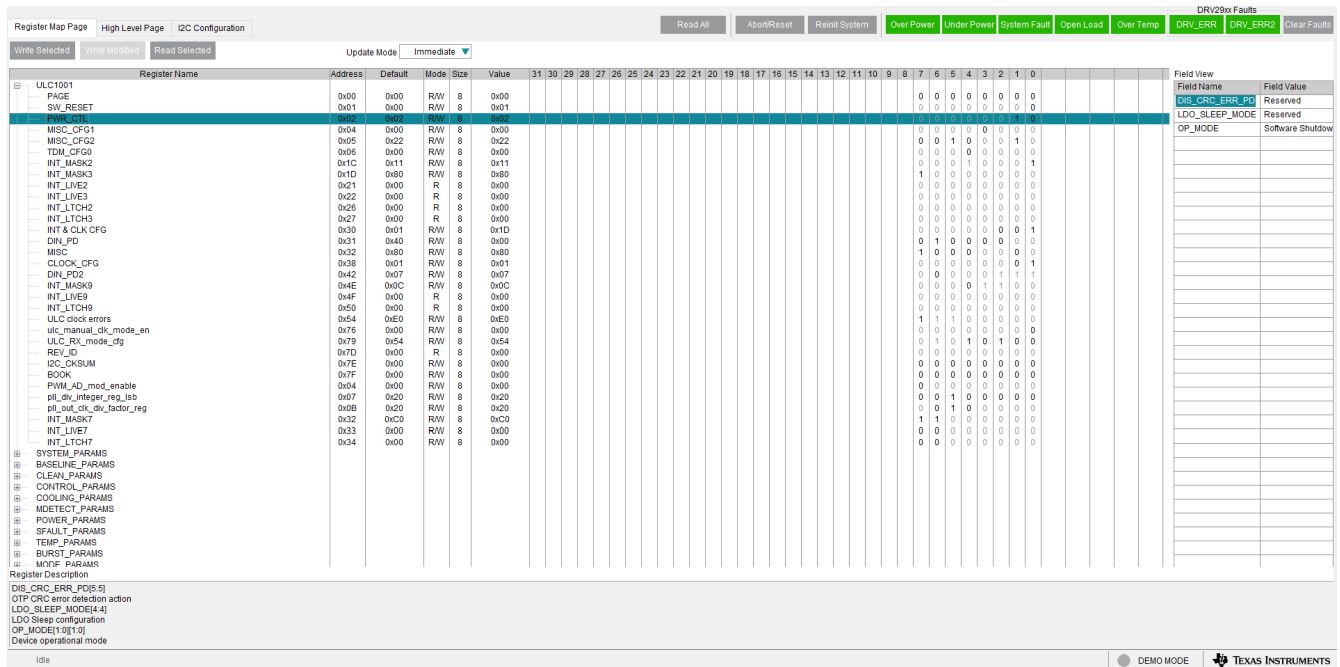

The screenshot displays the Register Map Page for the ULC1001. It features a top navigation bar with tabs for 'Register Map Page', 'High Level Page', and 'I2C Configuration'. Below this is a toolbar with buttons for 'Read All', 'About/Reset', 'Reinit System', 'Over Power', 'Under Power', 'System Fault', 'Open Load', 'Over Temp', 'DRV_ERR', 'DRV_ERR2', and 'Clear Faults'. The main area is a spreadsheet-like table with columns for 'Register Name', 'Address', 'Default', 'Mode', 'Size', and 'Value'. The 'Value' column is expanded to show individual bits from 31 down to 0. A 'Field View' panel on the right shows the bit fields for the selected register, with 'Field Name' and 'Field Value' columns. The bottom of the screen shows a status bar with 'Idle', 'DEMO MODE', and the Texas Instruments logo.

Register Name	Address	Default	Mode	Size	Value
ULC1001					
PAGE	0x00	0x00	R/W	8	0x00
SW_RESET	0x01	0x00	R/W	8	0x01
MISC_CFG1	0x04	0x00	R/W	8	0x00
MISC_CFG2	0x05	0x22	R/W	8	0x22
TDM_CFG0	0x06	0x00	R/W	8	0x00
INT_MASK2	0x1C	0x11	R/W	8	0x11
INT_MASK3	0x1D	0x80	R/W	8	0x80
INT_LIVE2	0x21	0x00	R	8	0x00
INT_LIVE3	0x22	0x00	R	8	0x00
INT_LTCH2	0x26	0x00	R	8	0x00
INT_LTCH3	0x27	0x00	R	8	0x00
INT & CLK_CFG	0x30	0x01	R/W	8	0x01
DIN_PD	0x31	0x40	R/W	8	0x40
MISC	0x32	0x80	R/W	8	0x80
CLOCK_CFG	0x38	0x01	R/W	8	0x01
DIN_PD2	0x42	0x07	R/W	8	0x07
INT_MASK9	0x4E	0x0C	R/W	8	0x0C
INT_LIVE9	0x4F	0x00	R	8	0x00
INT_LTCH9	0x50	0x00	R	8	0x00
ULC dock errors	0x54	0xE0	R/W	8	0xE0
ulc_manual_dk_mode_en	0x76	0x00	R/W	8	0x00
ULC_RX_mode_dfg	0x79	0x54	R/W	8	0x54
REV_ID	0x7D	0x00	R	8	0x00
I2C_CHKSUM	0x7E	0x00	R/W	8	0x00
BQOK	0x7F	0x00	R/W	8	0x00
PWM_AD_mod_enable	0x04	0x00	R/W	8	0x00
pll_div_integer_reg_lsb	0x07	0x20	R/W	8	0x20
pll_out_div_div_factor_reg	0x0B	0x20	R/W	8	0x20
INT_MASK7	0x32	0xC0	R/W	8	0xC0
INT_LIVE7	0x33	0x00	R/W	8	0x00
INT_LTCH7	0x34	0x00	R/W	8	0x00

Figure 5-12. GUI Register Map Page (Hardware Register)

Register Map Page										High Level Page										I2C Configuration										Read All										Abort/Reset										Reinit System										Over Power										Under Power										System Fault										Open Load										Over Temp										DRV290x Faults									
Write Selected										Write Modes										Read Selected										Update Mode										Immediate																																																																															
Register Name	Address	Default	Mode	Size	Value	31	30	29	28	27	26	25	24	23	22	21	20	19	18	17	16	15	14	13	12	11	10	9	8	7	6	5	4	3	2	1	0	Field Name	Field Value																																																																																
ULC1001																																																																																																																							
SYSTEM_PARAMS																																																																																																																							
USER_Params_pwmClcOfFreq_Hz	0x0C	0x2FAF0800	RW	32	0x2FAF0800	0	0	1	0	1	1	1	1	1	0	1	0	1	1	1	1	0	0	0	0	0	0	1	0	0	0	0	0	0	0	0	0	USER_Params_num	512																																																																																
USER_Params_voltsPerCht_sf	0x10	0x00000000	RW	32	0x00000000	0	0	0	0	0	0	0	0	0	0	0	0	0	0	0	0	0	0	0	0	0	0	0	0	0	0	0	0	0	0	0																																																																																			
USER_Params_ampsPerCht_sf	0x14	0x00000000	RW	32	0x00000000	0	0	0	0	0	0	0	0	0	0	0	0	0	0	0	0	0	0	0	0	0	0	0	0	0	0	0	0	0	0	0																																																																																			
USER_Params_senseBias_Q27	0x18	0x00000000	RW	32	0x00000000	0	0	0	1	0	0	0	0	0	0	0	0	0	0	0	0	0	0	0	0	0	0	0	0	0	0	0	0	0	0	0																																																																																			
USER_Params_senseBias_Q25	0x1C	0x02000000	RW	32	0x02000000	0	0	0	0	0	1	0	0	0	0	0	0	0	0	0	0	0	0	0	0	0	0	0	0	0	0	0	0	0	0	0																																																																																			
USER_Params_fir_Hz_Q9	0x20	0x0F424000	R	32	0x0F424000	0	0	0	0	1	1	1	1	1	0	0	0	0	1	0	0	0	1	0	0	0	0	0	0	0	0	0	0	0	0	0	0																																																																																		
USER_Params_fir_Hz_Q9	0x24	0x0007A120	R	32	0x0007A120	0	0	0	0	0	0	0	0	0	0	0	0	0	1	1	1	1	1	0	0	0	0	0	0	0	0	0	0	0	0	0																																																																																			
USER_Params_numSamples	0x28	0x00000000	RW	32	0x00000000	0	0	0	0	0	0	0	0	0	0	0	0	0	0	0	0	0	0	0	0	0	0	0	0	0	0	0	0	0	0	0																																																																																			
USER_Params_delay_usec	0x2C	0x00000000	R	32	0x00000000	0	0	0	0	0	0	0	0	0	0	0	0	0	0	0	0	0	0	0	0	0	0	0	0	0	0	0	0	0	0	0																																																																																			
USER_Params_Vdelay_usec	0x30	0x00000000	R	32	0x00000000	0	0	0	0	0	0	0	0	0	0	0	0	0	0	0	0	0	0	0	0	0	0	0	0	0	0	0	0	0	0	0																																																																																			
USER_Params_delayRatio_U_Q30	0x34	0x00000000	R	32	0x00000000	0	0	0	0	0	0	0	0	0	0	0	0	0	0	0	0	0	0	0	0	0	0	0	0	0	0	0	0	0	0	0																																																																																			
USER_Params_delayRatio_V_Q30	0x38	0x00000000	R	32	0x00000000	0	0	0	0	0	0	0	0	0	0	0	0	0	0	0	0	0	0	0	0	0	0	0	0	0	0	0	0	0	0	0																																																																																			
USER_Params_dcBiasParams_fmCoef_U_Q24_0	0x40	0x000082F1	RW	32	0x000082F1	0	0	0	0	0	0	0	0	0	0	0	0	0	0	0	0	0	0	0	0	0	0	1	0	0	0	1	1	1	1	0																																																																																			
USER_Params_dcBiasParams_fmCoef_U_Q24_1	0x44	0x00000000	RW	32	0x00000000	0	0	0	0	0	0	0	0	0	0	0	0	0	0	0	0	0	0	0	0	0	0	0	0	0	0	0	0	0	0	0																																																																																			
USER_Params_dcBiasParams_fmCoef_U_Q24_2	0x48	0x00000000	RW	32	0x00000000	0	0	0	0	0	0	0	0	0	0	0	0	0	0	0	0	0	0	0	0	0	0	0	0	0	0	0	0	0	0	0																																																																																			
USER_Params_dcBiasParams_fmCoef_U_Q24_3	0x4C	0x007FBE88	RW	32	0x007FBE88	0	0	0	0	0	0	0	0	0	0	1	1	1	1	1	1	1	1	1	1	1	1	1	1	0	0	0	0	0	0	0																																																																																			
USER_Params_dcBiasParams_fmCoef_U_Q24_4	0x50	0x00000000	RW	32	0x00000000	0	0	0	0	0	0	0	0	0	0	0	0	0	0	0	0	0	0	0	0	0	0	0	0	0	0	0	0	0	0	0																																																																																			
USER_Params_dcBiasParams_fmCoef_V_Q24_0	0x54	0x000082F1	RW	32	0x000082F1	0	0	0	0	0	0	0	0	0	0	0	0	0	0	0	0	0	0	0	0	0	0	1	0	0	0	1	1	1	1	0																																																																																			
USER_Params_dcBiasParams_fmCoef_V_Q24_1	0x58	0x00000000	RW	32	0x00000000	0	0	0	0	0	0	0	0	0	0	0	0	0	0	0	0	0	0	0	0	0	0	0	0	0	0	0	0	0	0	0																																																																																			
USER_Params_dcBiasParams_fmCoef_V_Q24_2	0x5C	0x00000000	RW	32	0x00000000	0	0	0	0	0	0	0	0	0	0	0	0	0	0	0	0	0	0	0	0	0	0	0	0	0	0	0	0	0	0	0																																																																																			
USER_Params_dcBiasParams_fmCoef_V_Q24_3	0x60	0x007FBE88	RW	32	0x007FBE88	0	0	0	0	0	0	0	0	0	0	1	1	1	1	1	1	1	1	1	1	1	1	1	1	0	0	0	0	0	0	0																																																																																			
USER_Params_dcBiasParams_fmCoef_V_Q24_4	0x64	0x00000000	RW	32	0x00000000	0	0	0	0	0	0	0	0	0	0	0	0	0	0	0	0	0	0	0	0	0	0	0	0	0	0	0	0	0	0	0																																																																																			
USER_Params_dcBiasParams_amps_sf_Q28	0x68	0x10000000	RW	32	0x10000000	0	0	1	0	0	0	0	0	0	0	0	0	0	0	0	0	0	0	0	0	0	0	0	0	0	0	0	0	0	0	0																																																																																			
USER_Params_dcBiasParams_volts_sf_Q30	0x6C	0x00000000	RW	32	0x00000000	0	0	0	0	0	0	0	0	0	0	0	0	0	0	0	0	0	0	0	0	0	0	0	0	0	0	0	0	0	0	0																																																																																			
USER_Params_dcBiasParams_numSamples	0x70	0x00000200	RW	32	0x00000200	0	0	0	0	0	0	0	0	0	0	0	0	0	0	0	0	0	0	0	0	0	0	1	0	0	0	0	0	0	0	0																																																																																			
USER_Params_dcBiasParams_log2NumSamples	0x74	0x00000000	RW	32	0x00000000	0	0	0	0	0	0	0	0	0	0	0	0	0	0	0	0	0	0	0	0	0	0	0	0	0	0	0	0	0	0	0																																																																																			
USER_Params_dcBiasParams_numStages	0x78	0x00000010	RW	32	0x00000010	0	0	0	0	0	0	0	0	0	0	0	0	0	0	0	0	0	0	0	0	0	0	0	0	0	0	0	0	0	0	0																																																																																			
USER_Params_oneOverWindow_sf	0x7C	0x00000000	RW	32	0x00000000	0	0	0	0	0	0	0	0	0	0	0	0	0	0	0	0	0	0	0	0	0	0	0	0	0	0	0	0	0	0	0																																																																																			
USER_Params_amps_sf_Q28	0x80	0x10000000	RW	32	0x10000000	0	0	1	0	0	0	0	0	0	0	0	0	0	0	0	0	0	0	0	0	0	0	0	0	0	0	0	0	0	0	0																																																																																			
USER_Params_volts_sf_Q30	0x84	0x00000000	RW	32	0x00000000	0	0	0	0	0	0	0	0	0	0	0	0	0	0	0	0	0	0	0	0	0	0	0	0	0	0	0	0	0	0	0																																																																																			
USER_Params_wait_sf_Q18	0x88	0x00000000	RW	32	0x00000000	0	0	0	0	0	0	0	0	0	0	0	0	0	0	0	0	0	0	0	0	0	0	0	0	0	0	0	0	0	0	0																																																																																			
USER_Params_fmFir_kick_Q31	0x8C	0x000047C8	R	32	0x000047C8	0	0	0	0	0	0	0	0	0	0	0	0	0	0	0	0	0	0	0	0	0	1	1	0	0	1	1	1	1	0	0																																																																																			
USER_Params_log2NumSamples	0x90	0x00000009	R	32	0x00000009	0	0	0	0	0	0	0	0	0	0	0	0	0	0	0	0	0	0	0	0	0	0	0	0	0	0	0	0	0	0	0																																																																																			
USER_Params_blockSize	0x94	0x00000020	R	32	0x00000020	0	0	0	0	0	0	0	0	0	0	0	0	0	0	0	0	0	0	0	0	0	0	0	0	0	0	0	0	0	0	0																																																																																			
USER_Params_numStages	0x98	0x00000001	RW	32	0x00000001	0	0	0	0	0	0	0	0	0	0	0	0	0	0	0	0	0	0	0	0	0	0	0	0	0	0	0	0	0	0	0																																																																																			
USER_Params_log2BlockSize	0x9C	0x00000009	R	32	0x00000009	0	0	0	0	0	0	0	0	0	0	0	0	0	0	0	0	0	0	0	0	0	0	0	0	0	0	0	0	0	0	0																																																																																			
USER_Params_modulation_AD_samplesPerPeriod	0xA0	0x0000000A	R	32	0x0000000A	0	0	0	0	0	0	0	0	0	0	0	0	0	0	0	0	0	0	0	0	0	0	0	0	0	0	0	0	0	0	0																																																																																			
USER_Params_imga_msa_sf_Q27	0xA4	0x2428E28E	RW	32	0x2428E28E	0	1	0	1	0	0	0	1	0	0	1	0	1	1	1	1	1	1	0	0	1	0	0	1	0	1	1	1	1	1	0																																																																																			
USER_Params_imgb_wlkr_sf_Q31	0xA8	0x0028F5C2	R	32	0x0028F5C2	0	0	0	0	0	0	0	0	0	0	0	1	0	1	0	0	0	1	1	1	1	1	0	1	0	1	0	0	0	0	0																																																																																			
USER_Params_Daize_TamperThreshold C_Q21	0xB0	0x00000000	RW	32	0x00000000	0	0	0	0	0	0	0	0	0	0	0	0	0	0	0	0	0	0	0	0	0	0	0	0	0	0	0	0	0	0	0																																																																																			

Figure 5-13. GUI Register Map Page (Software Registers)

Note

Register USER_Params_numSamples has no Q-point notation. Whereas register USER_Params_fir_Hz_Q9 has a Q9 notation. For example, 976.5625 in Q9 notation can be calculated using the formula $976.5625 \times 2^9 = 500000$. Then convert 500000 to binary 32-bit value.

5.4 I²C Configuration Page

The I²C Configuration Page in [Figure 5-14](#) supports writing raw values to the device directly by specifying the Book Address, Page Address, and Register Address. Since the ULC1001 device has both 8-bit and 32-bit Registers, mentioning how many bytes to read while doing a read operation is necessary.

Note

Any change done from this page is not reflected in the other pages. The user has to press the *Read All* button in the North Pane to display the current values in the other pages.

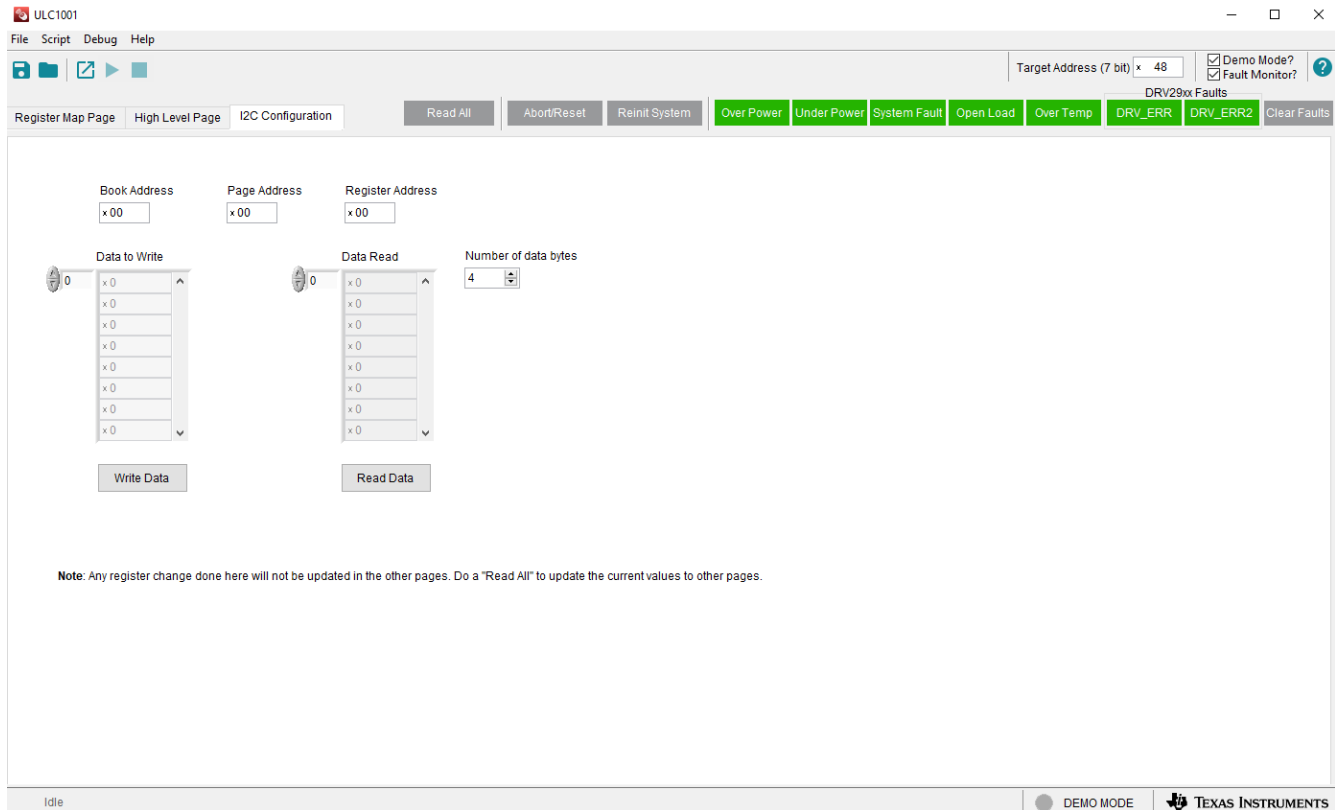

Figure 5-14. I²C Configuration

5.5 GUI Functions

5.5.1 Monitor Communication Status

The GUI status bar is located in the South Pane shown in [Figure 5-15](#). The status bar allows communication status to be monitored. The communication mode health indicator at the bottom right is lit yellow when not connected, lit green when connected, or unlit when in demo mode. When first opened, the GUI automatically attempts to connect with the ULC1001-DRV290x EVM via the USB2ANY interface. Upon successful connection, the green lit *connected* indicator appears as in the bottom right corner of the status bar. This connection takes approximately 25 seconds. Communication issues can include a faulty USB2ANY interface connection, an incorrect target address, or an incomplete GUI initialization. The *Read/Write Status Indicator* on the bottom left of the status bar cycles quickly through register names when the GUI is reading or writing registers from the ULC1001-DRV290x EVM. Double clicking the *Read/Write Status Indicator* on the status bar opens a floating window which displays the entire status log, shown in [Figure 5-16](#). Right-clicking this floating window shows the options to clear log or save the log or set the size. The status log is meant for recording Register Read/Write sequences. To create register read/write scripts, see [Section 5.5.9](#).



Figure 5-15. GUI Status Bar

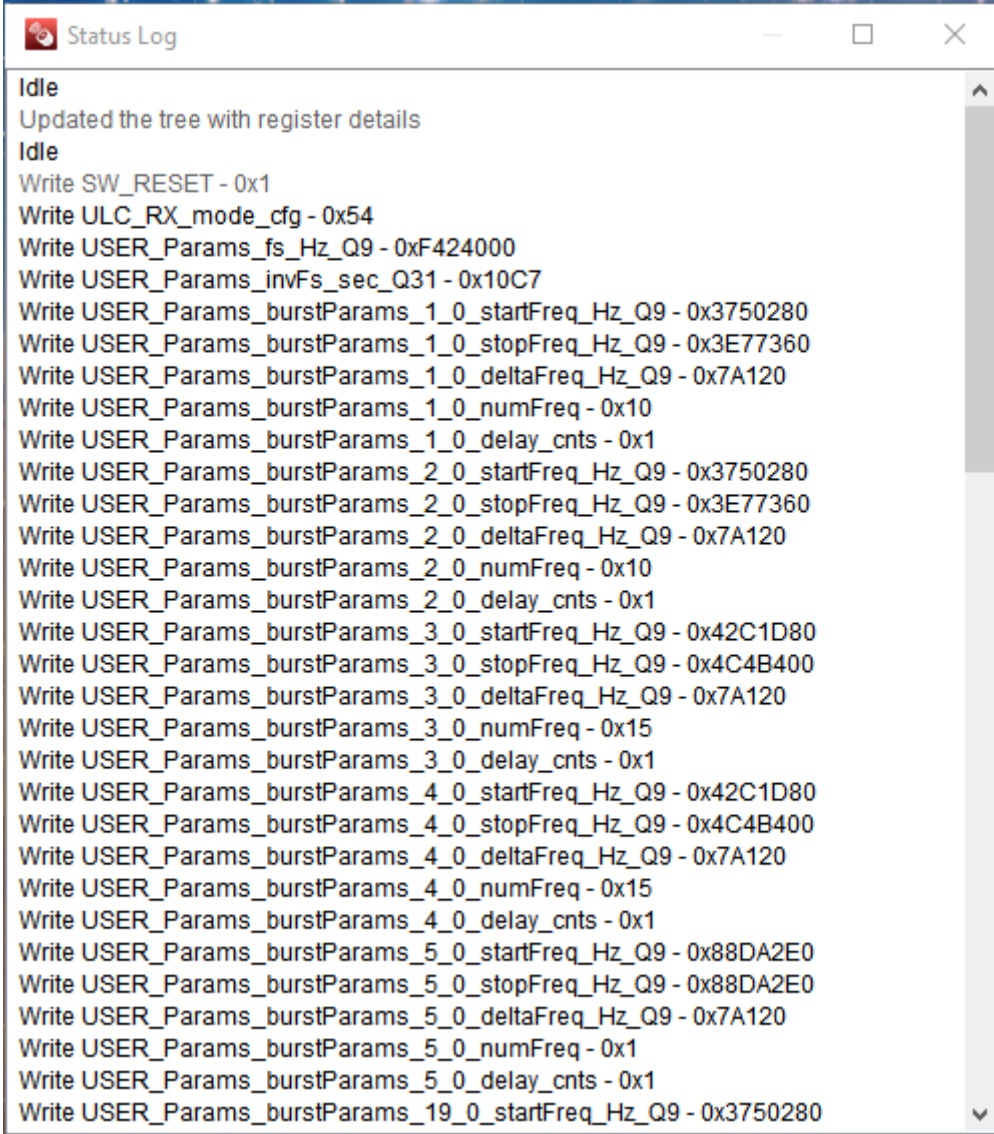

```

Status Log
Idle
Updated the tree with register details
Idle
Write SW_RESET - 0x1
Write ULC_RX_mode_cfg - 0x54
Write USER_Params_fs_Hz_Q9 - 0xF424000
Write USER_Params_invFs_sec_Q31 - 0x10C7
Write USER_Params_burstParams_1_0_startFreq_Hz_Q9 - 0x3750280
Write USER_Params_burstParams_1_0_stopFreq_Hz_Q9 - 0x3E77360
Write USER_Params_burstParams_1_0_deltaFreq_Hz_Q9 - 0x7A120
Write USER_Params_burstParams_1_0_numFreq - 0x10
Write USER_Params_burstParams_1_0_delay_cnts - 0x1
Write USER_Params_burstParams_2_0_startFreq_Hz_Q9 - 0x3750280
Write USER_Params_burstParams_2_0_stopFreq_Hz_Q9 - 0x3E77360
Write USER_Params_burstParams_2_0_deltaFreq_Hz_Q9 - 0x7A120
Write USER_Params_burstParams_2_0_numFreq - 0x10
Write USER_Params_burstParams_2_0_delay_cnts - 0x1
Write USER_Params_burstParams_3_0_startFreq_Hz_Q9 - 0x42C1D80
Write USER_Params_burstParams_3_0_stopFreq_Hz_Q9 - 0x4C4B400
Write USER_Params_burstParams_3_0_deltaFreq_Hz_Q9 - 0x7A120
Write USER_Params_burstParams_3_0_numFreq - 0x15
Write USER_Params_burstParams_3_0_delay_cnts - 0x1
Write USER_Params_burstParams_4_0_startFreq_Hz_Q9 - 0x42C1D80
Write USER_Params_burstParams_4_0_stopFreq_Hz_Q9 - 0x4C4B400
Write USER_Params_burstParams_4_0_deltaFreq_Hz_Q9 - 0x7A120
Write USER_Params_burstParams_4_0_numFreq - 0x15
Write USER_Params_burstParams_4_0_delay_cnts - 0x1
Write USER_Params_burstParams_5_0_startFreq_Hz_Q9 - 0x88DA2E0
Write USER_Params_burstParams_5_0_stopFreq_Hz_Q9 - 0x88DA2E0
Write USER_Params_burstParams_5_0_deltaFreq_Hz_Q9 - 0x7A120
Write USER_Params_burstParams_5_0_numFreq - 0x1
Write USER_Params_burstParams_5_0_delay_cnts - 0x1
Write USER_Params_burstParams_19_0_startFreq_Hz_Q9 - 0x3750280

```

Figure 5-16. GUI Status Log

5.5.2 Load and Save Configuration Files

The GUI Register Values can be saved to a configuration file for later use. The configuration file saves the GUI and ULC1001 register map state. With this feature, Calibration Mode can be skipped if the GUI configuration is saved just after Calibration Mode has been run, and a configuration file with calibrated files is loaded. Additionally, a configuration header file can be saved for end system integration.

To open and save configuration files, use the File Menu in the Menu Bar or the **Save** and **Open** buttons in the Tools Bar of the North Pane shown in [Figure 5-2](#). After a Calibration File is opened, the GUI can take up to a minute to complete the register updates. A complete load of the configuration file is completed when the *Read/Write Status Indicator* of the Status Bar displays *Idle*. The *Reinit System* button in the North Pane must be selected so that the ULC1001 re-initializes the internal variables with the register values written to its I²C buffer.

The header file can be used to modify the on-board MSP430 software use with the push buttons. This modification is done in the File menu by clicking on File-Save Configuration to Header File. There is an additional EEPROM chip on the EVM that holds part of the ULC1001 header file, specifically the PRAM. The entire header file, including the PRAM, is 46 kb. For new designs, TI recommends to use a microcontroller that can hold the entire header file. In this case, the EEPROM chip is not necessary.

5.5.2.1 MSP430 Firmware Programming

An on-board MSP430 gives users the capability of using push button controls for running calibration and cleaning modes. The MSP430 can automatically load a configuration file to the ULC1001 device. To modify the firmware for the specific LCS being used, follow these instructions:

1. Download and install CCS. CCS version 12 was used for the initial firmware development.
2. Create a CCS Workspace or use an existing Workspace.
3. Create a new empty project by selecting *Project - New CCS Project*.
 - a. The Target device is *MSP430F5510*.
 - b. Project Name is *ulc-pram*.
 - c. Select *Empty Project*.
4. Create a new empty project by selecting *Project - New CCS Project*.
 - a. The Target device is *MSP430F5510*.
 - b. Project Name is *ulc-demo*.
 - c. Select *Empty Project*.
5. Download the two project files from TI.com (ulc-pram and ulc-demo).
6. For each project, copy the below folder / documents from the downloaded project to the respective CCS project directory.
 - a. firmware-source
 - b. .ccsproject
 - c. .cproject
 - d. .project
 - e. lnk_msp430f5510
7. Save the configuration header file in the GUI. Refer to [Section 5.5.2](#).
8. Turn on the EVM.
9. Rename the header file *ulc_gui_header_default_no_PRAM.h*, and replace the header file in the ulc-demo CCS project located at *\\firmware-source\register_setting*.
10. Compile and load the ulc-pram firmware using the MSP-FET Flash Emulation Tool II. Or compile the project and use the .out file in the UniFlash stand-alone flash tool. This firmware loads the PRAM files into the onboard EEPROM. Power cycle the EVM.
11. Compile and load the ulc-demo firmware using the MSP-FET Flash Emulation Tool II. Or compile the project and use the .out file in the UniFlash stand-alone flash tool. This is the main firmware that controls and communicates ULC1001.

To connect the MSP-FET tool to the EVM, use pins 3-5 of header J3, which are SBWTDIO, SBWTCK, and GND. These pins map to the MSP-FET tool as follows:

- SBWTDIO: J3-pin 3 goes to MSP-FET pin 1.
- SBWTCK: J3-pin 4 goes to MSP-FET pin 7.
- GND: J3-pin 5 goes to MSP-FET pin 9.

5.5.3 Re-initialize System

The *Reinit System* button in the North Pane commands the ULC1001 to initialize the new parameters that are changed in the GUI. Clicking on the *Reinit System* button is not required when pushing the Run Button located on the far right side of each mode. When a parameter is changed in the GUI, the command is sent to the system. However, these commands are not updated until the *Reinit System* button is pressed. Once pressed, the system first re-initializes with any new settings, performs a read all from the ULC1001, and updates all of the GUI settings based on the ULC1001 settings.

The register sequence for Reinit is displayed in [Table 5-11](#).

Table 5-11. Reinit Mode Sequence

Register	Read/Write	Data	Description
00	W	00	Change to Page 0
7F	W	00	Change to Book 0
02	W	00	Put device in active mode.
NA	NA	NA	Wait 5ms
00	W	1A	Change to page 0x1A
58	W	0000000E	Set Reinit Command in the UserCommand Register
5C	W	00000001	Tells device there is a new command to be executed.
NA	NA	NA	Wait until above register, 0x5C, = 0. (5ms).
00	W	00	Change to page 0
02	W	02	Put device in software shutdown mode

In the GUI, the following script can be used in the Python window to Re-initialize the system.

```

GUI_Module=__import__('ULC1001')

import time #import time for delays

GUI=GUI_Module.Device_GUI("ULC1001.exe",6640.000000)
GUI.write_register("ULC1001","PWR_CTL",0x0) # put device in active mode
GUI.write_register("USER_Commands","USER_Commands_userCommand",0xE) # command for Reinit
GUI.write_register("USER_Commands","USER_Commands_flag_newCommand",0x1) # sets lock bit
time.sleep(0.01) #delay 10ms
GUI.write_register("ULC1001","PWR_CTL",0x02) # returns device to Software Shutdown
  
```

5.5.4 Fault and Flag Monitoring and Clearing

The GUI Monitor flags and faults are Green/Red LED boxes located in the North Pane. ULC1001 reports back 5 flags and also reads two faults from the DRV290x amplifier. On the right side of the North Pane, there is a check box to enable or disable the Fault Monitor feature of the GUI, which reads both flags and faults. The fault monitor period is 500ms. The reading of the fault registers is not logged by the Status Log detailed in [Section 5.5.1](#) or in the Python Script Recorder described in [Section 5.5.9](#). The Flag and Fault Indicators are cleared when the *Clear Faults* button is selected.

The Faults and Flags are described in [Table 5-12](#). The sequences for reading faults is in [Table 5-13](#), and the sequence for clearing faults is in [Table 5-14](#).

Table 5-12. Faults and Flags

Flag Name	Register	Description
Over Power	USER_Flags_flag_overPowerFault	Sticky Flag set when power is over the Upper Threshold.
Under Power	USER_Flags_flag_underPowerFault	Sticky Flag set when power is under the Lower Threshold.
System Fault	USER_Flags_flag_systemFault	Sticky Flag set when System Fault Mode is run and the LCS has a mechanical failure.
Open Load	USER_Flags_flag_openLoad	Sticky Flag set when the measured LCS current is too low.
Over Temp	USER_Flags_flag_overTemp	Sticky Flag set when the measured LCS temperature is above user set OverTemp Threshold.
DRV_ERR	INT_LTCH7, bit 6	Sticky Fault set by DRV290x.
DRV_ERR2	INT_LTCH7, bit 7	Sticky Fault set by DRV290x when over temperature event occurs.

Table 5-13. Read Flags and Faults Sequence

Register	Read/Write	Data	Description
00	W	00	Change to Page 0.
7F	W	00	Change to Book 0.
02	W	00	Put device in active mode.
NA	NA	NA	Wait 5ms.
00	W	1A	Change to page 0x1A.
60	R	NA	Open Load Flag.
64	R	NA	Over Power Flag.
68	R	NA	Over Temp Flag.
6C	R	NA	System (LCS) Flag.
70	R	NA	Under Power Flag.
00	W	02	Change to page 2.
34	R	NA	Bit 6 = DRV290x SDZ Fault. Bit 7 = DRV290x OTW Fault.
00	W	00	Change to page 0.
02	W	02	Put device in software shutdown mode.

Table 5-14. Clear Flags and Faults Sequence

Register	Read/Write	Data	Description
00	W	00	Change to Page 0.
7F	W	00	Change to Book 0.
02	W	00	Put device in active mode.
NA	NA	NA	Wait 5ms.
00	W	1A	Change to page 0x1A.
58	W	0000000D	Set ClearFlags Command in the UserCommand Register.
5C	W	00000001	Tells device there is a new command to be executed.
NA	NA	NA	Wait until above register, 0x5C, = 0. (5ms).
00	W	00	Change to page 0.
30	W	05	Bit 2 = 1 clears sticky faults. Default register value is 0x01.
02	W	02	Put device in software shutdown mode.

In the GUI, the following script can be used in the Python window to clear the flags.

```

GUI_Module=__import__('ULC1001')
import time

GUI=GUI_Module.Device_GUI("ULC1001.exe",6640.000000)
GUI.write_register("ULC1001","PWR_CTL",0x0) # put device in active mode
GUI.write_register("USER_Commands","USER_Commands_userCommand",0xD) # command for ClearFaults
GUI.write_register("USER_Commands","USER_Commands_flag_newCommand",0x1) # sets lock bit
time.sleep(0.01) #delay 10ms
GUI.write_register("ULC1001","INT & CLK CFG",0x1D) # clears hardware sticky flauts
GUI.write_register("ULC1001","PWR_CTL",0x02) # returns device to Software Shutdown
  
```

5.5.5 Run Calibration

When the ULC1001-DRV290x EVM is connected and powered, the calibration mode must be run first and needs to be repeated when there is a change in the impedance of the LCS. A change includes changing the wire length or wire gauge connection from the ULC1001 to the LCS.

For calibration, the ULC1001 measures the impedance across multiple frequency ranges to solve for two resonance frequencies and a temperature constant for gauging the temperature of the LCS. The Calibration mode can contain up to five bursts as described in [Section 5.2.2](#). There are multiple adjustable settings for the calibration burst as described in [Table 5-2](#). The calibration burst can be configured for different types of ultrasonic lens cover systems. This user's guide details through the setup for a system with two modes of vibration or two frequency ranges.

Note

After running Calibration mode, all bursts in [Table 4-2](#) are updated based on the calibration results. If a calibration burst (1-3, 5) is not run, then the returning values are 0. Perform additional updates to [Table 5-3](#) to start and stop frequencies after running Calibration mode.

Performing Calibration mode using the following steps:

1. Clear the LCS of any debris or water and setup up in a room temperature environment (23°C).
2. Choose an appropriate amplitude for all chirp parameters.
TI recommended an amplitude of 0.65 μ V for the TI LCS with stemnic transducers.
3. Choose the start frequency (*Freq_Start*) and stop frequency (*Freq_Stop*) for each calibration burst type (1-3, 5). $Freq_Stop \geq Freq_Start$ is required. The Calibration Mode searches for the programmed values in this frequency range; refer to [Table 5-5](#). The GUI automatically slightly adjusts the frequency values and the *Num_Freq* chirp parameter to optimize the calibration burst parameters. $Num_Freq \leq 32$ is required.
4. Run Calibration Mode using the *Run/Play* button next to the mode configuration matrix in the calibration high level page.
5. Wait until Calibration Mode completes (all but the GUI *Abort/Reset Sequence* button is grayed out as the calibration mode runs).
6. Note the Region Parameters (*R1 Frequency* and *R2 Frequency*). These parameters must lie within the frequency ranges chosen in step 3. If so, then calibration is complete. If not, then repeat the step 3 above by updating *Freq_Start* and *Freq_Stop* as follows:
 - a. If the Region Frequency = *Freq_Start*, then choose a lower *Freq_Start* for the corresponding Burst Type. Satisfying $Num_Freq \leq 32$ can also require lowering *Freq_Stop*.
 - b. If the Region Frequency = *Freq_Stop*, then choose a higher *Freq_Stop* for the corresponding *Burst Type* frequency. Satisfying $Num_Freq \leq 32$ can also require raising *Freq_Start*.

Note

An impedance analyzer, like the Bode 100™, can be used to find the resonance frequencies of the LCS and, thus more quickly determines the frequency start and stop parameters for Calibration Mode. However, LCS resonance frequencies are dependent on the drive voltage. Thus, the Calibration Mode computation of **R1 - Frequency** and **R2 - Frequency** can be shifted from the values found using an impedance analyzer.

Note

Exercise caution when changing the Region Parameters manually; certain frequencies can create high voltages and damage the circuitry in the ULC1001-DRV290x EVM.

The register sequence for running calibration mode is displayed in [Table 5-15](#).

Table 5-15. Calibration Mode Sequence

Register	Read/Write	Data	Description
00	W	00	Change to Page 0
7F	W	00	Change to Book 0
02	W	00	Put device in active mode.
NA	NA	NA	Wait 5ms
00	W	1A	Change to page 0x1A
58	W	00000002	Set Calibration Command in the UserCommand Register
5C	W	00000001	Tells device there is a new command to be executed.
NA	NA	NA	Wait until above register, 0x5C, = 0 . <i>The wait time depends on the calibration modes' settings.</i>
00	W	00	Change to page 0
02	W	02	Put device in software shutdown mode

In the GUI, the following script can be used in the Python window to calibrate the system.

```
GUI_Module=__import__('ULC1001')
import time

GUI=GUI_Module.Device_GUI("ULC1001.exe",6640.000000)
GUI.write_register("ULC1001","PWR_CTL",0x0) # put device in active mode
GUI.write_register("USER_Commands","USER_Commands_userCommand",0x2) # command for Calibration
GUI.write_register("USER_Commands","USER_Commands_flag_newCommand",0x1) # sets lock bit
time.sleep(x) # set appropriate wait time
GUI.write_register("ULC1001","PWR_CTL",0x02) # returns device to Software Shutdown
```

5.5.6 Run Cleaning Modes

Texas Instruments created three main cleaning modes for removing ice, mud and water from the lens of the LCS and an Auto mode that can be programmed to drive a cleaning sequence when mass, such as water, is detected on the lens. Two additional custom modes are also available for flexibility. Assuming the user has already run Calibration Mode and updated the appropriate settings, a cleaning mode can be run by hitting the *Run/Play* buttons next to the mode configuration matrix in the Cleaning Modes High Level Page. For convenience, the *Run/Play* buttons automatically put the device in *Active Mode* and send a Reinit System command before the mode is run. The device is returned to *Software Shutdown Mode* after a cleaning mode. TI highly recommends the *Amp (pV)* settings for each burst of the cleaning modes equal the *Amp (pV)* settings used when Calibration Mode was run.

When running any cleaning mode, all but the GUI *Abort Sequence* button is grayed out. The *Abort Sequence* button ends the running mode and resets the ULC1001-DRV290x EVM to the state of the device just before the cleaning mode was initiated.

Note

Do not check the Continuous Mode check box and the Continuous Auto Mode check box when running Auto Mode. See [Section 5.2.3.1](#).

The register sequence for running calibration mode is displayed in [Table 5-16](#).

Table 5-16. Cleaning Mode Sequence

0x3 = Custom Mode 1, 0x4 = Custom Mode 2, 0x5 = Deice, 0x6 = Auto Mode, and 0x7 = Mud mode.

Register	Read/Write	Data	Description
00	W	00	Change to Page 0
7F	W	00	Change to Book 0
02	W	00	Put device in active mode
NA	NA	NA	Wait 5ms
00	W	1A	Change to page 0x1A
58	W	0000000X	Set Cleaning Mode Command in the UserCommand Register
5C	W	00000001	Notifies the device there is a new command to be executed
NA	NA	NA	Wait until above register, 0x5C, = 0. The wait time depends on the cleaning modes' settings.
00	W	00	Change to page 0
02	W	02	Put device in software shutdown mode

In the GUI, the following script can be used in the Python window to run a cleaning mode. The cleaning modes are *0x3 = Custom Mode 1, 0x4 = Custom Mode 2, 0x5 = Deice, 0x6 = Auto Mode, and 0x7 = Mud mode.*

```
GUI_Module=__import__('ULC1001')
import time

GUI=GUI_Module.Device_GUI("ULC1001.exe",6640.000000)
GUI.write_register("ULC1001","PWR_CTL",0x0) # put device in active mode
# Set Cleaning Command (0x3-0x7)
GUI.write_register("USER_Commands","USER_Commands_userCommand",0xX) # set Cleaning Command
GUI.write_register("USER_Commands","USER_Commands_flag_newCommand",0x1) # sets lock bit
time.sleep(x) # set appropriate wait time
GUI.write_register("ULC1001","PWR_CTL",0x02) # returns device to Software Shutdown
```

5.5.7 Run Diagnostic Mode

Texas Instruments created two additional modes to regulate the power delivered to the LCS, identify the faults of LCS, and check for an open load condition on the output. Refer to [Section 4.5](#) for more details on the diagnostic modes. Assuming the user has already run Calibration Mode and updated the appropriate settings, a diagnostic mode can be run by hitting the *Run/Play* buttons next to the mode configuration matrix in the Power and Diagnostics high level page. For convenience, the *Run/Play* buttons automatically put the device in *Active Mode* and send a *Reinit System* command before the mode is run. The device is returned to *Software Shutdown Mode* after a diagnostic mode. TI highly recommends the *Amp (pV)* settings for each burst of the diagnostics modes equal the *Amp (pV)* settings used when Calibration Mode was run.

The register sequence for running calibration mode is displayed in [Table 5-17](#).

Table 5-17. Diagnostic Mode Sequence

0x8 = Power Mode, 0x9 = System Fault Mode

Register	Read/Write	Data	Description
00	W	00	Change to Page 0
7F	W	00	Change to Book 0
02	W	00	Put device in active mode
NA	NA	NA	Wait 5ms
00	W	1A	Change to page 0x1A
58	W	0000000X	Set Diagnostic Mode Command in the UserCommand Register
5C	W	00000001	Notifies the device there is a new command to be executed.

Table 5-17. Diagnostic Mode Sequence (continued)

0x8 = Power Mode, 0x9 = System Fault Mode

Register	Read/Write	Data	Description
NA	NA	NA	Wait until above register, 0x5C, = 0 . The wait time depends on the settings of the diagnostic modes.
00	W	00	Change to page 0
02	W	02	Put device in software shutdown mode

In the GUI, the following script can be used in the Python window to run a cleaning mode. The cleaning modes are *0x8 = Power Mode, 0x9 = System Fault Mode*

```
GUI_Module=__import__('ULC1001')
import time

GUI=GUI_Module.Device_GUI("ULC1001.exe",6640.000000)
GUI.write_register("ULC1001","PWR_CTL",0x0) # put device in active mode
# Set Diagnostic Command (0x8-0x9)
GUI.write_register("USER_Commands","USER_Commands_userCommand",0xX) # set Diagnostic Command
GUI.write_register("USER_Commands","USER_Commands_flag_newCommand",0x1) # sets lock bit
time.sleep(x) # set appropriate wait time
GUI.write_register("ULC1001","PWR_CTL",0x02) # returns device to Software Shutdown
```

5.5.8 Run Abort

The Abort sequence can be executed to stop the cleaning, calibration, diagnostic or power mode being run.

Table 5-18. Abort Sequence

0x1 = Abort Mode

Register	Read/Write	Data	Description
00	W	00	Change to Page 0
7F	W	00	Change to Book 0
00	W	1A	Change to Page 0x1A
58	W	00000001	Abort the system
NA	NA	NA	Wait 1ms
00	W	00	Change to Page 0
01	W	01	SW Reset
NA	NA	NA	Wait 2ms
NA	W	NA	Re-load all registers

In the GUI, the following script can be used in the Python window to run an Abort mode. The Abort mode is $0x1$ = *Abort*.

```
GUI_Module=__import__('ULC1001')
import time

GUI=GUI_Module.Device_GUI("ULC1001.exe",6640.000000)
# Set Abort Command (0x1)
GUI.write_register("USER_Commands","USER_Commands_userCommand",0x1) # set Abort Command
time.sleep(x) # set appropriate wait time
GUI.write_register("ULC1001","SW_RESET",0x1)
time.sleep(x) # set appropriate wait time
# Re-load all registers
```

5.5.9 Script Recording

The GUI register read/write operations can be recorded in a script file, stored, and replayed as needed. Saving and running a recorded script is similar to saving and loading a configuration file, as described in [Section 5.5.2](#). However, a script recording has the benefit of saving the exact sequences of GUI button clicks and setting changes.

The Script Recording Window is launched from the Script Menu, as shown in [Figure 5-17](#), or by the shortcut in the Tools Bar. The Python Recording Window flashes green, as shown in [Figure 5-18](#), when the *Start Recording* button is pressed. The window turns white when *Stop Recording* button is pressed.

A Script can be saved as shown in [Figure 5-19](#) and a script can be re-opened and run as shown in [Figure 5-20](#). Some commands require a wait time for the system to initialize or be put into active mode. Inserting the Python Time library and using wait commands is possible.

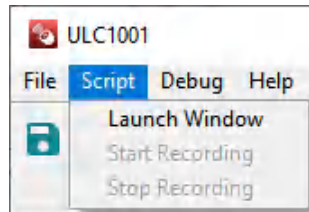

Figure 5-17. Script Menu

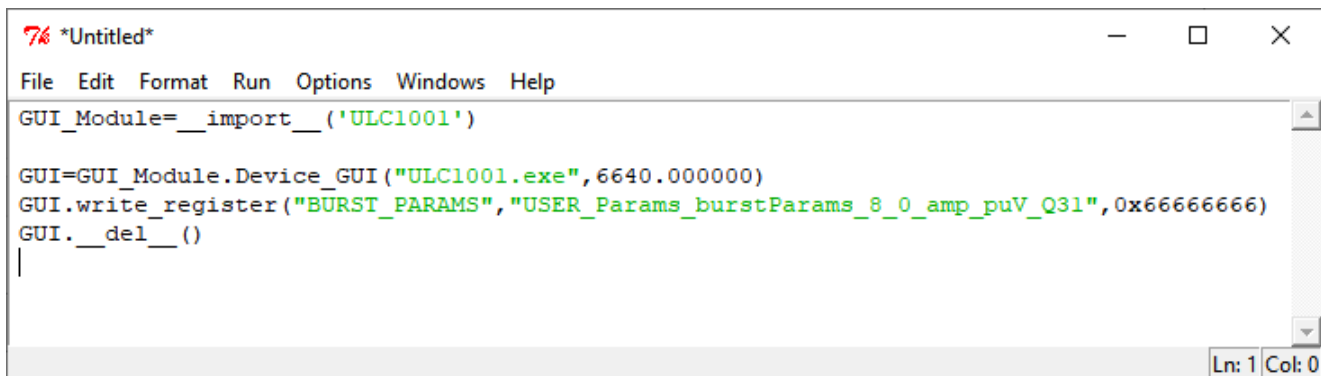

Figure 5-18. Python Recording Window

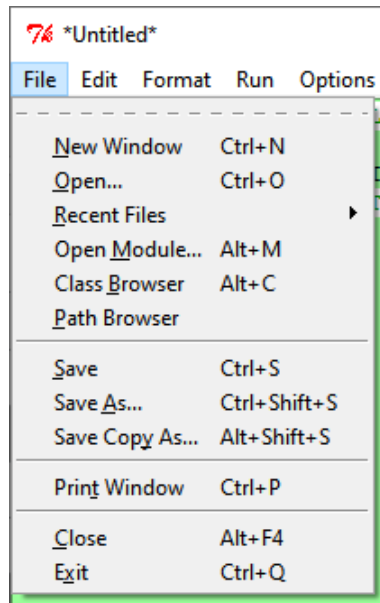

Figure 5-19. Saving Recorded Python Script

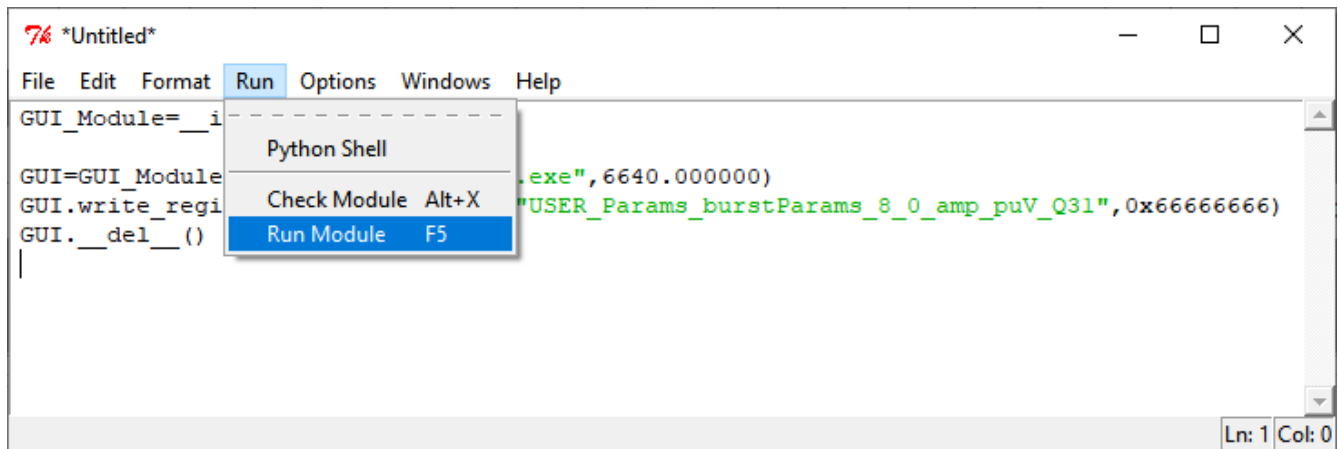

Figure 5-20. Running Recorded Python Script

6 Hardware Design Files

6.1 Schematics

The ULC1001-DRV290x EVM Schematics are shown in [Figure 6-1](#), [Figure 6-2](#), and [Figure 6-3](#).

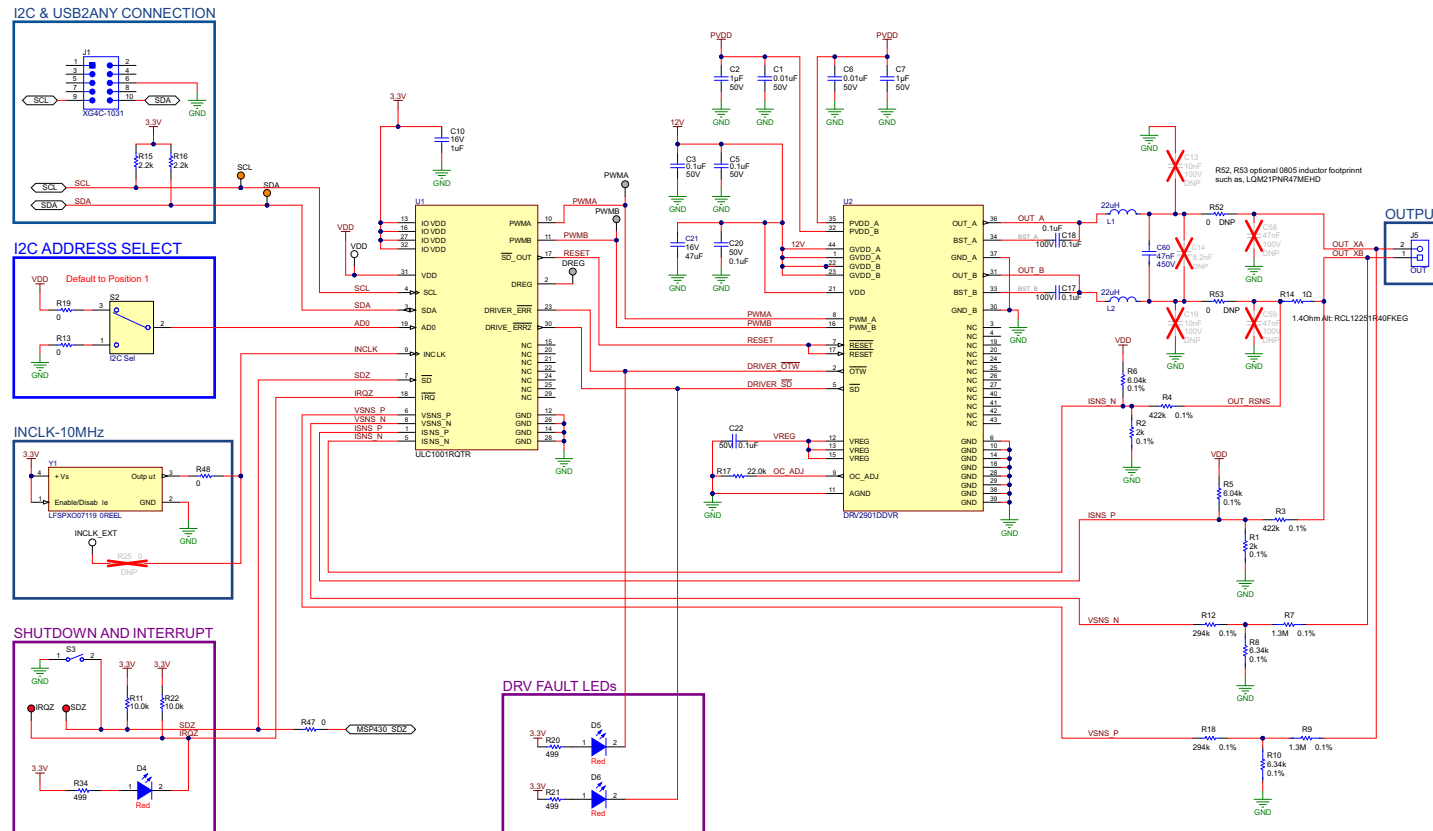

Figure 6-1. ULC1001-DRV290x EVM Schematic

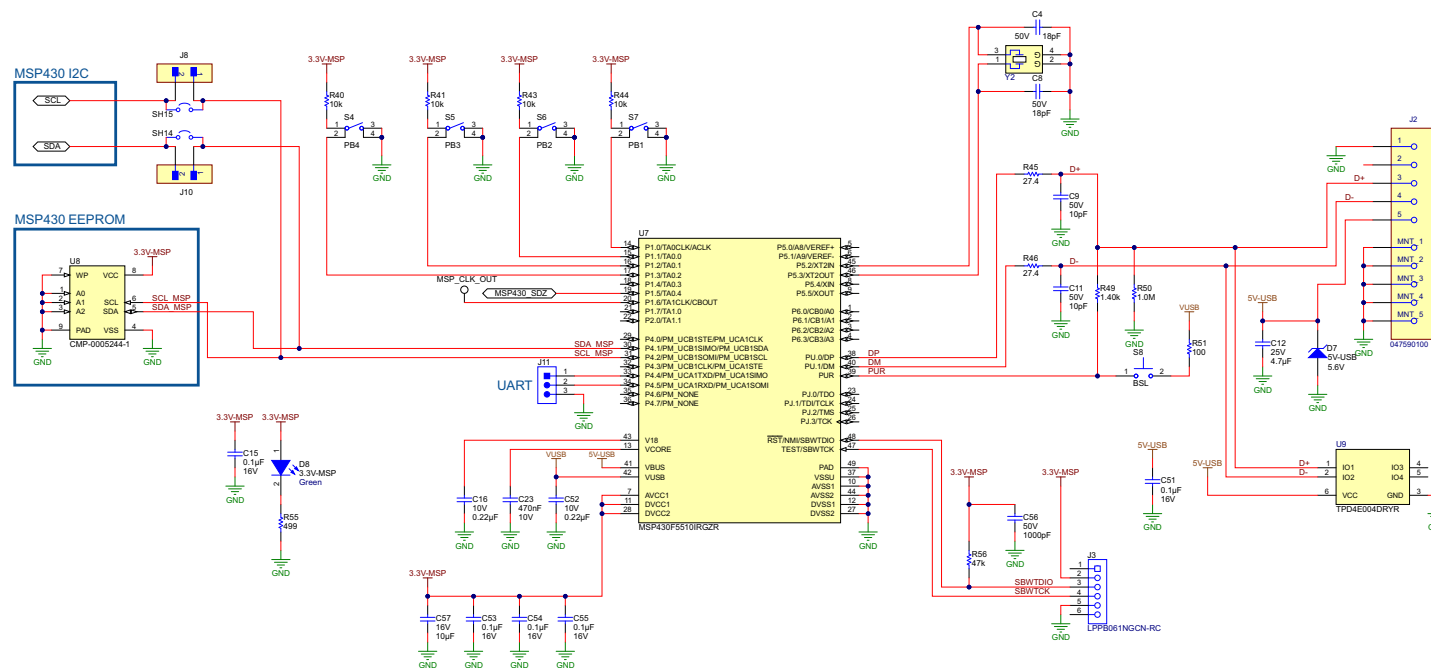
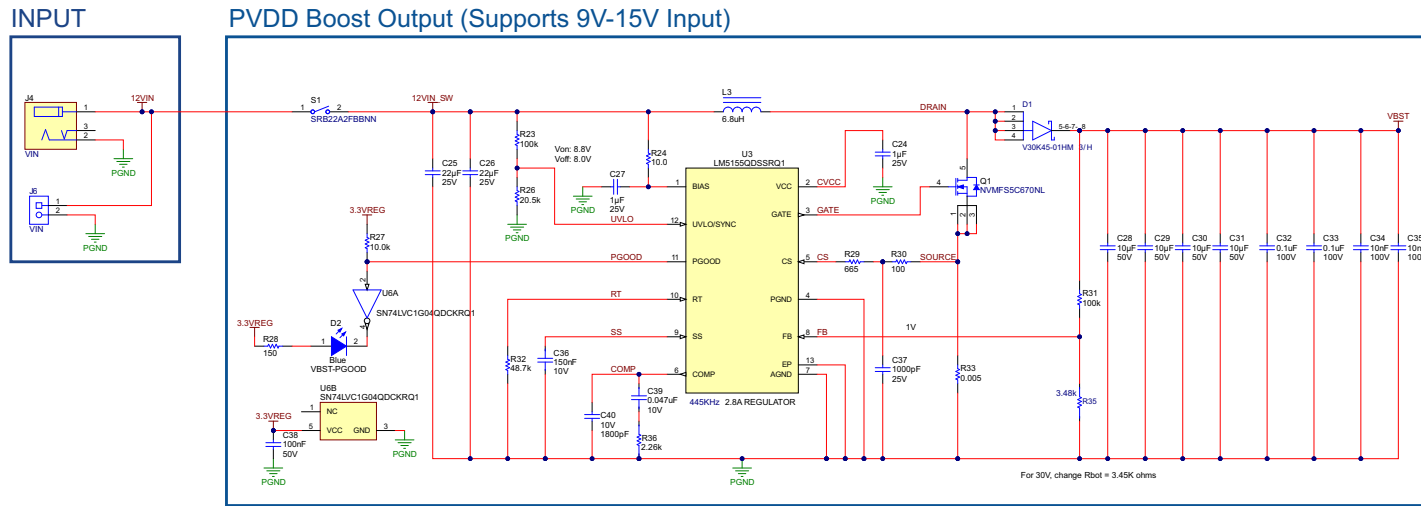
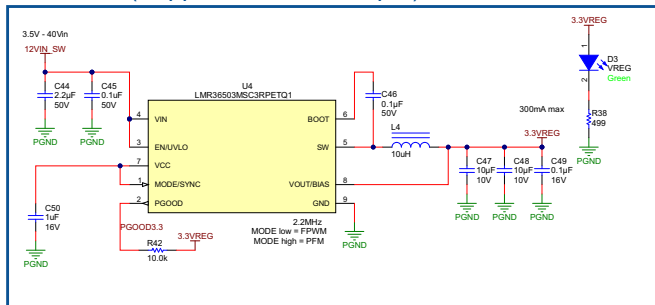

Figure 6-2. ULC1001-DRV290x EVM MSP430 Schematic



3.3V Buck (Supports 3.5V-40V Input)



12V LDO (Input from Boost)

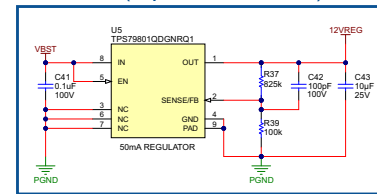

Power Jumpers

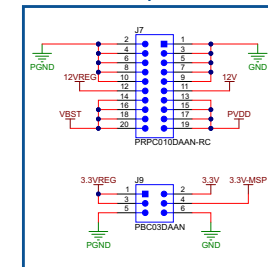

Figure 6-3. ULC1001-DRV290x EVM Power Supplies

6.2 PCB Layouts

The ULC1001-DRV290X EVM Layer Plots are shown in the figures below.

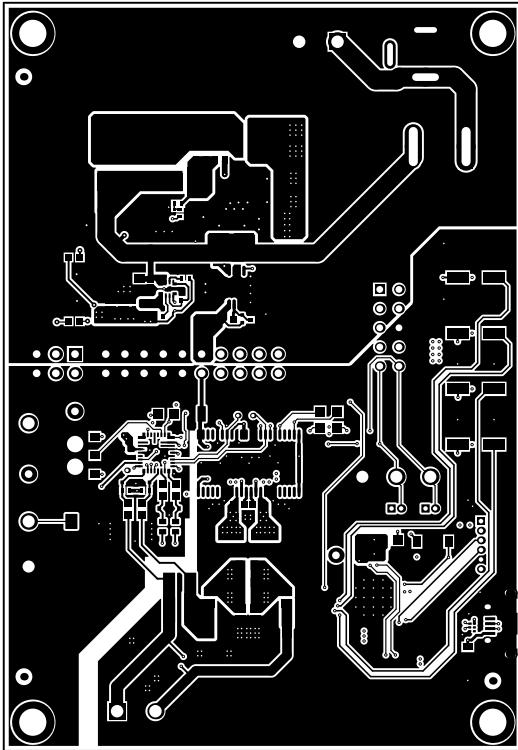

Figure 6-4. Top Layer

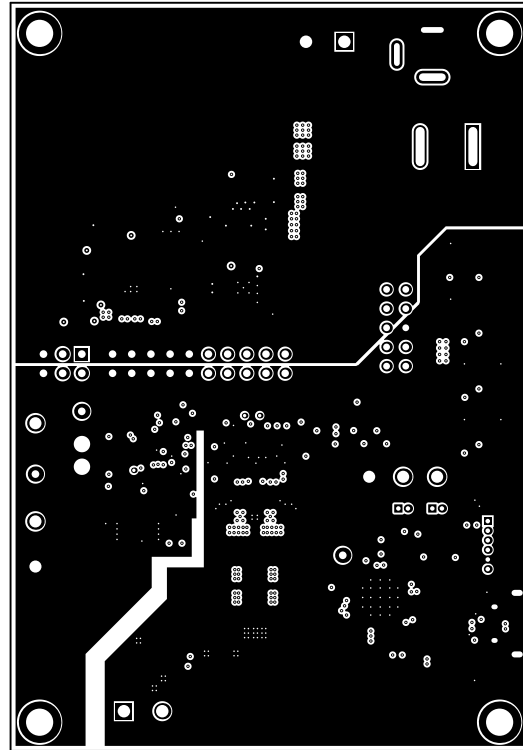

Figure 6-5. Signal Layer 1

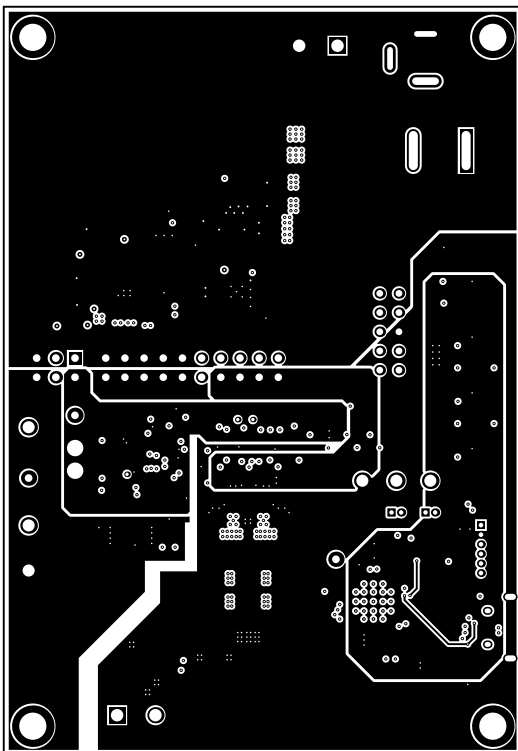

Figure 6-6. Signal Layer 2

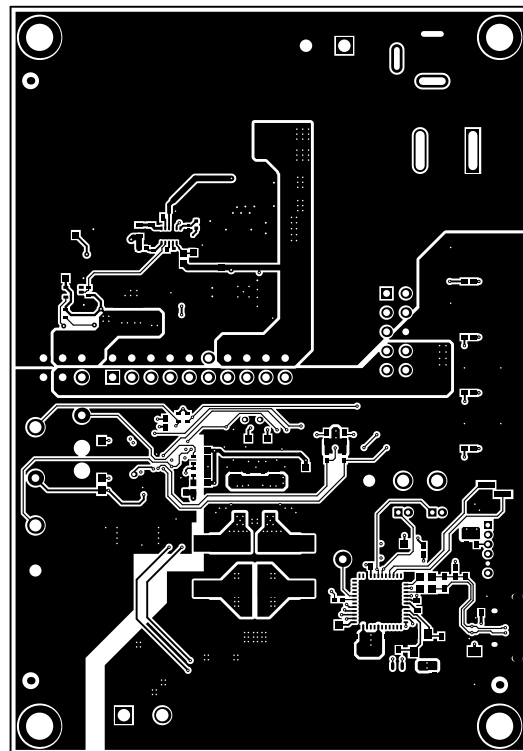

Figure 6-7. Bottom Layer

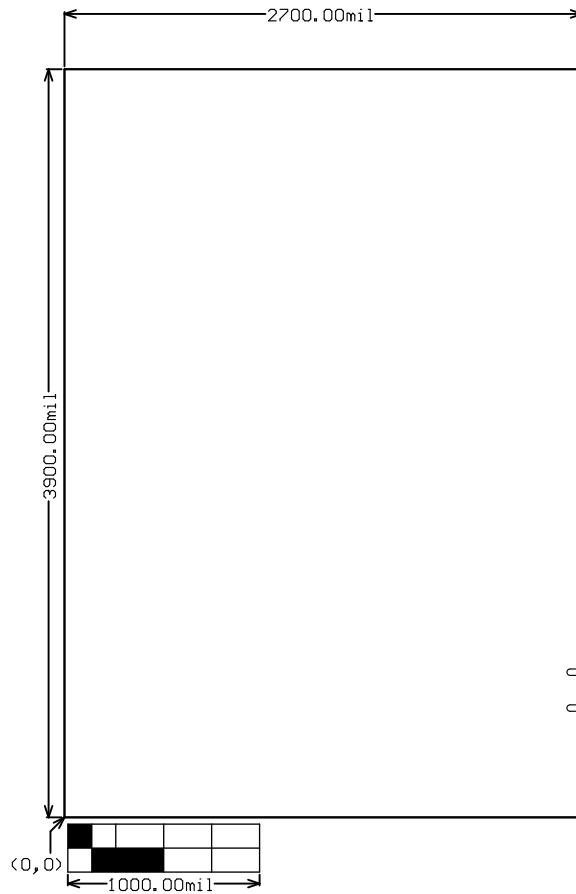

Figure 6-8. Board Dimensions

6.3 Bill of Materials (BOM)

Table 6-1. ULC1001-DRV290X EVM Bill of Materials

Designator	Quantity	Description	Package Reference	Part Number	Manufacturer	Value
C1, C6	2	CAP, CERM, 0.01uF, 50V, +/- 10%, X7R, AEC-Q200 Grade 1, 0402	0402	CGA2B3X7R1H103K050BB	TDK	0.01uF
C2, C7	2	CAP, CERM, 1uF, 50V, +/- 10%, X7R, AEC-Q200 Grade 1, 0805	0805	CGA4J3X7R1H105K125AB	TDK	1uF
C3, C5, C20, C22, C38, C45	6	CAP, CERM, 0.1uF, 50V, +/- 10%, X7R, AEC-Q200 Grade 1, 0603	0603	CGA3E2X7R1H104K080AA	TDK	0.1uF
C4, C8	2	CAP, CERM, 18pF, 50V,+/- 5%, C0G/NP0, 0402	0402	CL05C180JB5NNNC	Samsung Electro-Mechanics	18pF
C9, C11	2	CAP, CERM, 10pF, 50V, +/- 5%, C0G/NP0, AEC-Q200 Grade 1, 0402	0402	CGA2B2C0G1H100D050BA	TDK	10pF
C10, C50	2	CAP, CERM, 1uF, 16V, +/- 10%, X5R, 0402	0402	EMK105BJ105KVHF	Taiyo Yuden	1uF
C12	1	CAP, CERM, 4.7uF, 25V,+/- 10%, X7R, AEC-Q200 Grade 1, 1206	1206	GCM31CR71E475KA55L	MuRata	4.7uF
C15, C51, C53, C54, C55	5	CAP, CERM, 0.1uF, 16V,+/- 10%, X7R, 0402	0402	EMK105B7104KV-F	Taiyo Yuden	0.1uF
C16, C52	2	CAP, CERM, 0.22uF, 10V,+/- 10%, X7R, AEC-Q200 Grade 1, 0402	0402	LMK105B7224KVHF	Taiyo Yuden	0.22uF
C17, C18, C32, C33, C41	5	CAP, CERM, 0.1uF, 100V, +/- 10%, X7R, 0603	0603	GRM188R72A104KA35J	MuRata	0.1uF
C21	1	47uF ±10% 16V Ceramic Capacitor X6S 1210 (3225 Metric)	1210	GRT32EC81C476KE13L	Murata	
C23	1	CAP, CERM, 0.47uF, 10V, +/- 10%, X7R, 0603	0603	C0603C474K8RACTU	Kemet	0.47uF
C24, C27	2	CAP, CERM, 1uF, 25V, +/- 10%, X7R, AEC-Q200 Grade 1, 0603	0603	GCM188R71E105KA64D	MuRata	1uF
C25, C26	2	CAP, CERM, 22uF, 25V,+/- 10%, X7R, 1210	1210	CL32B226KAJNFNE	Samsung Electro-Mechanics	22uF
C28, C29, C30, C31	4	CAP, CERM, 10uF, 50V,+/- 10%, X7R, 1210	1210	CL32B106KBJNNWE	Samsung Electro-Mechanics	10uF
C34, C35	2	CAP, CERM, 0.01uF, 100V, +/- 10%, X7R, AEC-Q200 Grade 1, 0603	0603	CGA3E2X7R2A103K080AA	TDK	0.01uF
C36	1	0.15uF ±20% 10V Ceramic Capacitor X7R 0402 (1005 Metric)	0402	CGA2B1X7R1A154M050BC	TDK	
C37	1	CAP, CERM, 1000pF, 25V, +/- 10%, X7R, AEC-Q200 Grade 1, 0201	0201	CGA1A2X7R1E102K030BA	TDK	1000pF
C39	1	Multilayer Ceramic Capacitor 0.047uF 10V 10% 0402 Paper T/R	0402	LMF105B7473KVHF	Taiyo Yuden	
C40	1	CAP, CERM, 1800pF, 10V, +/- 10%, X7R, 0201	0201	GRM033R71A182KA01D	MuRata	1800pF
C42	1	CAP, CERM, 100pF, 100V, +/- 5%, C0G/NP0, AEC-Q200 Grade 1, 0603	0603	GCM1885C2A101JA16D	MuRata	100pF
C43	1	CAP, CERM, 10uF, 25V,+/- 10%, X7R, AEC-Q200 Grade 1, 1206	1206	CGA5L1X7R1E106K160AE	TDK	10uF
C44	1	CAP, CERM, 2.2uF, 50V, +/- 10%, X7R, AEC-Q200 Grade 1, 0805	0805	CGA4J3X7R1H225K125AB	TDK	2.2uF
C46	1	CAP, CERM, 0.1uF, 50V,+/- 10%, X7R, AEC-Q200 Grade 1, 0402	0402	CGA2B3X7R1H104K050BD	TDK	0.1uF

Table 6-1. ULC1001-DRV290X EVM Bill of Materials (continued)

Designator	Quantity	Description	Package Reference	Part Number	Manufacturer	Value
C47, C48	2	CAP, CERM, 10µF, 10V,+/- 10%, X7R, AEC-Q200 Grade 1, 0805	0805	GCJ21BR71A106KE01L	MuRata	10uF
C49	1	CAP, CERM, 0.1µF, 16V,+/- 5%, X7R, AEC-Q200 Grade 1, 0402	0402	GCM155R71C104JA55D	MuRata	0.1uF
C56	1	CAP, CERM, 1000pF, 50V, +/- 5%, C0G/NP0, 0402	0402	C1005NP01H102J050BA	TDK	1000pF
C57	1	CAP, CERM, 10µF, 16V,+/- 20%, X5R, 0805	0805	885012107014	Würth Elektronik	10uF
C60	1	CAP, CERM, 47nF ±10% 450V X7T SMD 0805	0805	C2012X7T2W473K125AA	TDK	47nF
D1	1	Diode Schottky 45V 30A Surface Mount FlatPAK (5x6)	FlatPAK5x6	V30K45-01HM3/H	Vishay	
D2	1	LED, Blue, SMD	1.6x0.8mm	LTST-C193TBKT-5A	Lite-On	Blue
D3	1	LED, Green, SMD	1.6x0.8mm	LTST-C193KGKT-5A	Lite-On	Green
D4, D5, D6	3	LED, Red, SMD	Red 0805 LED	LTST-C170KRKT	Lite-On	Red
D7	1	Diode, Zener, 5.6V, 500mW, SOD-123	SOD-123	MMSZ5232B-7-F	Diodes Inc.	5.6V
D8	1	LED, Green, SMD	0805 LED	LTST-C171GKT	Lite-On	Green
H1, H2, H3, H4	4	MACHINE SCREW PAN PHILLIPS M3	M3 Screw	RM3X8MM 2701	APM HEXSEAL	
H5, H6, H7, H8	4	Standoff, Hex, 12mm, M3, Aluminum	Aluminum M3 12mm Hex Standoff	24434	Keystone	
INCLK_EXT, MSP_CLK_OUT, VDD	3	Test Point, Miniature, White, TH	White Miniature Testpoint	5002	Keystone	
IRQZ, SDZ	2	Test Point, Multipurpose, Red, TH	Red Multipurpose Testpoint	5010	Keystone Electronics	
J1	1	Header (shrouded), 100mil, 5x2, Gold, TH	TH, 10-Leads, Body 8.5x20mm, Pitch 2.54mm	XG4C-1031	Omron Electronic Components	
J2	1	USB - micro AB - Receptacle Connector 5 Position Surface Mount, Right Angle; Through Hole	CONN_USB_7MM50_5M M90	0475901001	Molex	
J3	1	Receptacle, 50mil, 6x1, Gold, R/A, TH	6x1 Receptacle	LPPB061NGCN-RC	Sullins Connector Solutions	
J4	1	Power Jack, mini, 2.5mm OD, R/A, TH	Jack, 14.5x11x9mm	RAPC712X	Switchcraft	
J5, J6	2	Terminal Block, 5.08mm, 2x1, TH	Terminal Block, 5.08mm, 2x1, TH	039544-3002	Molex	
J7	1	Header, 2.54mm, 10x2, Gold, TH	Header, 2.54mm, 10x2, TH	PRPC010DAAN-RC	Sullins Connector Solutions	
J8, J10	2	Connector Header Through Hole 2 position 0.050" (1.27mm)	HDR2	M50-3530242	Harwin	
J9	1	Header, 100mil, 3x2, Gold, TH	Sullins 100mil, 2x3, 230 mil above insulator	PBC03DAAN	Sullins Connector Solutions	
J11	1	Header, 1.27mm, 3x1, Gold, SMT	Header, 1.27mm, 3x1, SMT	GRPB031VWTC-RC	Sullins Connector Solutions	
L1, L2	2	22µH Shielded Drum Core, Wirewound Inductor 2.5A 170mOhm Max Nonstandard	SMT2_7MM3_6MM6	SRP7050TA-220M	Bourns	22uH
L3	1	Inductor, Shielded, Composite, 6.8uH, 18.5A, 0.01ohm, SMD	Inductor, 11.3x10x10mm	XAL1010-682MEB	Coilcraft	6.8uH

Table 6-1. ULC1001-DRV290X EVM Bill of Materials (continued)

Designator	Quantity	Description	Package Reference	Part Number	Manufacturer	Value
L4	1	Inductor, Shielded, Composite, 10uH, 0.61A, 0.56ohm, SMD	XPL2010	XPL2010-103MLB	Coilcraft	10uH
LBL1	1	Thermal Transfer Printable Labels, 0.650" W x 0.200" H - 10,000 per roll	PCB Label 0.650 x 0.200 inch	THT-14-423-10	Brady	
Q1	1	MOSFET, N-CH, 60V, 71A, AEC-Q101, SO-8FL	SO-8FL	NVMFS5C670NL	ON Semiconductor	60V
R1, R2	2	RES SMD 2K OHM 0.1% 1/16W 0402	0402	ERA-2AEB202X	Panasonic	
R3, R4	2	RES, 422 k, 0.1%, 0.1 W, 0603	0603	RT0603BRD07422KL	Yageo America	422k
R5, R6	2	RES, 6.04 k, 0.1%, 0.063 W, 0402	0402	ERA-2AEB6041X	Panasonic	6.04k
R7, R9	2	1.3 MOhms \pm 0.1% 0.125W, 1/8W Chip Resistor 0603 (1608 Metric) Anti-Sulfur, Automotive AEC-Q200 Thin Film	0603	MCT0603MD1304BP500	Vishay Dale	1.3M
R8, R10	2	Res Thin Film 0402 6.34K Ohm 0.1% 1/16W \pm 25ppm/ $^{\circ}$ C Molded SMD Paper T/R	0402	RT0402BRD076K34L	Yageo	6.34k
R11, R22, R27, R42	4	RES, 10.0 k, 1%, 0.063 W, 0402	0402	RC0402FR-0710KL	Yageo America	10.0k
R12, R18	2	RES, 294 k, 0.1%, 0.1 W, 0603	0603	RT0603BRD07294KL	Yageo America	294k
R13, R19	2	RES, 0, 5%, 0.1 W, 0603	0603	RC0603JR-070RL	Yageo	0
R14	1	1 Ohms \pm 1% 2W Chip Resistor Wide 2512 (6432 Metric), 1225 Automotive AEC-Q200 Thick Film	2512	RCL12251R00FKEG	Vishay Dale	
R15, R16	2	RES, 2.2 k, 5%, 0.063 W, AEC-Q200 Grade 0, 0402	0402	CRCW04022K20JNED	Vishay-Dale	2.2k
R17	1	RES, 22.0 k, 1%, 0.1 W, 0603	0603	RC0603FR-0722KL	Yageo	22.0k
R20, R21, R34	3	RES, 499, 1%, 0.063 W, AEC-Q200 Grade 0, 0402	0402	CRCW0402499RFKED	Vishay-Dale	499
R23, R39	2	RES, 100 k, 1%, 0.1 W, 0402	0402	ERJ-2RKF1003X	Panasonic	100k
R24	1	RES, 10.0, 1%, 0.1 W, AEC-Q200 Grade 0, 0603	0603	CRCW060310R0FKEA	Vishay-Dale	10.0
R26	1	RES, 20.5 k, 1%, 0.063 W, AEC-Q200 Grade 0, 0402	0402	CRCW040220K5FKED	Vishay-Dale	20.5k
R28	1	RES, 150, 1%, 0.063 W, AEC-Q200 Grade 0, 0402	0402	CRCW0402150RFKED	Vishay-Dale	150
R29	1	RES, 665, 1%, 0.063 W, AEC-Q200 Grade 0, 0402	0402	CRCW0402665RFKED	Vishay-Dale	665
R30	1	RES, 100, 1%, 0.1 W, 0402	0402	ERJ-2RKF1000X	Panasonic	100
R31	1	RES, 100 k, 1%, 0.1 W, AEC-Q200 Grade 0, 0603	0603	CRCW0603100KFKEA	Vishay-Dale	100k
R32	1	RES, 48.7 k, 1%, 0.063 W, AEC-Q200 Grade 0, 0402	0402	CRCW040248K7FKED	Vishay-Dale	48.7k
R33	1	RES, 0.005, 1%, 3 W, AEC-Q200 Grade 0, 2512	2512	CRE2512-FZ-R005E-3	Bourns	0.005
R35	1	3.48 kOhms \pm 1% 0.1W, 1/10W Chip Resistor 0603 (1608 Metric) Automotive AEC-Q200, Moisture Resistant Thick Film	0603	RK73H1JTDD3481F	KOA Speer	3.48k
R36	1	Res Thick Film 0201 2.26K Ohm 1% 1/20W \pm 200ppm/ $^{\circ}$ C Molded SMD SMD T/R	0201	ERJ-1GNF2261C	Panasonic Electronic Components	
R37	1	Res Thick Film 0402 825K Ohm 1% 1/10W \pm 100ppm/ $^{\circ}$ C Molded SMD Punched Carrier T/R	0402	ERJ-2RKF8253X	Panasonic	
R38, R55	2	RES, 499, 1%, 0.1 W, 0603	0603	CRCW0603499RFKEAC	Vishay-Dale	499
R40, R41, R43, R44	4	RES, 10 k, 5%, 0.063 W, AEC-Q200 Grade 0, 0402	0402	CRCW040210K0JNED	Vishay-Dale	10k

Table 6-1. ULC1001-DRV290X EVM Bill of Materials (continued)

Designator	Quantity	Description	Package Reference	Part Number	Manufacturer	Value
R45, R46	2	RES, 27.4, 1%, 0.1 W, 0603	0603	RC0603FR-0727R4L	Yageo	27.4
R47, R48	2	RES, 0, 5%, 0.1 W, AEC-Q200 Grade 0, 0402	0402	ERJ-2GE0R00X	Panasonic	0
R49	1	RES, 1.40 k, 1%, 0.063 W, 0402	0402	CRCW04021K40FKED	Vishay-Dale	1.40k
R50	1	RES, 1.0M, 5%, 0.063W, AEC-Q200 Grade 0, 0402	0402	CRCW04021M00JNED	Vishay-Dale	1.0Meg
R51	1	RES, 100, 1%, 0.063 W, 0402	0402	CRCW0402100RFKED	Vishay-Dale	100
R52, R53	2	RES, 0, 5%, 0.125 W, AEC-Q200 Grade 0, 0805	0805	ERJ-6GEY0R00V	Panasonic	0
R56	1	RES, 47 k, 5%, 0.063 W, AEC-Q200 Grade 0, 0402	0402	CRCW040247K0JNED	Vishay-Dale	47k
S1	1	Switch, SPST, Off-On, 10A, 125V, TH	15.01x19mm	SRB22A2FBBNN	Conergy	
S2	1	Switch, SPDT, Slide, On-On, 2 Pos, 0.1A, 12 VDC, R/A, SMD	7.2x4mm	AYZ0102AGRLC	C&K Components	
S3	1	Switch, SPST-NO, Off-Mom, 0.05A, 12 VDC, SMD	6x3.5mm	EVQ-5PN04K	Panasonic	
S4, S5, S6, S7	4	Switch, SPST-NO, Off-Mom, 0.05A, 12V, SMT	6x6mm	TL3301AF160QJ	E-Switch	
S8	1	Switch, Tactile, SPST-NO, 0.05A, 12V, SMT	Switch, 4.4x2x2.9 mm	TL1015AF160QG	E-Switch	
SCL, SDA	2	Test Point, Multipurpose, Orange, TH	Orange Multipurpose Testpoint	5013	Keystone Electronics	
SH14, SH15	2	1.27mm, 2 Pos. Female Jumper Socket, Handle Shunt, Black	CONN_SHUNT2	M50-2000005	Harwin	
SH-J1, SH-J2, SH-J3, SH-J4, SH-J5, SH-J6, SH-J7, SH-J8, SH-J9, SH-J10, SH-J11, SH-J12, SH-J13	13	Shunt, 100mil, Gold plated, Black	Shunt	SNT-100-BK-G	Samtec	1x2
TP1, TP2	2	Test Point, Multipurpose, Green, TH	Green Multipurpose Testpoint	5126	Keystone	
U1	1	Configurable Ultrasonic PWM Driver With I/V Sense Amplifiers	VQFN-HR32	ULC1001RQTR	Texas Instruments	
U2	1	Lens Cleaner Transducer Driver	HTSSOP44	DRV2901DDVR	Texas Instruments	
U3	1	Automotive Grade 2.2MHz Wide Input Non-synchronous Boost Controller, DSS0012C (WSON-12)	DSS0012C	LM5155QDSSRQ1	Texas Instruments	
U4	1	LMR36503/06-Q1 Wide Input 60V Synchronous, DC-DC Buck Converter, RPE0009A (VQFN-9)	RPE0009A	LMR36503MSC3RPETQ1	Texas Instruments	
U5	1	50mA, 3V to 50V, Micropower, Low-Dropout Linear Regulator, DGN0008B (VSSOP-8)	DGN0008B	TPS79801QDGNRQ1	Texas Instruments	
U6	1	Automotive Catalog Single Inverter, DCK0005A, LARGE T&R	DCK0005A	SN74LVC1G04QDCKRQ1	Texas Instruments	
U7	1	Mixed Signal Microcontroller, RGZ0048A (VQFN-48)	RGZ0048A	MSP430F5510IRGZR	Texas Instruments	
U8	1	512K I2C Serial EEPROM, DFN-8	DFN-8	24FC512-I/MF	Microchip	
U9	1	4-Channel ESD Protection Array for High-Speed Data Interfaces, DRY0006A (USON-6)	DRY0006A	TPD4E004DRYR	Texas Instruments	
Y1	1	10MHz XO (Standard) CMOS Oscillator 3.3V Enable/Disable 4-SMD, No Lead	SMT_XTAL_2MM0_1MM6	LFSPXO071190REEL	IQD	

Table 6-1. ULC1001-DRV290X EVM Bill of Materials (continued)

Designator	Quantity	Description	Package Reference	Part Number	Manufacturer	Value
Y2	1	Crystal, 24.000MHz, 18pF, SMD	3.2x0.8x2.5mm	ABM8-24.000MHZ-B2-T	Abracon Corporation	

7 Revision History

NOTE: Page numbers for previous revisions may differ from page numbers in the current version.

Changes from Revision B (April 2023) to Revision C (May 2024)	Page
• Deleted ULC1001-DRV-FL-EVM note.....	1
• Added LCS information.....	4
• Deleted ULC1001-DRV-FL-EVM note.....	4
• Added A1 sticker note.....	6
• Updated Auto Mode sequence and corresponding information.....	7
• Updated ISR Period relationship to frequency.....	8
• Added Manual Clocking Mode information.....	8
• Deleted burst 4.....	9
• Added Temp Burst (23) in Auto Mode information.....	11
• Added Altered System Fault recommended thresholds.....	15
• Added Calibration Mode setting registers	21
• Added Calibration Update registers	21
• Added Deice Threshold.....	24
• Added Temperature Burst information.....	25
• Added Abort Sequence.....	37

Changes from Revision A (February 2023) to Revision B (April 2023)	Page
• Added ULC1001-DRV-FL-EVM note.....	1
• Changed all instances of legacy terminology to controller and target where I ² C is mentioned.....	1
• Added ULC1001-DRV-FL-EVM note.....	4
• Changed ISR Rate to ISR Period.....	8
• Added clarification to Amp (puV) definition.....	18
• Added new Imag_max_sf equation and clarified other equations.....	23
• Changed DRV2901 output LC filter and R35.....	41

Changes from Revision * (September 2022) to Revision A (February 2023)	Page
• Updated Equation 3 and Equation 5	23
• Added comments for Q-point notation.....	27

IMPORTANT NOTICE AND DISCLAIMER

TI PROVIDES TECHNICAL AND RELIABILITY DATA (INCLUDING DATA SHEETS), DESIGN RESOURCES (INCLUDING REFERENCE DESIGNS), APPLICATION OR OTHER DESIGN ADVICE, WEB TOOLS, SAFETY INFORMATION, AND OTHER RESOURCES "AS IS" AND WITH ALL FAULTS, AND DISCLAIMS ALL WARRANTIES, EXPRESS AND IMPLIED, INCLUDING WITHOUT LIMITATION ANY IMPLIED WARRANTIES OF MERCHANTABILITY, FITNESS FOR A PARTICULAR PURPOSE OR NON-INFRINGEMENT OF THIRD PARTY INTELLECTUAL PROPERTY RIGHTS.

These resources are intended for skilled developers designing with TI products. You are solely responsible for (1) selecting the appropriate TI products for your application, (2) designing, validating and testing your application, and (3) ensuring your application meets applicable standards, and any other safety, security, regulatory or other requirements.

These resources are subject to change without notice. TI grants you permission to use these resources only for development of an application that uses the TI products described in the resource. Other reproduction and display of these resources is prohibited. No license is granted to any other TI intellectual property right or to any third party intellectual property right. TI disclaims responsibility for, and you will fully indemnify TI and its representatives against, any claims, damages, costs, losses, and liabilities arising out of your use of these resources.

TI's products are provided subject to [TI's Terms of Sale](#) or other applicable terms available either on [ti.com](https://www.ti.com) or provided in conjunction with such TI products. TI's provision of these resources does not expand or otherwise alter TI's applicable warranties or warranty disclaimers for TI products.

TI objects to and rejects any additional or different terms you may have proposed.

Mailing Address: Texas Instruments, Post Office Box 655303, Dallas, Texas 75265
Copyright © 2024, Texas Instruments Incorporated