



Supriyo Palit

Low-Power Audio

## ABSTRACT

The TAS2781 and TAS2783 are digital input Class-D smart audio amplifiers with speaker protection. The TAS2783 additionally supports the MIPI Alliance SoundWire interface with *SoundWire Device Class Audio* (SDCA). An on-chip low-latency digital-signal processor (DSP) supports advanced audio enhancement and speaker protection algorithms. The advanced audio enhancement algorithms improve audio quality, increase clarity, reduce noise, and provide rich bass, and dynamic playback. This document describes the various audio enhancement algorithms that are in the TAS2781 and TAS2783 amplifiers.

## Table of Contents

<b>1 Introduction</b> .....	2
<b>2 Volume Control</b> .....	2
<b>3 Equalizer</b> .....	3
3.1 Dynamic Equalization.....	4
<b>4 Dynamic Range Compressor (DRC)</b> .....	4
<b>5 Psycho-Acoustic Bass</b> .....	9
<b>6 Rattle Noise Suppressor</b> .....	10
<b>7 Revision History</b> .....	11

## List of Figures

Figure 1-1. Audio Enhancement Signal Chain.....	2
Figure 2-1. Volume Soft Stepping.....	3
Figure 2-2. Volume Control.....	3
Figure 3-1. Equalizer and High-Pass Filter Controls for Static Equalizer .....	3
Figure 3-2. Dynamic Equalization Functionality.....	4
Figure 3-3. Dynamic Equalization Controls.....	4
Figure 4-1. Basic DRC Functionality.....	5
Figure 4-2. Compressor.....	5
Figure 4-3. Expander .....	6
Figure 4-4. Noise Gate.....	6
Figure 4-5. Example DRC Plot .....	7
Figure 4-6. Time Constant Controls .....	7
Figure 4-7. Attack, Release Time Waveform .....	7
Figure 4-8. 3-Band DRC .....	8
Figure 4-9. Controls for DRC Regions.....	8
Figure 5-1. Psycho-Acoustic Bass Effect.....	9
Figure 5-2. Psycho-Acoustic Bass Controls.....	9
Figure 6-1. Rattle Noise Characteristics.....	10
Figure 6-2. Rattle Noise Suppressor Controls.....	10

## Trademarks

All trademarks are the property of their respective owners.

## 1 Introduction

The TAS2781 and TAS2783 devices are mono, digital input Class-D audio amplifiers optimized for efficiently driving high-peak power into small loudspeakers. The Class-D amplifier is capable of delivering 25 W of continuous power into a 4-Ω load with less than 1% THD+N at a supply voltage of 18 V. The broad voltage input range and the high output power makes this amplifier versatile enough to work with battery power or with line-powered systems. An on-chip low latency DSP supports Texas Instruments' SmartAmp speaker protection and audio enhancement algorithms. The integrated speaker voltage and current sense provides for real-time monitoring of loudspeakers, which permits pushing peak sound pressure levels (SPL) while keeping speakers from being damaged. The Y-Bridge power architecture improves amplifier efficiency by internally selecting the supplies for optimal headroom. The TAS2783 amplifier supports MIPI SoundWire v1.2, with SDCA.

The audio enhancement algorithms inside the TAS2781 and TAS2783 devices consist of volume control, equalizer filters, dynamic compressors, and some specialized functions such as psycho-acoustic bass enhancer, rattle noise suppressor, and posture control.

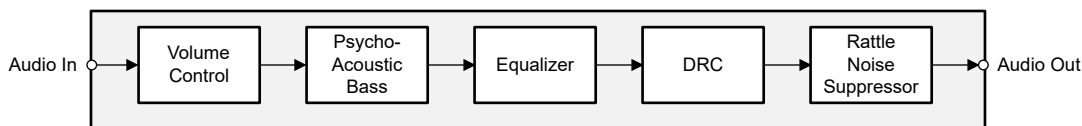

**Figure 1-1. Audio Enhancement Signal Chain**

The volume control is used to increase or decrease the intensity of the sound output. A soft ramp feature is supported so as to enable real-time updates without any audible distortion.

The equalizer filters are primarily used to provide a flat loudspeaker response and to extend the bass response.

The dynamic range compressors are used to compress loud signals and provide consistent loudness. The compressors use RMS-based signal-level tracking to control the power pumped into the speaker. The compressors can be applied at different audio frequency bands and can be independently configured.

The psycho-acoustic bass enhancer improves the bass perception by generating harmonics. The bass frequencies are removed to improve the efficiency of the loudspeaker but the bass perception remains the same due to the *missing fundamental* effect of psycho acoustics.

The rattle noise suppressor is a specialized algorithm that suppresses mechanical noise caused due to severe speaker rattle near resonance frequency.

## 2 Volume Control

The volume control block applies a gain to the input signal and also provides headroom for further audio processing. The purpose of the volume gain is to be consistently loud across all music genres and movies. When used in combination with dynamic range compressors the control makes soft music sound loud – which is especially important when playing audio in noisy environments specially in small speakers. Volume control also supports soft-stepping. A change in volume is applied using a smooth time profile to eliminate any artifacts.

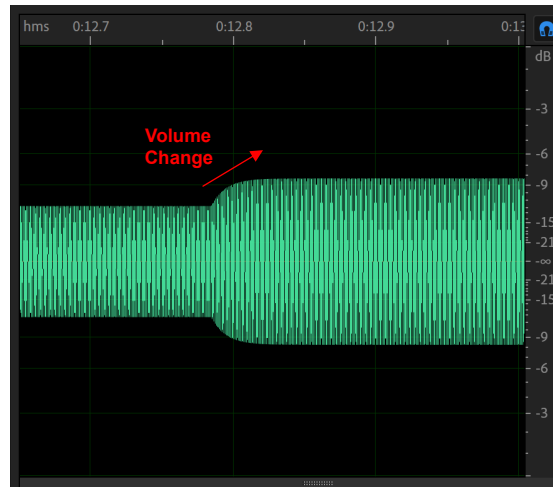

**Figure 2-1. Volume Soft Stepping**

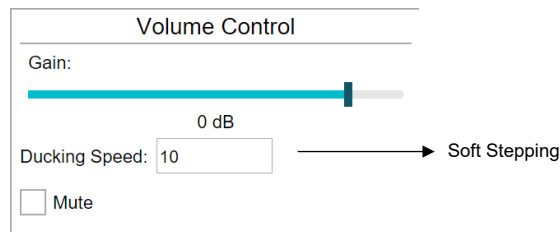

**Figure 2-2. Volume Control**

### 3 Equalizer

The equalizer filters are used to make the loudspeaker response flat and also to compensate for any non-linear distortion such as speaker rub-and-buzz.

The equalizer filters consist of multiple biquad filters allowing the following:

- Loudspeaker frequency response compensation
- Extend the bass response of the speaker
- Attenuate frequencies that produce high THD
- Remove dc signals or very low frequency signals that may cause speaker damage due to over excursion

The static filter chain consists of a 10-biquad equalizer filter module and a high-pass filter module.

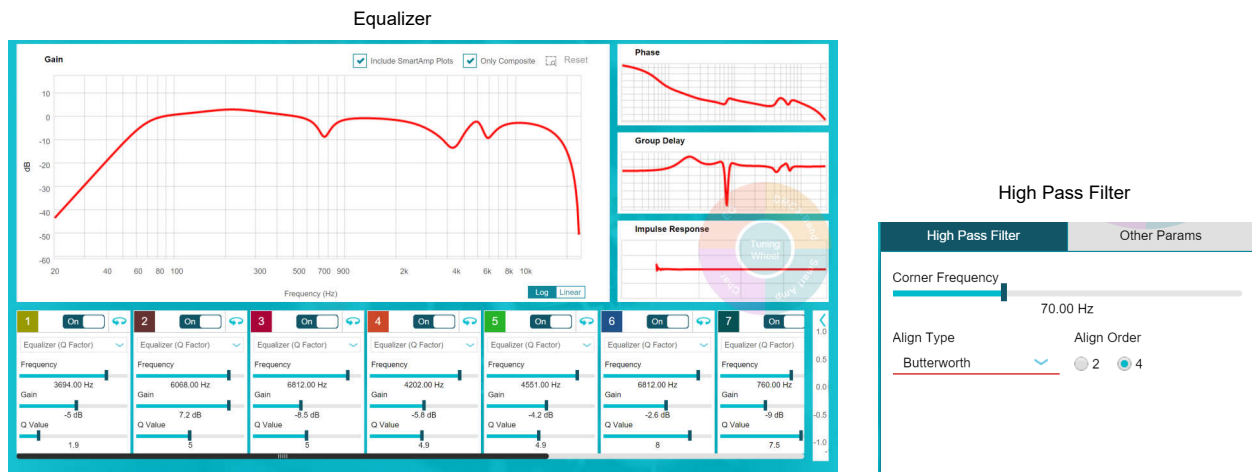

**Figure 3-1. Equalizer and High-Pass Filter Controls for Static Equalizer**

The High-Pass filter module removes dc signals. The corner frequency, order of the filter, and the type of filter are programmable.

The equalizer filter consists of 10-biquad filters. Each filter can be programmed with different filter types (high pass, low pass, equalizer, and so forth) and with different parametric options (corner frequency, bandwidth, gain, Q-factor, and so forth).

### 3.1 Dynamic Equalization

The equalization signal chain also supports dynamic equalization. Dynamic equalization is a feature where only large level signals are attenuated to prevent distortion but small signals are passed without any modification to the signal level. Most of the non-linear distortion in loudspeakers such as rub-and-buzz, sibilance noise and rocking modes are observed only at large signal levels. It is not necessary to apply any filtering at small signal levels. This increases the overall loudness of the audio signal while at the same time preventing audio artifacts. The equalization is applied at a particular frequency only if the signal level at that frequency exceeds a certain threshold. Once the dynamic equalizer is engaged, the signal is attenuated by the desired range so that the signal level is always maintained at the target threshold level. There are two dynamic equalizers available – each at a distinct programmable frequency point. Usually a low frequency dynamic equalizer is used to control rub-and-buzz distortion near the loudspeaker resonance region. A high frequency dynamic equalizer is used for rocking mode or sibilance control near the voicing region.

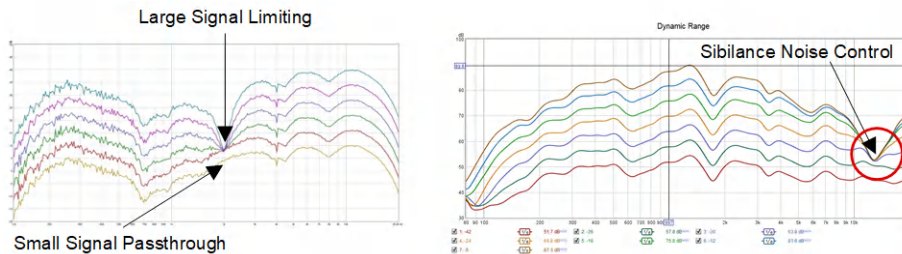

**Figure 3-2. Dynamic Equalization Functionality**

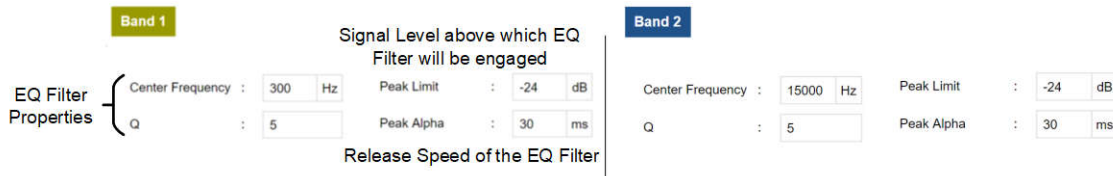

**Figure 3-3. Dynamic Equalization Controls**

## 4 Dynamic Range Compressor (DRC)

The dynamic range of an audio signal is the ratio of the loudest signal to the quietest signal. For a loudspeaker, the rated power and the peak excursion restricts the maximum output signal and the noise floor determines the minimum output signal. As a result, it is necessary to apply controls in a signal processor to adjust the level of the audio signal to match the dynamic range of the loudspeaker. Typically, the dynamic range of the loudspeaker is limited and hence there is a compression (or overall reduction) of dynamic range. To increase the loudness, dynamic range compressors further reduce the dynamic range by amplifying soft signals.

Dynamic range compressors alter the audio signal based on frequency content and signal level. The compressors have a gain control element in the main signal path and a side-chain containing a detector and a gain computer. The detector tracks the signal level and the gain computer alters the gain of the main signal path based on the signal level. The side-chain activity is governed by five primary parameters – threshold, offset, ratio, attack, and release. If the signal level is above the threshold, the gain is altered using the ratio and offset parameter. The ratio determines the slope while the offset determines the starting point for the gain when the signal level is above the threshold. The alteration of gain is controlled in time using attack and release controls. The slope is the inverse of the ratio parameter.

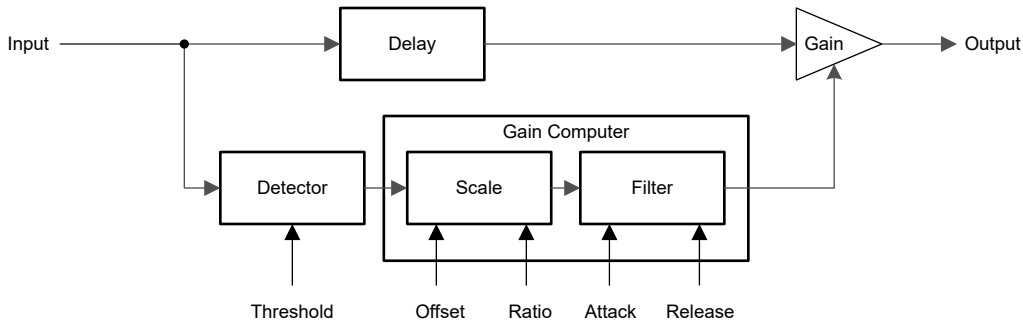

Figure 4-1. Basic DRC Functionality

A compressor reduces the dynamic range by turning down the loudest signal dynamically, that is, the compressor makes loud sounds quieter. The compressor achieves this by making the increase in signal levels smaller by reducing the gain for signals above the threshold. The ratio parameter for the compressor is always greater than 1 (that is, slope < 1).

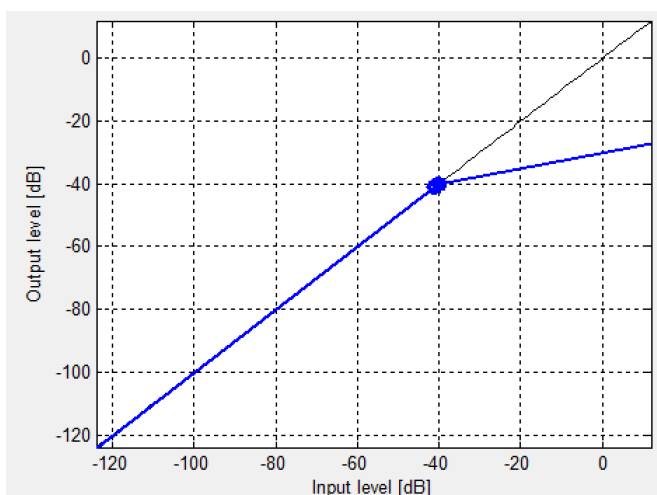
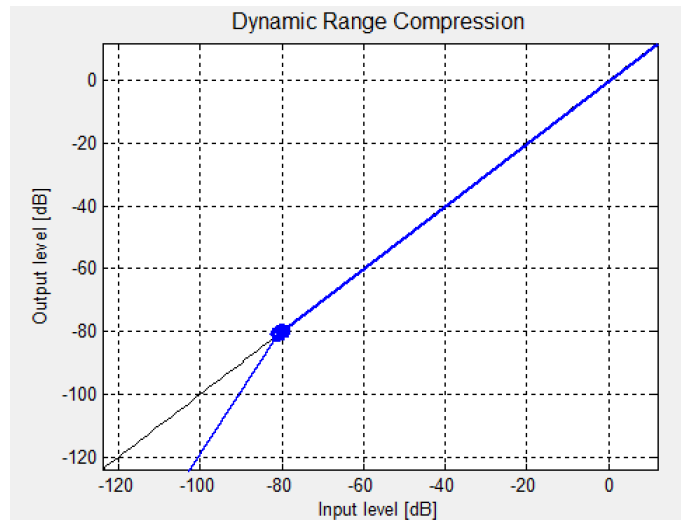

Figure 4-2. Compressor

Conversely, an expander increases the dynamic range of the signal passing through and the expander makes quiet parts of sound quieter. The expander achieves this by making the reduction of signal levels larger by reducing the gain for signals below the threshold. The most common use of the expander is noise reduction – as the sound becomes quieter and closer to the noise floor, the expander reduces the signal further resulting in an improvement in noise reduction. The ratio parameter for the expander is always less than 1 (that is, slope > 1).



**Figure 4-3. Expander**

Typically, signals are expanded at low levels (to reduce noise) but compressed at high levels (to prevent amplifier clipping).

The dynamic range compressor also supports a noise-gate feature. Unlike the expander, the noise-gate applies a fixed gain (that is, attenuation) to the audio signal when the signal is below a certain threshold. This is over and above the typical expansion gain applied for low signal levels. The noise gate is typically used to remove background noise between louder sounds.

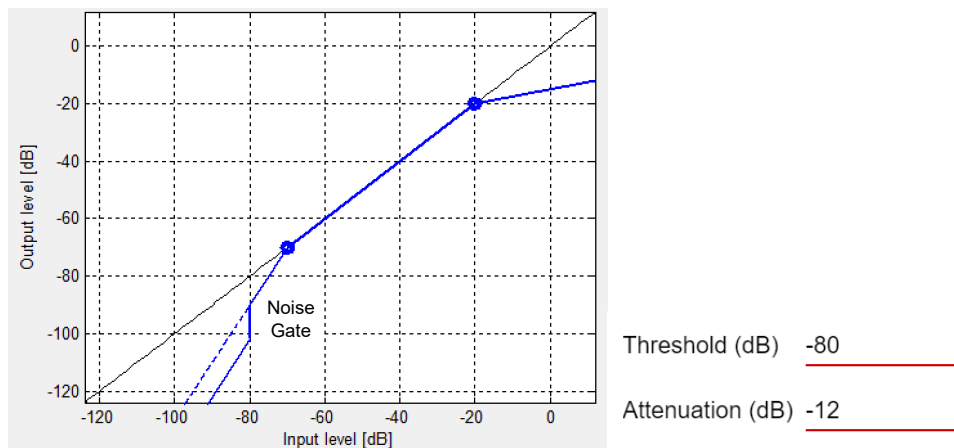

**Figure 4-4. Noise Gate**

The threshold is the beginning of gain adjustment. When the input is below the threshold for compressors, or above the threshold for expanders, typically the dynamic processor does not engage. When the input is above the threshold (compression) or below the threshold (expansion), the side-chain asserts itself and reduces the volume.

The detector threshold is RMS energy based. RMS energy-based detectors maintain dynamic range based on the power handling capability of the loudspeaker. An averaging time constant is used to determine RMS of the input signal. This is known as the energy time constant.

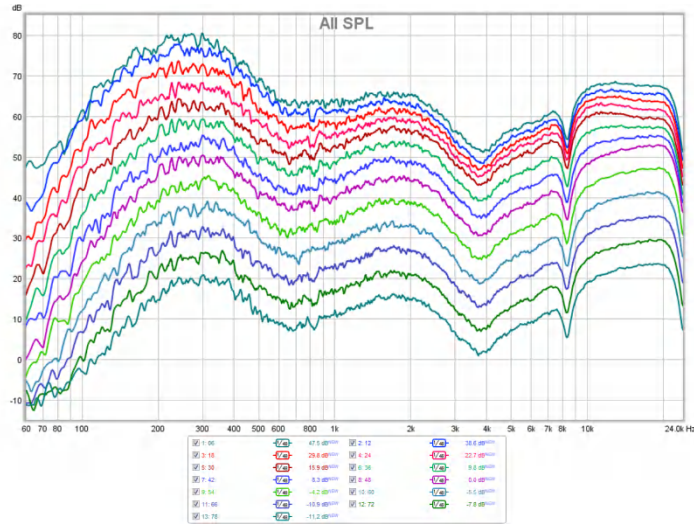

**Figure 4-5. Example DRC Plot**

The time required for the compressor to react to an increase in side-chain input level above the threshold is called the attack, that is, this defines how quickly the gain is turned down. Conversely, when the side-chain input level falls below the threshold, the time taken to turn the gain back up is called release. Both attack and release are defined by a time constant resulting in a constant dB-per-second gain change at the output.

Attack (ms)      250

Release (ms)    2000

Energy (ms)     1000

**Figure 4-6. Time Constant Controls**

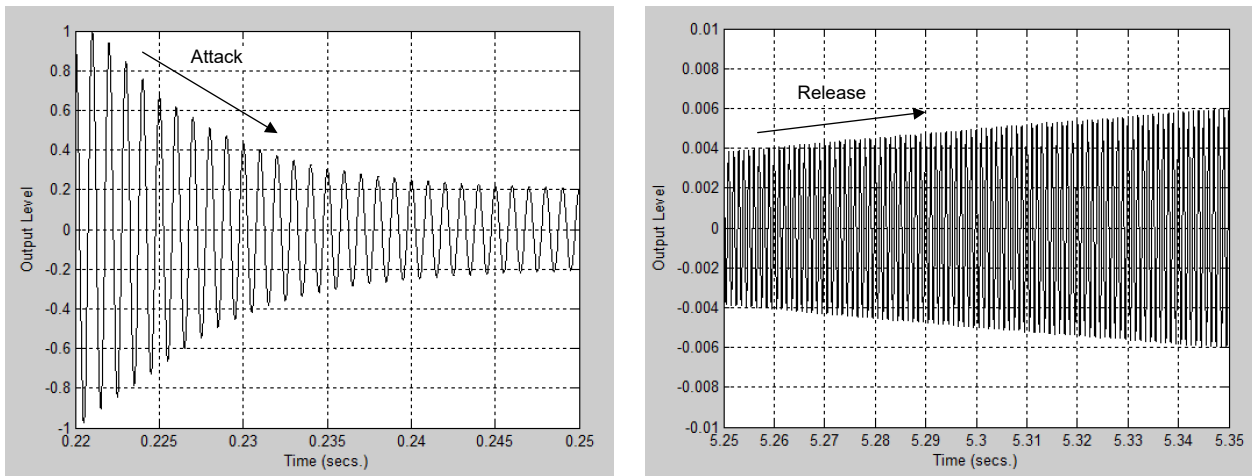

**Figure 4-7. Attack, Release Time Waveform**

There are three dynamic range compressors available – each can be programmed to cover a certain audio frequency range. The three dynamic compressors (known as the 3-band DRC), each independently programmable, covers the entire audio range from 20 Hz to 20 kHz using a three-band linked crossover network. These DRCs use an RMS-based detector.

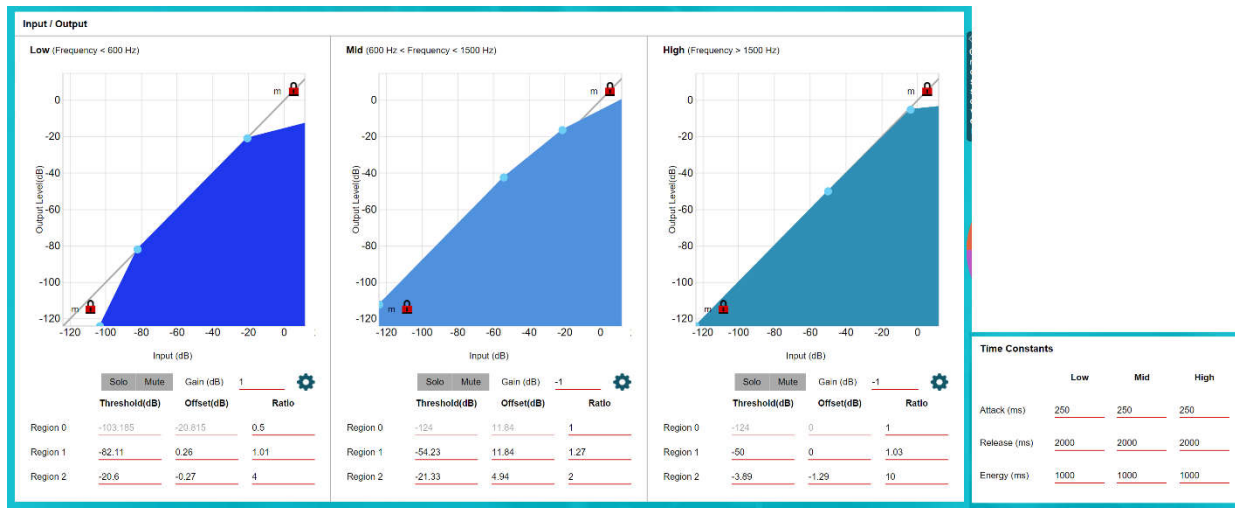

**Figure 4-8. 3-Band DRC**

Each compressor has three regions for signal-level control – low-signal region, mid-signal region, and high-signal region – with the threshold, offset, and ratio (compression or expansion) for each region being programmed. The attack and release are the same across all regions. The side-chain input level is compared with each threshold to determine the signal region and accordingly the ratio, is used by the gain computer to apply the gain in the main signal path.

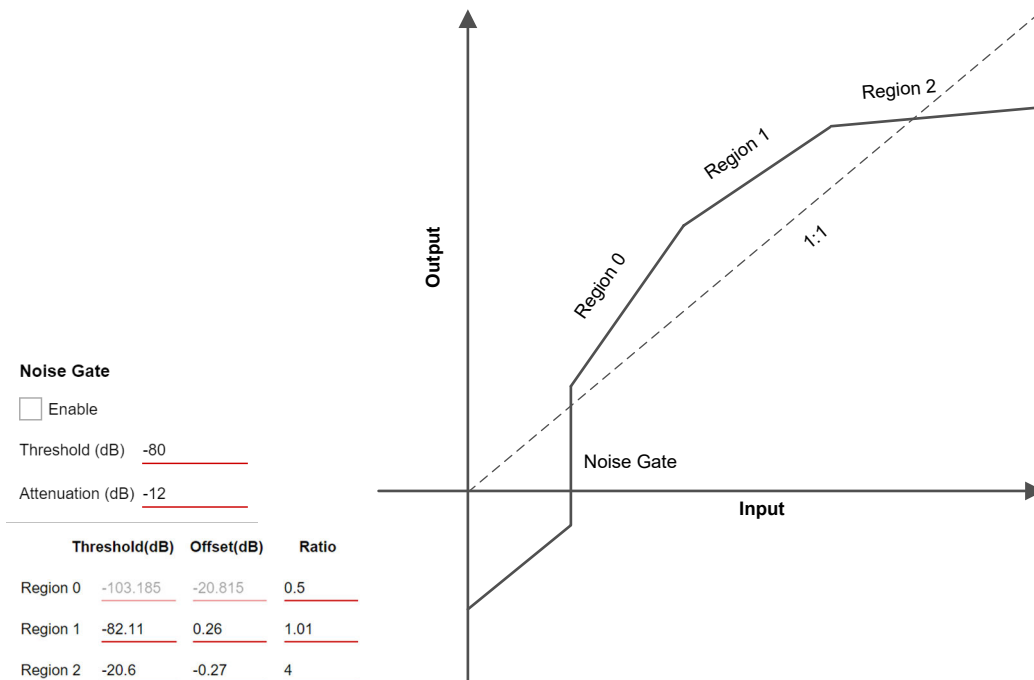
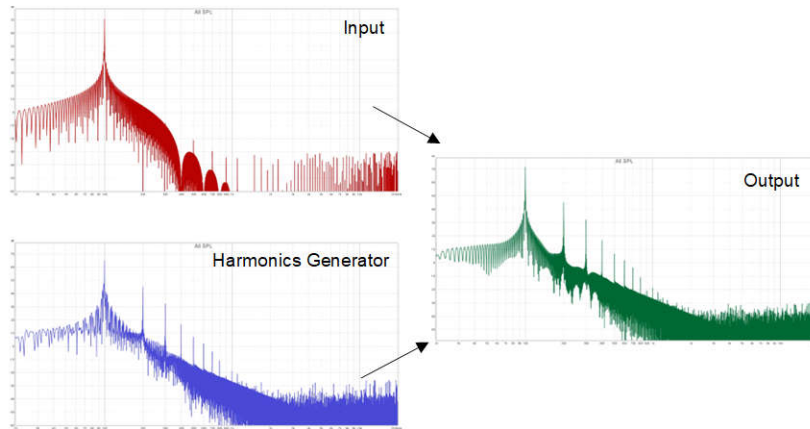

**Figure 4-9. Controls for DRC Regions**



## 5 Psycho-Acoustic Bass

The psycho-acoustic bass module simulates deep bass on small speakers by generating harmonics. This improves the bass response on small speakers and also improves power efficiency. The fundamental bass frequencies can be attenuated and removed by the equalizer filters, but the bass is still perceived due to the presence of the harmonics even if the fundamentals are missing. This helps maintain the same level of bass at lower power levels or a higher perceived bass at a given power level, because a loudspeaker is more efficient in generating a high-frequency sound compared to a low-frequency sound.



**Figure 5-1. Psycho-Acoustic Bass Effect**

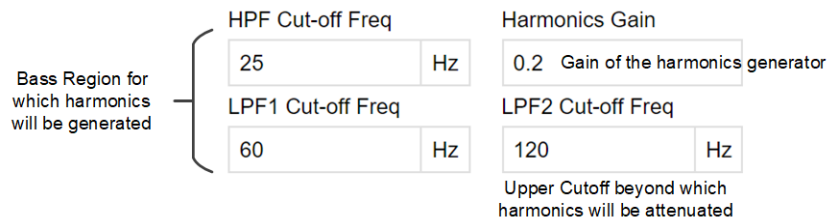

**Figure 5-2. Psycho-Acoustic Bass Controls**

## 6 Rattle Noise Suppressor

The rattle noise suppressor is a special purpose frequency sensitive compressor that reduces rattle noise. When loudspeakers are driven hard near the resonance frequency of the speaker, the mechanical movement of the diaphragm causes air turbulence through the firing ports and results in high-frequency rattle noise. The threshold of the compressor depends on the signal level at which the rattle noise is produced. If rattle noise is produced at low signal levels near the resonance frequency then the threshold has to be lowered and vice versa. Only the audio signal near the resonance frequency needs to be suppressed, hence the compressor is applied around the frequency region near resonance. The compressor is typically used as a limiter to keep the signal level close to the threshold limit. The side-chain detector also analyzes energy levels in both the resonance region and the high-frequency region. The detector analyzes the energy levels to determine the severity of rattle noise and activates the compressor only if the high-frequency energy does not exceed the resonance energy by a certain level. The resonance region, the high-frequency region, and the level are all programmable.

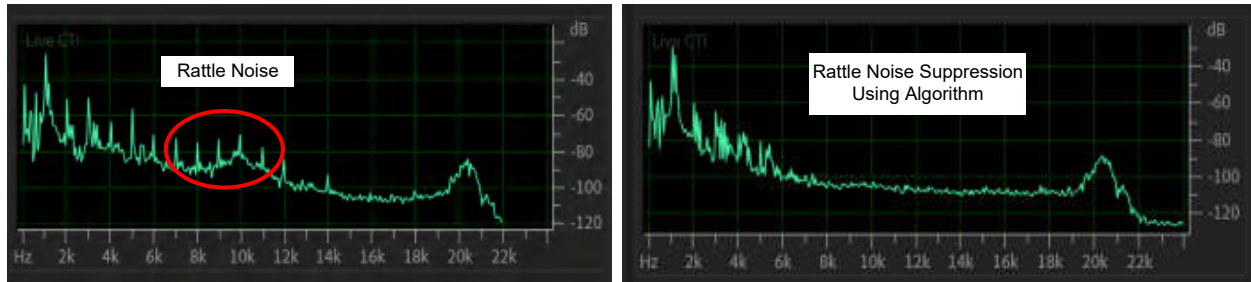

**Figure 6-1. Rattle Noise Characteristics**

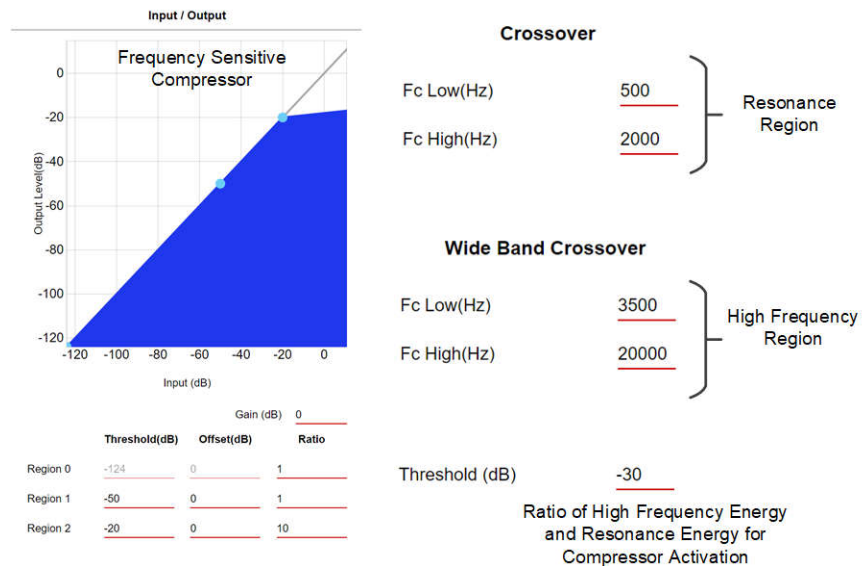

**Figure 6-2. Rattle Noise Suppressor Controls**

## 7 Revision History

<b>Changes from Revision * (August 2022) to Revision A (April 2024)</b>	<b>Page</b>
• Updated the numbering format for tables, figures, and cross-references throughout the document.....	<a href="#">1</a>
• Added Dynamic Equalization topic.....	<a href="#">4</a>

## IMPORTANT NOTICE AND DISCLAIMER

TI PROVIDES TECHNICAL AND RELIABILITY DATA (INCLUDING DATA SHEETS), DESIGN RESOURCES (INCLUDING REFERENCE DESIGNS), APPLICATION OR OTHER DESIGN ADVICE, WEB TOOLS, SAFETY INFORMATION, AND OTHER RESOURCES "AS IS" AND WITH ALL FAULTS, AND DISCLAIMS ALL WARRANTIES, EXPRESS AND IMPLIED, INCLUDING WITHOUT LIMITATION ANY IMPLIED WARRANTIES OF MERCHANTABILITY, FITNESS FOR A PARTICULAR PURPOSE OR NON-INFRINGEMENT OF THIRD PARTY INTELLECTUAL PROPERTY RIGHTS.

These resources are intended for skilled developers designing with TI products. You are solely responsible for (1) selecting the appropriate TI products for your application, (2) designing, validating and testing your application, and (3) ensuring your application meets applicable standards, and any other safety, security, regulatory or other requirements.

These resources are subject to change without notice. TI grants you permission to use these resources only for development of an application that uses the TI products described in the resource. Other reproduction and display of these resources is prohibited. No license is granted to any other TI intellectual property right or to any third party intellectual property right. TI disclaims responsibility for, and you will fully indemnify TI and its representatives against, any claims, damages, costs, losses, and liabilities arising out of your use of these resources.

TI's products are provided subject to [TI's Terms of Sale](#) or other applicable terms available either on [ti.com](https://www.ti.com) or provided in conjunction with such TI products. TI's provision of these resources does not expand or otherwise alter TI's applicable warranties or warranty disclaimers for TI products.

TI objects to and rejects any additional or different terms you may have proposed.

Mailing Address: Texas Instruments, Post Office Box 655303, Dallas, Texas 75265  
Copyright © 2024, Texas Instruments Incorporated