

# TPS56339 Step-Down Converter Evaluation Module User's Guide



## ABSTRACT

This user's guide contains background information for the TPS56339 as well as support documentation for the TPS56339EVM evaluation module. Included are the performance specifications, the schematic, and the list of materials for the TPS56339EVM.

## Table of Contents

<b>1 Introduction</b>	3
<b>2 Performance Specification Summary</b>	4
<b>3 Modifications</b>	5
3.1 Output Voltage Set Point	5
3.2 Adjustable UVLO	6
<b>4 EVM Photos</b>	7
<b>5 Test Setup and Results</b>	8
5.1 Input/Output Connections	8
5.2 Start-Up Procedure	8
5.3 Efficiency	8
5.4 Output Voltage Load Regulation	9
5.5 Output Voltage Line Regulation	10
5.6 Load Transients	10
5.7 Voltage Ripple	11
5.8 Powering Up	12
5.9 Powering Down	13
5.10 Output Short Protection and Recovery	14
5.11 Thermal Performance	14
<b>6 Board Layout</b>	16
6.1 Layout	16
<b>7 Schematic and List of Materials</b>	18
7.1 Schematic	18
7.2 List of Materials	19
<b>8 Revision History</b>	20

## List of Figures

Figure 4-1. TPS56339EVM Front Photo	7
Figure 4-2. TPS56339EVM Back Photo	7
Figure 5-1. TPS56339EVM Efficiency	9
Figure 5-2. TPS56339EVM Low Current Efficiency	9
Figure 5-3. TPS56339EVM Load Regulation	10
Figure 5-4. TPS56339EVM Line Regulation	10
Figure 5-5. TPS56339EVM Transient Response 1.5 to 3 A	11
Figure 5-6. TPS56339EVM Transient Response 0.3 to 2.7 A	11
Figure 5-7. TPS56339EVM Output Ripple, $I_{OUT} = 3$ A	11
Figure 5-8. TPS56339EVM Output Ripple, $I_{OUT} = 0.3$ A	12
Figure 5-9. TPS56339EVM Output Ripple, $I_{OUT} = 0$ A	12
Figure 5-10. TPS56339EVM Startup Relative to $V_{IN}$	12
Figure 5-11. TPS56339EVM Startup Relative to Enable	13
Figure 5-12. TPS56339EVM Shutdown Relative to $V_{IN}$	13
Figure 5-13. TPS56339EVM Shutdown Relative to EN	13
Figure 5-14. TPS56339EVM Short Protection	14

Figure 5-15. TPS56339EVM Short Recovery.....	14
Figure 5-16. TPS56339EVM Thermal Performance.....	15
Figure 6-1. Top Assembly.....	16
Figure 6-2. Top Layer.....	16
Figure 6-3. Bottom Layer.....	17
Figure 7-1. TPS56339EVM Schematic.....	18

### List of Tables

Table 1-1. Input Voltage and Output Current Summary.....	3
Table 2-1. TPS56339EVM Performance Specification Summary.....	4
Table 3-1. Recommended Component Values.....	6
Table 5-1. EVM Connectors and Test Points.....	8
Table 7-1. TPS56339EVM List of Materials.....	19

### Trademarks

All trademarks are the property of their respective owners.

## 1 Introduction

The TPS56339 is a single, Advanced Emulated Current Mode (AECM) control, synchronous Buck DC/DC converter, being able to deliver 3-A continuous output current, providing an advance Eco-mode to maintain high light load efficiency. The TPS56339 integrates 26-V capable MOSFETs which is suitable for applications working from 19-V bus power lines. The device implements an AECM control which can get fast transient response with fixed frequency. The fast transient response results in low voltage drop and the fixed frequency brings a better jitter permanence and predictable frequency for EMI design. The optimized internal compensation network minimizes the external component counts and simplifies the control loop design over a wide voltage output range. [Table 1-1](#) shows the rated input voltage and output current ranges for the evaluation module.

The TPS56339EVM is a single, synchronous buck converter providing 5 V at 3 A from 5.5 V to 24 V input. This user's guide describes the TPS56339EVM performance.

**Table 1-1. Input Voltage and Output Current Summary**

EVM	Input Voltage Range	Output Current Range
TPS56339EVM	$V_{IN} = 5.5V$ to 24 V	0 A to 3 A

## 2 Performance Specification Summary

A summary of the TPS56339EVM performance specifications is provided in [Table 2-1](#). Specifications are given for an input voltage of  $V_{IN} = 19\text{ V}$  and an output voltage of 5.0 V, unless otherwise specified. The TPS56339EVM is designed and tested for  $V_{IN} = 5.5\text{ V}$  to 24 V. The ambient temperature is 25°C for all measurements, unless otherwise noted.

**Table 2-1. TPS56339EVM Performance Specification Summary**

Specification	Test Conditions	MIN	TYP	MAX	Unit
Input voltage range		5.5	19	24	V
$V_{START}$ Input start voltage			6.6		V
$V_{STOP}$ Input stop voltage			5.7		V
Output voltage set point			5		V
Output current range	$V_{IN} = 6\text{ V}$ to 24 V	0		3	A
Line regulation	$I_O = 3\text{ A}$		±0.5%		
Load regulation	$V_{IN} = 19\text{ V}$		±0.5%		
Output ripple voltage	$V_{IN} = 19\text{ V}$ , $I_O = 3\text{ A}$		<30		mV <sub>pp</sub>
Center operating frequency			500		kHz
Maximum Efficiency	$V_{IN} = 19\text{ V}$ , $I_O = 3\text{ A}$		94.0%		

### 3 Modifications

These evaluation modules are designed to provide access to the features of the TPS56339. Some modifications can be made to this module.

#### 3.1 Output Voltage Set Point

The voltage divider, R6 and R7, is used to set the output voltage. To change the output voltage of the EVM, it is necessary to change the value of resistor R6. Changing the value of R6 can change the output voltage above 0.8 V. The value of R6 for a specific output voltage can be calculated using [Equation 1](#). Use 10 kΩ for R7.

$$R_6 = \left( \frac{V_{OUT}}{0.8} - 1 \right) \cdot R_7 \quad (1)$$

[Table 3-1](#) lists the R6 and R7 values for some common output voltages. Note that  $V_{IN}$  must be in a range so that the minimum on-time is greater than 55 ns. The values in [Table 3-1](#) are standard values, not the exact value calculated using [Equation 1](#).

Be noted that the voltage rate of the output capacitors is only 16 VDC, higher voltage rate capacitors should be used when the configured output voltage is equal or higher than 12V.

**Table 3-1. Recommended Component Values**

OUTPUT VOLTAGE <sup>(1)</sup> (V)	R6 <sup>(2)</sup> (kΩ)	R7 (kΩ)	L1 <sup>(3)</sup> (μH)	C <sub>OUT</sub> <sup>(4)</sup> (μF)	Range of L1·C <sub>OUT_E</sub> <sup>(5)</sup> (μH×μF)
1.05	3.16	10.0	1.5	2×22	48 to 188
1.8	12.4	10.0	2.2	2×22	64 to 250
2.5	21.5	10.0	3.3	2×22	87 to 334
3.3	31.6	10.0	4.7	2×22	107 to 404
5	52.3	10.0	5.6	2×22	93 to 334
12	140	10.0	6.8	3×22	45 to 137

- (1) Please use the recommended L1 and C<sub>OUT</sub> combination of the higher and closest output rail for the unlisted output rails.
- (2) R6 = 0 Ω for V<sub>OUT</sub> = 0.8 V.
- (3) Inductance values are calculated based on V<sub>IN</sub> = 19 V, but they can also be used for other input voltages. User can calculate their preferred inductance value per TPS56339 datasheet.
- (4) The C<sub>OUT</sub> is the sum of nominal output capacitance. Two 22-μF, 0805, 16VDC capacitors are recommended for V<sub>OUT</sub> ≤ 5V, three 22-μF, 0805, 25VDC capacitors are recommended for V<sub>OUT</sub> > 5V.
- (5) The C<sub>OUT\_E</sub> is the effective value after derating, the value of L1·C<sub>OUT\_E</sub> should be within in the range.

### 3.2 Adjustable UVLO

The under voltage lock out (UVLO) can be adjusted externally using R1 and R2. The EVM is set for a start voltage of 6.6 V and a stop voltage of 5.7 V using R1 = 174 kΩ and R2 = 36.5 kΩ. Use [Equation 2](#) and [Equation 3](#) to calculate required resistor values for different start and stop voltages. For higher light-load efficiency, consider choosing a larger R1 and R2. Make adjustments to V<sub>start</sub> or V<sub>stop</sub> for a proper R1. Once R1, R2 settled down, the V<sub>EN</sub> voltage need to be calculated by [Equation 4](#) to make sure that it is lower than 5.5V with max V<sub>IN</sub>, max I<sub>p</sub> and max I<sub>h</sub>.

$$R_1 = \frac{V_{SATART} \frac{V_{EN\_FALL}}{V_{EN\_RISE}} - V_{STOP}}{I_p \left( 1 - \frac{V_{EN\_FALL}}{V_{EN\_RISE}} \right) + I_h} \quad (2)$$

$$R_2 = \frac{R_1 \cdot V_{EN\_FALL}}{V_{STOP} - V_{EN\_FALL} + R_1 \cdot (I_p + I_h)} \quad (3)$$

$$V_{EN} = \frac{R_2 \cdot V_{IN} + R_1 R_2 (I_p + I_h)}{R_1 + R_2} \quad (4)$$

where

- I<sub>p</sub> = 1.2 μA
- I<sub>h</sub> = 3.1 μA
- V<sub>ENfalling</sub> = 1.12 V
- V<sub>ENrising</sub> = 1.18 V

## 4 EVM Photos

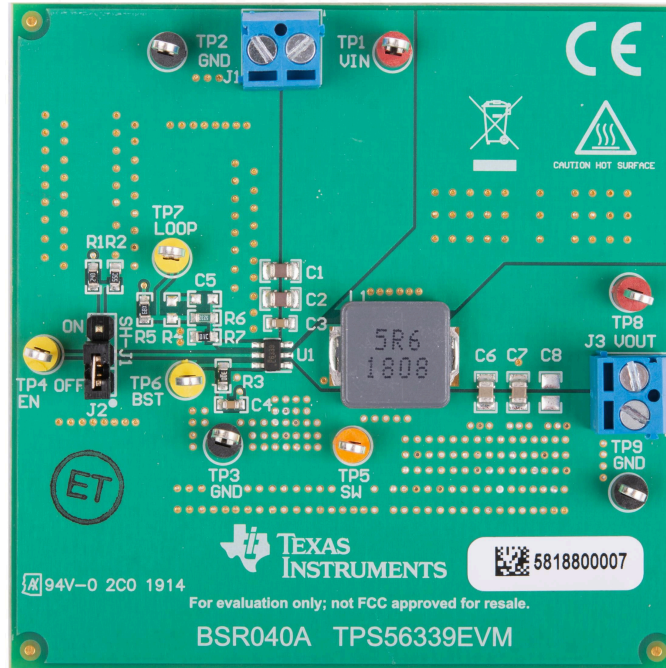

Figure 4-1. TPS56339EVM Front Photo

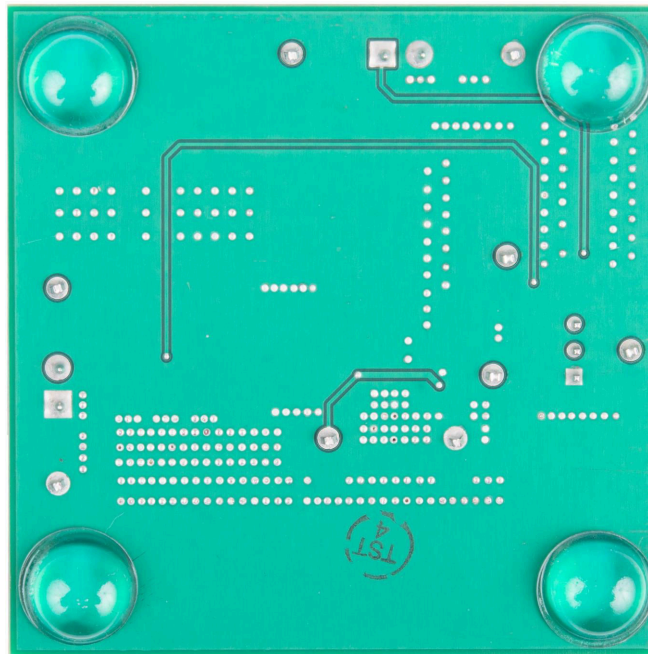

Figure 4-2. TPS56339EVM Back Photo

## 5 Test Setup and Results

This section describes how to properly connect, set up, and use the TPS56339EVM evaluation module. The section also includes test results typical for the evaluation module and covers efficiency, output voltage regulation, output line regulation, load transient response, output ripple, input ripple, start-up, output short and thermal performance. All the data and waveforms are tested under  $V_{IN} = 19\text{ V}$  unless otherwise stated.

### 5.1 Input/Output Connections

The TPS56339EVM is provided with input/output connectors and test points as shown in [Table 5-1](#). A power supply capable of supplying 3 A must be connected to J1 through a pair of 20-AWG wires. The load must be connected to J3 through a pair of 20-AWG wires. The maximum load current capability must be at least 3 A to use the full capability of this EVM. Wire lengths must be minimized to reduce losses in the wires. Test-point TP1 provides a place to monitor the  $V_{IN}$  input voltages with TP2 providing a convenient ground reference. TP8 is used to monitor the output voltage with TP9 as the ground reference.

**Table 5-1. EVM Connectors and Test Points**

Reference Designator	Function
J1	VIN (see <a href="#">Table 1-1</a> for $V_{IN}$ range)
J3	VOOUT, 5 V at 3 A maximum
J2	3-pin header for enable. Connect Pin2 to Pin1 to disable, Connect Pin2 to Pin3 to enable by resistor network, open to enable by EN floating.
TP1	$V_{IN}$ test point at VIN connector
TP2	GND test point at VIN connector
TP3	GND test point
TP4	EN test point
TP5	SW test point
TP6	Boot test point
TP7	Test point between voltage divider network and output. Used for loop response measurements.
TP8	Output voltage test point at VOOUT connector
TP9	GND test point at VOOUT connector

### 5.2 Start-Up Procedure

1. Ensure that the jumper at J2 (Enable control) pins 1 and 2 are covered to shunt EN to GND, disabling the output.
2. Apply appropriate VIN voltage to VIN (J1-1) and GND (J1-2).
3. Move the jumper at J2 (Enable control) away from pins 1 and 2 (EN and GND) or move the jumper at J2 from pin 1 and pin 2 to pin 2 and pin3 to enable the output.

### 5.3 Efficiency

The efficiency of this EVM peaks at a load current of about 0.5 A – 1 A, and then decreases as the load current increases towards full load. [Figure 5-1](#) shows the efficiency for the TPS56339EVM at an ambient temperature of 25 °C. [Figure 5-2](#) shows the efficiency for the TPS56339EVM on a semi-log scale to better show light load efficiency.

The efficiency may be lower at higher ambient temperatures, due to temperature variation in the drain-to-source resistance of the internal MOSFET.



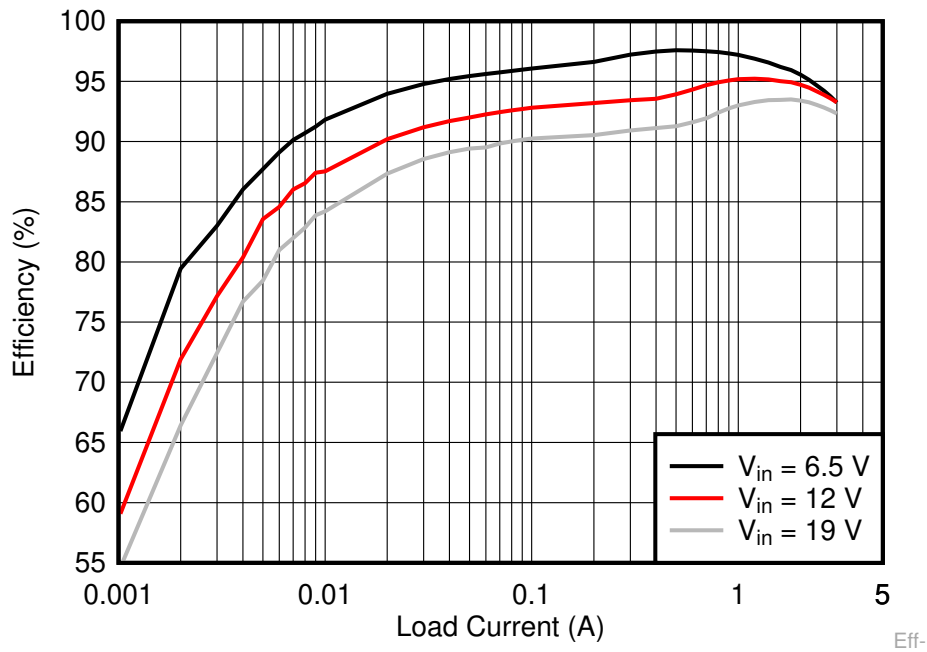

Figure 5-1. TPS56339EVM Efficiency

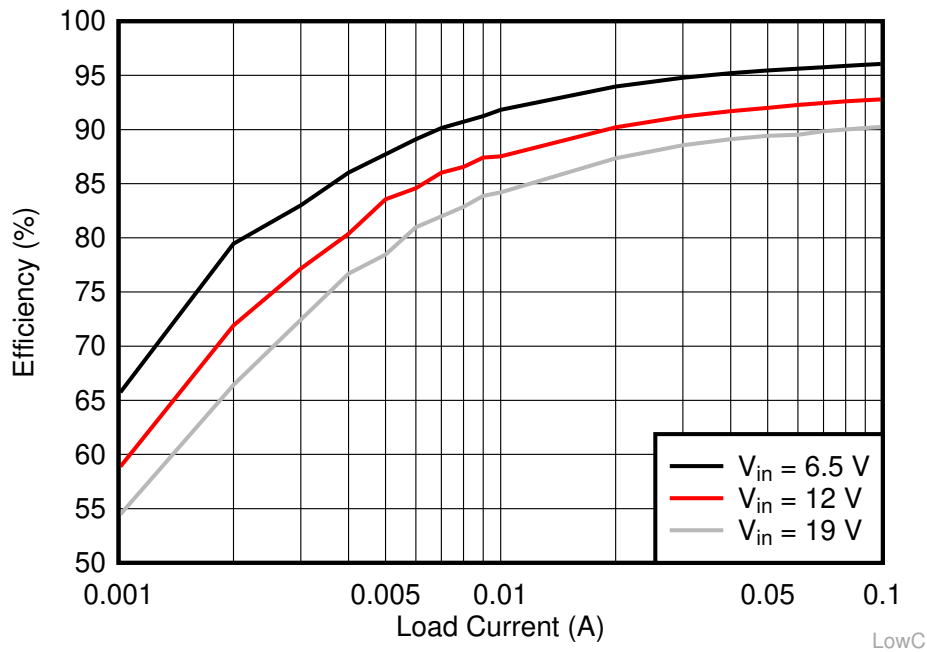

Figure 5-2. TPS56339EVM Low Current Efficiency

### 5.4 Output Voltage Load Regulation

Figure 5-3 shows the load regulation for the TPS56339EVM. Measurements are given for an ambient temperature of 25 °C.

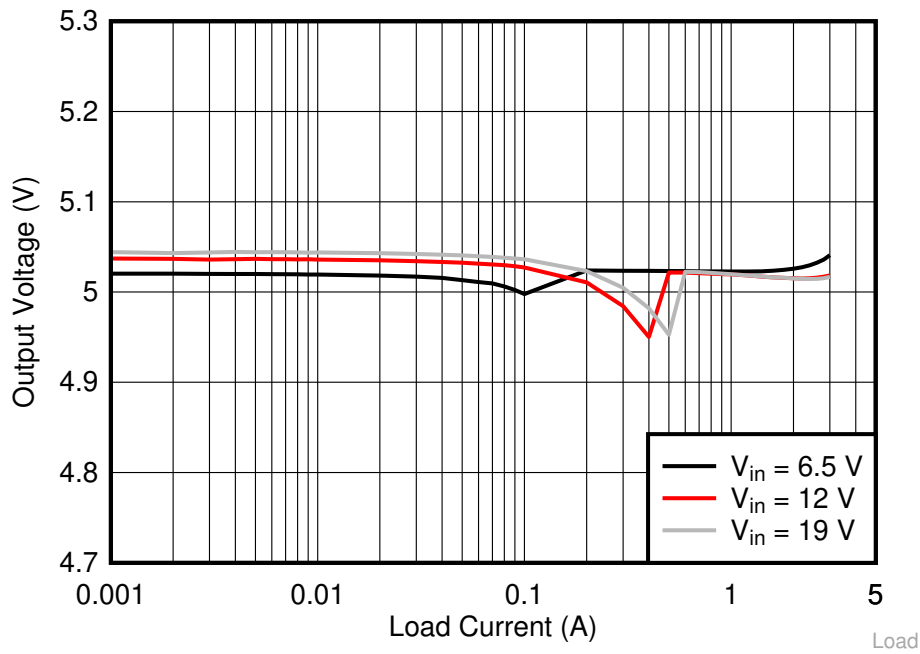

Figure 5-3. TPS56339EVM Load Regulation

### 5.5 Output Voltage Line Regulation

Figure 5-4 shows the line regulation for the TPS56339EVM.

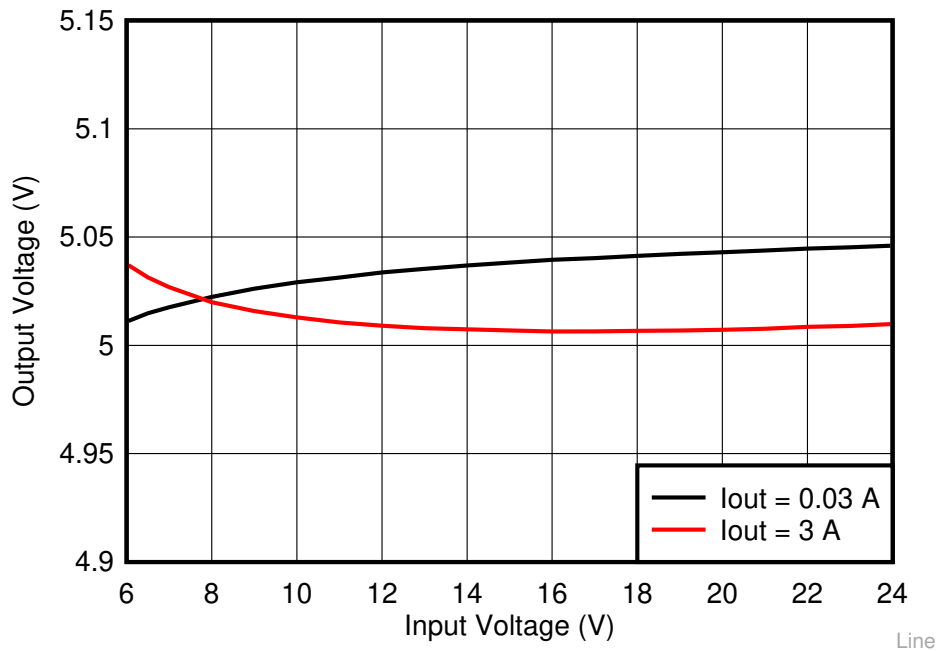
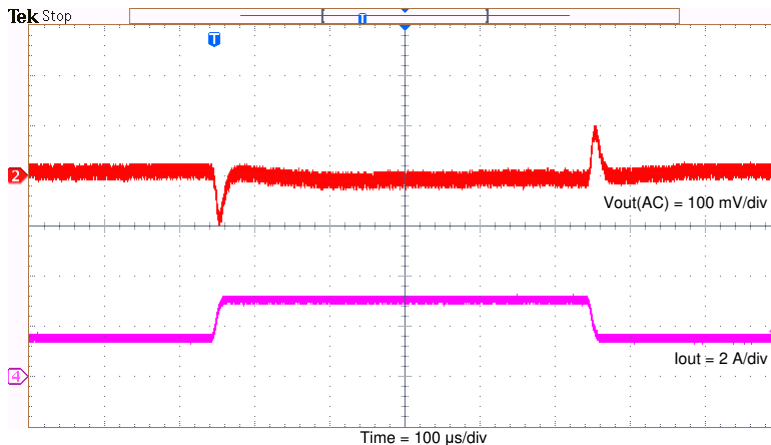

Figure 5-4. TPS56339EVM Line Regulation

### 5.6 Load Transients

Figure 5-5 and Figure 5-6 show the TPS56339EVM response to load transients. Total peak-to-peak voltage variation is as shown, including ripple and noise on the output.



**Figure 5-5. TPS56339EVM Transient Response 1.5 to 3 A**

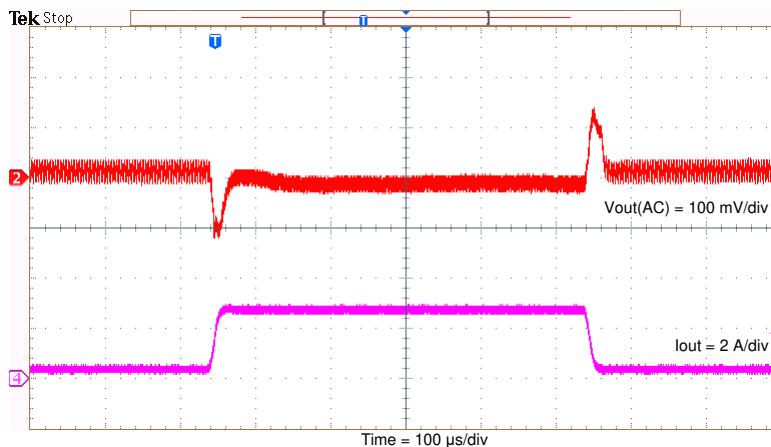

**Figure 5-6. TPS56339EVM Transient Response 0.3 to 2.7 A**

### 5.7 Voltage Ripple

Figure 5-7, Figure 5-8 and Figure 5-9 show the TPS56339EVM output voltage ripple for full-load, skip-mode, light-load and no-load operation.  $V_{IN} = 19\text{ V}$ . The output The ripple voltage is measured directly across the output capacitors.

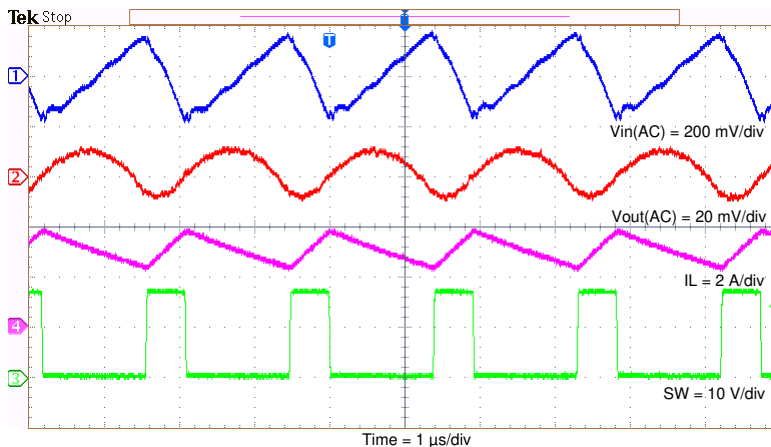

**Figure 5-7. TPS56339EVM Output Ripple,  $I_{OUT} = 3\text{ A}$**

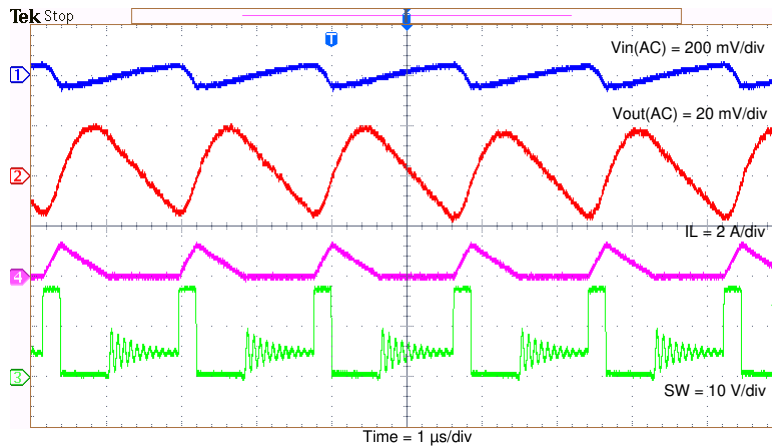

Figure 5-8. TPS56339EVM Output Ripple,  $I_{OUT} = 0.3 \text{ A}$

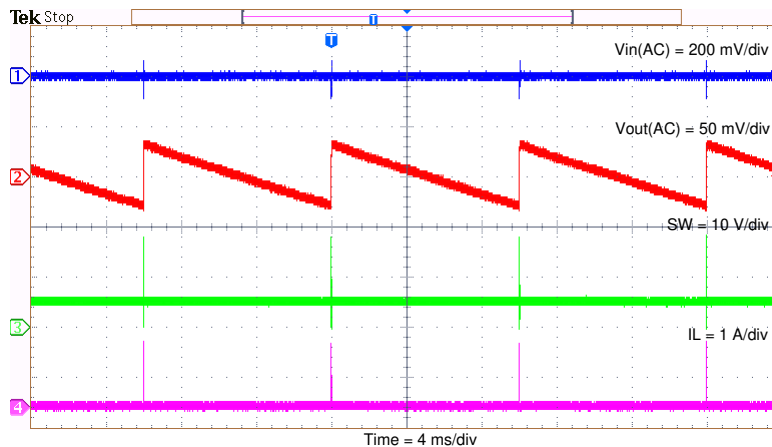

Figure 5-9. TPS56339EVM Output Ripple,  $I_{OUT} = 0 \text{ A}$

## 5.8 Powering Up

Figure 5-10 and Figure 5-11 show the start-up waveforms for the TPS56339EVM. In Figure 5-10, the output voltage ramps up as soon as the input voltage reaches the UVLO threshold as set by the R1 and R2 resistor divider network. In Figure 5-11, the input voltage is initially applied and the output is inhibited by using a 3.3-V logic signal between EN and GND. When the EN voltage reaches the enable-threshold voltage, the start-up sequence begins and the output voltage ramps up to the externally set value of 5 V. The input voltage for these plots is 19 V and the load current is 3 A.

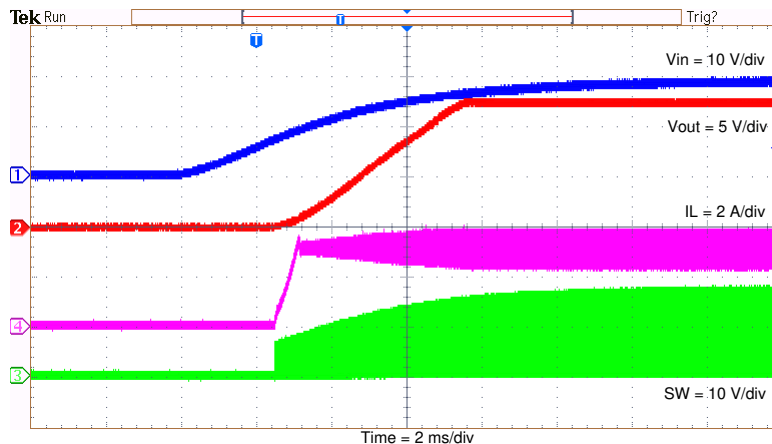

Figure 5-10. TPS56339EVM Startup Relative to  $V_{IN}$

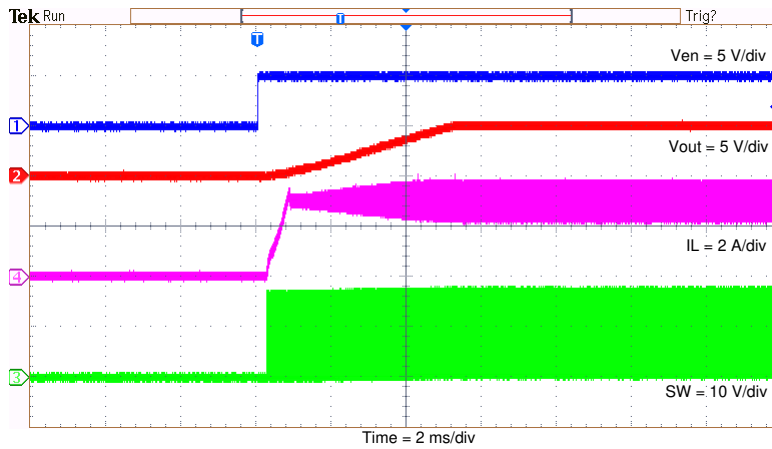

Figure 5-11. TPS56339EVM Startup Relative to Enable

### 5.9 Powering Down

Figure 5-12 and Figure 5-13 show the start-up waveforms for the TPS56339EVM. In Figure 5-12, the output voltage ramps down as soon as the input voltage falls below the UVLO stop threshold as set by the R1 and R2 resistor divider network. In Figure 5-13, the output is inhibited by using a 5-V logic signal between EN and GND. The input voltage for these plots is 19 V and the load current is 3 A.

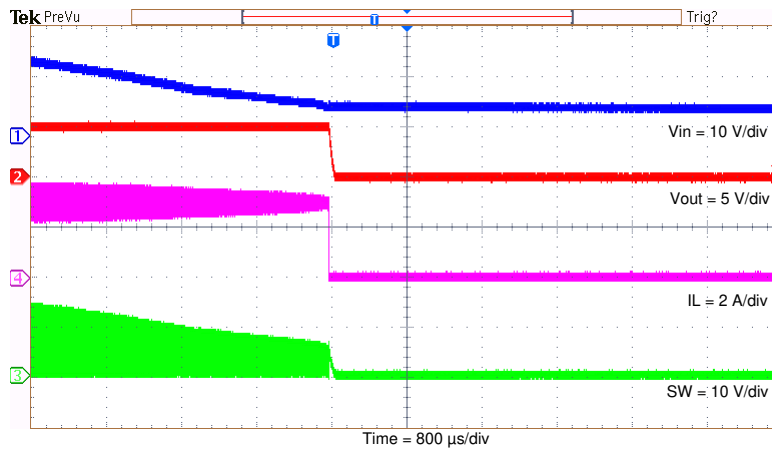

Figure 5-12. TPS56339EVM Shutdown Relative to  $V_{IN}$

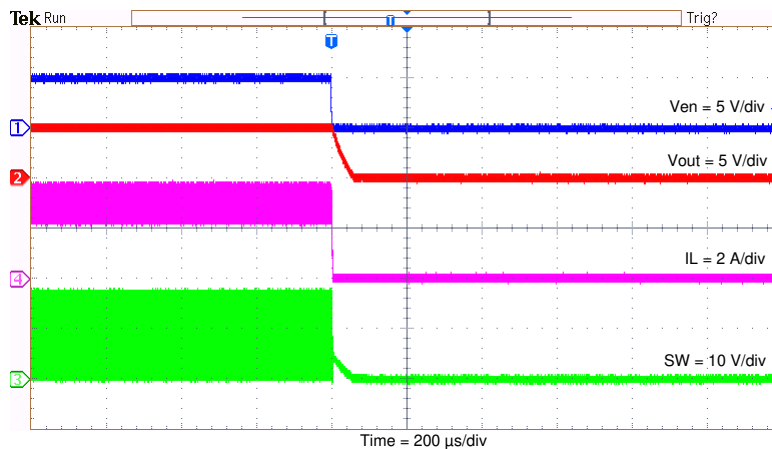

Figure 5-13. TPS56339EVM Shutdown Relative to EN

## 5.10 Output Short Protection and Recovery

Figure 5-14 and Figure 5-15 show the waveforms of output short protection and recovery.

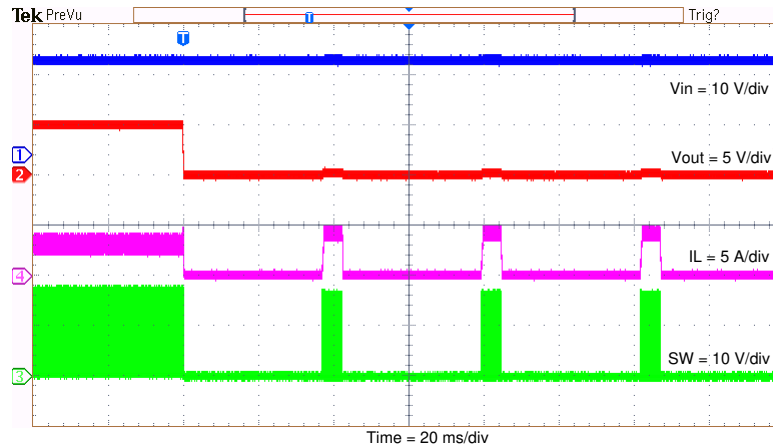

Figure 5-14. TPS56339EVM Short Protection

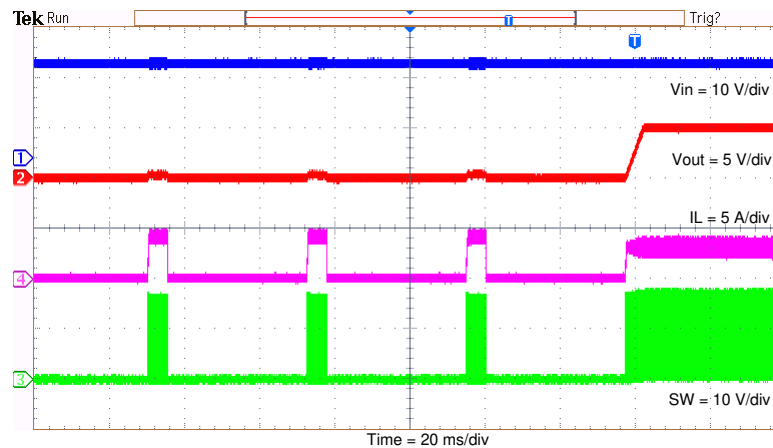

Figure 5-15. TPS56339EVM Short Recovery

## 5.11 Thermal Performance

Figure 5-16 shows the thermal performance of the TPS56339EVM under  $V_{IN} = 19\text{ V}$ ,  $V_{OUT} = 5\text{ V}$ ,  $I_{OUT} = 3\text{ A}$ .

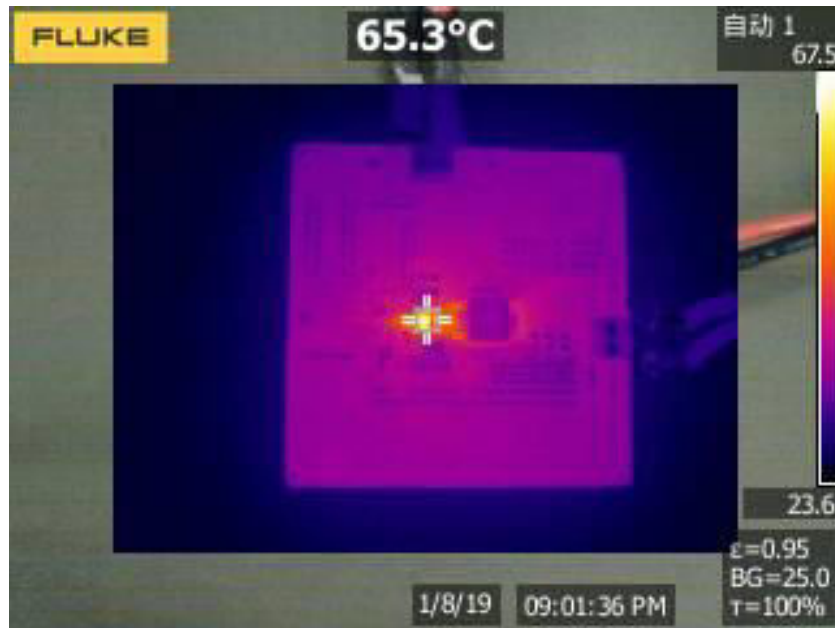

Figure 5-16. TPS56339EVM Thermal Performance

## 6 Board Layout

This section provides a description of the TPS56339EVM, board layout, and layer illustrations.

### 6.1 Layout

Figure 6-1 , Figure 6-2 and Figure 6-3 show the board layout for the TPS56339EVM. The topside layer of the EVM is laid out in a manner typical of a user application. The top and bottom layers are 2-oz. copper.

The top layer contains the main power traces for  $V_{IN}$ ,  $V_{OUT}$ , and SW. Also on the top layer are connections for the remaining pins of the TPS56339 and a large area filled with ground. To facilitate the placement of the main input bypass capacitor as close to the  $V_{IN}$  and GND pins as possible. The input decoupling capacitors (C2, and C3) and bootstrap capacitor (C4) are all located as close to the IC as possible. In addition, the voltage set-point resistor divider components are also kept close to the IC. For the TPS56339, an additional input bulk capacitor may be required, depending on the EVM connection to the input supply.

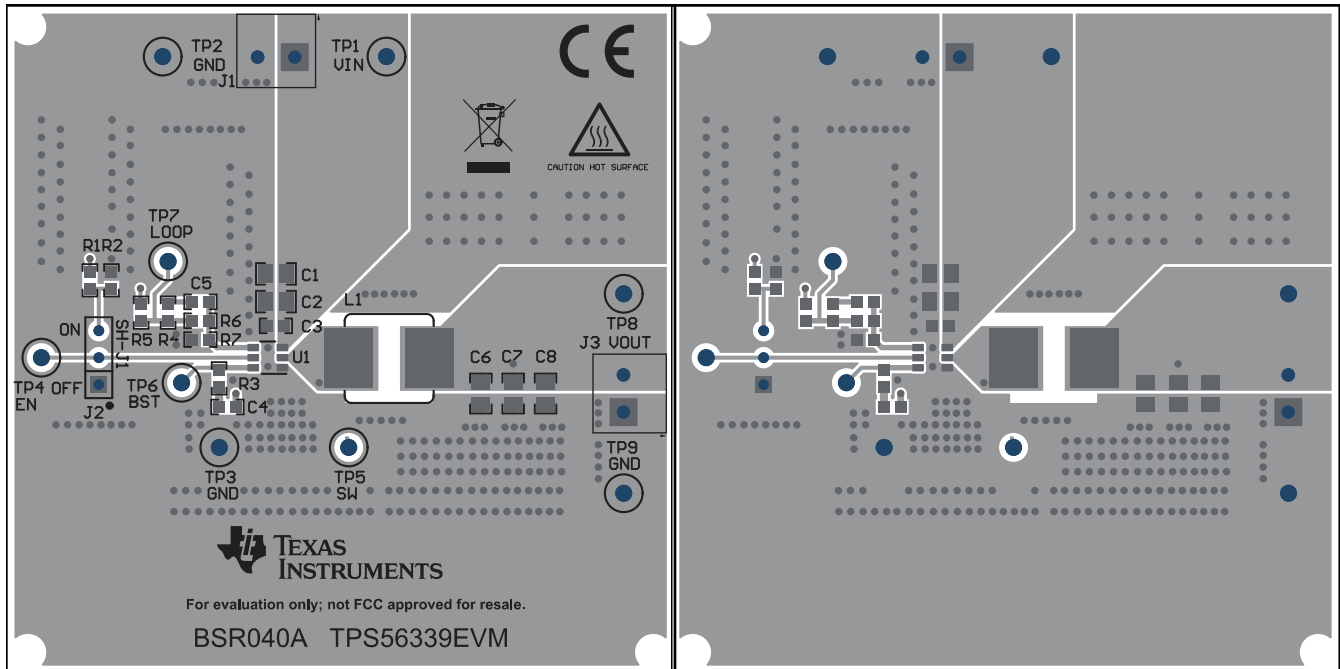
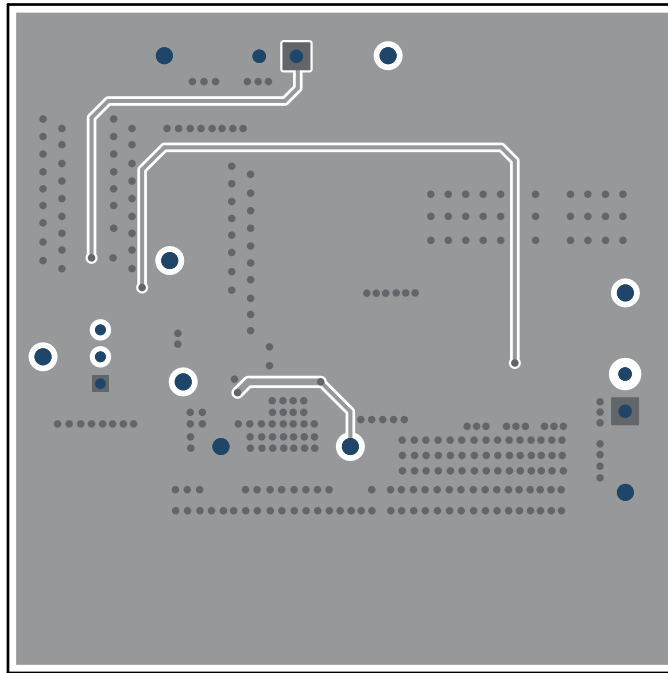

Figure 6-1. Top Assembly

Figure 6-2. Top Layer





**Figure 6-3. Bottom Layer**

## 7 Schematic and List of Materials

This section presents the TPS56339EVM schematic and list of materials.

### 7.1 Schematic

Figure 7-1 is the schematic for the TPS56339EVM.

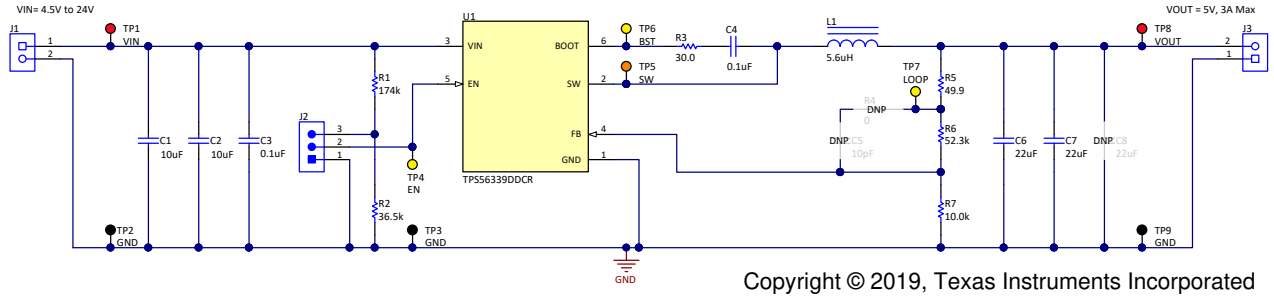

**Figure 7-1. TPS56339EVM Schematic**

## 7.2 List of Materials

Table 7-1 presents the list of materials for the TPS56339EVM.

**Table 7-1. TPS56339EVM List of Materials**

Designator	Qty	Value	Description	Package Reference	Part Number	Manufacturer	Alternate PartNumber	Alternate Manufacturer
C1, C2	2	10uF	CAP, CERM, 10 uF, 35 V, +/- 10%, X5R, 0805	0805	GRM21BR6YA106KE43L	Murata		
C3, C4	2	0.1uF	CAP, CERM, 0.1uF, 50V, +/-10%, X7R, 0603	0603	885012206095	Murata		
C6, C7	2	22uF	CAP, CERM, 22 uF, 16 V, +/- 20%, X5R, 0805	0805	GRM21BR61C226ME44	Murata		
J1, J3	2		Terminal Block, 3.5mm Pitch, 2x1, TH	7.0x8.2x6.5mm	ED555/2DS	On-Shore Technology		
J2	1		Header, 100mil, 3x1, Tin, TH	Header, 3 PIN, 100mil, Tin	PEC03SAAN	Sullins Connector Solutions		
L1	1	5.6uH	Inductor, Shielded, Powdered Iron, 5.6 uH, 7.4 A, 0.0268 ohm, SMD	322x158x322mil	SRP1038A-5R6M	Vishay-Dale	SRP1038A-5R6M	Bourns
R1	1	174k	RES, 174 k, 0.1%, 0.1 W, 0603	0603	RT0603BRD07174KL	Yageo America		
R2	1	36.5k	RES, 36.5 k, 0.1%, 0.1 W, 0603	0603	'RT0603BRD0736K5L	Yageo America		
R3	1	30.0	RES, 30.0, 1%, 0.1 W, 0603	0603	RC0603FR-0730RL	Panasonic		
R5	1	49.9	RES, 49.9, 0.5%, 0.1 W, 0603	0603	RT0603DRE0749R9L	Yageo America		
R6	1	52.3k	RES, 52.3 k, 0.1%, 0.1 W, 0603	0603	'RT0603BRD0752K3L	Susumu Co Ltd		
R7	1	10.0k	RES, 10.0 k, 0.1%, 0.1 W, 0603	0603	'RT0603BRD0710KL	Yageo America		
SH-JP1	1	1x2	Shunt, 100mil, Gold plated, Black	Shunt	969102-0000-DA	3M		
TP1, TP8	2		Test Point, Multipurpose, Red, TH	Red Multipurpose Testpoint	5010	Keystone		
TP2, TP3, TP9	3		Test Point, Multipurpose, Black, TH	Black Multipurpose Testpoint	5011	Keystone		
TP4, TP6, TP7	3		Test Point, Multipurpose, Yellow, TH	Yellow Multipurpose Testpoint	5014	Keystone		
TP5	1		Test Point, Multipurpose, Orange, TH	Orange Multipurpose Testpoint	5013	Keystone		
U1	1		4.5V to 24 V Input, 3-A Synchronous Step-Down Voltage Regulator, DDC0006A	DDC0006A	TPS56339DDCR	Texas Instruments	TPS56339DDCT	Texas Instruments

## 8 Revision History

NOTE: Page numbers for previous revisions may differ from page numbers in the current version.

<b>Changes from Revision B (May 2019) to Revision C (July 2021)</b>		<b>Page</b>
• Updated the numbering format for tables, figures, and cross-references throughout the document. ....		3
• Updated user's guide title.....		3
<b>Changes from Revision A (November 2018 May 2019) to Revision B ( )</b>		<b>Page</b>
• Added <a href="#">Figure 4-1</a> TPS56339EVM front and back images.....		7

## IMPORTANT NOTICE AND DISCLAIMER

TI PROVIDES TECHNICAL AND RELIABILITY DATA (INCLUDING DATA SHEETS), DESIGN RESOURCES (INCLUDING REFERENCE DESIGNS), APPLICATION OR OTHER DESIGN ADVICE, WEB TOOLS, SAFETY INFORMATION, AND OTHER RESOURCES "AS IS" AND WITH ALL FAULTS, AND DISCLAIMS ALL WARRANTIES, EXPRESS AND IMPLIED, INCLUDING WITHOUT LIMITATION ANY IMPLIED WARRANTIES OF MERCHANTABILITY, FITNESS FOR A PARTICULAR PURPOSE OR NON-INFRINGEMENT OF THIRD PARTY INTELLECTUAL PROPERTY RIGHTS.

These resources are intended for skilled developers designing with TI products. You are solely responsible for (1) selecting the appropriate TI products for your application, (2) designing, validating and testing your application, and (3) ensuring your application meets applicable standards, and any other safety, security, regulatory or other requirements.

These resources are subject to change without notice. TI grants you permission to use these resources only for development of an application that uses the TI products described in the resource. Other reproduction and display of these resources is prohibited. No license is granted to any other TI intellectual property right or to any third party intellectual property right. TI disclaims responsibility for, and you will fully indemnify TI and its representatives against, any claims, damages, costs, losses, and liabilities arising out of your use of these resources.

TI's products are provided subject to [TI's Terms of Sale](#) or other applicable terms available either on [ti.com](http://ti.com) or provided in conjunction with such TI products. TI's provision of these resources does not expand or otherwise alter TI's applicable warranties or warranty disclaimers for TI products.

TI objects to and rejects any additional or different terms you may have proposed.

Mailing Address: Texas Instruments, Post Office Box 655303, Dallas, Texas 75265  
Copyright © 2022, Texas Instruments Incorporated