

TPS23882B1EVM: PoE, PSE, TPS23882B1 Evaluation Module



ABSTRACT

This user's guide describes the evaluation modules (EVM) for the TPS23882B1 (TPS23882B1EVM-008 and BOOST-PSEMTHR8-097). The EVM contains evaluation and reference circuitry for the TPS23882B1. The TPS23882B1 is a Power-over-Ethernet (PoE) device for power sourcing equipment (PSE).

Table of Contents

1 Description	2
1.1 Features	2
1.2 Applications	2
2 Quick Start	3
2.1 Input Power	3
2.2 PoE Port Interfaces	3
2.3 I ² C Interfaces	3
2.4 Basic Test Setup Using Autonomous Mode	4
2.5 Basic Test Setup Using USB2ANY for I ² C Interface (Auto Mode or Semi-Auto Mode Operation with I ² C Monitoring)	5
2.6 Advanced Test Setup Using MSP-EX430FR5969 LaunchPad™	6
3 General Use Features	7
3.1 EVM Input/Output Connectors and Switches	7
3.2 EVM LEDs	7
3.3 EVM Test Points	8
3.4 EVM Test Jumpers	9
4 TPS23882B1 GUI Setup	10
4.1 TPS23882B1 GUI Installation	10
4.2 TPS23882B1 GUI Operation	10
4.3 MSP-EXP430FR5969 Details	14
4.4 MSP430 Reference Code	16
5 EVM Schematic, Layout Guidelines, PCB Assembly and Layer Plots	17
5.1 Schematic	18
5.2 Layout Guidelines	21
5.3 PCB Drawings	21
6 Bill of Materials	26

Trademarks

LaunchPad™ and Code Composer Studio™ are trademarks of Texas Instruments.
All trademarks are the property of their respective owners.

1 Description

The TPS23882B1 features the TPS23882B1: an 8-channel, IEEE802.3bt compliant PoE PSE controller. The EVM consists of a motherboard (BOOST-PSEMTHR8-097) and a daughterboard (TPS23882B1EVM-008) containing one TPS23882B1 device. The TPS23882B1 EVM provides a multi-port base platform interface for TPS23882B1EVM-008, [MSP-EXP430FR5969](#) (LaunchPad™), and [USB2ANY](#) (USB Interface Adapter).

1.1 Features

The EVM supports the following features:

- Eight IEEE802.3bt 2-pair ports with 1000BASE-T (gigabit Ethernet data pass-through)
- Single DC power supply input
- Onboard 3.3-V regulator
- Onboard I²C interface to the TPS23882B1 device from either [USB2ANY](#) or [MSP-EXP430FR5969](#).
- Port ON status LEDs
- Reset button for easy reconfiguration
- User test points

1.2 Applications

The EVM is used in the following applications:

- Enterprise and SoHO switches and routers
- Connected ceiling LED switches
- PoE pass-through power modules
- Network video recorders (NVRs)
- Wireless backhaul and small-cell networking

2 Quick Start

2.1 Input Power

2.1.1 Input Power (Labeled VPWR)

The DC input voltage is provided through J1 on the motherboard (screw jack). A DC power supply or wall adapter with sufficient current capacity can power the EVM.

CAUTION

Reverse voltage protection is not provided; ensure that the correct polarity is applied to J1.

This DC input is labeled *VPWR* in the schematics, is used for port VBUS and for the TPS23882B1 devices. The *VPWR* connections to the PoE ports are not fused. Each two-pair port is capable of furnishing at least 30 W.

The minimum PSE port voltage is 44 VDC for type 1 and 50 V for type 2 and type 3. During evaluation, choose the appropriate DC power supply for different environments.

2.1.2 Local 3.3 V (Labeled 3.3 V)

Local 3.3 V for local devices (labeled as 3.3 V) is provided by the onboard LM5019 buck converter. The LM5019 provides a basic power-on sequence and provides a well-controlled and consistent start-up. In addition to 54 V, the TPS23882B1 requires 3.3 V for the digital circuitry and this is routed up to TPS23882B1EVM-008 over the connector interface. The current consumption is 6-mA typical and 12-mA maximum.

2.1.3 External 3.3 V (Labeled 3.3 V_USB)

The BOOST-PSEMTHR8-097 provides galvanic isolation between the PoE power side and host side using digital isolators (ISO7241CD). The host side power is provided either from J2 of the mother board (from [USB2ANY](#)) or J5 of the motherboard (from [MSP-EXP430FR5969](#)).

CAUTION

Do not use USB2ANY and LaunchPad simultaneously.

Table 2-1. TPS23882B1 Voltage Rail Current Requirements

Voltage Rail	Typical (mA)	Maximum (mA)
3.3 V_USB	2.5	3
3.3 V	6	12
VPWR (Miscellaneous)	35	57
VPWR (8 × 2 Pair Ports)	4800	5455
VPWR Total (8 × 2 Pair Ports)	4835	5512

2.2 PoE Port Interfaces

The TPS23882B1 device must be configured through the host to become operational if the device is not configured to autonomous mode (described in section 2.4). This EVM provides 2 ways to control the TPS23882B1: TPS238x EVM GUI (with [USB2ANY](#)) and Basic Reference Code (with [MSP-EXP430FR5969](#) LaunchPad).

2.2.1 IEEE802.3bt 2-Pair Ports

Eight 2-pair ports are provided at J19, J20, J8, J7, J32, J33, J21, and J9 of the motherboard for 2-pair ports 1, 2, 3, 4, 5, 6, 7, and 8 respectively. The power furnished is according to alternative A with MDI-X polarity.

2.3 I²C Interfaces

Two I²C interfaces to the TPS23882B1 are provided on the EVM.

2.3.1 USB2ANY

J2 of the motherboard provides an interface with the [USB2ANY](#) adapter when using a PC and GUI.

2.3.2 MSP-EXP430FR5969

J3, J4, and J5 of the motherboard provide an interface with the [MSP-EXP430FR5969](#) when using a PC to develop custom system software.

2.4 Basic Test Setup Using Autonomous Mode

The TPS23882B1 supports autonomous mode which means it can operate without any host control. During power up the resistance on the AUTO pin is measured and the device is pre-configured according to the jumper configuration on J5 of the daughterboard. All ports are configured with the same power level. Due to the hardware configuration on the motherboard, all 2-pair ports are interoperable with PDs. Only 2P-15W and 2P-30W are valid selections on the TPS23882B1EVM-008 as the other resistors are not populated.

To test with autonomous mode, install a jumper on the pins of J5 corresponding to the desired power level and power on the board without the [USB2ANY](#) or [MSP-EXP430FR5969](#) connected. [Figure 2-1](#) illustrates the basic setup using autonomous mode.

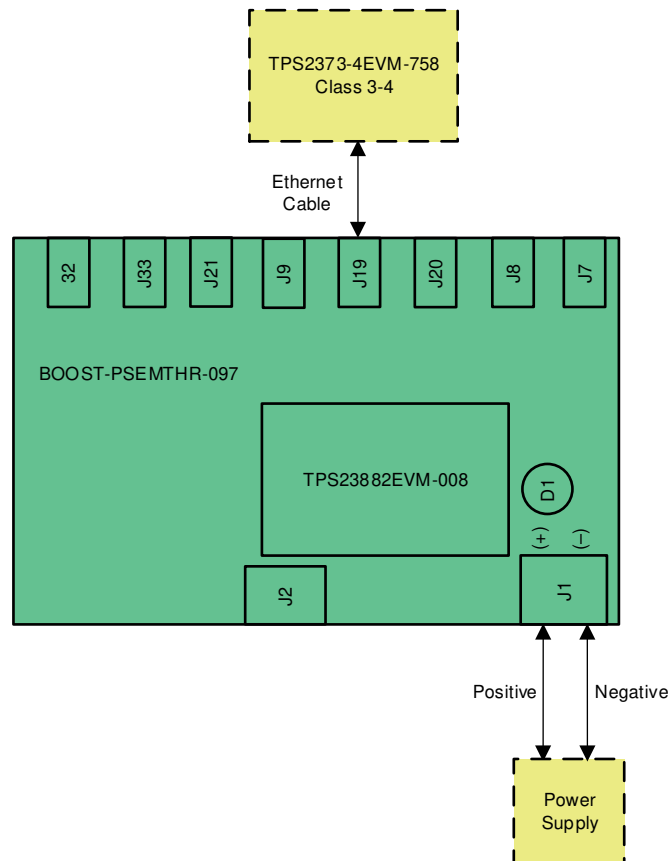

Figure 2-1. Basic Setup Using Autonomous Mode

If the EVM is powered with a jumper on J5 of the daughterboard, the device will automatically enter autonomous mode at the selected power level. If the selected power level changes, the EVM must be power cycled for the change to take effect.

Table 2-2. AUTO Pin Programming

AUTO Pin	Autonomous Mode Configuration	Resulting Register Configurations		
		Register 0x12h	Register 0x14h	Register 0x29h
Open/Floating	Disabled	0x00h	0x00h	0x00h
124 k Ω	2-pair 15 W	0xFFh	0xFFh	0x00h
62 k Ω	2-pair 30 W	0xFFh	0xFFh	0x33h

2.5 Basic Test Setup Using USB2ANY for I²C Interface (Auto Mode or Semi-Auto Mode Operation with I²C Monitoring)

An I²C interface is provided through J2 of the motherboard to the TPS23882B1 device on the TPS23882B1EVM-008. The USB2ANY adapter (not included) can be used with any TI GUI which uses USB2ANY to read and write over an I²C bus. Figure 2-2 illustrates the basic setup using USB2ANY.

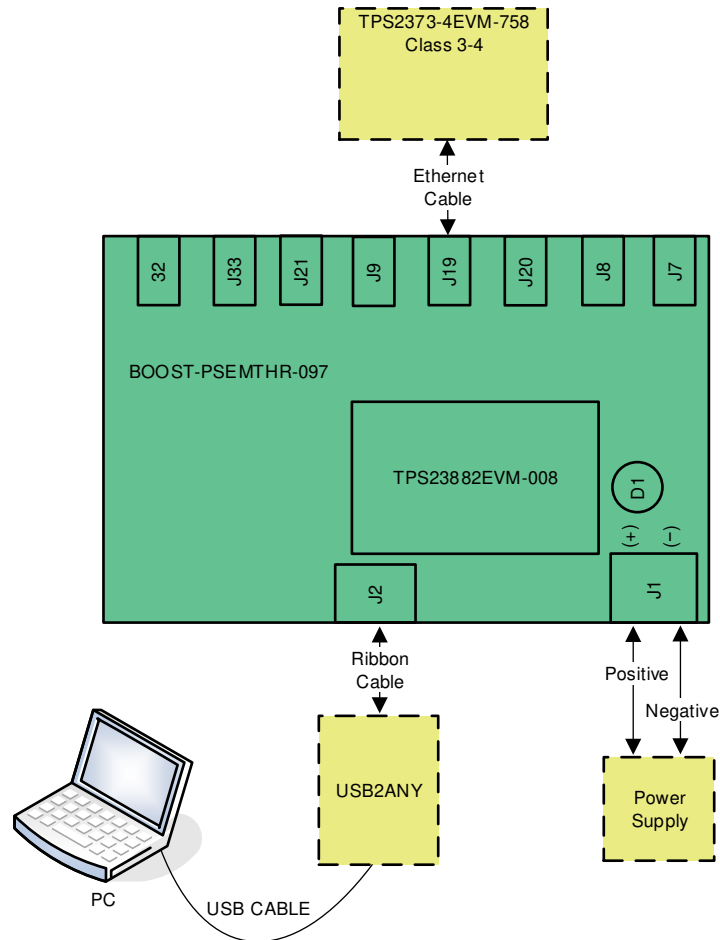

Figure 2-2. Basic Setup Using USB2ANY

CAUTION

If wanting to run TPS23882B1 in semi-auto mode, remove the jumper installed on J5 of the TPS23882B1 daughterboard before powering on the board.

2.6 Advanced Test Setup Using MSP-EX430FR5969 LaunchPad™

The LaunchPad (not included) running a custom software program can communicate with the TPS23882B1 devices on the TPS23882B1EVM-008. [Figure 2-3](#) shows the advanced setup using LaunchPad.

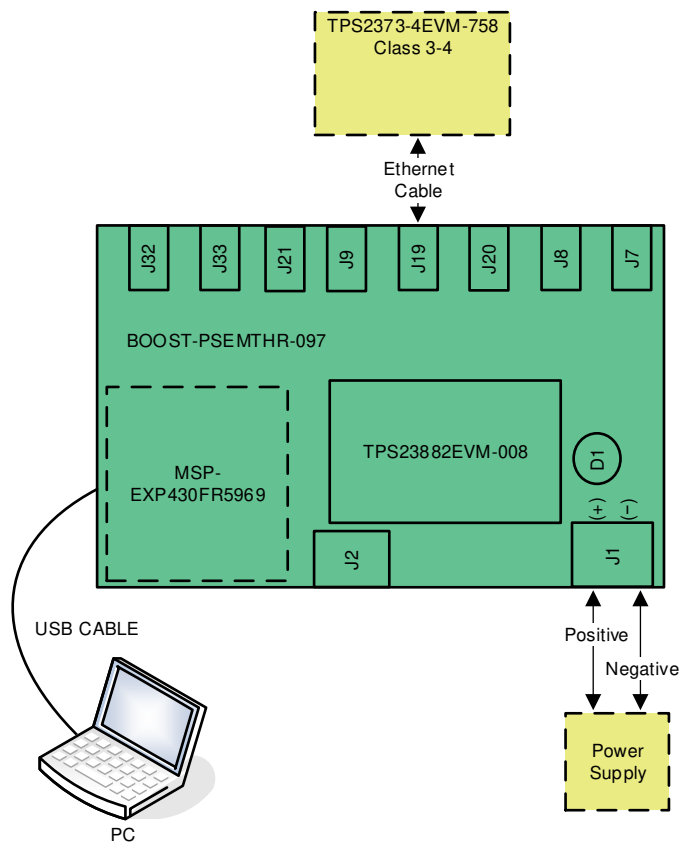

Figure 2-3. Advanced Setup Using LaunchPad™

CAUTION

If wanting to run TPS23882B1 in semi-auto mode, remove the jumper installed on J5 of the TPS23882B1 daughterboard before powering on the board.

CAUTION

Do not press the RESET button (S1) on the motherboard while communicating over I2C. Pressing this button will set all ports to off mode and the reference code will not be able to recover.

3 General Use Features

3.1 EVM Input/Output Connectors and Switches

Table 3-1 lists the EVM input and output connectors on the mother board.

Table 3-1. EVM Input/Output Connectors

Connector or Switch	Label	Description
S1	RESET	Button to send a hardware reset signal to the TPS23882B1
J1	J1	DC power supply screw jack. (44–57 VDC). Use a 48 VDC (nominal) for type 1 and 54 VDC (nominal) for type 2, 3, and 4 PSE operation.
J2	J2	Ribbon cable connection to USB2ANY adapter
J3	J3	LaunchPad control (mates with LaunchPad J1)
J4	J4	LaunchPad I ² C (mates with LaunchPad J2)
J5	J5	LaunchPad power (onboard, mates with LaunchPad J6)
J6	J6	TPS23882B1EVM-008 control (mates with TPS23882B1EVM-008 J3)
J17	J17	TPS23882B1EVM-008 Channel 5–8 (mates with TPS23882B1EVM-008 J2)
J18	J18	TPS23882B1EVM-008 Channel 1–4 (mates with TPS23882B1EVM-008 J1)
J22	J22	Two-pair port 1 data only
J19	2 Pair Port 1	Two-pair port 1 power and data
J23	J23	Two-pair port 2 data only
J20	2 Pair Port 2	Two-pair port 2 power and data
J11	J11	Two-pair port 3 data only
J8	2 Pair Port 3	Two-pair port 3 power and data
J10	J10	Two-pair port 4 data only
J7	2 Pair Port 4	Two-pair port 4 power and data
J31	J31	Two-pair port 5 data only
J32	2 Pair Port 5	Two-pair port 5 power and data
J30	J30	Two-pair port 6 data only
J33	2 Pair Port 6	Two-pair port 6 power and data
J24	J24	Two-pair port 7 data only
J21	2 Pair Port 7	Two-pair port 7 power and data
J12	J12	Two-pair port 8 data only
J9	2 Pair Port 8	Two-pair port 8 power and data
J29	J29	Chassis ground tie point

3.2 EVM LEDs

Table 3-2 lists the motherboard LEDs and their descriptions.

Table 3-2. EVM LEDs

LED	Color	Label	Description
D1	GREEN	48 V	48-V ON indicator
D13	BLUE	D13	Two-pair port 1 power is ON. For J19 supplier #1 (see the bill of materials (BOM)), J19 internal port LED is active. For supplier #2, D13 is active.
D15	BLUE	D15	Two-pair port 2 power is ON. For J20 supplier #1 (see the BOM), J20 internal port LED is active. For supplier #2, D15 is active.
D14	BLUE	D14	Two-pair port 3 power is ON. For J8 supplier #1 (see the BOM), J8 internal port LED is active. For supplier #2, D14 is active.
D12	BLUE	D12	Two-pair port 4 power is ON. For J7 supplier #1 (see the BOM), J7 internal port LED is active. For supplier #2, D12 is active.
D19	BLUE	D19	Two-pair port 5 power is ON. For J32 supplier #1 (see the BOM), J32 internal port LED is active. For supplier #2, D19 is active.

Table 3-2. EVM LEDs (continued)

LED	Color	Label	Description
D18	BLUE	D18	Two-pair port 6 power is ON. For J33 supplier #1 (see the BOM), J33 internal port LED is active. For supplier #2, D18 is active.
D17	BLUE	D17	Two-pair port 7 power is ON. For J21 supplier #1 (see the BOM), J21 internal port LED is active. For supplier #2, D17 is active.
D16	BLUE	D16	Two-pair port 8 power is ON. For J9 supplier #1 (see the BOM), J9 internal port LED is active. For supplier #2, D16 is active.
D3	GREEN	D3	Debug LED

3.3 EVM Test Points

[Table 3-3](#) lists and describes the EVM test points.

Table 3-3. EVM Test Points

TP	Color	Label	Description
Motherboard: BOOST-PSEMTHR8-097			
TP1	RED	VPWR	Used for VPWR
TP2	RED	3.3 V	Used for TPS23882B1 VDD
TP3	SMT	GND	VPWR ground
TP4	WHT	SDA	I ² C Data from LaunchPad and USB-TO-GPIO
TP5	WHT	SCL	I ² C Clock from LaunchPad and USB-TO-GPIO
TP6	WHT	PSE_SDAO	I ² C data out from TPS23882B1
TP7	WHT	PSE_SCL	I ² C clock to TPS23882B1
TP8	WHT	PSE_SDAI	I ² C data in to TPS23882B1
TP9	BLK	GND1	Ground from LaunchPad and USB2ANY
TP10	SMT	GND	VPWR ground test point
TP11	SMT	TP11	VPWR ground test point
TP12	SMT	GND	VPWR ground test point
TP13	SMT	GND	VPWR ground test point
Daughterboard: TPS23882B1EVM-008			
TP2	RED	2P4D	Two-pair port 4 DRAIN
TP3	WHT	2P4G	Two-pair port 4 GATE
TP4	WHT	2P5G	Two-pair port 5 GATE
TP5	RED	2P5D	Two-pair port 5 DRAIN
TP7	WHT	2P6G	Two-pair port 6 GATE
TP6	RED	2P6D	Two-pair port 6 DRAIN
TP1	BLK	GND	VPWR ground
TP8	SMT	GND	VPWR ground

3.4 EVM Test Jumpers

The EVM is equipped with shunts on the jumper positions identified in [Table 3-4](#), in the *Default Pin Position* column. Shunts can be moved and removed, as required, during use.

Table 3-4. EVM Jumpers

Jumper	Default Pin Position	Label	Description
Motherboard: BOOST-PSEMTHR8-097			
J27	1-2	P1	Two-pair port 1 LED bias
J28	1-2	P2	Two-pair port 2 LED bias
J16	1-2	P3	Two-pair port 3 LED bias
J15	1-2	P4	Two-pair port 4 LED bias
J26	1-2	P5	Two-pair port 5 LED bias
J25	1-2	P6	Two-pair port 6 LED bias
J14	1-2	P7	Two-pair port 7 LED bias
J13	1-2	P8	Two-pair port 8 LED bias
Daughterboard: TPS23882B1EVM-008			
J4	1-2;3-4;5-6;7-8	A1;A2;A3;A4	I2C A1-A4 address lines
J5	3-4	2P-30 W	AUTO pin selection (autonomous mode is enabled if connecting auto pin to ground with selected resistance, 2-pair 30-W operation is selected by default)

4 TPS23882B1 GUI Setup

4.1 TPS23882B1 GUI Installation

TI's TPS23882B1 GUI is used with the TPS23882B1 to control the port and provide real-time feedback on port telemetry. Download the TPS23882B1 GUI from the [TPS23882B1 product folder page](#) in the *Tools and software* section.

Follow the onscreen instructions to complete the installation. The TPS23882B1 GUI uses the USB2ANY as an interface between the PC USB port and the BOOST-PSEMTHR8-097 J2 connector (I2C interface). Before starting the TPS23882B1 GUI, make sure the USB2ANY is properly connected to TPS23882B1 and the EVM is supplied with a 44- to 57-V power supply as shown in [Figure 2-2](#).

4.2 TPS23882B1 GUI Operation

Start the TPS23882B1 GUI by double clicking the GUI icon. A window similar to [Figure 4-1](#) will come up.

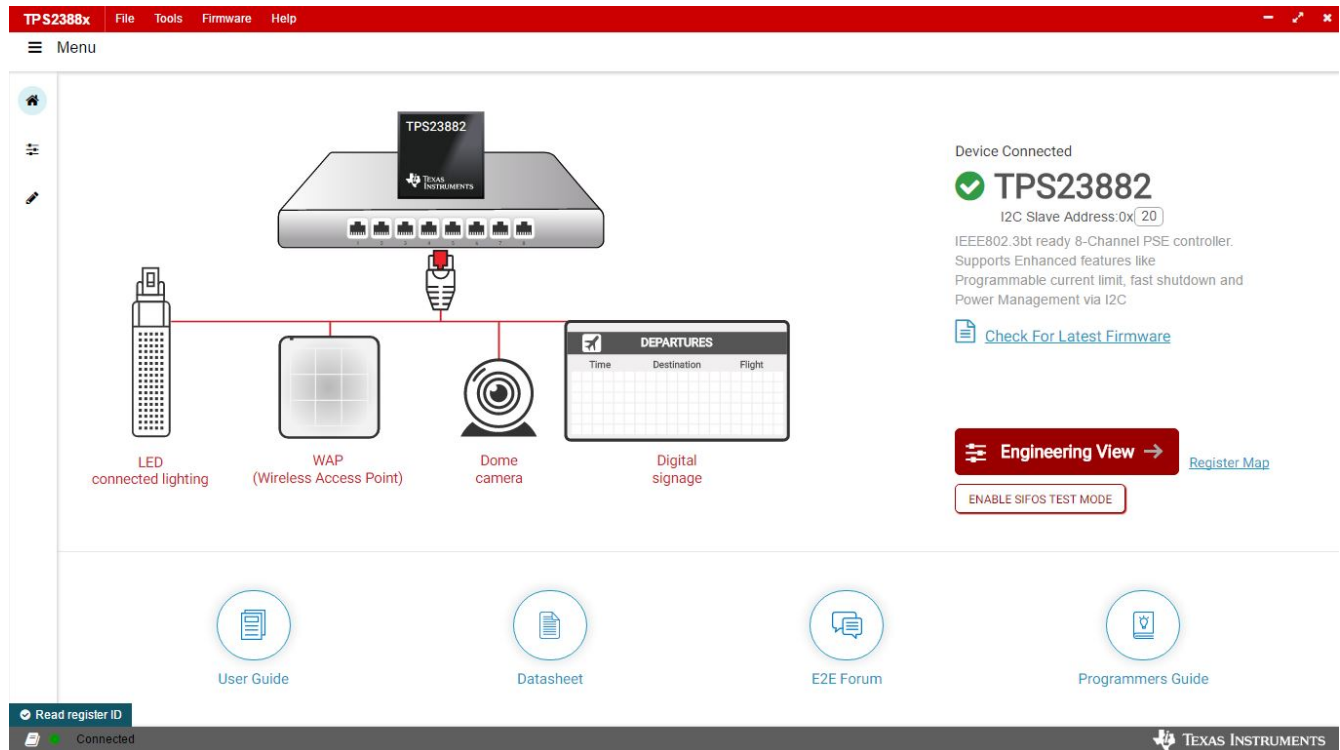

Figure 4-1. TPS23882B1 GUI Startup Window

The default device address in the GUI is set to 0x20 which matches the default configuration of the EVM (J4 on the daughter card is installed with jumpers). The GUI sets the TPS23882B1 in configuration B mode (see the *GENERAL MASK Register* section of the data sheet for details). The address can be programmed through the A1 to A4 pins and the I2C address setting in the GUI needs to match the hardware configuration. See the *Pin Status Register* section of the data sheet for details. The startup page contains links to the EVM user's guide, TPS23882B1 data sheet, E2E forum and MSP430 reference code. Four popular PD end-equipment images are connected to the PSE switch. Links to the recommended PD device for each end equipment are also provided.

Once the TPS23882B1 device is connected, click Firmware to select firmware to be loaded to TPS23882B1.

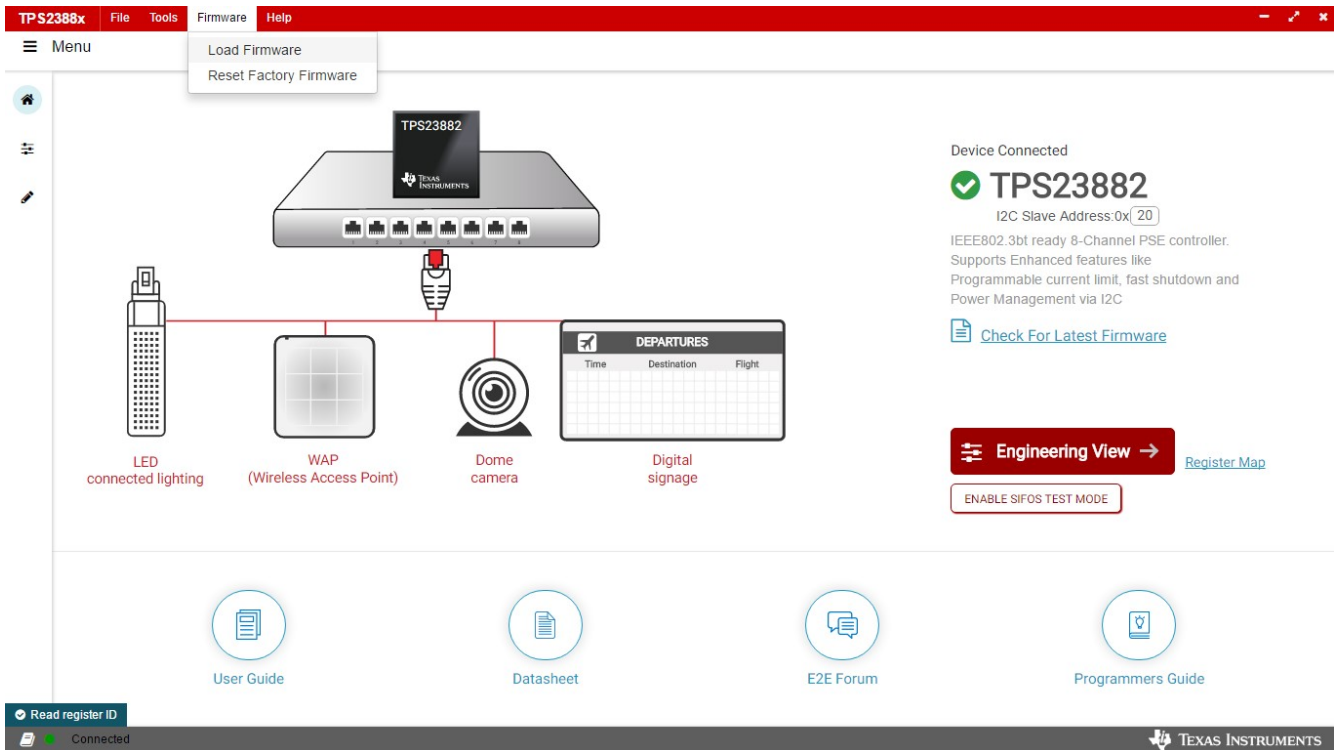

Figure 4-2. TPS23882B1 GUI Load Firmware 1

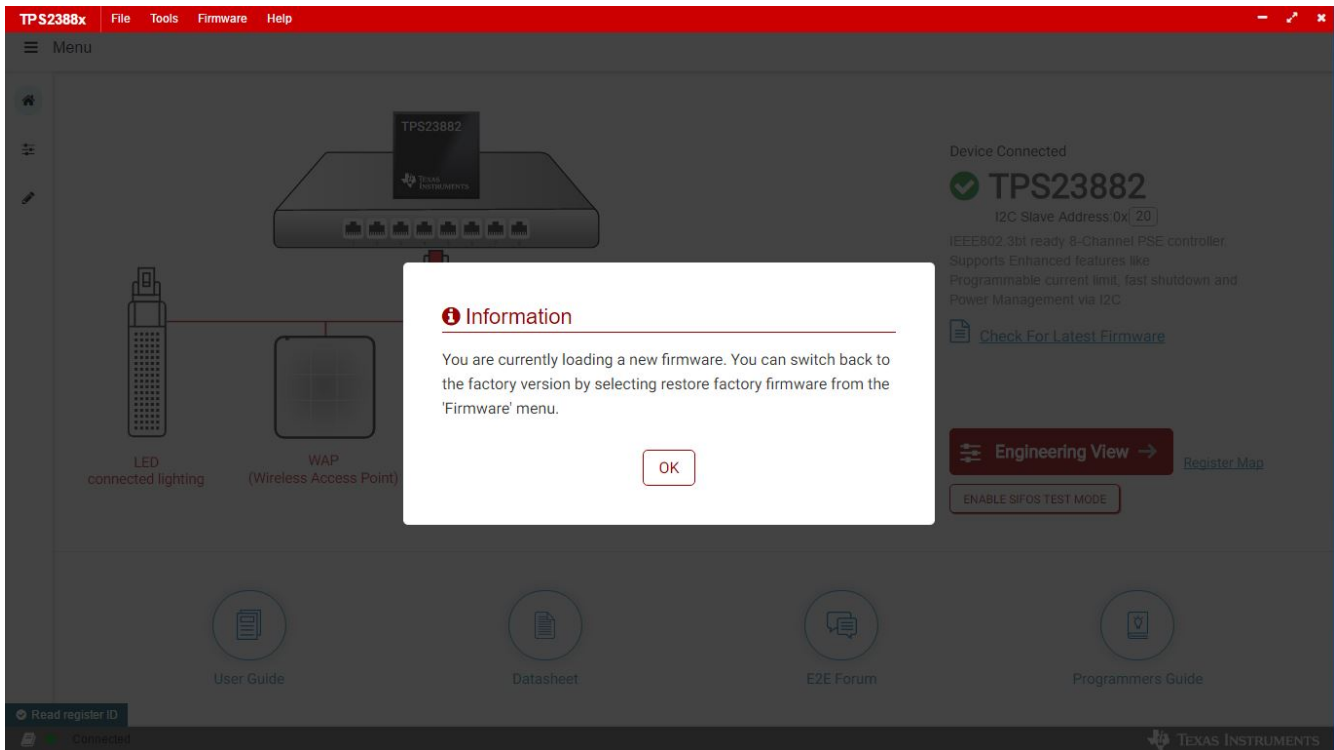

Figure 4-3. TPS23882B1 GUI Load Firmware 2

Once firmware is successfully loaded and *Device Connected* displays and port configuration type is selected, click *Engineering View*.

On the page displayed in [Figure 4-4](#), each port can be configured separately by clicking each RJ45 connector. By default, the TPS23882B1 is configured in OFF Mode. Each port can be configured by clicking the RJ45 icon.

Clicking the **SET ALL PORTS TO STANDARD** button sets all port to standard configurations (configuring ports in Semi-Auto mode, enabling OSS, power policing, and DC disconnect). Clicking the **SET ALL PORTS TO AUTO MODE** button enables *Auto Mode* for all ports.

The status of each port is shown on the configuration and telemetry page. The configuration of the ports can also be edited on this page by clicking the RJ45 connector.

If the port is configured in *Auto Mode*, the port will turn on automatically by the PSE device after connecting a valid PD. If not configured in *Auto Mode*, a port enable command is required. The port can be turned on only when the PD has valid detection and classification results.

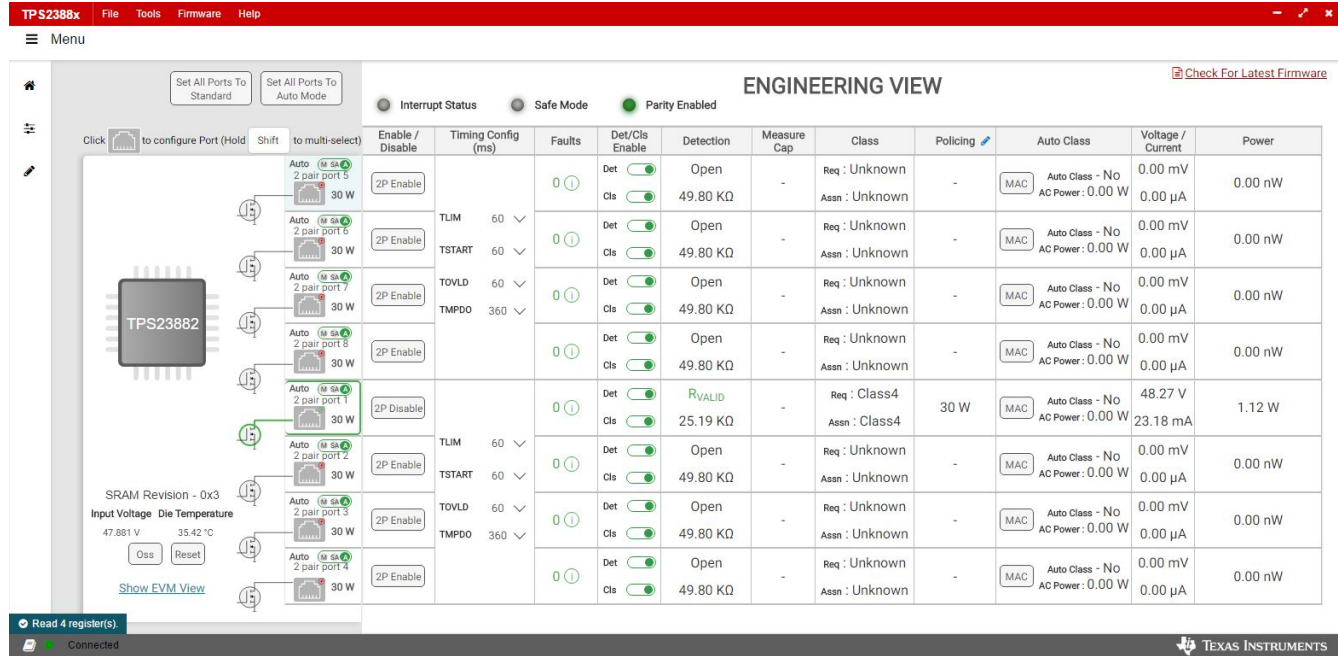

Figure 4-4. Device Configuration and Port Telemetry Page

The GUI also provides access to every register of the device in the register map.

TPS2388x File Tools Firmware Help

Menu

Register Map Auto Read: Off Read Register Read All Registers Write Register Immediate

Register Name	Address	Value	Bits																
			15	14	13	12	11	10	9	8	7	6	5	4	3	2	1	0	
INTERRUPTS																			
INTERRUPT	0x00	0x081B	0	0	0	0	1	0	0	0	0	0	0	0	1	1	0	1	1
INTERRUPT MASK	0x01	0xE4E4	1	1	1	0	0	1	0	0	1	1	1	0	0	1	0	0	
EVENT																			
POWER EVENT RO	0x02	0x0011	0	0	0	0	0	0	0	0	0	0	0	0	1	0	0	0	1
POWER EVENT CoR	0x03	0x0011	0	0	0	0	0	0	0	0	0	0	0	0	1	0	0	0	1
DETECTION EVENT RO	0x04	0x0F1F	0	0	0	0	1	1	1	1	0	0	0	1	1	1	1	1	1
DETECTION EVENT CoR	0x05	0x0F1F	0	0	0	0	1	1	1	1	0	0	0	1	1	1	1	1	1
FAULT EVENT RO	0x06	0x0	0	0	0	0	0	0	0	0	0	0	0	0	0	0	0	0	0
FAULT EVENT CoR	0x07	0x0	0	0	0	0	0	0	0	0	0	0	0	0	0	0	0	0	0
START/ILIM EVENT RO	0x08	0x0	0	0	0	0	0	0	0	0	0	0	0	0	0	0	0	0	0
START/ILIM EVENT CoR	0x09	0x0	0	0	0	0	0	0	0	0	0	0	0	0	0	0	0	0	0
SUPPLY EVENT RO	0x0A	0x0000	0	0	0	0	0	0	0	0	0	0	0	0	0	0	0	0	0
SUPPLY EVENT CoR	0x0B	0x0000	0	0	0	0	0	0	0	0	0	0	0	0	0	0	0	0	0
STATUS																			
STATUS 5.1	0x0C	0x0644	0	0	0	0	0	1	1	0	0	1	0	0	0	1	0	0	0
STATUS 6.2	0x0D	0x0606	0	0	0	0	0	1	1	0	0	0	0	0	0	1	1	0	0

FIELD VIEW

INTERRUPT

INTERRUPTS / INTERRUPT / SUPF [8:5]

● SUPF [8:5]

INTERRUPTS / INTERRUPT / STRTF [8:5]

● STRTF [8:5]

INTERRUPTS / INTERRUPT / IFAULT [8:5]

● IFAULT [8:5]

INTERRUPTS / INTERRUPT / CLASC [8:5]

● CLASC [8:5]

INTERRUPTS / INTERRUPT / DETC [8:5]

Read register ID Connected TEXAS INSTRUMENTS

Figure 4-5. Register Map

4.3 MSP-EXP430FR5969 Details

The TPS23882B1 accepts the MSP-EXP430FR5969 evaluation module when the application requires management of the TPS23882B1 devices with an external controller.

1. Install MSP-EXP430FR5969 onto BOOST-PSEMTHR8-097 and ensure that the USB2ANY ribbon cable is NOT installed into J2.
2. Connect the PC to the LaunchPad as shown in [Figure 2-3](#).
3. The source code was developed for the MSP430 LaunchPad Development Kit (MSP-EXP430GFR5969) using the Code Composer Studio™ (CCS) version 7.2.0 development environment. The target MSP430 can be programmed within this environment.
4. Once CCS is installed, use the basic set of instructions listed in [Section 4.3.1](#) to import, build, and run the project. CCS version 7.2.0 is used in the following examples. Note that a terminal program such as HyperTerminal or Teraterm is required to view the output from the EVM when it is running.

4.3.1 Basic CCS and Terminal Setup

Use the following steps for basic CCS and terminal setup:

1. Launch the CCS program on the PC: *Start* → *Texas Instruments* → *Code Composer Studio 7.2.0* → *Code Composer Studio 7.2.0*.
2. OK the workspace location and CCS starts.
3. Import the project: *Project* → *Import CCS Projects* (make sure you are in CCS Edit mode).
4. Navigate to the project location, then click the *Finish* button.
5. Build the project by clicking the hammer symbol. Semi-Auto or Auto mode can be switched selected using the drop-down arrow to the right of the hammer symbol.
6. Launch the debug session from CCS to activate the current project: *Run, Debug* (or F11).
7. Run the active project: *Run, Resume* (or play button, F8).
8. Determine the PC COM port connected to the LaunchPad by going into the *Device Manager Ports* (COM and LPT) section. Launch the terminal program.
9. Once the terminal program is properly connected to the LaunchPad running the PoE firmware, then text similar to the following image appears.

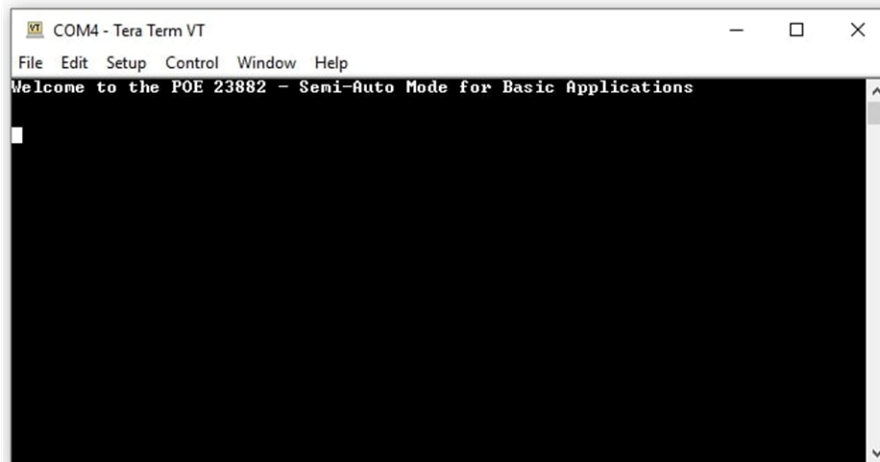

Figure 4-6. Semi-Auto UART Transmission Startup

10. The TPS23882B1 is now waiting for a PD load to be installed. As ports are installed, the system automatically detects, classifies, and powers up the port as shown in [Figure 4-7](#). Port status is updated on the screen approximately every 10 seconds.

```

COM4 - Tera Term VT
File Edit Setup Control Window Help
Welcome to the POE 23882 - Semi-Auto Mode for Basic Applications

Input Voltage: 54893 mV
Device Temperature: 41 degrees C
Firmware Revision: 03

Channel 01: OFF
  Detection Status: OPEN CIRCUIT
  Classification Status: Unknown
Channel 02: OFF
  Detection Status: OPEN CIRCUIT
  Classification Status: Unknown
Channel 03: OFF
  Detection Status: OPEN CIRCUIT
  Classification Status: Unknown
Channel 04: OFF
  Detection Status: OPEN CIRCUIT
  Classification Status: Unknown
Channel 05: ON
  Voltage: 54900 mV      Current: 25 mA
  Detection Status: RESISTANCE VALID  Detection Resistance: 24804 Ohm
  Classification Status: Class 4
Channel 06: ON
  Voltage: 54743 mV      Current: 31 mA
  Detection Status: RESISTANCE VALID  Detection Resistance: 24804 Ohm
  Classification Status: Class 8, 4 Pair Single Signature
Channel 07: OFF
  Detection Status: OPEN CIRCUIT
  Classification Status: Unknown
Channel 08: OFF
  Detection Status: OPEN CIRCUIT
  Classification Status: Unknown

---- Event Registers ---- Dev : 00-----
0x00  0x0F  0x00  0x00  0x00

---- Port Status ----
0x06  0x06  0x06  0x06

---- Power Status ----
0x00

-----
---- Event Registers ---- Dev : 01-----
0x00  0x0C  0x00  0x00  0x00

---- Port Status ----
0x44  0xB4  0x06  0x06

---- Power Status ----
0x33
  
```

Figure 4-7. Semi-Auto UART Transmission Status

4.4 MSP430 Reference Code

4.4.1 Overview

There is MSP430 reference code for basic applications published on ti.com. This reference code will be discussed in the following sections.

The system software supports the following features:

- IEEE802.3bt PoE specification
- Device detection, connection check, and classification
- Automatic power on (standard 2-pair PDs)
- DC disconnect
- Port telemetry updates

The MSP430 communicates with the PC through UART, reporting the parameter and status of the port.

4.4.2 Auto Mode

Auto mode operation is demonstrated in the MSP430 reference code and [Figure 4-8](#) shows the flow chart. Basically, after configuration, the TPS23882B1 handles port detection, classification, turn on, and faults by itself and there is no control needed from the host.

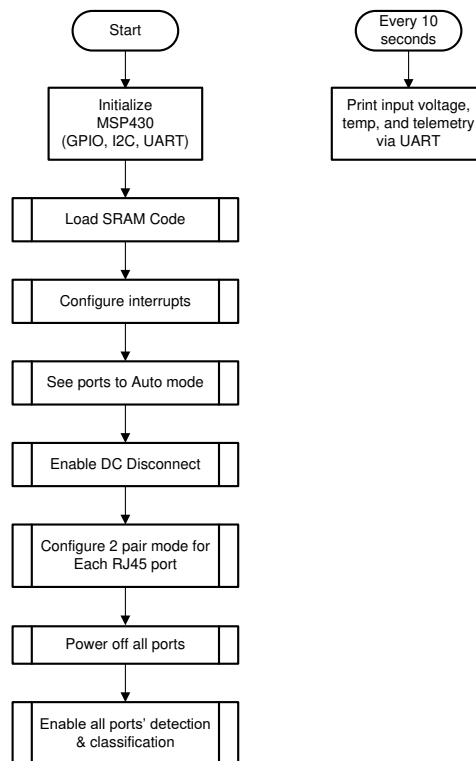

Figure 4-8. Auto Mode System Software Structure

4.4.3 Semi Auto Mode

Operation, the semi auto mode reference code is interrupt based. When MSP430 receives an interrupt from PSE's INT pin, the code checks interrupt the register and event registers to proceed with actions accordingly. The flowchart of semi auto mode code is shown in [Figure 4-9](#).

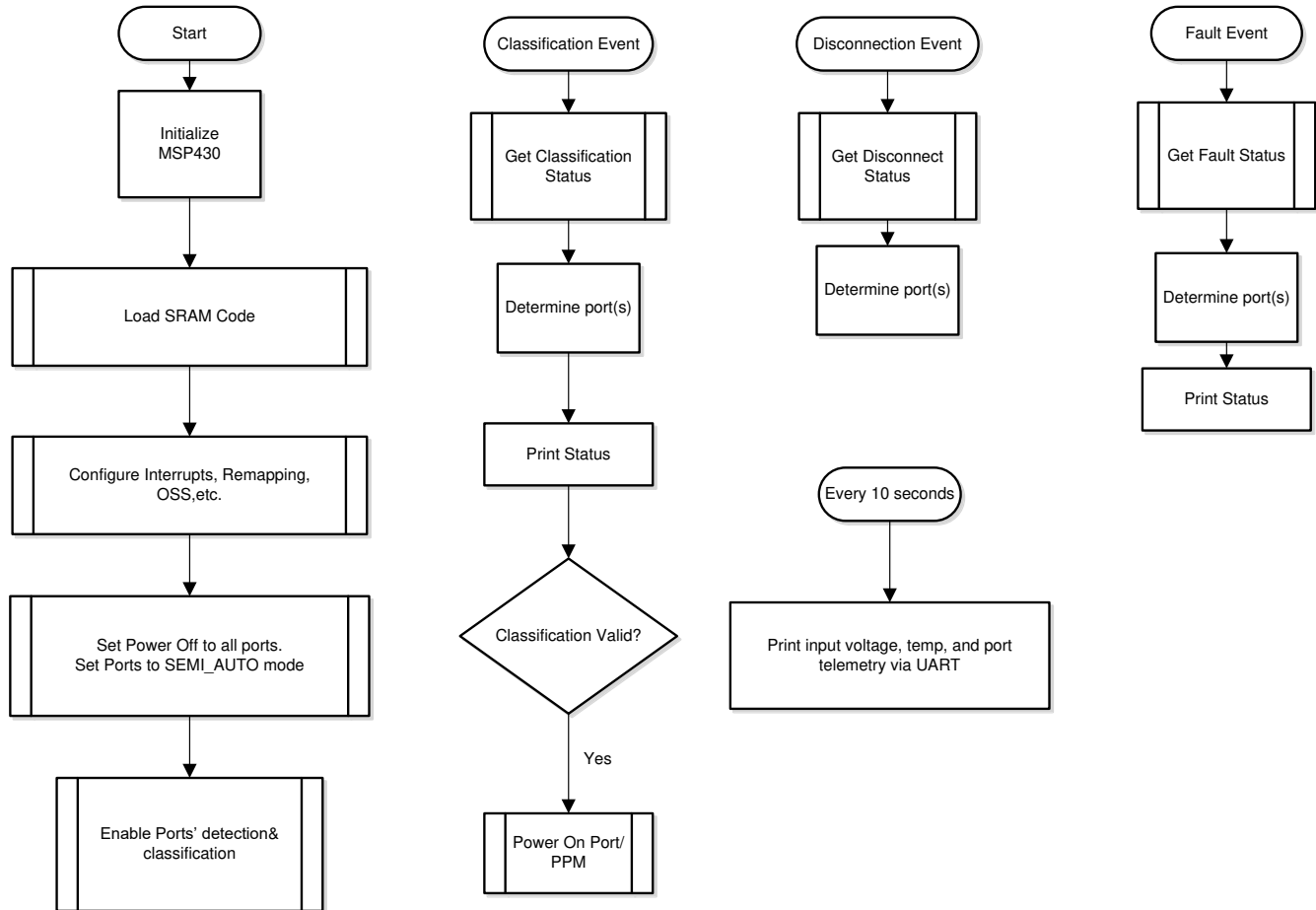

Figure 4-9. Semi Auto Mode System Software Structure

5 EVM Schematic, Layout Guidelines, PCB Assembly and Layer Plots

This section contains the TPS23882B1 schematic, layout guidelines, printed-circuit board (PCB) assembly and layer plots.

5.1 Schematic

Figure 5-1 through Figure 5-3 illustrate the TPS23882B1 (daughter card+motherboard) schematics.

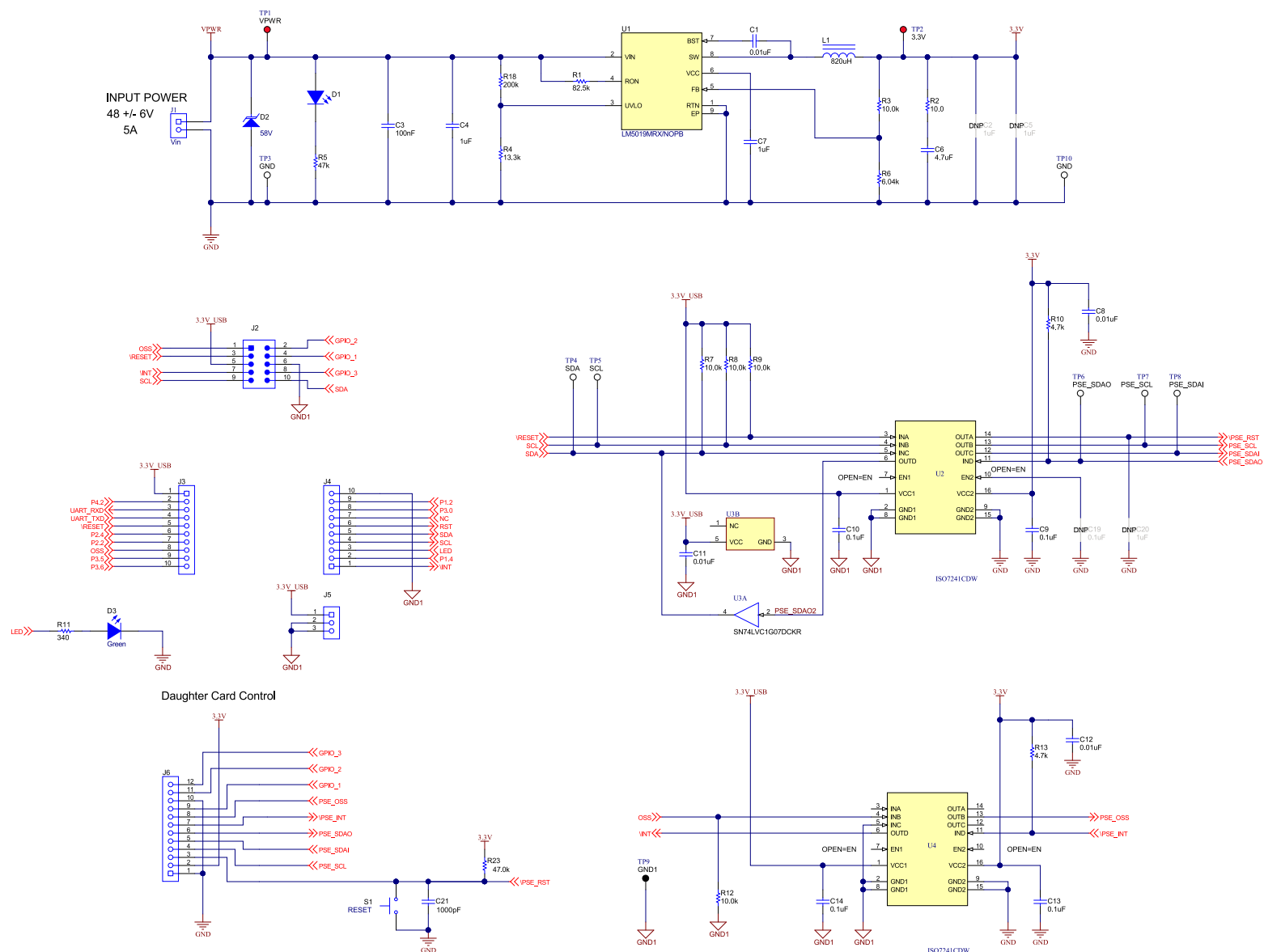

Figure 5-1. BOOST-PSEMTHR8-097 (Motherboard) Schematic: Control

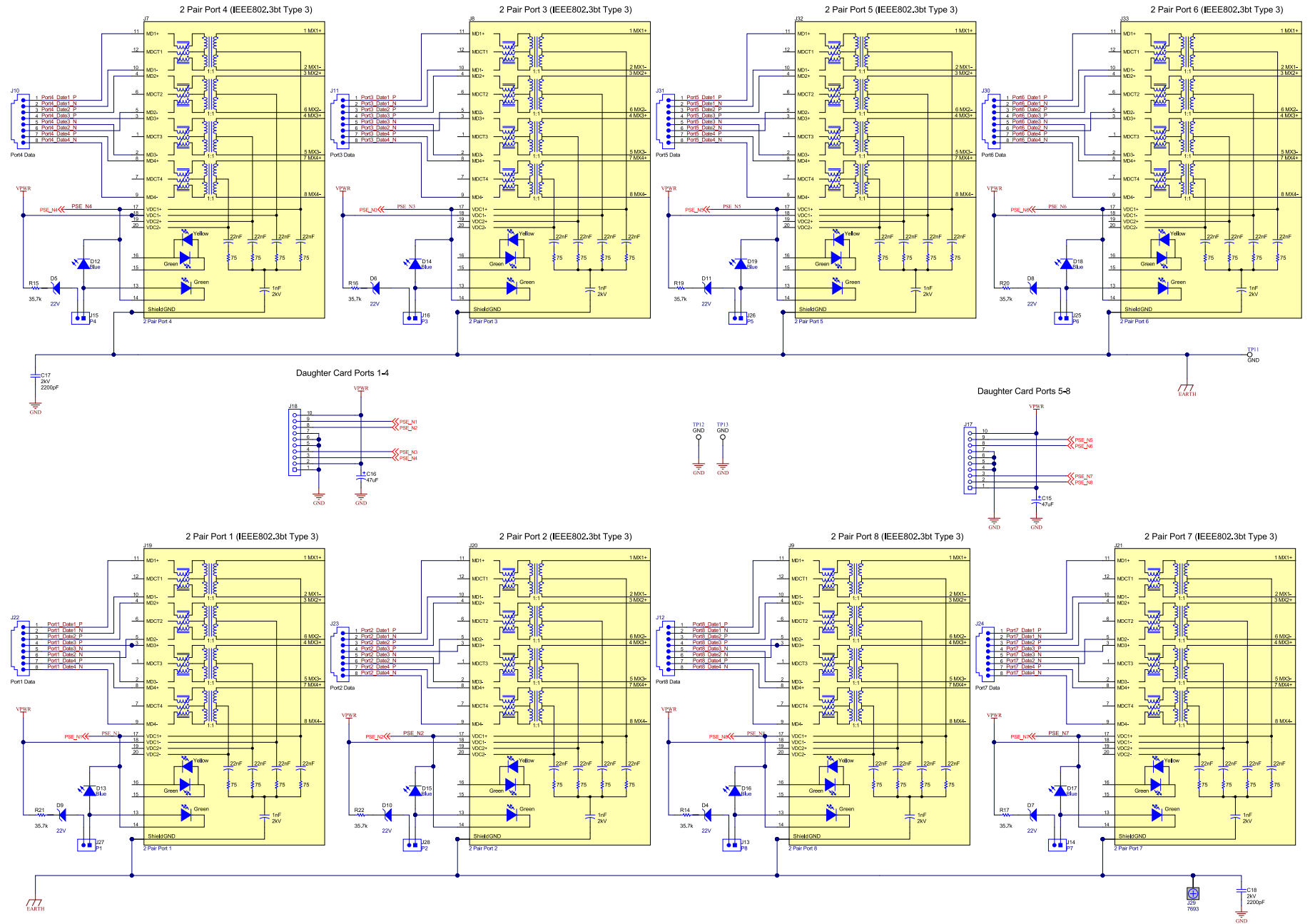

Figure 5-2. BOOST-PSEMTHR8-097 (Motherboard) Schematic: Power Ports

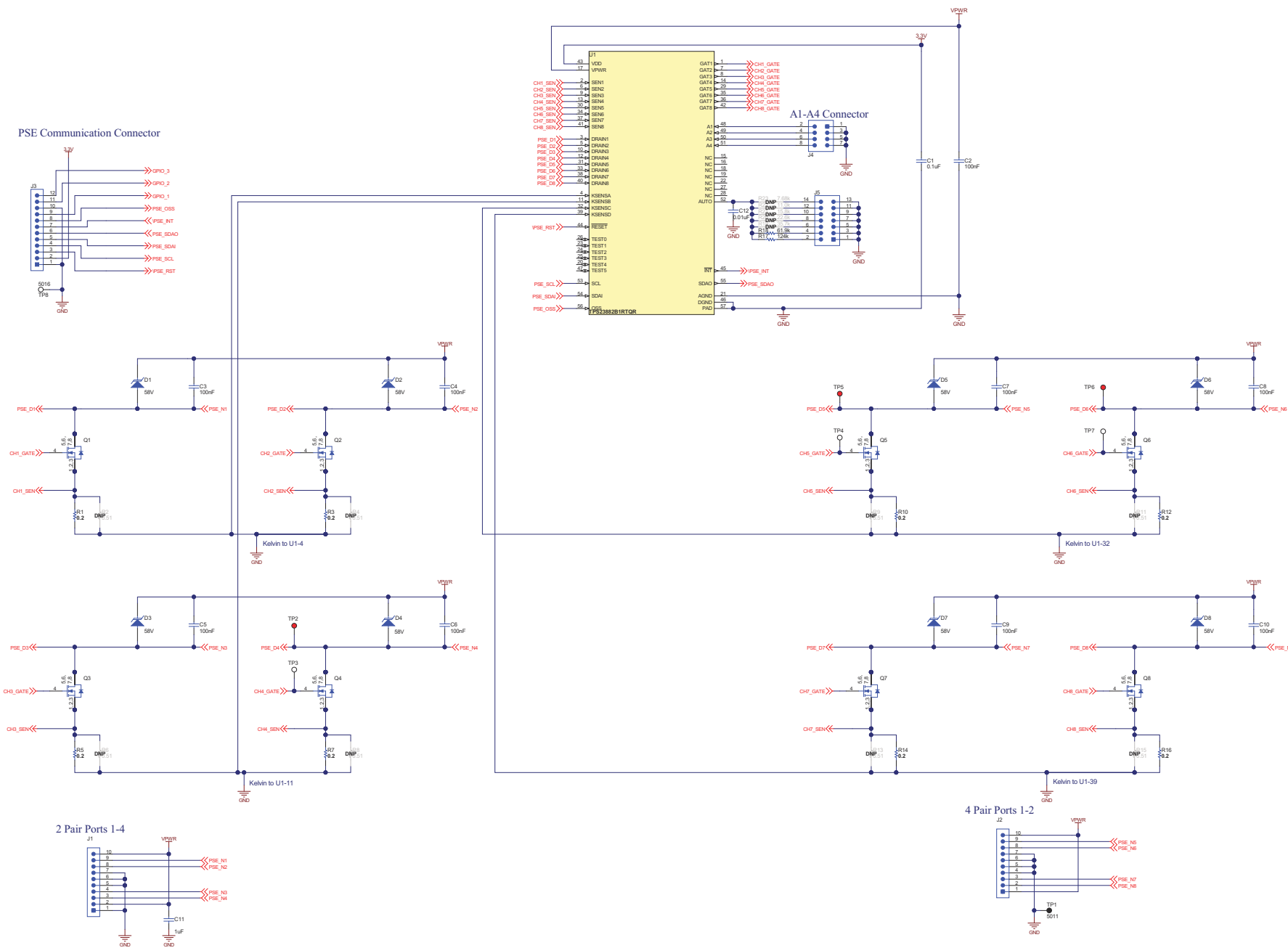

Figure 5-3. TPS23882B1EVM-008 (Daughterboard) Schematic

5.2 Layout Guidelines

5.2.1 Supply Voltage Decoupling

Provide power supply pin bypass to the TPS23882B1 device as follows:

- 0.1 μ F, 100 V, X7R ceramic at pin 28 (VPWR)
- 0.1 μ F, 50 V, X7R ceramic at pin 1 (VDD)

5.2.2 Port Current Kelvin Sensing

KSENSA is shared between SEN1 and SEN2, while KSENSB is shared between SEN3 and SEN4. In order to optimize the accuracy of the measurement, the PCB layout must be done carefully to minimize the impact of PCB trace resistance. Refer to [Figure 5-10](#) as an example.

5.2.3 Ground Plane Spacing and Isolation (GND, GND1, and EARTH nets)

Appropriate spacing should be provided between the GND, GND1, and EARTH nets as shown in [Figure 5-6](#).

5.3 PCB Drawings

[Figure 5-4](#) through [Figure 5-12](#) show the PCB layouts and assemblies for this EVM.

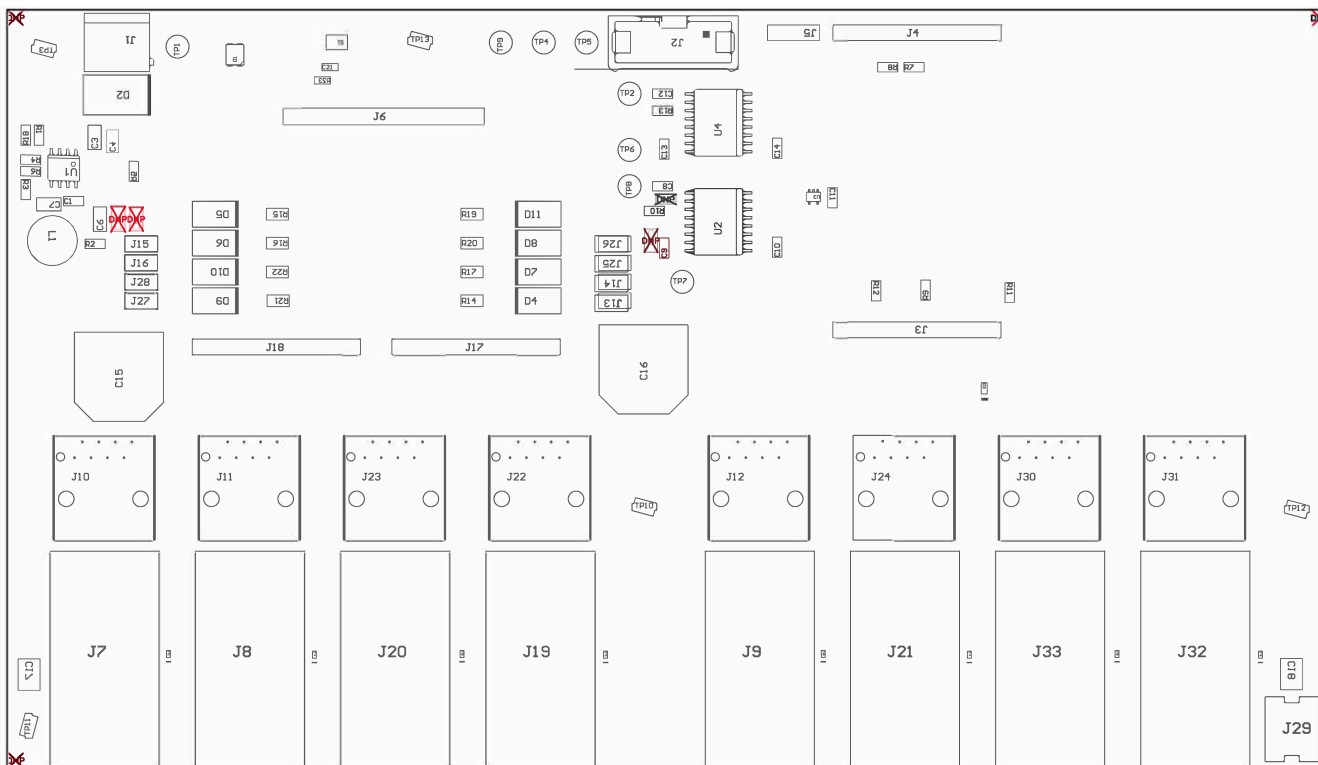

Figure 5-4. BOOST-PSEMTHR8-097 (Motherboard) Top Side Assembly

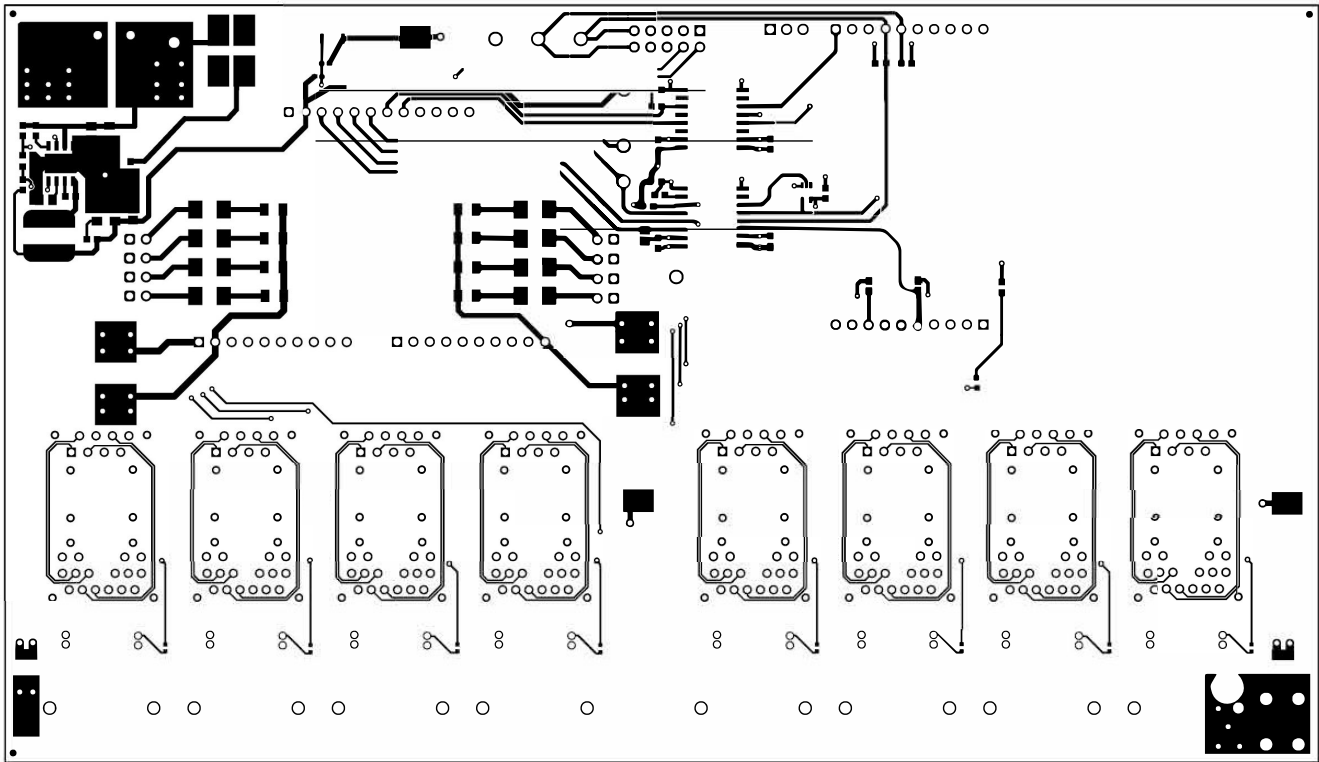

Figure 5-5. BOOST-PSEMTHR8-097 (Motherboard) Top Side Routing

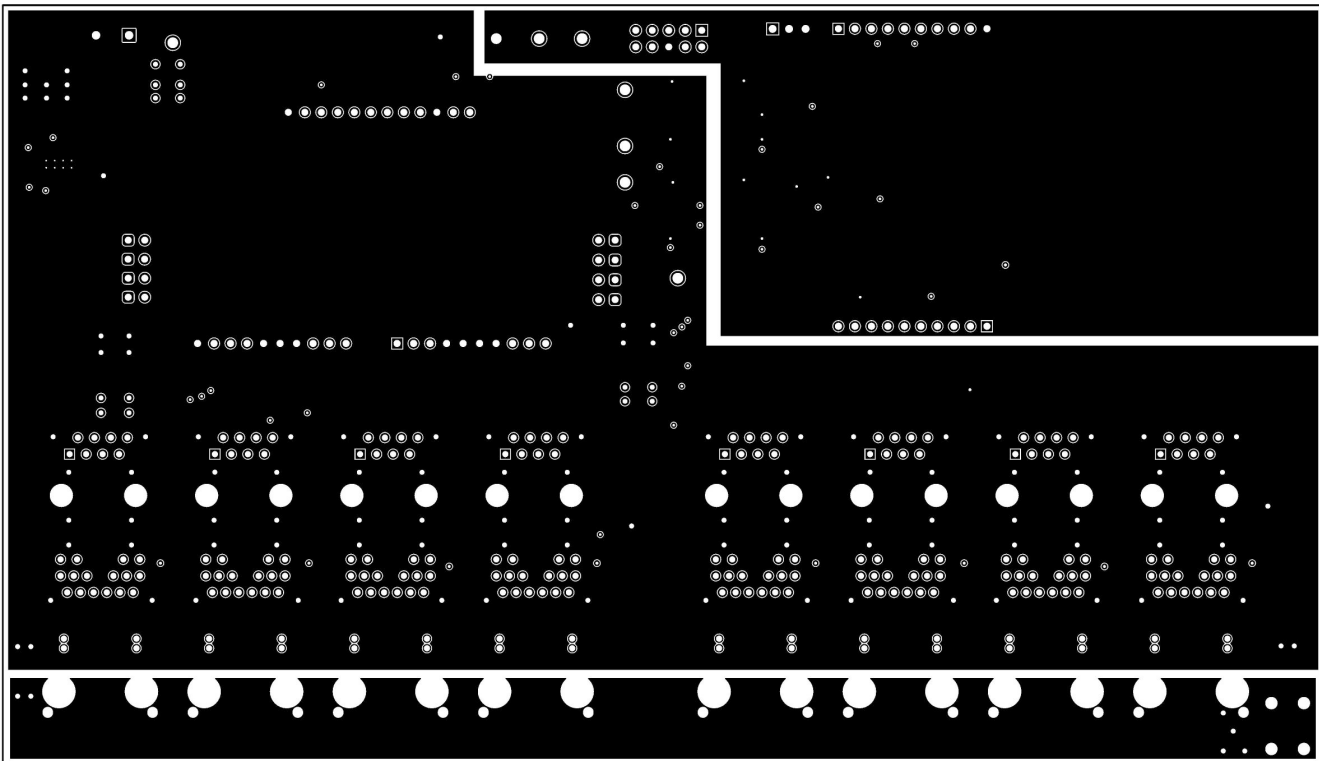

Figure 5-6. BOOST-PSEMTHR8-097 (Motherboard) Layer 2 Routing

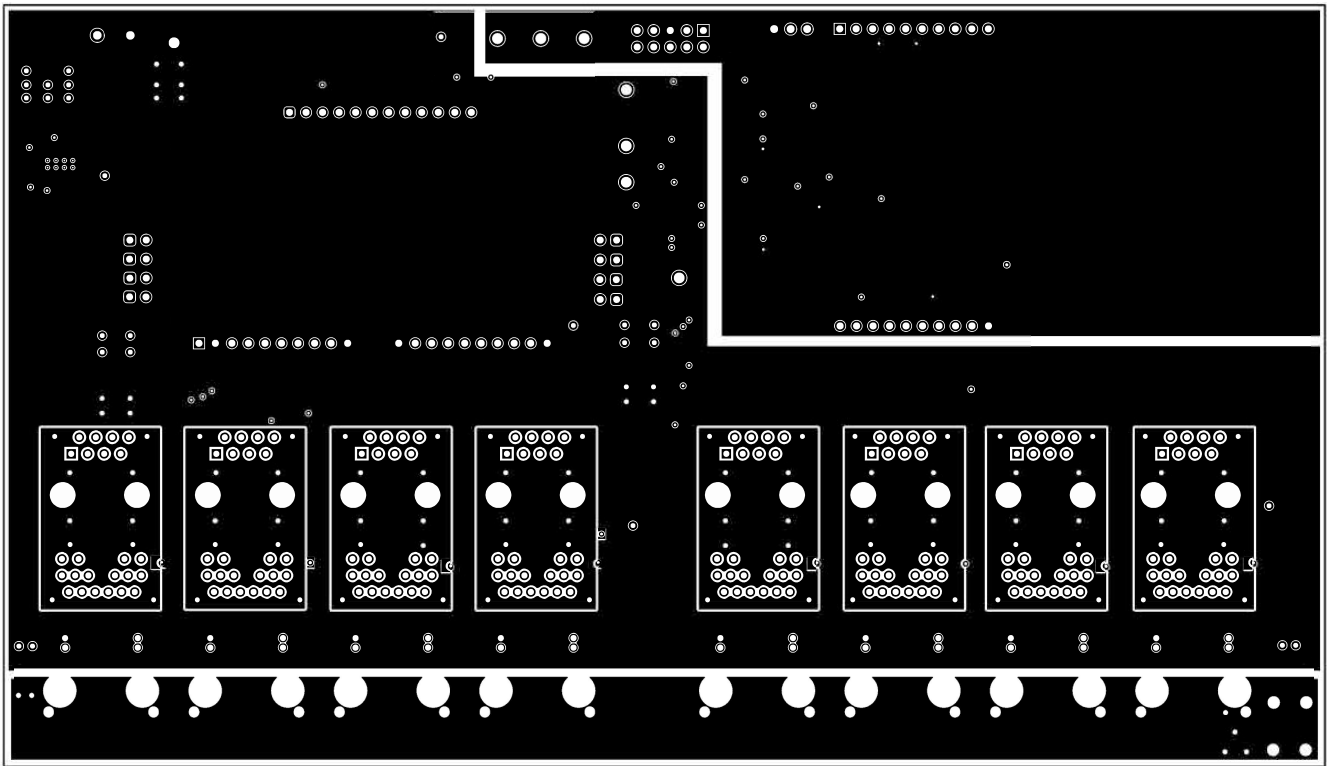

Figure 5-7. BOOST-PSEMTHR8-097 (Motherboard) Layer 3 Routing

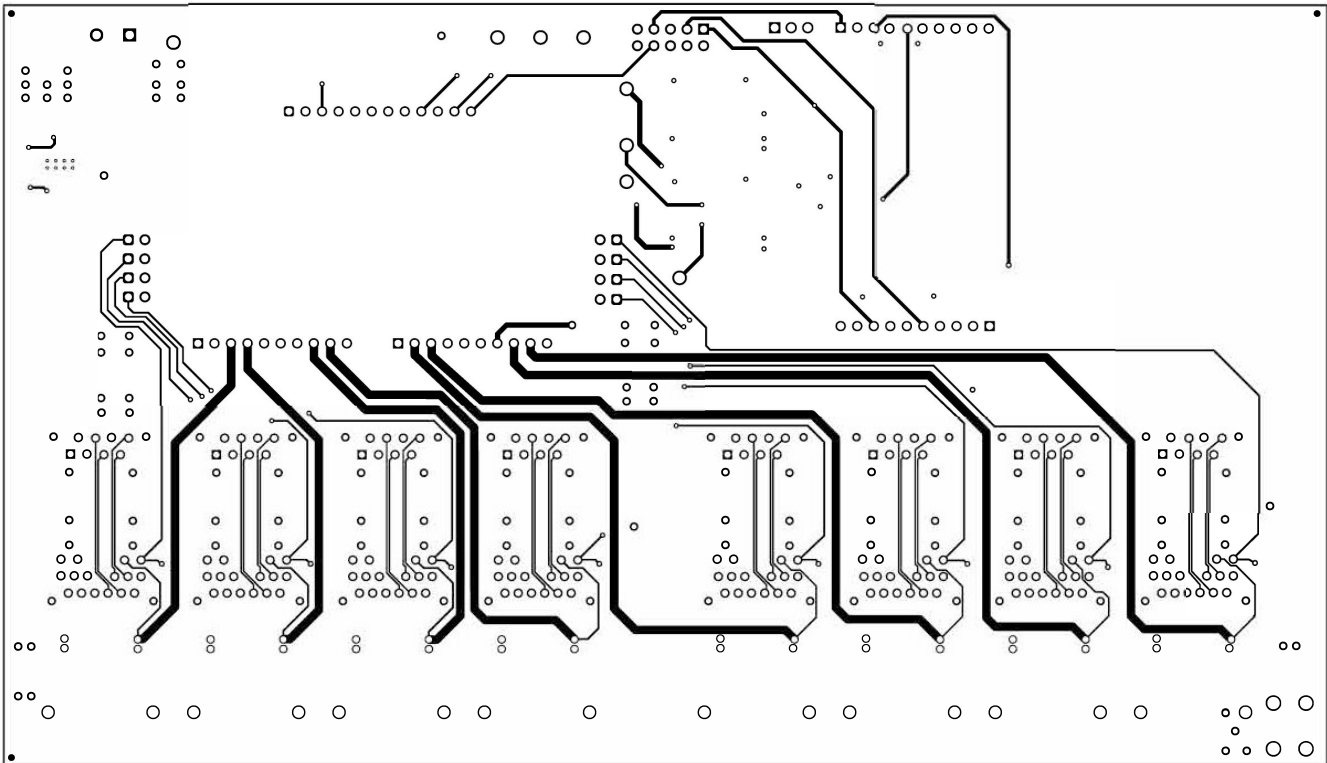

Figure 5-8. BOOST-PSEMTHR8-097 (Motherboard) Bottom Side Routing

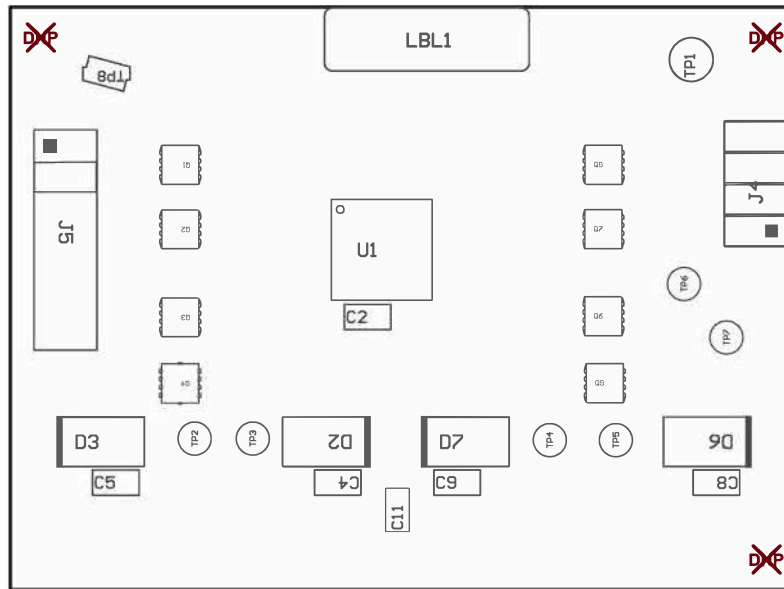

Figure 5-9. TPS23882B1EVM-008 (Daughterboard) Top Side Assembly

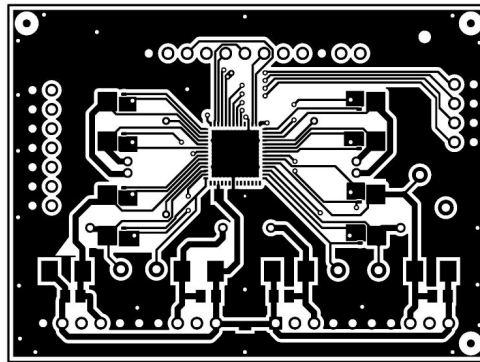

Figure 5-10. TPS23882B1EVM-008 (Daughterboard) Top Side Routing

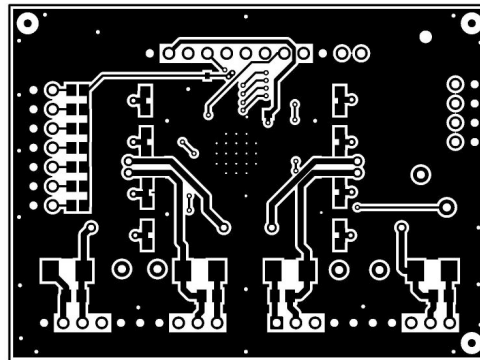

Figure 5-11. TPS23882B1EVM-008 (Daughterboard) Bottom Side Routing

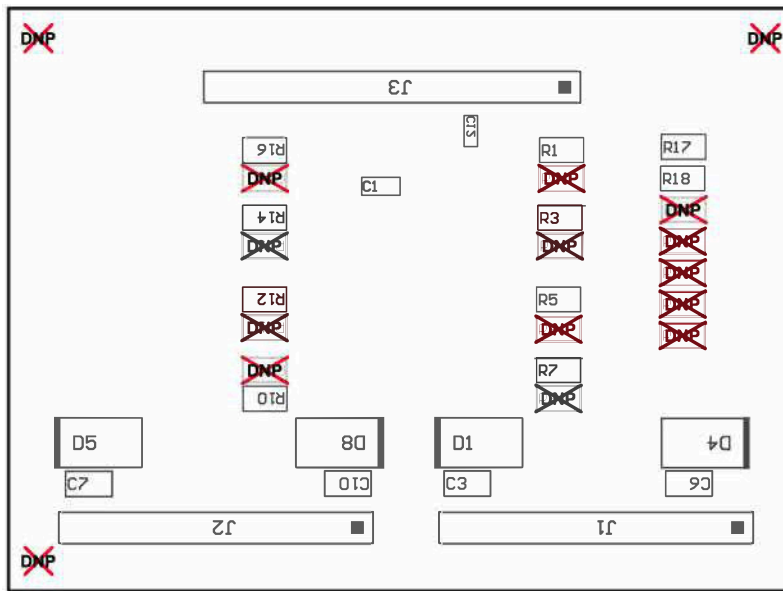

Figure 5-12. TPS23882B1EVM-008 (Daughterboard) Bottom Side Assembly

6 Bill of Materials

The BOMs for the BOOST-PSEMTHR8-097 and TPS23882B1EVM-008 are listed in [Table 6-1](#) and [Table 6-2](#).

Table 6-1. BOOST-PSEMTHR8-097 Bill of Materials⁽¹⁾

Designator	Quantity	Value	Description	Package Reference	Part Number	Manufacturer	Alternate Part Number	Alternate Manufacturer
!PCB	1		Printed Circuit Board		PSIL097	Any		
C1, C8, C11, C12	4	0.01 μ F	CAP, CERM, 0.01 μ F, 100 V, \pm 10%, X7R, 0603	0603	06031C103KAT2A	AVX		
C3	1	0.1 μ F	CAP, CERM, 0.1 μ F, 100 V, \pm 10%, X7R, 0805	0805	C2012X7R2A104K125A A	TDK		
C4	1	1 μ F	CAP, CERM, 1 μ F, 100 V, \pm 10%, X7R, 1206	1206	CL31B105KCHNNNE	Samsung		
C6	1	4.7 μ F	CAP, CERM, 4.7 μ F, 10 V, \pm 10%, X5R, 0805	0805	C0805C475K8PACTU	Kemet		
C7	1	1 μ F	CAP, CERM, 1 μ F, 10 V, \pm 10%, X7R, 0805	0805	0805ZC105KAT2A	AVX		
C9, C10, C13, C14	4	0.1 μ F	CAP, CERM, 0.1 μ F, 50 V, \pm 10%, X7R, 0603	0603	06035C104KAT2A	AVX		
C15, C16	2	47 μ F	CAP, AL, 47 μ F, 100 V, \pm 20%, 0.32 ohm, AEC-Q200 Grade 2, SMD	SMT Radial H13	EEV-FK2A470Q	Panasonic		
C17, C18	2	2200pF	CAP, CERM, 2200 pF, 2000 V, \pm 10%, X7R, 1812	1812	C4532X7R3D222K130K A	TDK		
C21	1	1000pF	CAP, CERM, 1000 pF, 50 V, \pm 10%, X7R, 0402	0402	885012205061	Würth Elektronik		
D1	1	White	LED, True Green, SMD	2.8x3.2mm	LT E6SG-AABB-35-1	OSRAM		
D2	1	58V	Diode, TVS, Uni, 58 V, 93.6 Vc, SMC	SMC	SMCJ58A-13-F	Diodes Inc.		
D3	1	Green	LED, Green, SMD	1.6x0.8x0.8mm	LTST-C190KGKT	Lite-On		
D4, D5, D6, D7, D8, D9, D10, D11	8	22V	Diode, Zener, 22 V, 550 mW, SMB	SMB	1SMB5933BT3G	ON Semiconductor		
D12, D13, D14, D15, D16, D17, D18, D19	8	Blue	LED, Blue, SMD	1x0.5mm	LB QH9G-N100-35-1	OSRAM		
H1, H2, H3, H4, H5, H6, H7, H8, H9	9		Bumpon, Cylindrical, 0.312 X 0.200, Black	Black Bumpon	SJ61A1	3M		
J1	1		Terminal Block, 5.08 mm, 2x1, Brass, TH	2x1 5.08 mm Terminal Block	ED120/2DS	On-Shore Technology		
J2	1		Header (shrouded), 100mil, 5x2, High-Temperature, Gold, TH	5x2 Shrouded header	N2510-6002-RB	3M		
J3, J4, J17, J18	4		Receptacle, 2.54mm, 10x1, Tin, TH	Receptacle, 2.54mm, 10x1, TH	SSW-110-01-T-S	Samtec		
J5	1		Receptacle, 100mil, 3x1, Gold, TH	3x1 Receptacle	SSW-103-01-G-S	Samtec		
J6	1		Receptacle, 2.54mm, 12x1, Gold, TH	Receptacle, 2.54mm, 12x1, TH	PPPC121LFBN-RC	Sullins Connector Solutions		

Table 6-1. BOOST-PSEMTHR8-097 Bill of Materials⁽¹⁾ (continued)

Designator	Quantity	Value	Description	Package Reference	Part Number	Manufacturer	Alternate Part Number	Alternate Manufacturer
J7, J8, J9, J19, J20, J21, J32, J33	8		RJ45 with integrated magnetics	RJ-45 Jack	JK0-0177NL	Pulse Engineering		
J10, J11, J12, J22, J23, J24, J30, J31	8		RJ45, Vertical, TH	RJ-45 Jack, 8Pos Right Angle	SS-7188V-A-NF	Stewart Connector		
J13, J14, J15, J16, J25, J26, J27, J28	8		Header, 100mil, 2x1, Gold, TH	2x1 Header	TSW-102-07-G-S	Samtec		
J29	1		Terminal screw, vertical, snap-in	7693	7693	Keystone		
L1	1	820uH	Inductor, Drum Core, Ferrite, 820 uH, 0.23 A, 4 ohm, SMD	SDR0805	SDR0805-821KL	Bourns	768775282	Würth Electronics
R1	1	82.5k	RES, 82.5 k, 1%, 0.1 W, AEC-Q200 Grade 0, 0603	0603	CRCW060382K5FKEA	Vishay-Dale		
R2	1	10.0	RES, 10.0, 1%, 0.1 W, AEC-Q200 Grade 0, 0603	0603	CRCW060310R0FKEA	Vishay-Dale		
R3, R7, R8, R9, R12	5	10.0k	RES, 10.0 k, 1%, 0.1 W, AEC-Q200 Grade 0, 0603	0603	CRCW060310K0FKEA	Vishay-Dale		
R4	1	13.3k	RES, 13.3 k, 1%, 0.1 W, AEC-Q200 Grade 0, 0603	0603	CRCW060313K3FKEA	Vishay-Dale		
R5	1	47k	RES, 47 k, 5%, 0.1 W, AEC-Q200 Grade 0, 0603	0603	CRCW060347K0JNEA	Vishay-Dale		
R6	1	6.04k	RES, 6.04 k, 1%, 0.1 W, AEC-Q200 Grade 0, 0603	0603	CRCW06036K04FKEA	Vishay-Dale		
R10, R13	2	4.7k	RES, 4.7 k, 5%, 0.1 W, AEC-Q200 Grade 0, 0603	0603	CRCW06034K70JNEA	Vishay-Dale		
R11	1	340	RES, 340, 1%, 0.1 W, AEC-Q200 Grade 0, 0603	0603	CRCW0603340RFKEA	Vishay-Dale		
R14, R15, R16, R17, R19, R20, R21, R22	8	35.7k	RES, 35.7 k, 1%, 0.25 W, AEC-Q200 Grade 0, 1206	1206	CRCW120635K7FKEA	Vishay-Dale		
R18	1	200k	RES, 200 k, 1%, 0.1 W, AEC-Q200 Grade 0, 0603	0603	CRCW0603200KFKEA	Vishay-Dale		
R23	1	47.0k	RES, 47.0 k, 1%, 0.0625 W, 0402	0402	RC0402FR-0747KL	Yageo America		
S1	1		Switch, SPST-NO, 0.05 A, 12 VDC, SMT	3x2mm	TL3780AF330QG	E-Switch		
SH-J1, SH-J2, SH-J3, SH-J4, SH-J5, SH-J6, SH-J7, SH-J8	8	1x2	Shunt, 100mil, Flash Gold, Black	Closed Top 100mil Shunt	SPC02SYAN	Sullins Connector Solutions		
TP1, TP2	2		Test Point, Multipurpose, Red, TH	Red Multipurpose Testpoint	5010	Keystone		
TP3, TP10, TP11, TP12, TP13	5		Test Point, Compact, SMT	Testpoint_Keystone_C ompact	5016	Keystone		
TP4, TP5, TP6, TP7, TP8	5		Test Point, Multipurpose, White, TH	White Multipurpose Testpoint	5012	Keystone		

Table 6-1. BOOST-PSEMTHR8-097 Bill of Materials⁽¹⁾ (continued)

Designator	Quantity	Value	Description	Package Reference	Part Number	Manufacturer	Alternate Part Number	Alternate Manufacturer
TP9	1		Test Point, Multipurpose, Black, TH	Black Multipurpose Testpoint	5011	Keystone		
U1	1		7.5-100V Wide Vin, 100mA Constant On-Time Synchronous Buck Regulator, DDA0008B (SOIC-8)	DDA0008B	LM5019MRX/NOPB	Texas Instruments	LM5019MR/NOPB	Texas Instruments
U2, U4	2		2.5 kVrms, 25 Mbps, 4-Channel 3/1 Digital Isolator, DW0016B (SOIC-16)	DW0016B	ISO7241CDW	Texas Instruments		
U3	1		Single Buffer/Driver With Open-Drain Output, DCK0005A, LARGE T&R	DCK0005A	SN74LVC1G07DCKR	Texas Instruments		
C2, C5, C20	0	1 μ F	CAP, CERM, 1 μ F, 10 V, \pm 10%, X7R, 0805	0805	0805ZC105KAT2A	AVX		
C19	0	0.1 μ F	CAP, CERM, 0.1 μ F, 50 V, \pm 10%, X7R, 0603	0603	06035C104KAT2A	AVX		
FID1, FID2, FID3, FID4, FID5, FID6	0		Fiducial mark. There is nothing to buy or mount.	N/A	N/A	N/A		

(1) Unless otherwise noted in the *Alternate Part Number* or *Alternate Manufacturer* columns, all parts may be substituted with equivalents.

Table 6-2. TPS23882B1EVM-008 Bill of Material

QTY	Value	Description	Package Reference	Part Number	Manufacturer	Alternate Part Number ⁽¹⁾	Alternate Manufacturer ⁽¹⁾
1		Printed Circuit Board		PSIL008	Any		
1	0.1 μ F	CAP, CERM, 0.1 μ F, 50 V, \pm 10%, X7R, 0603	0603	06035C104KAT2A	AVX		
9	0.1 μ F	CAP, CERM, 0.1 μ F, 100 V, \pm 10%, X7R, 0805	0805	C2012X7R2A104K125AA	TDK		
1	1 μ F	CAP, CERM, 1 μ F, 100 V, \pm 10%, X7R, 1206	1206	C3216X7R2A105K160AA	TDK		
1	0.01 μ F	CAP, CERM, 0.01 μ F, 16 V, \pm 10%, X7R, 0402	0402	520L103KT16T	AT Ceramics		
8	58V	Diode, TVS, Uni, 58 V, 93.6 Vc, SMB	SMB	SMBJ58A-13-F	Diodes Inc.		
2		Header, 100mil, 10x1, Gold, TH	10x1 Header	TSW-110-07-G-S	Samtec		
1		Header, 100mil, 12x1, Gold, TH	12x1 Header	TSW-112-07-G-S	Samtec		
1		Header, 100mil, 4x2, Gold, TH	4x2 Header	TSW-104-07-G-D	Samtec		
1		Header, 100mil, 7x2, Gold, TH	7x2 Header	TSW-107-07-G-D	Samtec		
1		Thermal Transfer Printable Labels, 0.650" W x 0.200" H - 10,000 per roll	PCB Label 0.650 x 0.200 inch	THT-14-423-10	Brady		
8	100V	MOSFET, N-CH, 100 V, 5 A, DNH0008A (VSONP-8)	DNH0008A	CSD19538Q3A	Texas Instruments		None
8	0.2	RES, 0.2, 1%, 0.333 W, 0805	0805	RL1220S-R20-F	Susumu Co Ltd		
1	124k	RES, 124 k, 1%, 0.125 W, AEC-Q200 Grade 0, 0805	0805	CRCW0805124KFKEA	Vishay-Dale		
1	61.9k	RES, 61.9 k, 1%, 0.125 W, AEC-Q200 Grade 0, 0805	0805	CRCW080561K9FKEA	Vishay-Dale		
5	1x2	Shunt, 100mil, Flash Gold, Black	Closed Top 100mil Shunt	SPC02SYAN	Sullins Connector Solutions		
1		Test Point, Multipurpose, Black, TH	Black Multipurpose Testpoint	5011	Keystone		
3		Test Point, Miniature, Red, TH	Red Miniature Testpoint	5000	Keystone		
3		Test Point, Miniature, White, TH	White Miniature Testpoint	5002	Keystone		
1		Test Point, Compact, SMT	Testpoint_Keystone_Compact	5016	Keystone		
1		High-Power, 8-Channel, Power-Over-Ethernet PSE With 200-mO RSENSE, RTQ0056E (VQFN-56)	RTQ0056E	TPS23882B1RTQR	Texas Instruments	TPS23882B1RTQT	Texas Instruments
0		Fiducial mark. There is nothing to buy or mount.	N/A	N/A	N/A		

Table 6-2. TPS23882B1EVM-008 Bill of Material (continued)

QTY	Value	Description	Package Reference	Part Number	Manufacturer	Alternate Part Number ⁽¹⁾	Alternate Manufacturer ⁽¹⁾
0	0.51	RES, 0.51, 1%, 0.25 W, 0805	0805	CRM0805-FX-R510ELF	Bourns		
0	35.7k	RES, 35.7 k, 1%, 0.125 W, AEC-Q200 Grade 0, 0805	0805	ERJ-6ENF3572V	Panasonic		
0	22.6k	RES, 22.6 k, 1%, 0.125 W, AEC-Q200 Grade 0, 0805	0805	ERJ-6ENF2262V	Panasonic		
0	15.8k	RES, 15.8 k, 1%, 0.125 W, AEC-Q200 Grade 0, 0805	0805	ERJ-6ENF1582V	Panasonic		
0	11.0k	RES, 11.0 k, 1%, 0.125 W, AEC-Q200 Grade 0, 0805	0805	ERJ-6ENF1102V	Panasonic		
0	7.68k	RES, 7.68 k, 1%, 0.125 W, AEC-Q200 Grade 0, 0805	0805	ERJ-6ENF7681V	Panasonic		

(1) Unless otherwise noted in the *Alternate Part Number* or *Alternate Manufacturer* columns, all parts may be substituted with equivalents.

IMPORTANT NOTICE AND DISCLAIMER

TI PROVIDES TECHNICAL AND RELIABILITY DATA (INCLUDING DATA SHEETS), DESIGN RESOURCES (INCLUDING REFERENCE DESIGNS), APPLICATION OR OTHER DESIGN ADVICE, WEB TOOLS, SAFETY INFORMATION, AND OTHER RESOURCES "AS IS" AND WITH ALL FAULTS, AND DISCLAIMS ALL WARRANTIES, EXPRESS AND IMPLIED, INCLUDING WITHOUT LIMITATION ANY IMPLIED WARRANTIES OF MERCHANTABILITY, FITNESS FOR A PARTICULAR PURPOSE OR NON-INFRINGEMENT OF THIRD PARTY INTELLECTUAL PROPERTY RIGHTS.

These resources are intended for skilled developers designing with TI products. You are solely responsible for (1) selecting the appropriate TI products for your application, (2) designing, validating and testing your application, and (3) ensuring your application meets applicable standards, and any other safety, security, regulatory or other requirements.

These resources are subject to change without notice. TI grants you permission to use these resources only for development of an application that uses the TI products described in the resource. Other reproduction and display of these resources is prohibited. No license is granted to any other TI intellectual property right or to any third party intellectual property right. TI disclaims responsibility for, and you will fully indemnify TI and its representatives against, any claims, damages, costs, losses, and liabilities arising out of your use of these resources.

TI's products are provided subject to [TI's Terms of Sale](#) or other applicable terms available either on ti.com or provided in conjunction with such TI products. TI's provision of these resources does not expand or otherwise alter TI's applicable warranties or warranty disclaimers for TI products.

TI objects to and rejects any additional or different terms you may have proposed.

Mailing Address: Texas Instruments, Post Office Box 655303, Dallas, Texas 75265
Copyright © 2022, Texas Instruments Incorporated