



DS15BR400EVK

**Quad LVDS Buffer/Repeater with Pre-
emphasis**

Evaluation Kit User Manual

Overview

DS15BR400 is a four channel LVDS Buffer/Repeater, featuring pre-emphasis with maximum pre-emphasis gain of approximately 6 dB at 750 MHz. The device has internal 100-ohm resistors on both, the inputs and outputs, to improve performance and minimize board size. It utilizes LVDS technology for low power, high-speed and superior noise immunity.

The purpose of this document is to familiarize you with the DS15BR400 Evaluation Board (DS15BR400EVK), suggest the test setup procedures and instrumentation, and to guide you through some typical measurements that will demonstrate the performance of the device.

Description

Figure 1 below represents the top layer drawing of the board with the silkscreen annotations. It is a four by four inch six layer printed circuit board (PCB) that has a single-device layout capable of demonstrating performance and all functions of the DS15BR400.

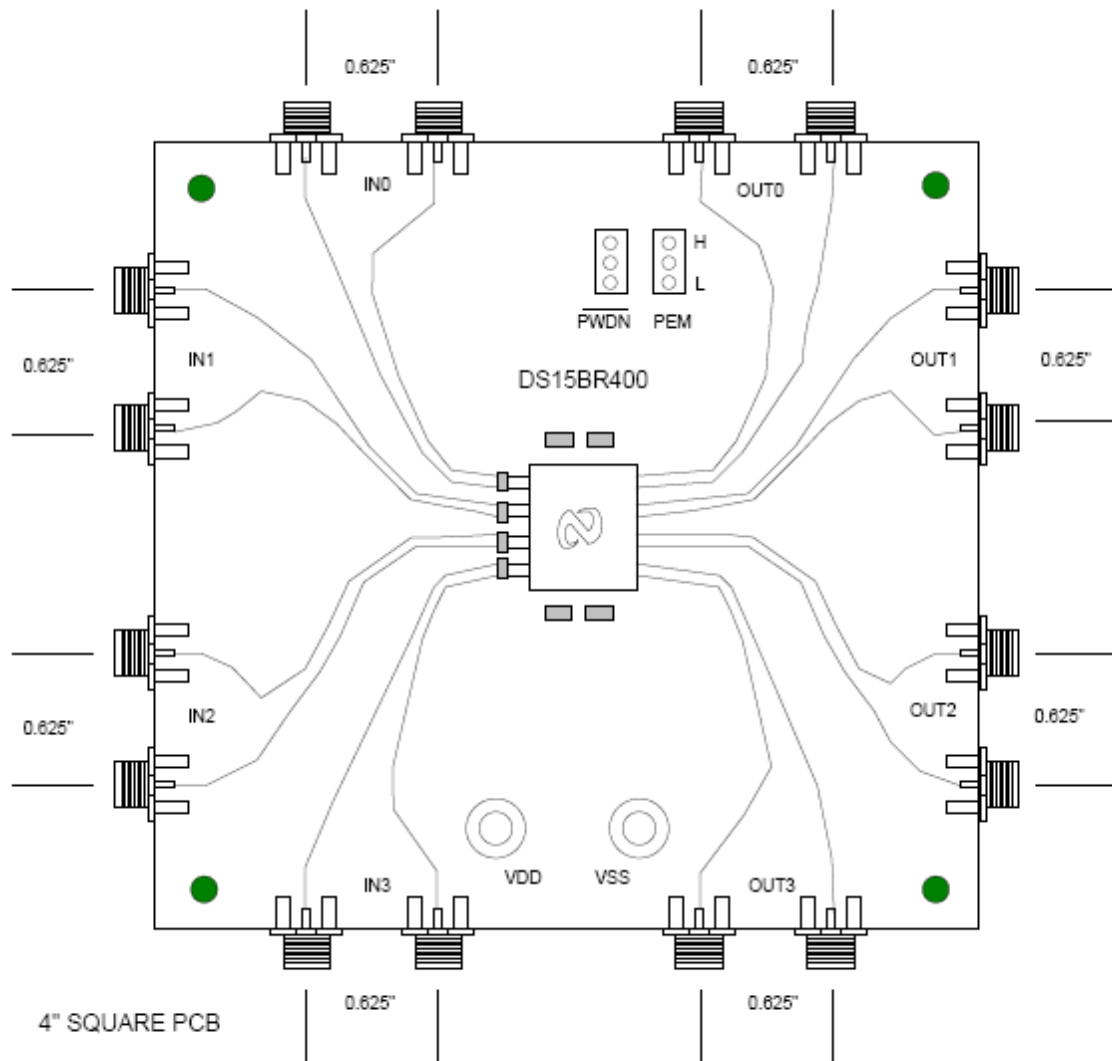

Figure 1: DS15BR400 Evaluation Board - Top View

All LVDS inputs and outputs are accessible through SMA connectors and suitable for connections to 50-ohm instrumentation. The power can be applied using banana plugs. The control pins, PWDN* and PEM pins, are connected to 2-position switches.

Test Setup Procedure

The following is a recommended test setup procedure for the device evaluation. Figure 2 depicts a typical setup and instrumentation used for the device evaluation.

1. Apply the power to the device (3.3V typical) between VDD and VSS banana plug receptacles, observe the value of I_{CC} , and compare it with the expected value (refer to the datasheet) to ensure that the device is functional.
2. Select I/O pairs you want to evaluate. For example, let's say that we want to evaluate the IN0 to OUT0 signal path of the DS15BR400. The setup instructions that follow are based on this selection.
3. Connect a signal source (i.e. signal generator or an LVDS driver) to the IN0 inputs on the board and adjust the signal parameters (V_{OH} , V_{OL} , V_{CM}) so that they comply with the device input recommendations.
4. Enable the DS15BR400 by setting PWDN* to high on CON1. Optionally, you may turn the pre-emphasis on for this output by setting PEM to "H" position on CON2.
5. Connect the OUT0 outputs to an oscilloscope and view the output signals with an oscilloscope with the bandwidth of at least 3 GHz.

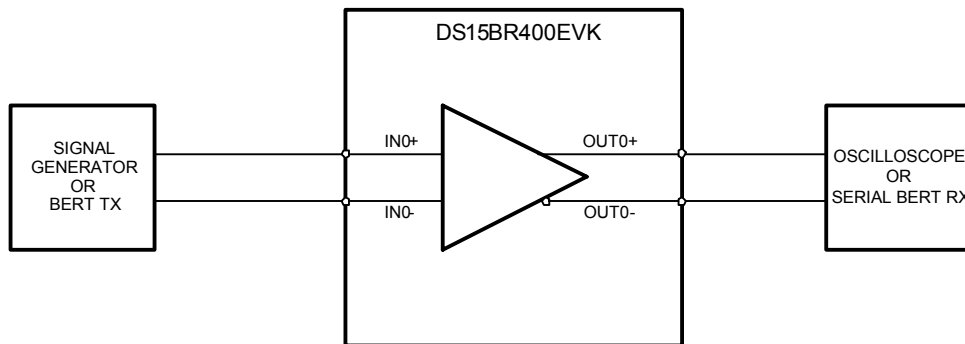

Figure 2. Typical Test Setup

Figure 3 and 4 show an output eye diagram obtained using the DS15BR400EVK setup as in figure 2. The input was 400mV in amplitude with 1.2 V common mode voltage 1.5 Gbps NRZ PRBS-23.

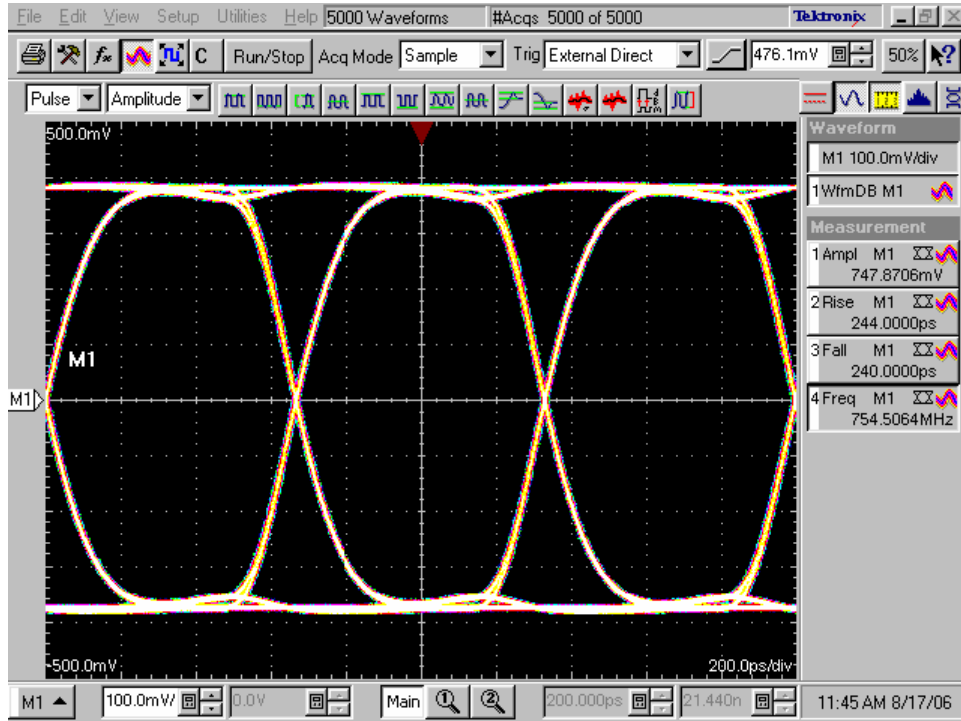

Figure 3. DS15BR400– Output Eye Diagram, Pre-emphasis OFF

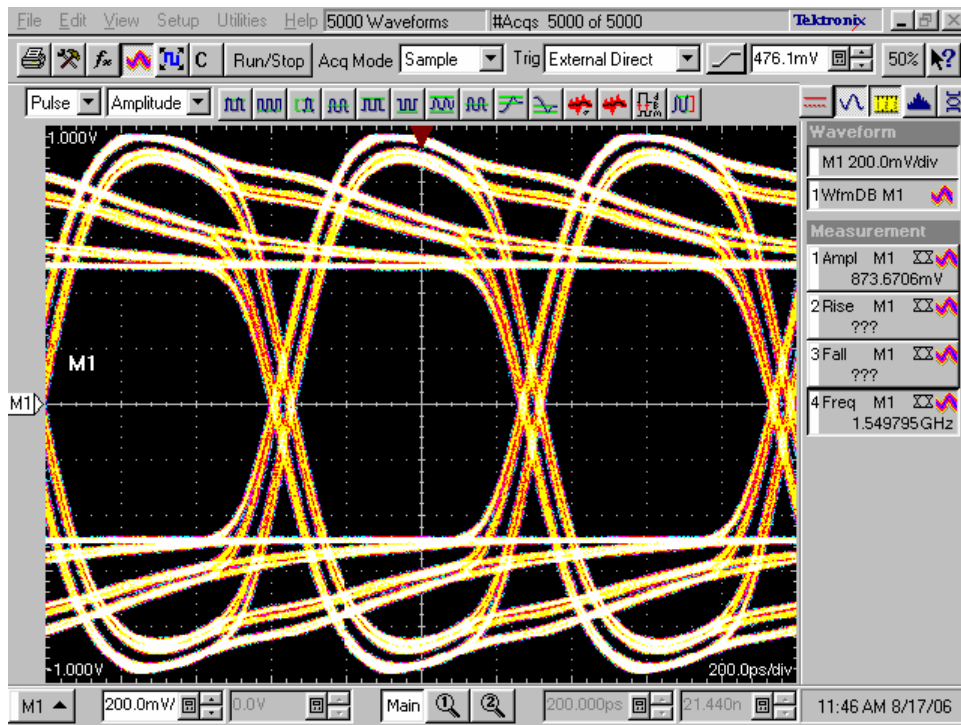

Figure 4. DS15BR400 – Output Eye Diagram, Pre-emphasis On

Figures 5 and 6 show the eye diagrams obtained at 2 Gbps with NRZ PRBS-23.

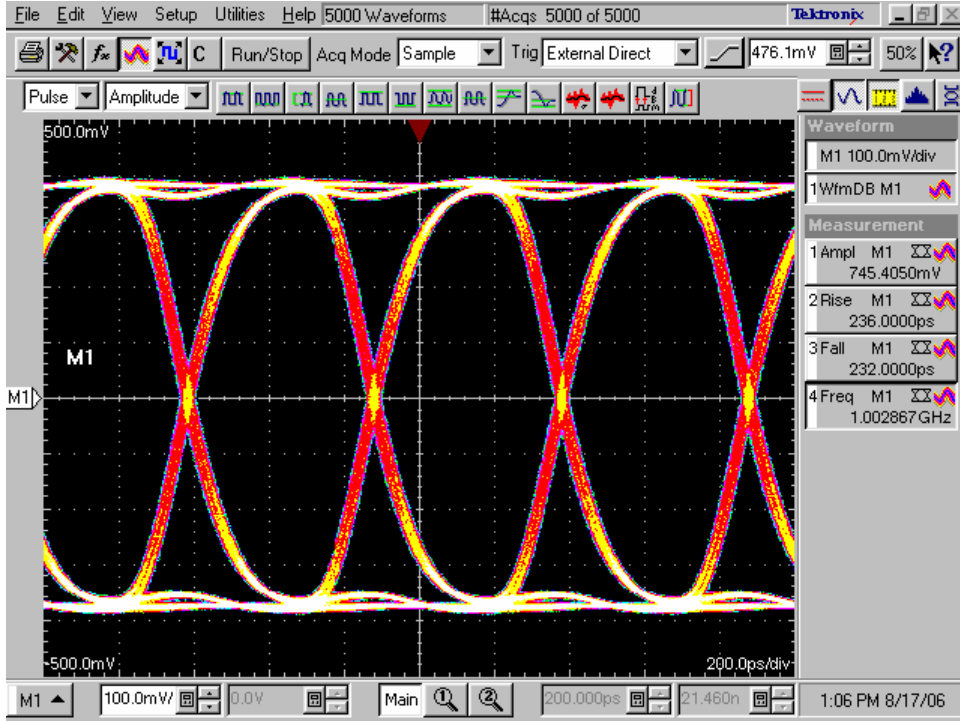

Figure 5. DS15BR400– Output Eye Diagram, Pre-emphasis OFF

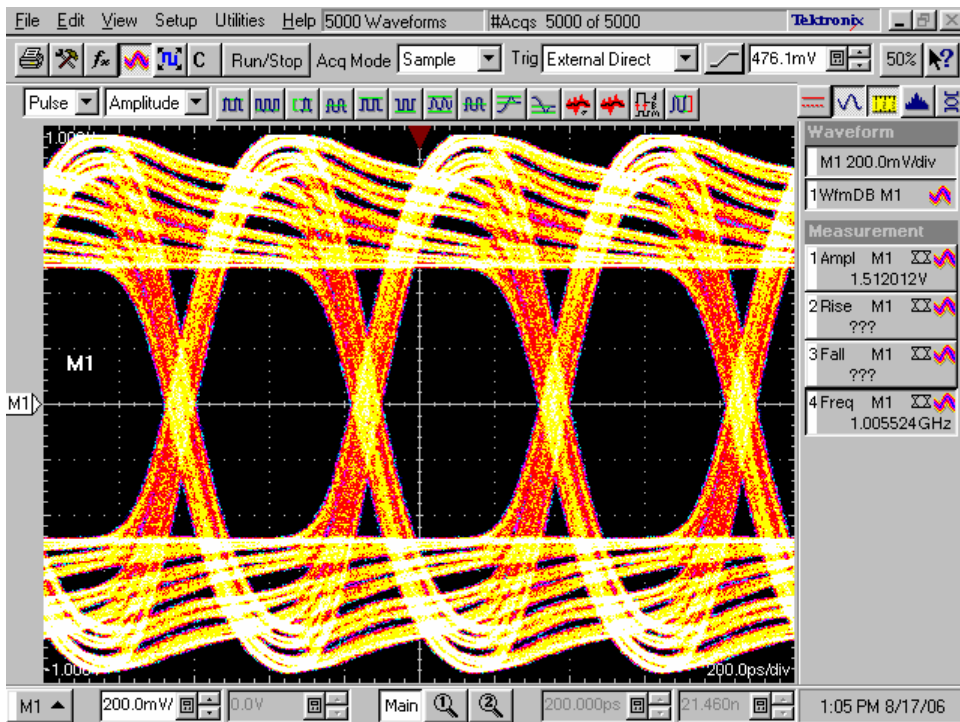
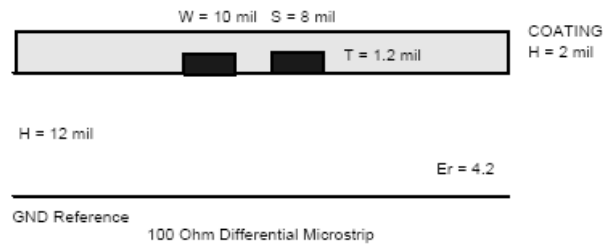
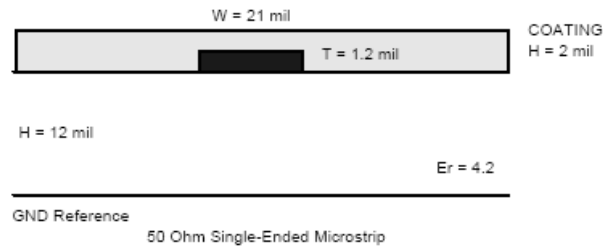
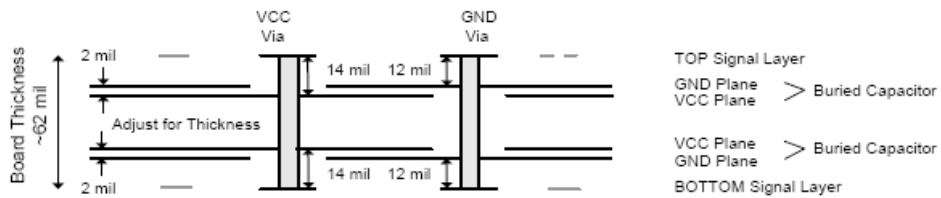

Figure 6. DS15BR400 – Output Eye Diagram, Pre-emphasis On

Bill Of Materials

DS15BR400 APPLICATION EVALUATION BOARD							
Revised: May 21, 2006							
Item	Part Type	Part Number	Mfg	Description	Qty	Ref Des	Notes
1	CONN		ANY	HEADER3X1	2	CON1,CON2	
2	CONN	50F1460	NEWARK	JACK, Banana Plug Receptacle	2	CON3,CON4	
3	CAP		ANY	0.01 μ F, \pm 10%, 0603	2	C1,C4	
4	CAP		ANY	0.001 μ F, \pm 10%, 0603	1	C2	
5	CAP		ANY	0.1 μ F, \pm 10%, 0603	1	C3	
6	CAP		ANY	22 μ F, \pm 10%, 7343	1	C5	
7	RES		ANY	100 Ohm	4	R1-R4	
8	CONN	99F6798	NEWARK	SMA, 50 Ohm, End Launch	16	SMA1-SMA16	
9	IC		NAT	2 GHz 4 Channel Buffer/Repeater	1	U1	

PCB Stack Up



6

5

4

3

2

1

REVISION RECORD			
LTR:	ECO NO:	APPROVED:	DATE:

D

D

C

C

B

B

A

A

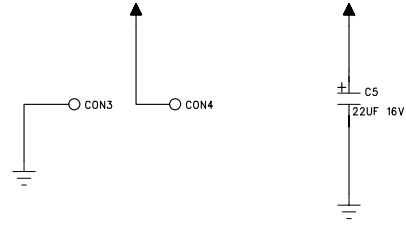
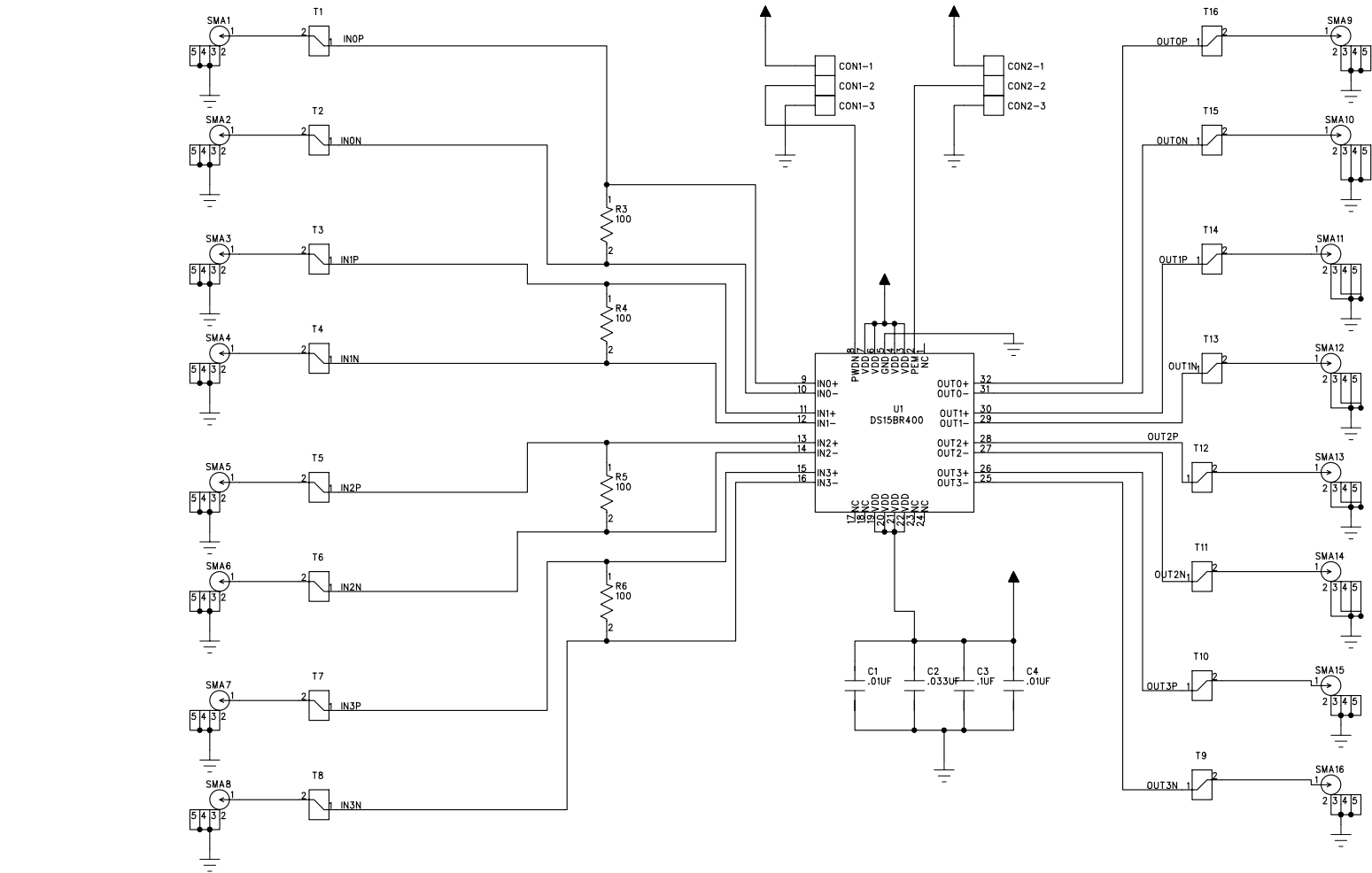

- M1
- M2
- M3
- M4
- M5
- M6
- M7
- M8
- M9
- M11

		25 NorthBrook Drive Gray, Maine 04039 U.S.A.		COMPANY: NATIONAL SEMICONDUCTOR	
DRAWN: ACF		DATED: 6/14/06		TITLE: SCHEMATIC	
CHECKED:		DATED:		CODE:	SIZE: C
QUALITY CONTROL:		DATED:		DRAWING NO: S-05136	REV: 0
RELEASED:		DATED:		SCALE:	SHEET: 1 OF 1

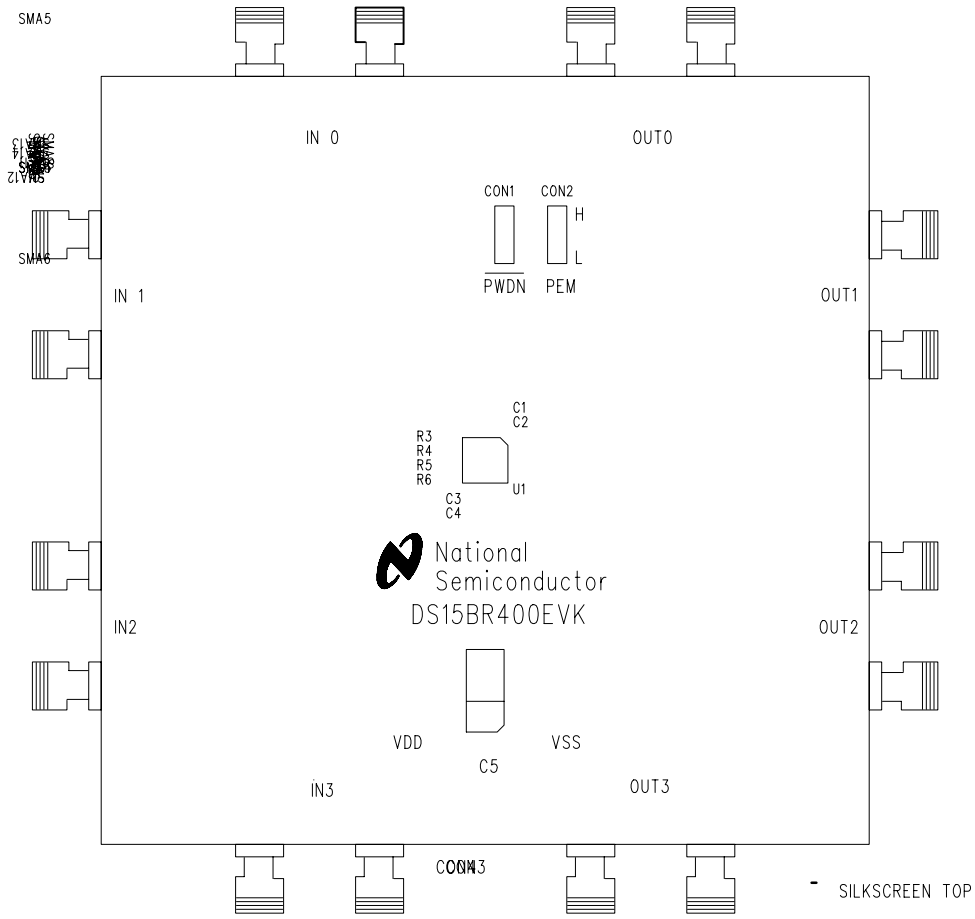

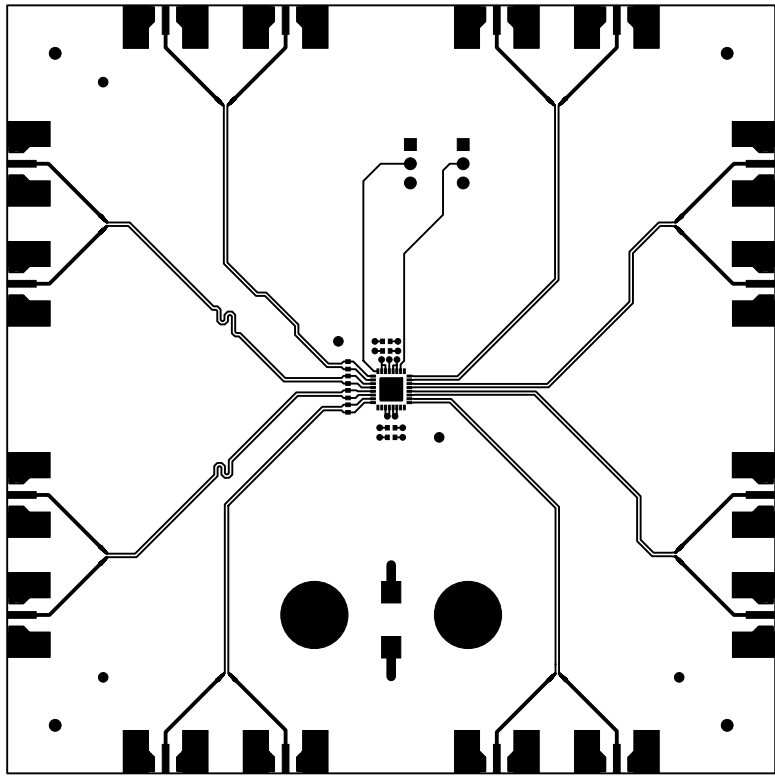

LAYER 1- TOP

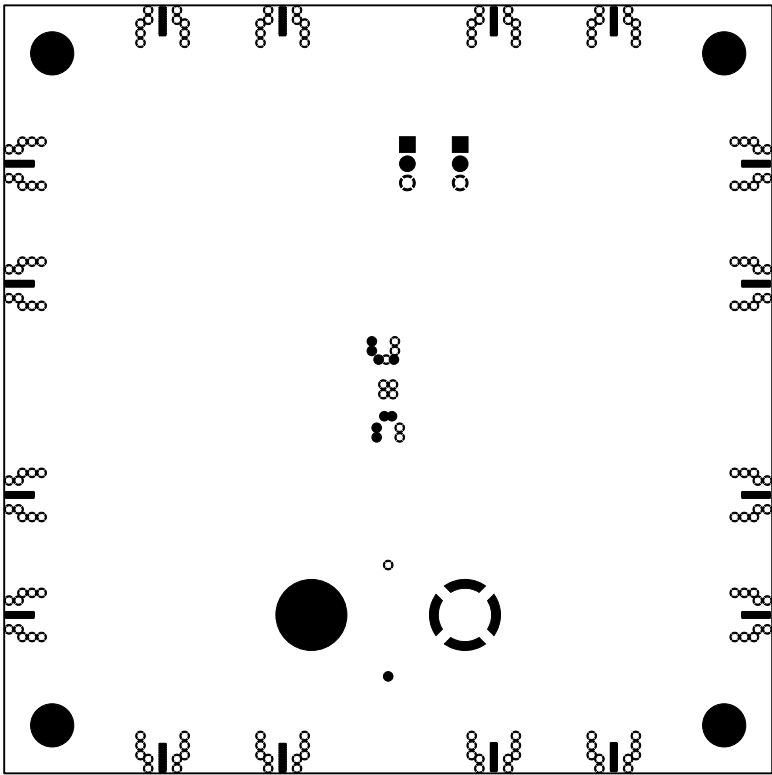

- LAYER 2 GND PLANE

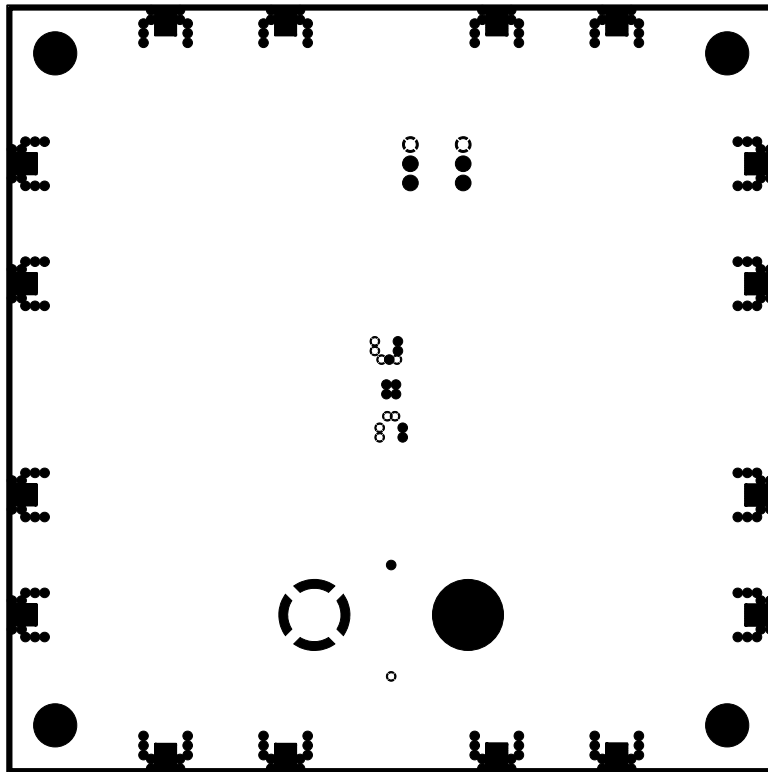

- LAYER 3 VCC PLANE

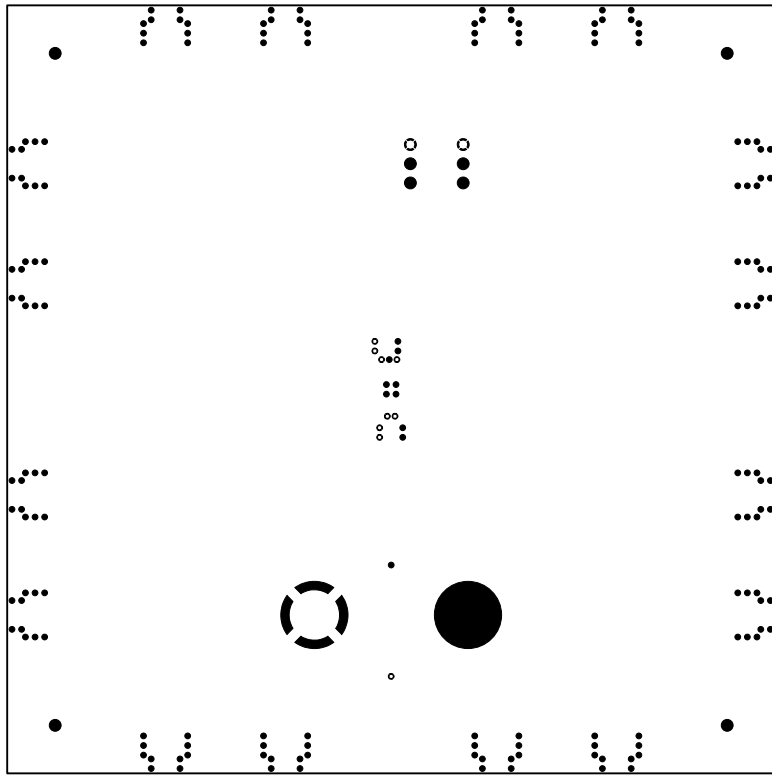

- LAYER 4 VCC PLANE

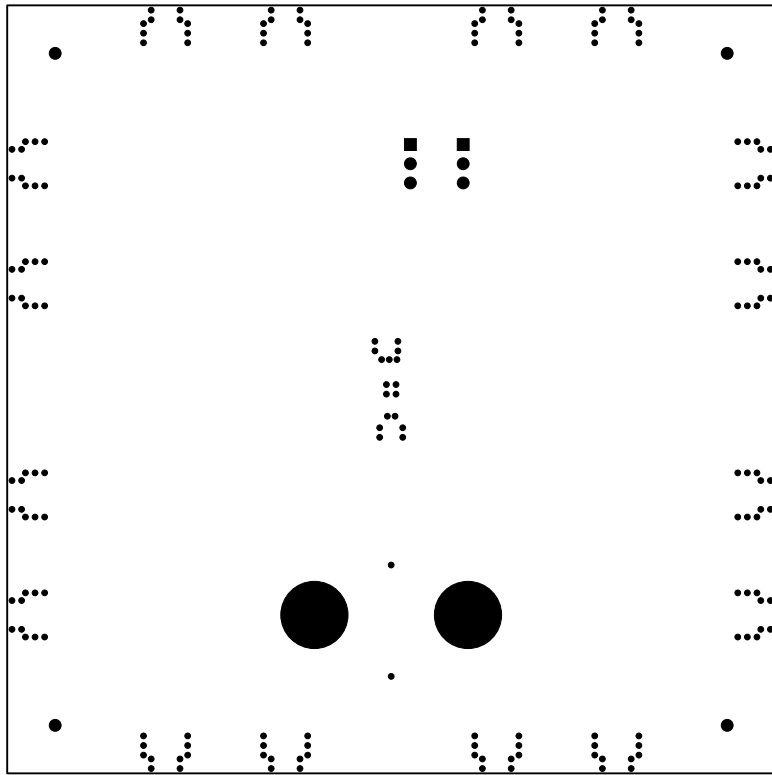

- LAYER 5 GND PLANE

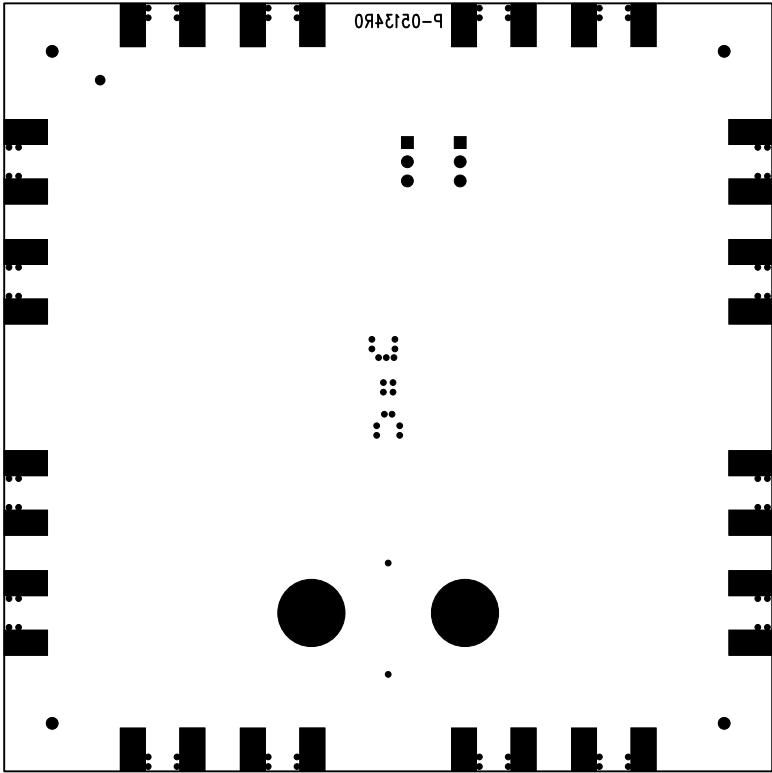

LAYER 4 - BOTTOM

IMPORTANT NOTICE

Texas Instruments Incorporated and its subsidiaries (TI) reserve the right to make corrections, modifications, enhancements, improvements, and other changes to its products and services at any time and to discontinue any product or service without notice. Customers should obtain the latest relevant information before placing orders and should verify that such information is current and complete. All products are sold subject to TI's terms and conditions of sale supplied at the time of order acknowledgment.

TI warrants performance of its hardware products to the specifications applicable at the time of sale in accordance with TI's standard warranty. Testing and other quality control techniques are used to the extent TI deems necessary to support this warranty. Except where mandated by government requirements, testing of all parameters of each product is not necessarily performed.

TI assumes no liability for applications assistance or customer product design. Customers are responsible for their products and applications using TI components. To minimize the risks associated with customer products and applications, customers should provide adequate design and operating safeguards.

TI does not warrant or represent that any license, either express or implied, is granted under any TI patent right, copyright, mask work right, or other TI intellectual property right relating to any combination, machine, or process in which TI products or services are used. Information published by TI regarding third-party products or services does not constitute a license from TI to use such products or services or a warranty or endorsement thereof. Use of such information may require a license from a third party under the patents or other intellectual property of the third party, or a license from TI under the patents or other intellectual property of TI.

Reproduction of TI information in TI data books or data sheets is permissible only if reproduction is without alteration and is accompanied by all associated warranties, conditions, limitations, and notices. Reproduction of this information with alteration is an unfair and deceptive business practice. TI is not responsible or liable for such altered documentation. Information of third parties may be subject to additional restrictions.

Resale of TI products or services with statements different from or beyond the parameters stated by TI for that product or service voids all express and any implied warranties for the associated TI product or service and is an unfair and deceptive business practice. TI is not responsible or liable for any such statements.

TI products are not authorized for use in safety-critical applications (such as life support) where a failure of the TI product would reasonably be expected to cause severe personal injury or death, unless officers of the parties have executed an agreement specifically governing such use. Buyers represent that they have all necessary expertise in the safety and regulatory ramifications of their applications, and acknowledge and agree that they are solely responsible for all legal, regulatory and safety-related requirements concerning their products and any use of TI products in such safety-critical applications, notwithstanding any applications-related information or support that may be provided by TI. Further, Buyers must fully indemnify TI and its representatives against any damages arising out of the use of TI products in such safety-critical applications.

TI products are neither designed nor intended for use in military/aerospace applications or environments unless the TI products are specifically designated by TI as military-grade or "enhanced plastic." Only products designated by TI as military-grade meet military specifications. Buyers acknowledge and agree that any such use of TI products which TI has not designated as military-grade is solely at the Buyer's risk, and that they are solely responsible for compliance with all legal and regulatory requirements in connection with such use.

TI products are neither designed nor intended for use in automotive applications or environments unless the specific TI products are designated by TI as compliant with ISO/TS 16949 requirements. Buyers acknowledge and agree that, if they use any non-designated products in automotive applications, TI will not be responsible for any failure to meet such requirements.

Following are URLs where you can obtain information on other Texas Instruments products and application solutions:

Products

Audio	www.ti.com/audio
Amplifiers	amplifier.ti.com
Data Converters	dataconverter.ti.com
DLP® Products	www.dlp.com
DSP	dsp.ti.com
Clocks and Timers	www.ti.com/clocks
Interface	interface.ti.com
Logic	logic.ti.com
Power Mgmt	power.ti.com
Microcontrollers	microcontroller.ti.com
RFID	www.ti-rfid.com
OMAP Mobile Processors	www.ti.com/omap
Wireless Connectivity	www.ti.com/wirelessconnectivity

Applications

Automotive and Transportation	www.ti.com/automotive
Communications and Telecom	www.ti.com/communications
Computers and Peripherals	www.ti.com/computers
Consumer Electronics	www.ti.com/consumer-apps
Energy and Lighting	www.ti.com/energy
Industrial	www.ti.com/industrial
Medical	www.ti.com/medical
Security	www.ti.com/security
Space, Avionics and Defense	www.ti.com/space-avionics-defense
Video and Imaging	www.ti.com/video

TI E2E Community Home Page

e2e.ti.com

Mailing Address: Texas Instruments, Post Office Box 655303, Dallas, Texas 75265
Copyright © 2012, Texas Instruments Incorporated