

AN-2214 TPS92310 Evaluation Module

1 Introduction

The TPS92310 EVM-8W evaluation module is a constant current output LED driver supporting 5W to 8W applications. The design focuses on applications that require small form factor and minimal number of external components. The actual PCB dimension of the module is only 22mm x 55mm x 19mm (L x W x H). The module can work with AC line input from 90 to 132V_{RMS} or 180 to 264V_{RMS} and supplying 350mA current into a single string of LEDs, typically 6-7 LEDs in series. The evaluation board is carefully designed to comply with major industrial EMC and safety requirements. The user can make use of the information provided in this document, *Dual Hot-Swap Power Controllers with Interdependent Circuit Breaker and Power-Good Reporting* ([SLVS275](#)) data sheet and application notes to design its specific end product easily.

2 Description

The TPS92310 EVM-8W is developed with the TPS92310 controller IC. The TPS92310 is a single-stage AC/DC controller dedicated for LED Lighting applications. The controller uses a primary-side current sense configuration to control the LED current at secondly side. The system works in Critical Conduction Mode (CRM) with flyback topology and it employs a constant on time modulation scheme. Inherently, systems with this configuration can achieve greater than 0.90 Power Factor (PF) easily. The Power Factor (PF) and line current harmonic performances of the evaluation board are tested and reported in this document. The TPS92310 also integrated various protection features: Over-Voltage Protection (OVP), Thermal Shut Down (TSD) and cycle-by-cycle Over-Current Protection (OCP). With these features in place, the system is well protected against open and short circuit of the LEDs string. Considering with the EMI problem, the TPS92310 integrates an internal delay timer to improve it. The delay time can be programmed through an external resistor, it can ensures the controller switch ON the MOSFET only when the MOSFET's drain voltage at its lowest point. The Quasi-resonant switching operation improves the EMI and system efficiency significantly.

3 Typical Applications

LED Lamps:

- A19 (E26/27, E14)
- PAR30/38
- GU10

Domestic and Office SSL solutions:

- Down Light
- LED Panel Light
- Ceiling Lamp Troffer
- T8 Tube

Features

- Application input voltage: $90V_{RMS}$ - $132V_{RMS}$ or $180V_{RMS}$ - $264V_{RMS}$
- **Primary side** Fly-back LED current regulation
- **Adaptive ON-time** control with inherent PFC
- **Critical-Conduction-Mode (CRM)** with **Zero-Current Detect (ZCD)** for valley switching
- **Quasi-resonant switching** to benefit the EMI and efficiency
- **Programmable** FET Switch-On-Delay
- **Constant ON-Time (COT)** and Peak Current Mode (PCM)
- LED current setting with external sense resistor

4 Electrical Performance Specifications
Table 1. 230VAC Evaluation Board (TPS92310 230V EVM)

PARAMETER	TEST CONDITIONS	Min	Typ	Max	Units
Input Characteristics					
	Voltage range	180		264	V_{RMS}
	Input current when VAC = $220V_{RMS}$, $V_{LED}=20V$	-	38	-	mA
Output Characteristics					
	Output voltage, V_{LED}		21		V
	Output load current, I_{LED}	330	350	370	mA
	Output over voltage	-	26	-	V
Systems Characteristics					
	Full load efficiency ($P_{IN} = 8W$)	83	85	-	%
	Full load Power Factor ($P_{IN} = 8W$)	-	>0.9	-	

Table 2. 120VAC Evaluation Board (TPS92310 120V EVM)

PARAMETER	TEST CONDITIONS	Min	Typ	Max	Units
Input Characteristics					
	Voltage range	90		132	V_{RMS}
	Input current when VAC = $220V_{RMS}$, $V_{LED}=20V$	-	75	-	mA
Output Characteristics					
	Output voltage, V_{LED}		21		V
	Output load current, I_{LED}	330	350	370	mA
	Output over voltage	-	26	-	V
Systems Characteristics					
	Full load efficiency ($P_{IN} = 8W$)	82	85	-	%
	Full load Power Factor ($P_{IN} = 8W$)	-	>0.9	-	

5 Schematic (TPS92310 120V EVM / TPS92310 230V EVM)

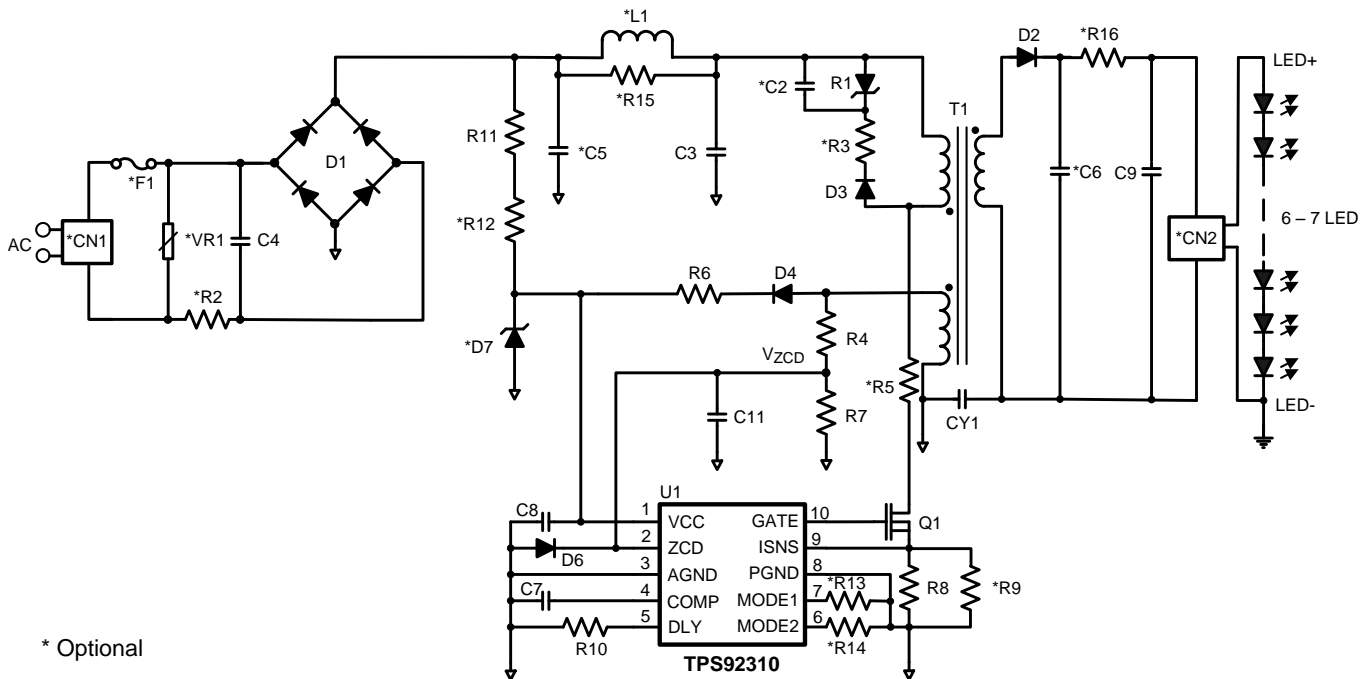

Figure 1. Standard Schematic for the TPS92310 Evaluation Board

5.1 Test Equipment

Voltage Source: Start at $90V_{RMS}$ - $140V_{RMS}$ or $180V_{RMS}$ - $264V_{RMS}$; AC source: PCR500LA (KIKUSUI)

Multimeter: Agilent 34401A

Power meter: WT210 Digital Power Meter (YOKOGAWA)

Output Load: 7 LEDs in series (LED forward voltage =3.0 V at 350 mA) or $V_{LED} = 21V$

Oscilloscope: TDS3054C (TEKTRONIX)

Operation temperature : 25°C

6 Board Connection

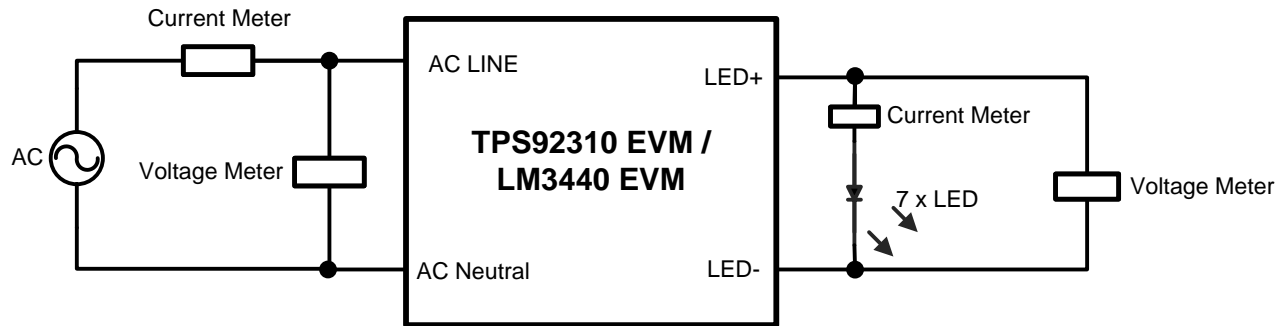

Figure 2. Typical Connection Block Diagram

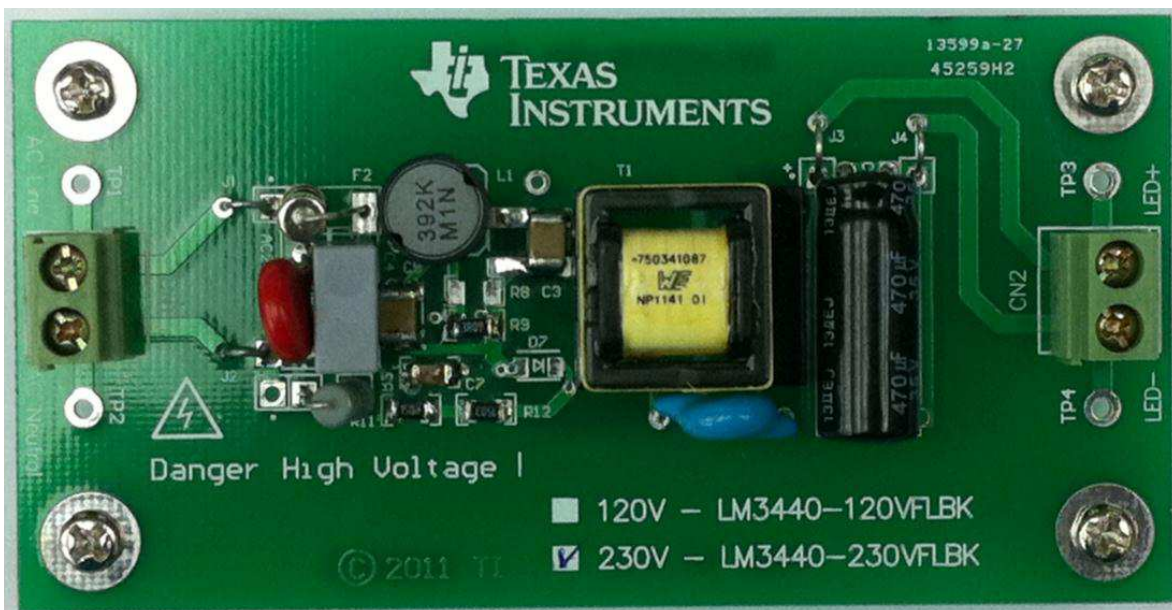

Figure 3. TPS92310EVM_8W

Terminal Designation	Description
AC Live	Connect 230V _{AC} or 120V _{AC} to the board (TPS92310 120V EVM = 120V _{AC} , TPS92310 230V EVM = 230V _{AC})
AC Neutral	
LED+	Connect to the LED + of the LED string
LED-	Connect to the LED - of the LED string

7 TPS92310 Evaluation Board Test Procedure

CAUTION

High voltage levels are present on the evaluation module whenever it is energized. Proper precautions must be taken when working with the EVM. Serious injury can occur if proper safety precautions are not followed.

Table 3. Connections

Step	Operation	Remarks
1	Confirm the demo boards version. (120V _{AC} TPS92310 120V EVM or 230V _{AC} TPS92310 230V EVM)	Check the demo board.
2	Connect the AC source to AC line	AC source voltage is 230V _{AC} TPS92310 230V EVM /120V _{AC} TPS92310 120V EVM
3	Connect the LED light or electronic load to connector LED+ and LED-. (Figure 3)	If use electronic load, set the electronic load is 20V with CV mode. And make sure the LED + connect to electronic load + and LED- connection electronic load GND.

Table 4. Functional AC Input Test

Step	Operation	Remarks
4	Switch the power switch on the setup to ON position.	Please confirm the AC1 and AC2 connection are correct.
5	The LEDs lights up within 2 sec. Measure the convertor output voltage.	The LED voltage is 21V. I _{LED} current is 350mA +/- 5% (electronic load loading value). If the V _{LED} start up <2 sec, Power Factor >0.9 and I _{LED} between 330mA to 370mA
6	Switch off the power source.	Don't touching any connection within 2 sec after power off.

8 Typical Performance Characteristics (TPS92310 230V EVM (230VAC) / TPS92310 120V EVM (120VAC))

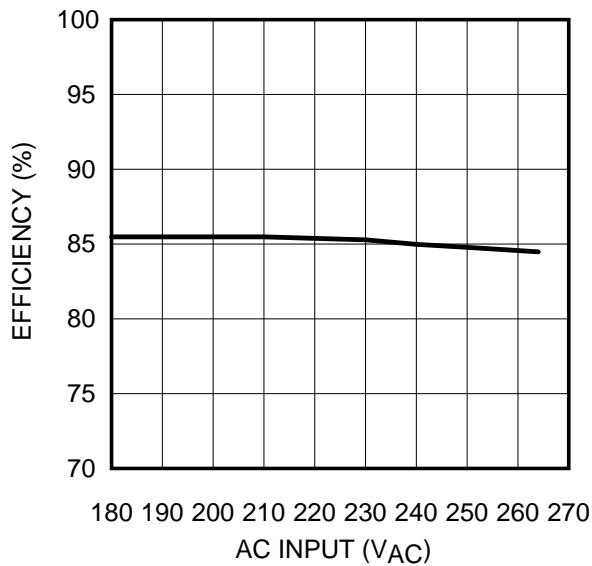

Figure 4. Efficiency vs AC Input

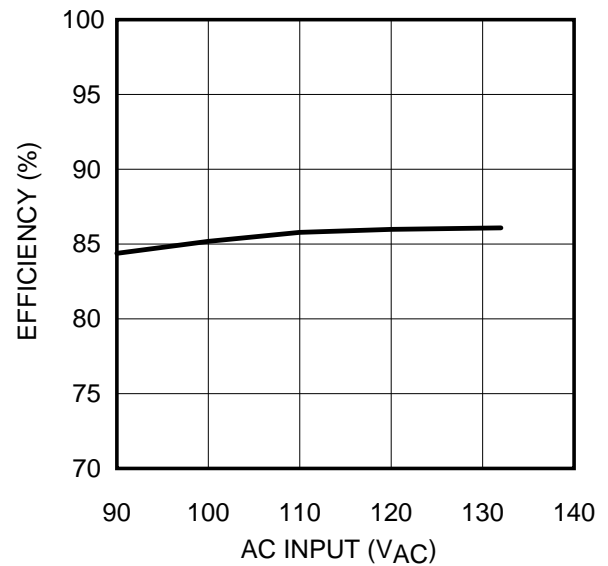

Figure 5. Efficiency vs AC Input

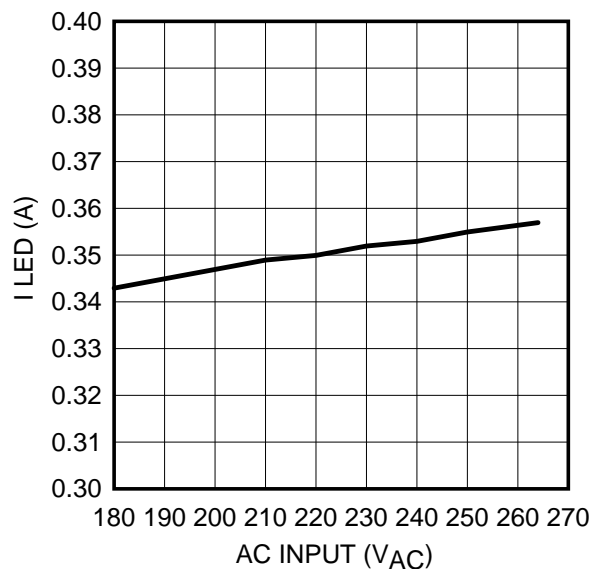

Figure 6. Line Regulation

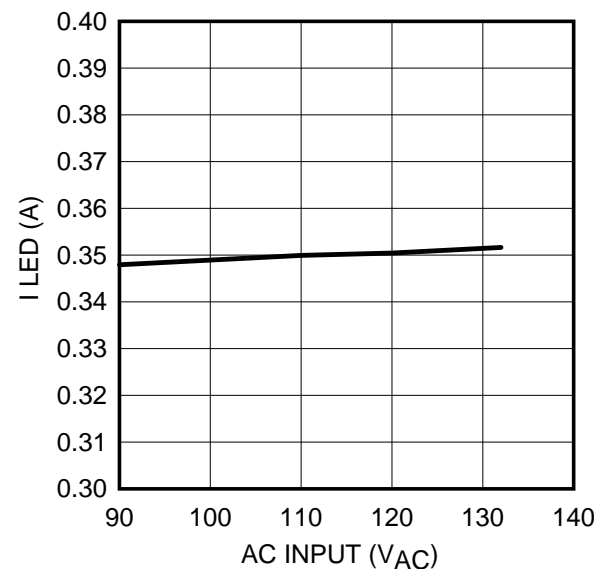

Figure 7. Line Regulation

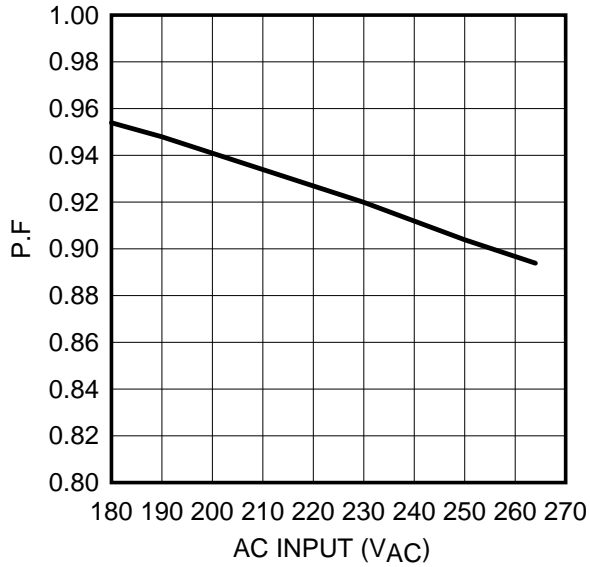

Figure 8. Power Factor

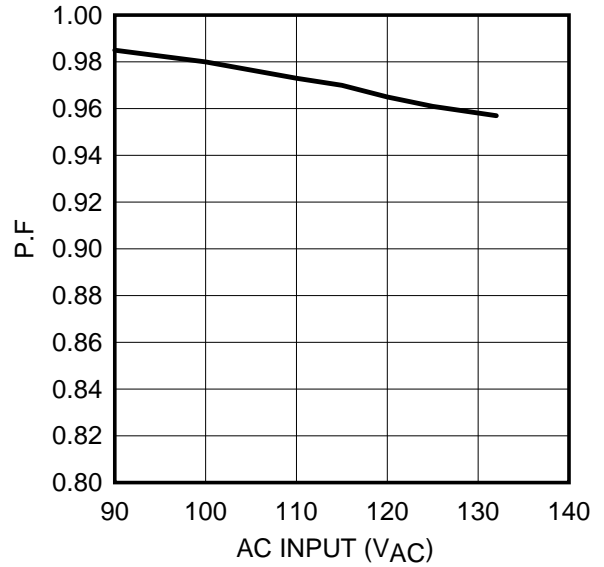

Figure 9. Power Factor

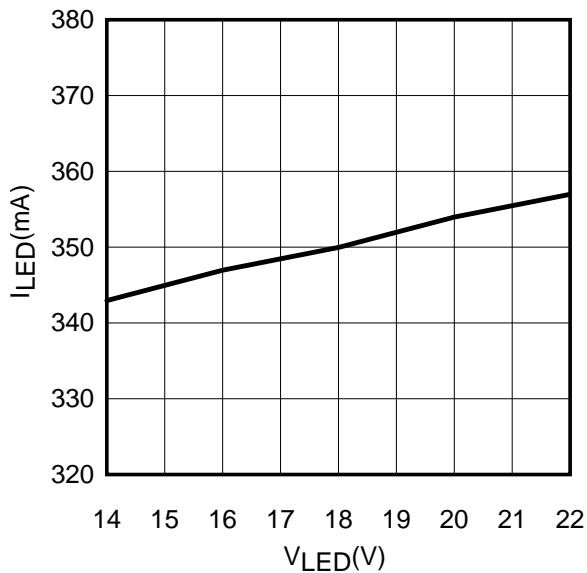

Figure 10. Load Regulation (230VAC)

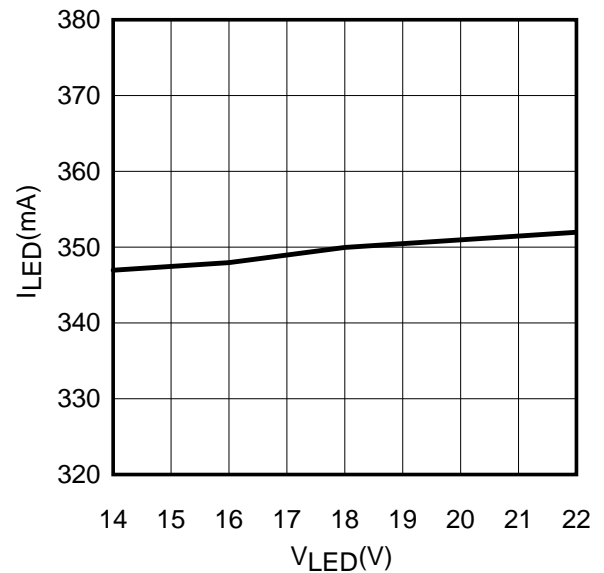

Figure 11. Load Regulation (120VAC)

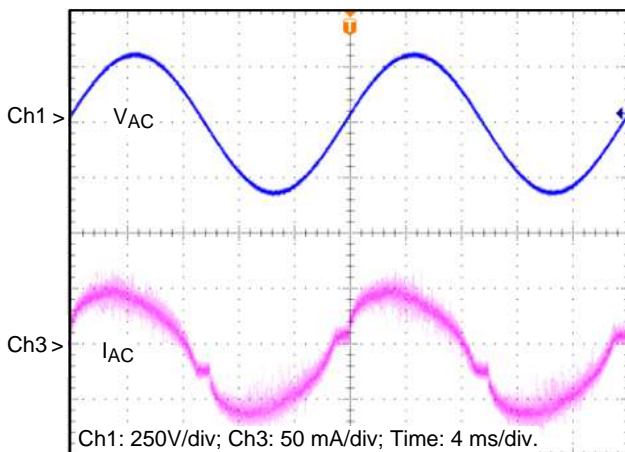

Figure 12. Input Voltage and Input Current (230VAC)

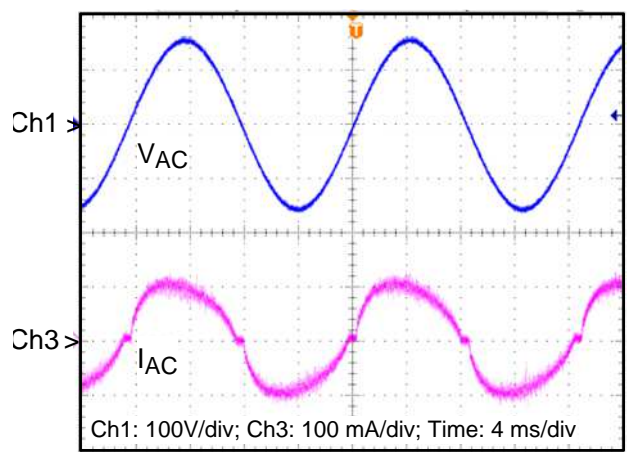
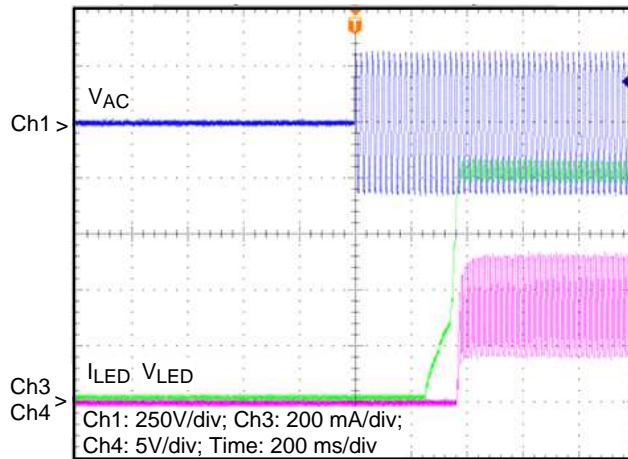
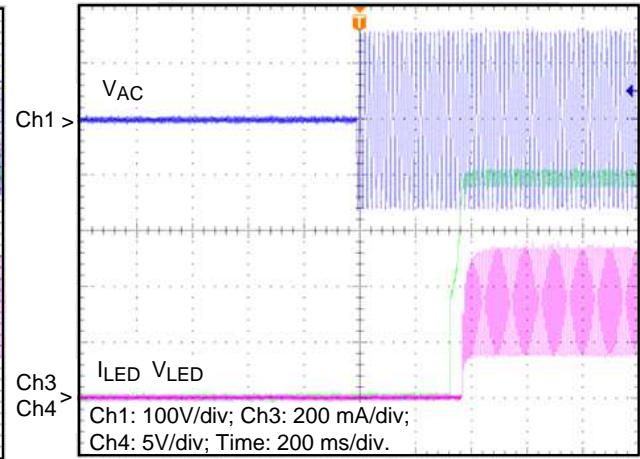
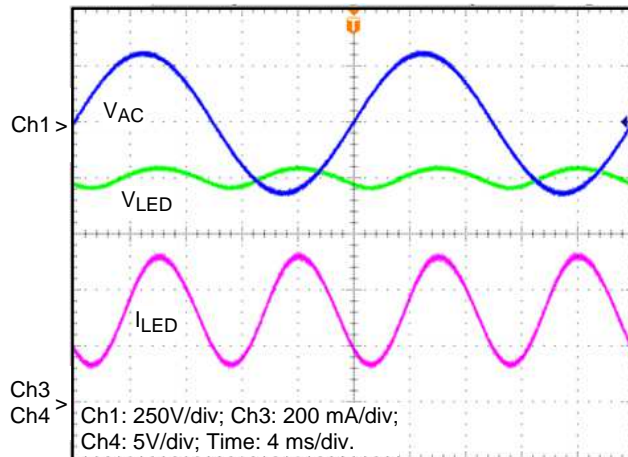
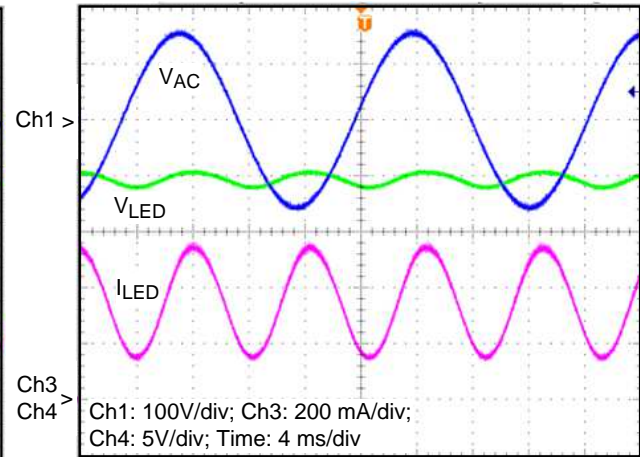

Figure 13. Input Voltage and Input Current (120VAC)

Figure 14. Power Up Output Voltage and Current (230VAC)

Figure 15. Power Up Output Voltage and Current (120VAC)

Figure 16. Output Current and Voltage Waveforms (230VAC)

Figure 17. Output Current and Voltage Waveforms (120VAC)

9 Current Harmonic Information

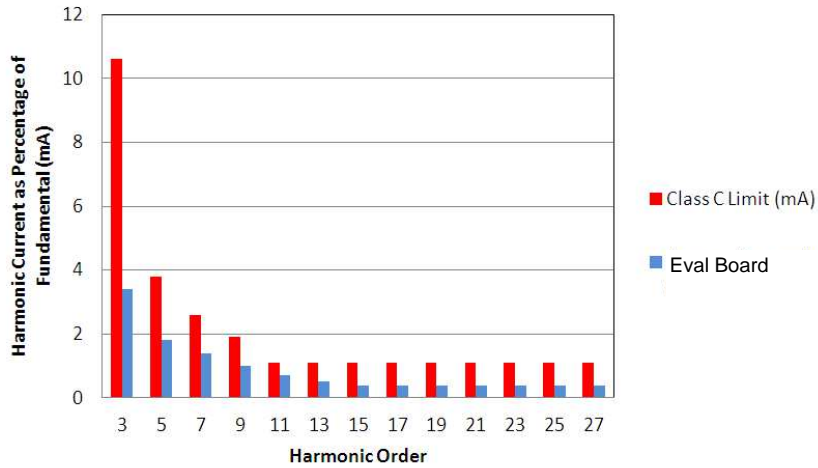

Figure 18. TPS92310 120V EVM Current Harmonic vs IEC61000–3–2 Class C Limits

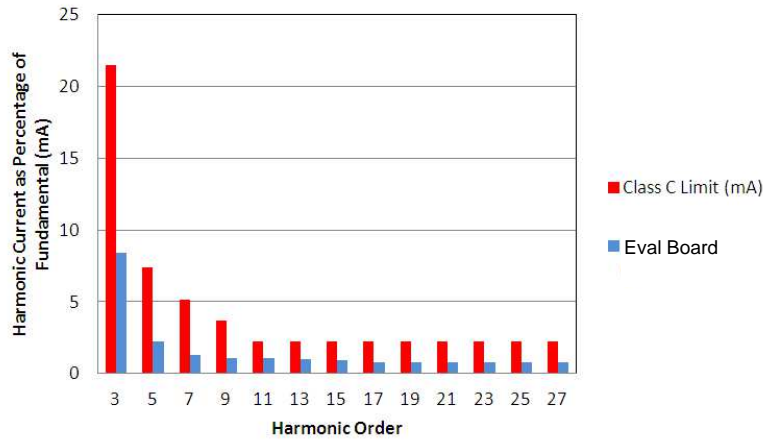

Figure 19. TPS92310 230V EVM Current Harmonic vs IEC61000–3–2 Class C Limits

10 Electromagnetic Interference (EMI)

In order to get quick estimation of the EMI filter performance, only PEAK conductive EMI scan was measured and the data was compared with the EN 55022 Class B conducted EMI Limits. All test conditions are under $P_{IN}=8W$ full load.

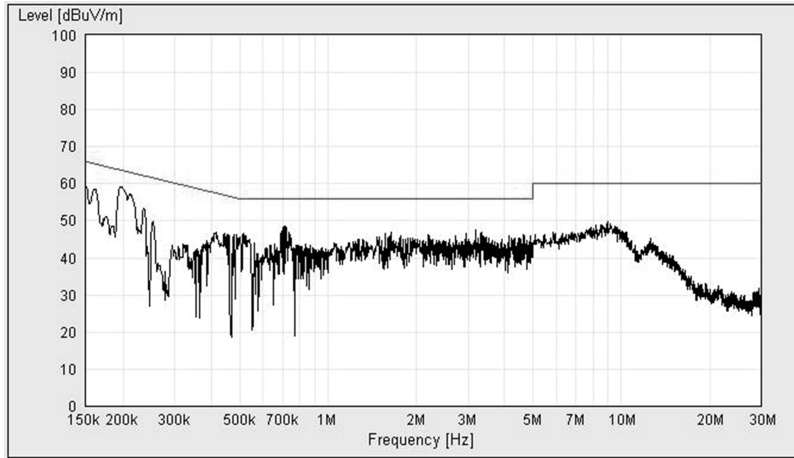

Figure 20. Peak Conductive EMI per EN55022, Class B Limits (110VAC Live)

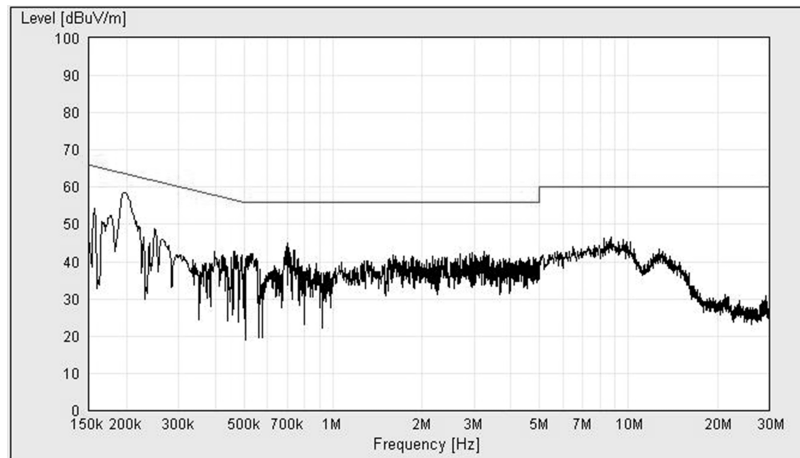

Figure 21. Peak Conductive EMI per EN55022, Class B Limits (110VAC Neutral)

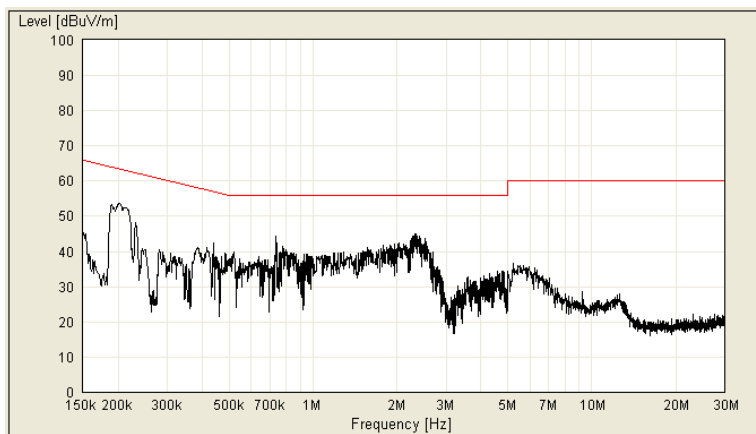

Figure 22. Peak Conductive EMI per EN55022, Class B Limits (230VAC Live)

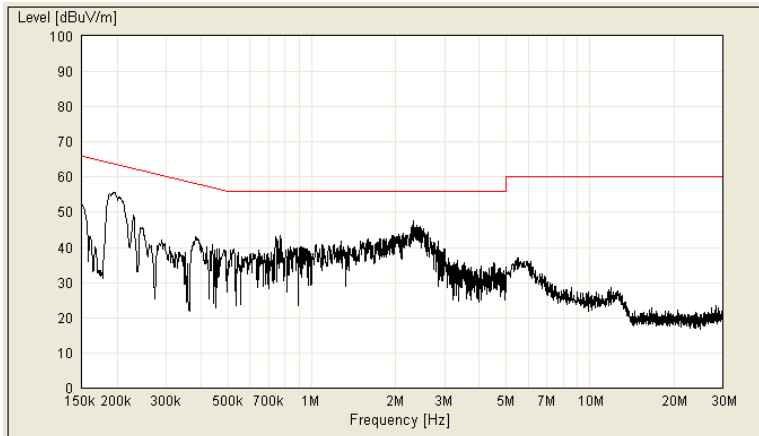

Figure 23. Peak Conductive EMI per EN55022, Class B Limits (230VAC Neutral)

10.1 EVM Assembly Drawing and PCB Layout

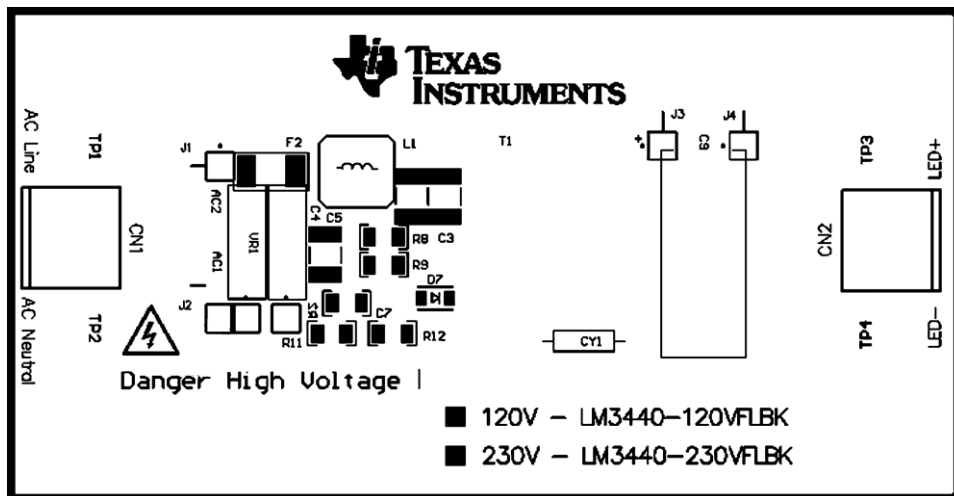

Figure 24. Top Layer Assembly Drawing (Top View)

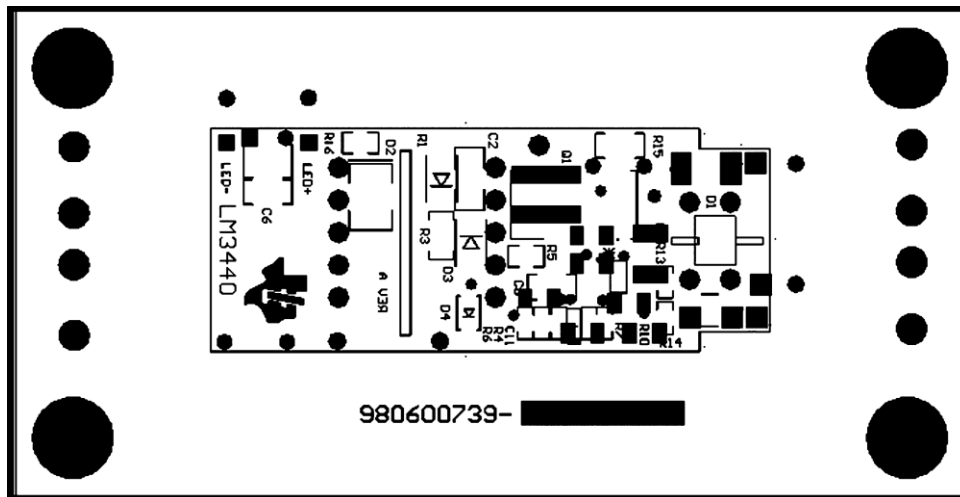

Figure 25. Bottom Layer Assembly Drawing (Bottom View)

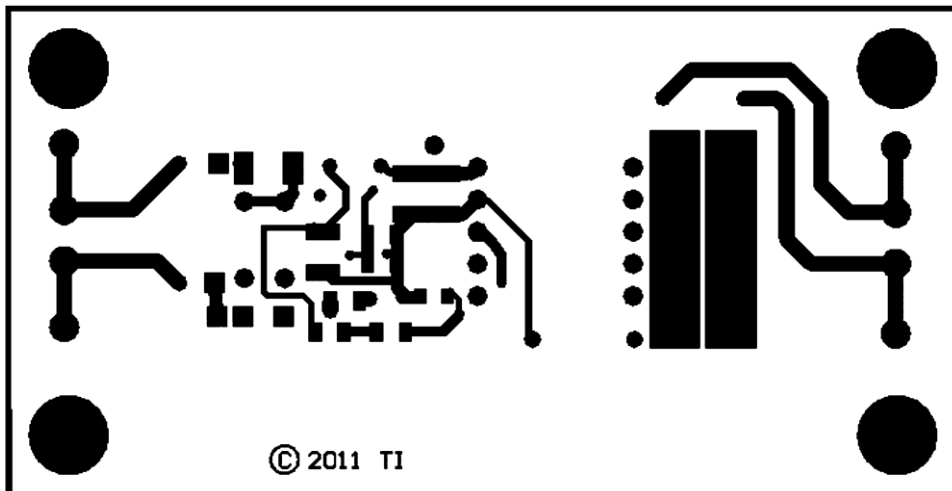

Figure 26. Top Layer Copper (Top View)

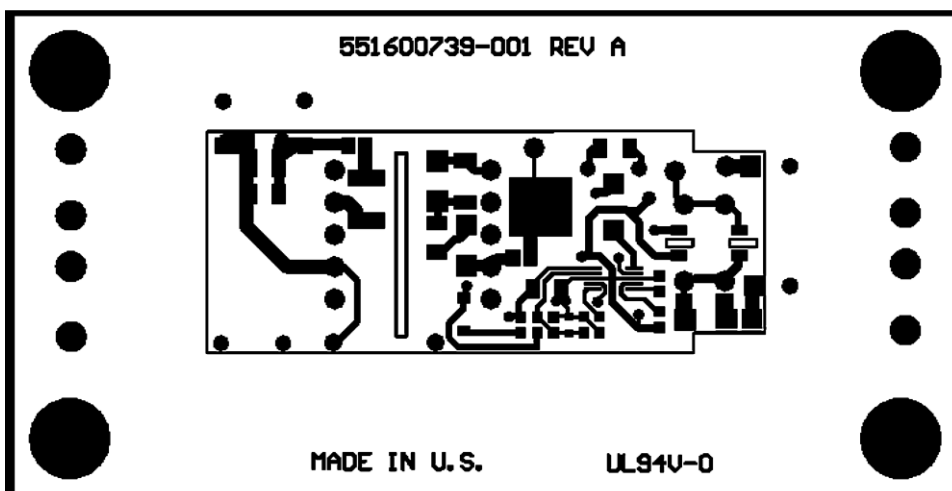

Figure 27. Bottom Layer Copper (Bottom View)

11 Bill of Materials TPS92310 Evaluation Board (TPS92310 230V EVM)

Item	Designator	Description	Manufacturer	Part Number
1	PCB	Printed Circuit Board		551600739-001 REV A
2	U1	TPS92310	TI	TPS92310
3	C3, C5	CAP CER .1 μ F 630V 10% X7R 1812	Murata Electronics North America	GRM43DR72J104KW01L
4	C4	CAP 47000PF 310VAC EMI SUPPRESSN	Vishay/BC Components	BFC233920473
5	C9	CAP ALUM 470 μ F 35V 20% RADIAL	Panasonic - ECG	EEU-FR1V471L
6	C6, C8	CAP, CERM, 10 μ F, 50V, X7R, [1210], CAP CER X7R 1210	Murata	GRM32ER71H106KA12L
7	C7	CAP CER 2.2 μ F 50V X7R 0805	Murata	GRM21BR71A225KA01L
8	C11	CAP CER 15p 50V 0603	Murata	GRM1885C1H150JA01D
9	CY1	CAP CER 2200PF 250VAC X1Y1 RAD	Murata	DE1E3KX222MA4BL01
10	D1	RECT BRIDGE GP 600V 0.8A MINIDIP	Diodes Inc	HD06-T
11	D2	DIODE SCHOTTKY 100V 1A SMA	Diodes Inc	B1100-13-F
12	D3	DIODE GPP ULTRA FAST 1A 600V SMA	Vishay/General Semiconductor	US1J-E3/61T
13	D4	Default Diode	Diodes Inc	BAV20W-7-F
14	D5	Zener Diode	Littelfuse Inc	SMAJ250ALFCT-ND
15	D6	General Purpose diode	Comchip Technology	CDSU4148
16	Q1	MOSFET N-CH 800V 2.5A DPAK	STMicroelectronics	STD3NK80ZT4
17	R1	NC	NC	NC
18	R2	RES 47 OHM 1W 5% METAL FILM AX (230VAC)	Yageo	FMP100JR-52-47R
19	R3	RES, 1.00k ohm, 1%, 0.25W, 1206	Vishay/Dale	CRCW12061K10FKEA
20	R4	RES, 66.5k ohm, 1%, 0.1W, 0603	Vishay/Dale	CRCW060366K5FKEA
21	R5	RES 0.0 OHM 1/8W 0805 SMD	Vishay/Dale	CRCW08050000Z0EA
22	R6	RES, 20.0 ohm, 1%, 0.1W, 0603	Vishay/Dale	CRCW060320R0JNEA
23	R7	RES, 11.0k ohm, 1%, 0.1W, 0603	Vishay/Dale	CRCW060311K0FKEA
24	R8	3.3 Ohm (230VAC)	Panasonic - ECG	ERJ-8GEYJ3R3V
25	R9	51 Ohm (230VAC)	Panasonic - ECG	ERJ-8GEYJ510V
26	R10	RES, 18.0k ohm, 1%, 0.1W, 0603	Vishay/Dale	CRCW060318K0JNEA
27	R11	200KOhm, 5%. 0.25W 1206	Vishay/Dale	CRCW1206200KJNEA
28	R12	200KOhm, 5%. 0.25W 1206	Vishay/Dale	CRCW1206200KJNEA
29	R13	NC	NC	NC
30	R14	NC	NC	NC
31	R15	NC	NC	NC
32	R16	RES 0.0 OHM 1/8W 0805 SMD	Vishay/Dale	CRCW08050000Z0EA
33	VR1	VARISTOR 300V 30J 7MM EPCOS	EPCOS Inc	S07K300E2
34	L1	Inductor 4.7mH	Sumida	RCH895 00777-T048-332
35	T1	750341087 REV 2.0	Würth	750341087 REV 2.0
36	F1	FUSE SLOW BLOW 0.5A	Littelfuse Inc	0677.500MXE
37	H1, H2, H5, H6	Standoff, Hex, 0.5"L #4-40 Nylon	Keystone	1902C
38	H3, H4, H7, H8	Machine Screw, Round, #4-40 x 1/4, Nylon, Philips panhead	B&F Fastener Supply	NY PMS 440 0025 PH
39	CN1, CN2	Conn Term Block, 2POS, 5.08mm PCB	Phoenix Contact	1715721
40	TP1, TP2, TP3, TP4	Terminal, Turret, TH, Double	Keystone Electronics	1502-2

12 Bill of Materials TPS92310 Evaluation Board (TPS92310 120V EVM)

Item	Designator	Description	Manufacturer	PartNumber
1	PCB	Printed Circuit Board		551600739-001 REV A
2	U1	TPS92310	TI	TPS92310
3	C3, C5	CAP CER .1µF 630V 10% X7R 1812	Murata Electronics North America	GRM43DR72J104KW01L
4	C4	CAP 47000PF 310VAC EMI SUPPRESSN	Vishay/BC Components	BFC233920473
5	C9	CAP ALUM 470µF 35V 20% RADIAL	Panasonic - ECG	EEU-FR1V471L
6	C6, C8	CAP, CERM, 10µF, 50V, XR7 ,[1210], CAP CER X7R 1210	Murata	GRM32ER71H106KA12L
7	C7	CAP CER 2.2µF 50V X7R 0805	Murata	GRM21BR71A225KA01L
8	CY1	CAP CER 2200PF 250VAC X1Y1 RAD	Murata	DE1E3KX222MA4BL01
9	C11	CAP CER 15p 50V 0603	Murata	GRM1885C1H150JA01D
10	D1	RECT BRIDGE GP 600V 0.8A MINIDIP	Diodes Inc	HD06-T
11	D2	DIODE SCHOTTKY 100V 1A SMA	Diodes Inc	B1100-13-F
12	D3	DIODE GPP ULTRA FAST 1A 600V SMA	Vishay/General Semiconductor	US1J-E3/61T
13	D4	Default Diode	Diodes Inc	BAV20W-7-F
14	D5	Zener Diode	Littelfuse Inc	SMAJ250ALFCT-ND
15	D6	General Purpose diode	Comchip Technology	CDSU4148
16	Q1	MOSFET N-CH 800V 2.5A DPAK	STMicroelectronics	STD3NK80ZT4
17	R1	NC	NC	NC
18	R2	RES 22 OHM 1W 5% METAL FILM AX	Yageo	FMP100JR-52-22R
19	R3	RES, 1.00k ohm, 1%, 0.25W, 1206	Vishay/Dale	CRCW12061K10FKEA
20	R4	RES, 66.5k ohm, 1%, 0.1W, 0603	Vishay/Dale	CRCW060366K5FKEA
21	R5	RES 0.0 OHM 1/8W 0805 SMD	Vishay/Dale	CRCW08050000Z0EA
22	R6	RES, 20.0 ohm, 1%, 0.1W, 0603	Vishay/Dale	CRCW060320R0JNEA
23	R7	RES, 11.0k ohm, 1%, 0.1W, 0603	Vishay/Dale	CRCW060311K0FKEA
24	R8	1.5 Ohm 1206	Panasonic - ECG	ERJ-8GEYJ1R5V
25	R9	36 Ohm 1206	NC	ERJ-8GEYJ360V
26	R10*	RES, 6.34k ohm, 1%, 0.1W, 0603	Vishay/Dale	CRCW06036K34FKEA
27	R11	100KOhm, 5%. 0.25W 1206	Vishay/Dale	CRCW1206100KJNEA
28	R12	100KOhm, 5%. 0.25W 1206	Vishay/Dale	CRCW1206100KJNEA
29	R13	NC	NC	NC
30	R14	NC	NC	NC
31	R15	NC	NC	NC
32	R16	RES 0.0 OHM 1/8W 0805 SMD	Vishay/Dale	CRCW08050000Z0EA
33	VR1	VARISTOR 300V 30J 7MM EPCOS	EPCOS Inc	S07K300E2
34	L1	Inductor 3.3mH	Sumida	RCH895 00777-T048-332
35	T1	750341086 REV 2.0	Würth	750341086 REV 2.0
36	F1	FUSE SLOW BLOW 0.5A	Littelfuse Inc	0677.500MXE
37	H1, H2, H5, H6	Standoff, Hex, 0.5"L #4-40 Nylon	Keystone	1902C
38	H3, H4, H7, H8	Machine Screw, Round, #4-40 x 1/4, Nylon, Philips panhead	B&F Fastener Supply	NY PMS 440 0025 PH
39	CN1, CN2	Conn Term Block, 2POS, 5.08mm PCB	Phoenix Contact	1715721
40	TP1, TP2, TP3, TP4	Terminal, Turret, TH, Double	Keystone Electronics	1502-2

IMPORTANT NOTICE

Texas Instruments Incorporated and its subsidiaries (TI) reserve the right to make corrections, enhancements, improvements and other changes to its semiconductor products and services per JESD46, latest issue, and to discontinue any product or service per JESD48, latest issue. Buyers should obtain the latest relevant information before placing orders and should verify that such information is current and complete. All semiconductor products (also referred to herein as "components") are sold subject to TI's terms and conditions of sale supplied at the time of order acknowledgment.

TI warrants performance of its components to the specifications applicable at the time of sale, in accordance with the warranty in TI's terms and conditions of sale of semiconductor products. Testing and other quality control techniques are used to the extent TI deems necessary to support this warranty. Except where mandated by applicable law, testing of all parameters of each component is not necessarily performed.

TI assumes no liability for applications assistance or the design of Buyers' products. Buyers are responsible for their products and applications using TI components. To minimize the risks associated with Buyers' products and applications, Buyers should provide adequate design and operating safeguards.

TI does not warrant or represent that any license, either express or implied, is granted under any patent right, copyright, mask work right, or other intellectual property right relating to any combination, machine, or process in which TI components or services are used. Information published by TI regarding third-party products or services does not constitute a license to use such products or services or a warranty or endorsement thereof. Use of such information may require a license from a third party under the patents or other intellectual property of the third party, or a license from TI under the patents or other intellectual property of TI.

Reproduction of significant portions of TI information in TI data books or data sheets is permissible only if reproduction is without alteration and is accompanied by all associated warranties, conditions, limitations, and notices. TI is not responsible or liable for such altered documentation. Information of third parties may be subject to additional restrictions.

Resale of TI components or services with statements different from or beyond the parameters stated by TI for that component or service voids all express and any implied warranties for the associated TI component or service and is an unfair and deceptive business practice. TI is not responsible or liable for any such statements.

Buyer acknowledges and agrees that it is solely responsible for compliance with all legal, regulatory and safety-related requirements concerning its products, and any use of TI components in its applications, notwithstanding any applications-related information or support that may be provided by TI. Buyer represents and agrees that it has all the necessary expertise to create and implement safeguards which anticipate dangerous consequences of failures, monitor failures and their consequences, lessen the likelihood of failures that might cause harm and take appropriate remedial actions. Buyer will fully indemnify TI and its representatives against any damages arising out of the use of any TI components in safety-critical applications.

In some cases, TI components may be promoted specifically to facilitate safety-related applications. With such components, TI's goal is to help enable customers to design and create their own end-product solutions that meet applicable functional safety standards and requirements. Nonetheless, such components are subject to these terms.

No TI components are authorized for use in FDA Class III (or similar life-critical medical equipment) unless authorized officers of the parties have executed a special agreement specifically governing such use.

Only those TI components which TI has specifically designated as military grade or "enhanced plastic" are designed and intended for use in military/aerospace applications or environments. Buyer acknowledges and agrees that any military or aerospace use of TI components which have **not** been so designated is solely at the Buyer's risk, and that Buyer is solely responsible for compliance with all legal and regulatory requirements in connection with such use.

TI has specifically designated certain components as meeting ISO/TS16949 requirements, mainly for automotive use. In any case of use of non-designated products, TI will not be responsible for any failure to meet ISO/TS16949.

Products

Audio	www.ti.com/audio
Amplifiers	amplifier.ti.com
Data Converters	dataconverter.ti.com
DLP® Products	www.dlp.com
DSP	dsp.ti.com
Clocks and Timers	www.ti.com/clocks
Interface	interface.ti.com
Logic	logic.ti.com
Power Mgmt	power.ti.com
Microcontrollers	microcontroller.ti.com
RFID	www.ti-rfid.com
OMAP Applications Processors	www.ti.com/omap
Wireless Connectivity	www.ti.com/wirelessconnectivity

Applications

Automotive and Transportation	www.ti.com/automotive
Communications and Telecom	www.ti.com/communications
Computers and Peripherals	www.ti.com/computers
Consumer Electronics	www.ti.com/consumer-apps
Energy and Lighting	www.ti.com/energy
Industrial	www.ti.com/industrial
Medical	www.ti.com/medical
Security	www.ti.com/security
Space, Avionics and Defense	www.ti.com/space-avionics-defense
Video and Imaging	www.ti.com/video

TI E2E Community

e2e.ti.com